







Return to  
**LIBRARY**

~~~~~  
NATIONAL BUSINESS  
PUBLICATIONS LIMITED







Return to  
**LIBRARY**  
DEPARTMENT  
~~~~~  
NATIONAL BUSINESS  
PUBLICATIONS LIMITED







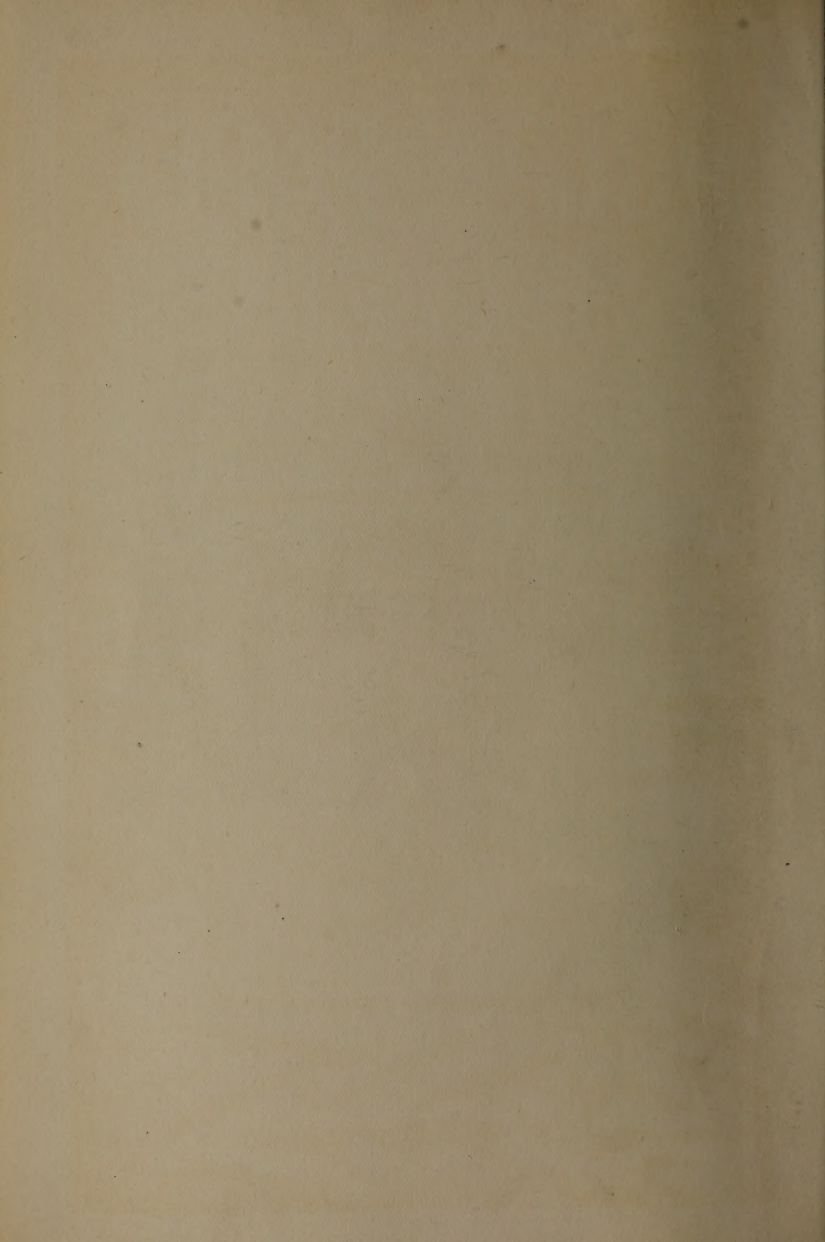



# PULP AND PAPER MAGAZINE

OF CANADA

VOL. IV TORONTO, JANUARY, 1912. NO. 1

## PRINCIPAL CONTENTS

Postal Rates on Periodicals  
containing Samples of Paper.  
The "Favored Nations" and  
Foreign Trade.

Foreign Countries Denied.

New Process of Soda Recovery  
utilizing Material in Paper.

Recovery of Black Liquor in  
Sulphate and Soda Pulp Mills.

Doubling Production of Pulp  
and Paper Mills.

Mould Growths on Wood Pulp.

Method of Making Imitation  
Water Marks.

Established 1837

Incorporated 1867

# RICE, BARTON & FALES

## MACHINE & IRON CO.

CHARLES S. BARTON, *Pres. & Treas*  
GEORGE S. BARTON, *Secretary.*

WORCESTER, MASS.

BUILDERS OF

**Modern Fast Running and Heavy Four-  
drinier and Cylinder Machines for Making  
Paper, and Drying Pulp.**

Double Drum Vertical Winders and Re-Winders.

Upright and Revolving Reels.

Large and Heavy Wet Machines.

Revolving Cutters and Layboys.

Hill Patent Diagonal Cutters, which can be equipped with  
Slitting Arrangement, and Reeling Off Bars.

Chilled Iron Calender Rolls.

Screens and Screen Plates.

Stuff, Suction and Fan Pumps.

Patent Top and Double Edged Slitters.

Pneumatic Re-Winders for Small Rolls.

Additions and Changes made to Old Paper Machines  
Greatly Increasing Speed and Capacity.

## **Sulphite Mill Specialties**



## Jeffrey Storage Battery and Trolley Locomotive

for handling Pulpwood and other material in Pulp and Paper Mills.

**Distinguishing Features:** Can be used when the smoke of a Steam Locomotive would be objectionable. Low cost of maintenance. Consumes power and requires attention only when in actual operation. Can be operated by one man. Ready for use at all times. Write for Industrial Locomotive Bulletin No. 13, giving complete information.

### The Jeffrey Manufacturing Company

Canadian Works and Main Office :  
MONTREAL

1-12

Branch Office :  
WINNIPEG

E. J. WELCH, *President and Managing Director*  
HENRY W. S. DOWNS, *Superintendent*

EMMONS CROCKER, *Vice-President*  
A. S. MORSE, *Secretary and Treasurer*

# SCREEN PLATES

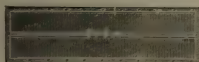

The "Union" Bronze (best phosphorized cast metal) Plates for Sulphite Mills. The Standard Rolled Brass Plates. The "Union" Cast Metal Suction Plates.

We carry a large stock of blanks of the various sizes in both metals and can fill all orders promptly.

Old plates reclosed and recut by our process are practically as good as new and give better results than by any other process.

## Union Screen Plate Co. of Canada, Limited

FACTORY : LENNOXVILLE, QUEBEC.

OFFICES : Lennoxville, Quebec, and Fitchburg, Massachusetts, U. S. A.

# Glens Falls Machine Works

GLENS FALLS, N.Y.



Sole Manufacturers of  
**Tromblee & Paull Rotary Sulphur Burner**

**The Moore Rotary Screen**

**The Reynolds Screen**

Also Manufacture

**Cedar Point Foundry Grinders**

**Improved Standard Grinders**

**Improved Wet Machines**

**Rotary Pumps, etc.**

Write for Particulars and Specifications—they are free.

# DODGE

**Transmission** —\*

—\*— **Machinery**

— **High Grade Only** —

**Shafting, Hangers, Pulleys,  
 Friction Clutch Pulleys.**

**DODGE MANUFACTURING CO.**

640 ST. PAUL ST. HAYMARKET SQUARE **MONTREAL** LIMITED

## J. Marx & Co., London, E. C., England

**BASALT LAVA STONE BEATER ROLLS** The best beater tackle for News, Kraft, Tissue, Board, Grease-Proof, or for Pulp Refining. Over 700 at work.

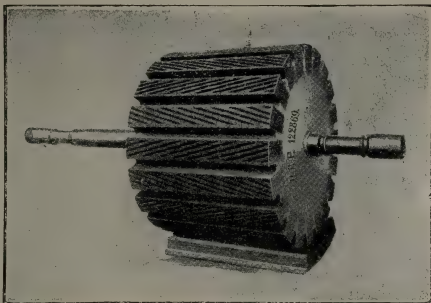

SPECIALTIES Margalt Suction Rolls, Double Beaters, Stone Wet Press Rolls, Basalt Lava Pulp Refiners for Screenings.

Canadian  
Representative

**Judson A. DeCew**

Canadian Express  
Building

**Montreal**

*The*

## Harmon Incline Screening System

Will give greatest capacity.

Will give cleaner stock.

Will save power.

Will save labor.

Does not require use of Rakers.

Write us for full descriptive Catalogue and testimonials from the best mills in the country.

## HARMON MACHINE COMPANY

**WATERTOWN, N. Y. U. S. A.**



## THE EDDY PAPER TESTER

Will register the breaking strength of paper in pounds per square inch—a recognized standard the world over.

**\$15.00 net**  
postpaid.



Is provided with an adjustment whereby the user can reset same, if necessary. Will do the work of higher priced machines and do it quicker. 6 inches high,

### DOBLER & MUDGE

BALTIMORE, MD., U.S.A.

## THE BEST JORDON ENGINE IS BUILT BY THE

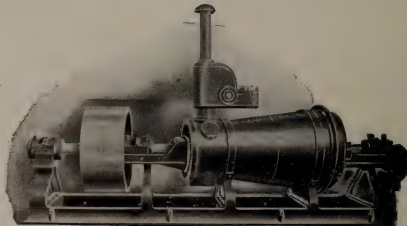

### APPLETON MACHINE CO.

APPLETON, WIS.

SEND FOR PARTICULARS

THE SANDY HILL IRON AND BRASS WORKS, HUDSON FALLS, N.Y.



130" HARPER FOURDRINIER PAPER MACHINE.

This illustration is of the

**Ramsey Patent Single**

1

**Pressure Grinder Valve**

This valve is made also in what we call the **Double Pressure Type** where different pressures are used

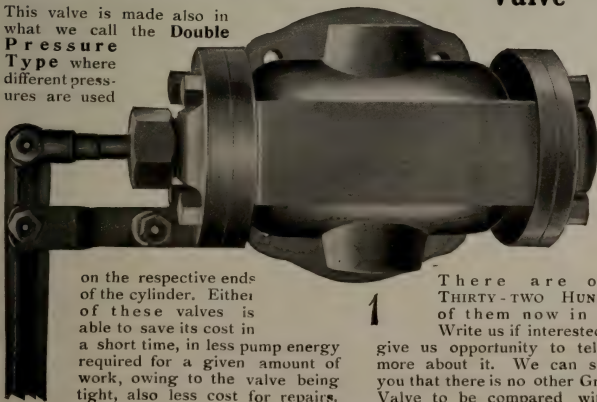

2

on the respective ends of the cylinder. Either of these valves is able to save its cost in a short time, in less pump energy required for a given amount of work, owing to the valve being tight, also less cost for repairs.

1

There are over **THIRTY-TWO HUNDRED** of them now in use. Write us if interested and give us opportunity to tell you more about it. We can satisfy you that there is no other Grinder Valve to be compared with it.

Sole Manufacturers

**BAKER & SHEVLIN CO., - Saratoga Springs, N.Y.**

Telegrams :  
"CALENDER, BURY"

Telephone :  
NUMBER 340

# Bentley & Jackson,

Limited

PAPER MAKERS'

.. ENGINEERS ..

BURY, - - ENGLAND

## *SPECIALITIES.*

MODERN HIGH SPEED NEWS PAPER  
MAKING MACHINES

SINGLE CYLINDER PAPER MAKING  
MACHINES

The NEW "MARSHALL" PATENT REFINING  
ENGINE, with separate adjustment to cones and discs,  
and our Patent Ball Thrust Bearing.

---

**APPLY FOR PRICES.**

---



OTTO WANDEL  
President

HERBERT H. MILLER  
Treasurer

# Wandel Screen Manufacturing Co.

WALPOLE, MASS., U.S.A.

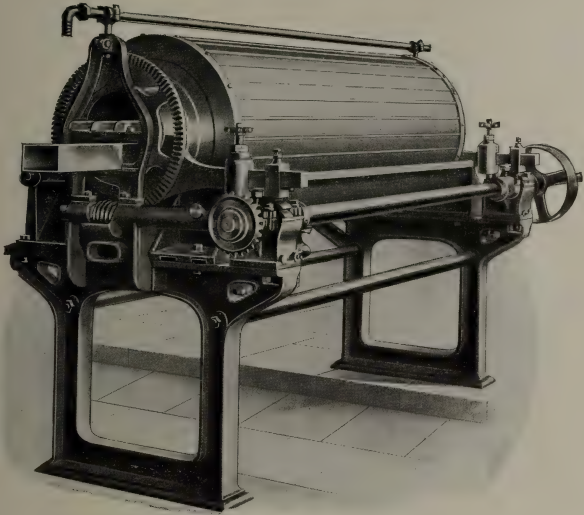

MANUFACTURERS OF THE

Quick Delivery.  
Write for Catalogue  
and list of users.  
We have no author-  
ized Agents in  
Canada.

# WANDEL ROTARY SCREEN

Over 200 Wandel  
Screens have  
been built and sold  
by us in the States  
within two years.

## SUPERIOR CONSTRUCTION

# J. M. VOITH

*Engineering Works and Foundries*

HEIDENHEIM °/Brz. (Wurt.)

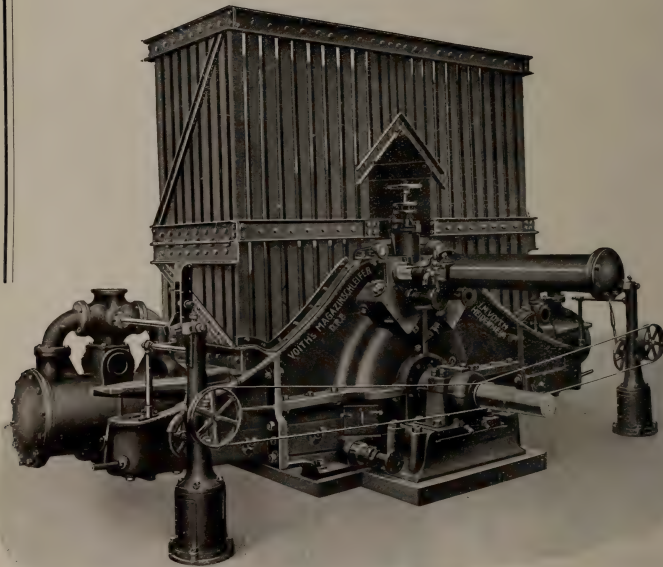

## VOITH'S MAGAZINE GRINDER

Patented in all principal countries.

Automatic Feeding and Reversing of Presses. 1 Grinder consumes up to 1000 H.P. Of more than 50 apparatus ordered, 25 already delivered and working most satisfactorily.

SPECIALITIES:

COMPLETE MACHINERY FOR  
WOOD PULP, PAPER  
AND SULPHITE **MILLS**

The Improved **“RUTH”** Centrifugal Screen  
Used in most prominent mills in Canada and U.S.

PATENTED IN ALL PULP-MAKING COUNTRIES

**WARNING.**

Pulp and Paper Makers are cautioned to beware of the manufacture or use of Centrifugal Pulp Screens infringing Canadian patent No. 95843 of Oct. 31, 1905.

The Ruth Centrifugal Screen is the only authorized Centrifugal Pulp Screen manufactured under said patent.

Infringers on said patent will be vigorously prosecuted.



**P. P. WESTBYE, M. E.**  
MANUFACTURER AND AGENT

**Pulp and Paper  
Mill Machinery.**

License Under Lease  
from the Patentee

**PETERBOROUGH, CANADA**



**MOVABLE CRANE  
PULP LOG  
STORAGE SYSTEM  
AND UNLOADER**

---

---

**The M. Garland Company**

BAY CITY, MICHIGAN

**Inventors of the Cable Conveyer**

# Have You Heard the Facts About The Beloit Machines?

---

---

One Fourdrinier built for 500 feet has run 615 feet, and averages 550 feet and makes 72,000 lbs. of print in 23 hours, 110 inch trim.

Another, built for 350 feet, for manillas, is running 490 feet every day on print.

Two others, built for 250 feet on book, are now speeded up to 340 feet on book.

A cylinder machine built for 40 tons of strawboard has made 89 tons in 23 hours, and averages 76 tons per day, dryers are 116 inch face.

---

---

## Beloit Iron Works

BELOIT, WIS., U.S.A.



# DILLON MACHINE CO

BUILDERS OF

## PAPER MILL MACHINERY

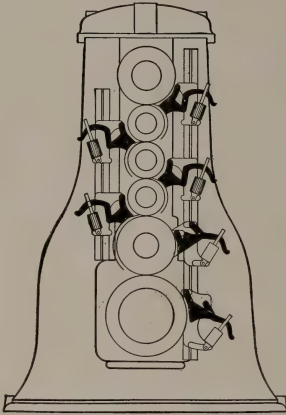

DILLON DOCTORS  
AND  
FEEDS

DILLON MACHINE CO.  
LAWRENCE MASS.

Beating Engines  
Washing Engines  
Jordan's Three Sizes—  
Single, Double & Triple  
Stuff Pumps, with  
Dillon Patent Valve  
Seating

Brannan Patent Paper  
Folders

Horizontal and Vertical  
Stuff Chests

Single and Double Paper  
Cutters

Backstands

Plates, Knives and Bars

DILLON  
PATENT  
DOCTORS  
AND FEEDS  
MADE IN  
CANADA  
BY THE  
SHERBROOKE  
IRON WORKS,  
SHERBROOKE, P.Q.

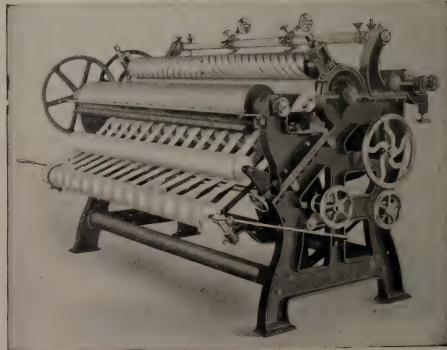

LAWRENCE MASS., U.S.A.

---

---

# THE MOORE & WHITE CO.

PHILADELPHIA, PENN., U.S.A.

SEND FOR BULLETIN.

**V**ERY severe tests have been made of this winder, but all of them have exceeded expectations. The photograph shows the winder attached to our standard slitter part which takes up less room than any other slitter and has several very good features. The winder can be used as a rewinder by attaching a back stand to carry the roll which is to be rewound.

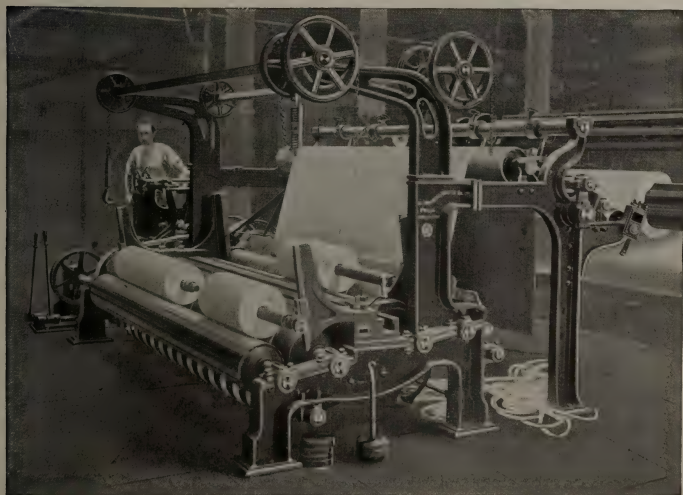

“M & W” Patented Four Drum Winder in operation.

**SATURATING, COATING AND WATERPROOFING  
MACHINERY**

**SPEED CHANGES**

**FRICTION CLUTCHES**

---

---

# HOLYOKE MACHINE COMPANY

HOLYOKE, MASS., U.S.A.

MANUFACTURERS OF

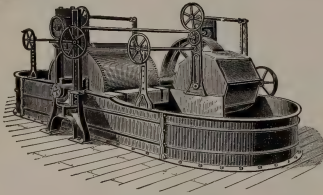

Washing and Beating Engines with  
Patent Double Hoist and Tubs of either  
wood or iron.

Hydraulic Pumps and Presses.

Rag Cutters and Rag Dusters.



Cotton and Paper Rolls with Patent Fastenings.

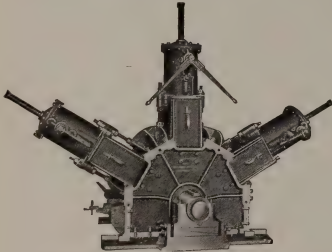

Patent Improved Wood Pulp Grinder.

Elevators, Rotary Fire Pumps and  
Friction Gearing.

Gears Accurately Spaced and Planed.

Shafting, Pulleys and Mill Work.

Machinery for Wood Pulp and  
Paper Mills.

Vertical and Horizontal Water  
Wheels with Flumes and  
all connections.

Wood Barkers, Wood Chippers  
and Wet Machines.

## Newest Designs

AND

## Highest Efficiency

Calenders. All kinds of Super-  
Calenders, Friction Calenders  
and Platers.

Chilled Iron Rolls.

Special Machinery

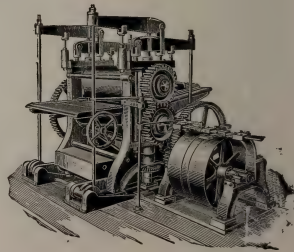

Description and Estimates Furnished; also Gear List  
and Catalogs sent on application.



# Pulp Wood Barker Bache Wiig Patent

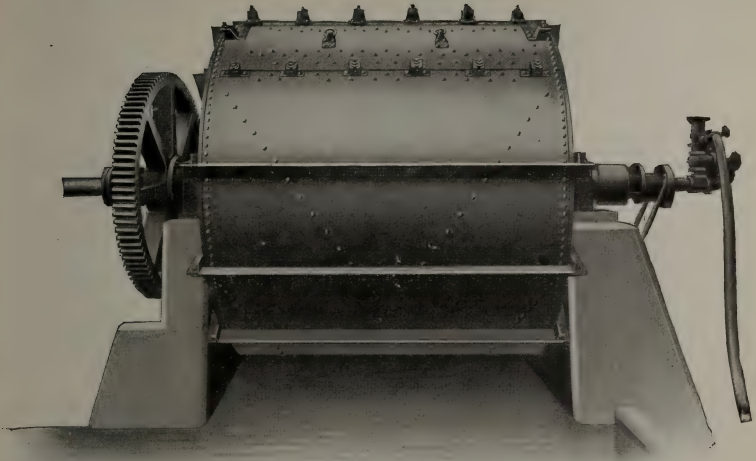

## THE LOSS WITH BARKING DRUM

Round wood covered with bark	-	-	-	8%
Slabs	-	-	-	23.8%
Edgings	-	-	-	9.4%

## LOSS WITH KNIFE BARKER.

Round wood covered with bark	-	-	-	22 to 24%
Slabs	-	-	-	50%

# The Jenckes Machine Co., Ltd.

General Offices: Sherbrooke, Que.

Factories: Sherbrooke, Que., St. Catharines, Ont.

Sales Offices: Sherbrooke      Montreal      St. Catharines  
Porcupine      Cobalt      Rossland      Vancouver

# JAMES BERTRAM & SON, LIMITED

LEITH WALK

EDINBURGH, - - SCOTLAND

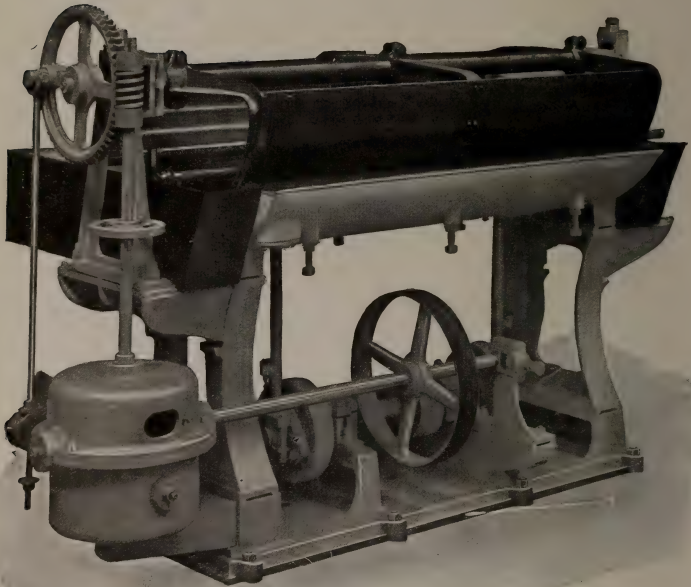

## “Whites” New Patent Strainer

With Oscillating Motion—Easily Cleaned.

Full Particulars on Application.

Telegrams—Bertram, Leith

---

---

# Battery Machines

(Save-Alls and Pulp Thickeners)



These pneumatic machines are operated in compact rows, by one blower, and by one line of shaft to each row. They have positively standardized the processes of thickening pulp and extracting stock from waste water.

Their operation is automatic, and is automatically maintained at the desired rate or density of output.

Their delivery is continuous, and the operation of the entire battery is in plain view, unobstructed by top gear or overhead connections.

No other class or make of pulp mill machinery affords the operative or the superintendent such a chance to keep his work up to the standard, without waste of time, power or stock.

---

SEND FOR FULL DESCRIPTION

---

**Sherbrooke Machinery Company**  
Limited

SHERBROOKE . . .

QUEBEC

TELEGRAMS } MILNE, EDINBURGH  
 CABLEGRAMS }

Code A B C 4th & 5th Editions'

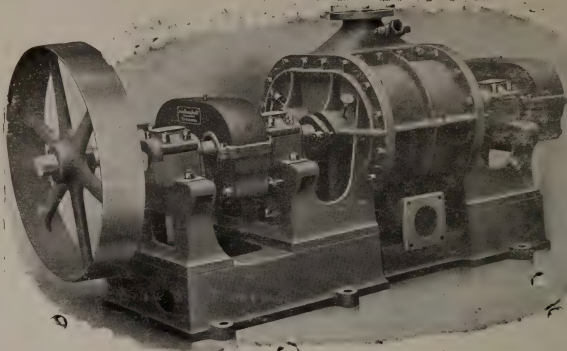

# HIGH DISPLACEMENT VACUUM PUMP

*(Made in Various Sizes)*

Suitable for

SUCTION ROLLS or VACUUM BOXES

MANUFACTURED BY

**JAMES MILNE & SON, LIMITED**

MILTON HOUSE WORKS, EDINBURGH

*DESIGNERS  
 AND  
 MANUFACTURERS  
 OF HIGH CLASS  
 PAPER MILL  
 MACHINERY*

*FAST RUNNING  
 PAPER MILL  
 MACHINERY  
 A SPECIALTY  
 LEAST VIBRATION  
 LEAST BREAKAGES*

*Don't Touch Your Mill Equipment Without Trying Milne.*

# Green Bay Barker

---

*Gösta Lerbachius*

*Postadress*

*Huusankoski*

*Telegrafadress*

*Lerbachius, Nymnensbruk*

*Huusankoski*  
*Finland*

May 9th, 1911.

Green Bay Barker Company,  
Green Bay, Wis.,  
U. S. A.

Gentlemen,

I beg to hand you herewith copy of letter received from the Aktiebolaget Kaukas Fabrik of Willmanstrand, Finland with regard to your barkers. In English this letter runs as follows:-

\*The American barking machine supplied by you has now been running  
\*for some time in our Sulphite Pulp Mill and the same has come up  
\*to our expectations in every way. Will you please enter our order  
\*for another barker, therefore, to be delivered during this summer  
\*if possible at the end of June or early in July.

The Aktiebolaget Kaukas Fabrik is the best known Sulphite Pulp Mill in Finland and known also on the American market for the high standard of its products.

Yours truly,

*Gösta Lerbachius*

Encl. -

*Reb.*

**WALM**

**High-speed Paper**

175 INCHES

**MAKING PAPER**

**600 FEET PAPER**

without Friction Clutch

**CHARLES WALM  
BURY, LA**

Estimates Given for Complete Paper-Making Plants.





# SLEY'S

## making Machines

WIDE ARE

ER AT OVER

ER MINUTE

nes or Gear Wheels

### SLEY & CO., LTD.

### NCASHIRE



Codes: McNeill's (1908 Edition) Western Union, Bedford  
McNeill's A. B. C. 5th Edition

# Wilson-Paterson Co'y



127 BOARD OF TRADE BLDG., MONTREAL.

Agents for the United Alkali Co. of England

## **OFFER TO THE TRADE:**

Caustic Soda 60° to 78° Soda Ash, Caustic Potash, Sal Soda, Silicate of Soda, China Clay, Rosin size and a full line of Rosins, direct shipment from the south.

**Contracts made for regular supplies.**

# PARSONS TRADING COMPANY

EXPORTERS OF PAPER TO ALL PARTS OF THE WORLD

20 VESEY STREET, NEW YORK

BRANCH OFFICES AT

LONDON

SYDNEY

MELBOURNE

WELLINGTON

CAPE TOWN

BOMBAY

HAVANA

MEXICO, D.F.

BUENOS AIRES

**CORRESPONDENCE WITH MILLS SOLICITED**

# THE CARTHAGE CHIPPER

WILL INCREASE YOUR CHIPS. WILL  
DECREASE YOUR SAWDUST. By virtue  
of its Design and its Patent Feed Spout it takes a  
MINIMUM AMOUNT OF POWER.

---

Ask Anglo-Newfoundland Development Co.  
Ask Laurentide Pulp and Paper Company.  
Ask The Riordon Paper Company, Limited.

---

OR WRITE

**CARTHAGE MACHINE CO.**  
**CARTHAGE, N.Y.**



# Pulp and Paper Magazine of Canada

A Magazine devoted to the interests of Canadian Pulp  
and Paper Manufacturers and the Paper Trade.

SUBSCRIPTION PRICE: \$2.00 a year. Single Copies, 20 cents.

The Pulp and Paper Magazine is published on the second Tuesday of each month. Changes of advertisements should be in the Publishers' hands not later than the 1st of the month, and, where proofs are required, four days earlier. Cuts should be sent by mail, not by express.

PUBLISHERS:

BIGGAR-WILSON, LIMITED,

Confederation Life Building, Toronto, Canada

## Postal Rates on Periodicals containing Samples of Paper.

There is a certain point in the rates charged for transmission of Canadian periodicals which discriminates not only against the journals themselves but against Canadian manufacturers of paper, printing ink, processes of illustrating and printing, etc. That is to say, some United States publications can be and are distributed by the Canadian postal authorities to Canadian readers at a smaller rate for postage than can be enjoyed by publishers of Canadian periodicals of the same class. This is unfair to the publishers of said Canadian papers, but it acts also against the interests of Canadian manufacturers of paper who, by being permitted to include samples of paper in their advertising would be enabled to reach many consumers of such paper, which under the present regulations they are unable to do. There can be no question of the efficacy of this means of advertising nor of the powerful handle the lower rate gives to competing American manufac-

turers of paper of the better grades. With the endeavor therefore to have this grievance rectified, the Pulp and Paper Magazine wrote the following letter to the Postmaster-General in Ottawa:

Toronto, Jan. 3, 1912.

Hon. L. P. Pelletier,

Postmaster-General,

Ottawa, Ont.

Honorable Sir: We beg to bring to your attention an anomaly in the postal regulations, whereby not only United States periodicals but United States manufacturers are placed at an advantage compared with their Canadian rivals.

At present such a paper as —, published at —, and containing samples of paper for printing and fine illustration work can be sent into this country at the rate of one cent. for four ounces, whereas under the Canadian postal laws if a Canadian publisher were to include such samples in his journal he would be

charged at the rate of 1 cent per two ounces.

We have no prejudice or grudge against the paper mentioned. On the contrary, we believe it to be an estimable, high-class publication. The only reason we feel prompted to take the liberty of drawing your attention to the matter is because present conditions discriminate against Canadian industry. It is not only that publishers of similar papers in this country are handicapped by having to pay double postage but that the advertising samples contained in the United States publications do much to take trade away from Canadian manufacturers of paper, printing ink, illustrating processes, etc.

Trusting that you will take this matter into early consideration, and that you may see your way clear to remove this disability under which both Canadian publishers and Canadian manufacturers suffer, we beg to remain,

Yours truly,  
BIGGAR-WILSON, Ltd.

To the above letter, the Postmaster-General, Hon. L. P. Pelletier, wrote a courteous reply, showing that he had given the matter consideration. He seems to have failed to grasp the point, however, that there was still a discrimination in favor of United States publishers of one half the postal rate charged to Canadian publishers of journals meeting the statutory requirements. His letter follows:

Ottawa, 5th January, 1912.

Dear Sir: I have received your letter of the 3rd instant inviting my attention to the —, and stating that although it contains samples of paper, etc., it comes

into Canada prepaid at the rate of one cent per 4 ounces, whereas Canadian publications containing similar enclosures would be liable to postage at the rate of one cent per two ounces or fraction thereof.

In reply, I would point out that copies of Canadian newspapers and periodicals recognized as such by the Department, are accepted for transmission by post to subscribers at the rate of one quarter of one cent per pound, whereas copies of the —, published monthly at —, can enter Canada from the United States by post only if prepaid by postage stamps at the rate of one cent per 4 ounces, or one cent per 2 ounces, according as the United States Post Office accepts the book as second-class matter, or at the sample rate. The rate of postage properly applicable to the —, when posted in the United States for Canada is a question for the consideration of the United States Postal administration, with whom the responsibility of classifying all mail matter posted in the United States rests, and under the convention between the two countries, Canada must accept such copies, provided they are prepaid by postage stamps at a rate of not less than one cent per 4 ounces, and deliver them without collecting any additional postage.

The Canada Post Office could not do otherwise than rule that the rate of postage on a publication published in Canada, similar in style to the —, would be the sample rate of one cent for each two ounces or fraction thereof.

The Post Office Act requires that a newspaper or periodical, to be entitled to statutory postal privileges, must be known and recognized as a newspaper

or periodical in the generally received sense of the word, and consist wholly or in great part, of political or other news or of articles relating thereto or to other current topics, whereas the — clearly fails to comply with the law in this respect.

Sincerely yours,

(Signed) LOUIS P. PELLETIER,

Postmaster-General.

To Biggar-Wilson, Ltd.,  
Publishers, Pulp and Paper  
Magazine, Toronto.

Upon receipt of the above, the Pulp and Paper Magazine wrote another letter as follows, to which, however, so far, we have not received a reply:—

Hon. Louis P. Pelletier,  
Postmaster-General,

Ottawa, Ont.

Toronto, Jan. 9, 1912.

Honorable Sir: We beg to acknowledge your favor of the 5th inst. and to thank you for the full consideration which you are giving to the matter to which we called your attention. We fully realize that copies of such a paper as our own may be sent to subscribers at the rate of  $\frac{1}{4}$  cent per pound, whereas the publishers of the — have to pay for transmission into Canada at the rate of 1 cent per four ounces. The point we wish to make, however, is that if we were to include in our magazine samples of paper, etc., such as is done in the case of the —, we would only be able to transmit the papers through the mails at the rate of 1 cent for two ounces, instead of 1 cent for four ounces, as in the case of the American journal mentioned. We, of course, fully realize that the Canadian Post Office has no privilege to

alter the postage rates on journals originating in the United States, and in fact we have no desire to have those rates altered. We do think, however, that in the interests, not only of Canadian publishers, but of Canadian manufacturers of paper, etc., as mentioned in our previous letter, that Canadian papers should be placed on at least an equal footing. Would it not be possible to make a departmental rule to the effect that Canadian publications which conform in all other respects to the statutory requirements should be permitted to include samples such as referred to in the case of the —, without being mulcted in extra postal charges?

Yours truly,

BIGGAR-WILSON, LTD.



**THE "FAVORED NATIONS" AND  
FOREIGN TRADE.**

Despatches from England report that, with the single exception of Sweden, the fourteen nations that have commercial treaties with Great Britain containing the favored nations clause, are not willing to release Canada from the operation of these treaties.

It will be remembered that at the Colonial and Imperial Conference in London last year, Sir Wilfrid Laurier asked the British Government to negotiate for the abrogation of the favored nations treaties, so far as Canada is concerned. As the "favored nation" principle is that in a commercial agreement between two countries they pledge themselves not to give any third nation better trade terms than they give to each other, and as this is the only appeal possible for a free trade country for fair

treatment in trade, the wonder was that a Canadian premier, professing free trade principles, should have made such a request. It is a fact of history that Great Britain, to please Canada, denounced the favored nations treaty with Germany, bringing on the tariff war between Canada and the German Empire, and although the act was only a measure of self-defence on the part of Canada, Great Britain has not to this day been able to arrange a new treaty with Germany. It is a question whether the Mother Country has not lost more trade with Germany since the abrogation of the treaty than she has gained with Canada through the British preference which caused the German-Canadian tariff war. Those who shout for the British preferential tariff, have yet to demonstrate whether they have helped or hurt British trade in its world-wide aspect.

But if reciprocity with the United States was advocated by Sir Wilfrid Laurier on the ground that it was an instalment of free trade, what was his purpose in seeking to deny these fourteen other nations that same measure of free trade, especially when, according to his own plea, the amount of competition with Canadian farm products would not amount to anything in the majority of cases? Neither Sir Wilfrid nor his colleagues on the platform or in the press, could ever give a straight answer to this straight question, and their silence on the point convicts them of the charge that their policy, if it had been carried out, would have sunk Canada into a subservient continentalism that would have excluded the country from its present prospects of foreign trade. More-

over, it would have wrought incalculable damage to British trade abroad if this example of narrowness and selfishness had been set by Britain's favorite daughter nation. It would have helped to knock away the last prop in Britain's commercial treaty system, and no wonder there was a general sigh of relief in the mother land when the news came that the reciprocity fallacy was exploded.



#### FOREIGN COUNTRIES DENIED.

The requests of Germany, Norway, Sweden, Denmark and Austria-Hungary for the free admission of pulp and paper, so as to be on the same terms with Canada, which has given nothing in return for free entry for her products, have been turned down—temporarily at least—by the United States Government. That is to say, President Taft has shelved the question so far as his government is concerned, and referred it to the Customs Court. This action, which has been taken after a good deal of wrangling and discussion on the part of the newspaper publishers on the one hand and the paper manufacturers on the other, is generally regarded as having been dictated mainly by political motives, and it may be months before a final decision is given by the courts.

Naturally, developments are being watched with keen interest on this side of the line, though whatever happens Canada has such supreme facilities for the manufacture of pulp and paper that these industries are bound to grow rapidly in strength and importance. It will make a difference, however, which way the controversy is decided, whether on

the one hand, the free pulp and paper clause from Canada is abolished, or on the other hand, if other nations are put on the same basis also. And this is what will have to be decided by the Courts. In the end, however, it is difficult to see how the foreign countries named will allow the matter to rest with a court decision, that is, if that decision be against them. In the latter event, they are sure to make diplomatic representations to the United States Government, and if that fails, it is altogether likely that Germany, at least, will adopt retaliatory tariff measures which may seriously affect other American industries. It is the general belief, however, that President Taft's aim is to postpone a final reckoning until after the elections.



The Canadian Lumberman makes a good point in commenting on the fact that in the recent Forestry Department's report on the quantity of timber used in the manufacture of wood pulp no slabs or sawmill waste was included in the material from which pulp was reported to have been made. Undoubtedly, Canadian resources lose heavily by this lack of economy. During 1909 in the United States 6 per cent. of the total pulp wood consumption was from slabs and mill trimmings. If economy had been practised to the same extent in Canada during the year 1910, as much pulp might have been produced as from 36,000 cords of wood, and not one pulp log need have been cut. This would have made 20 per cent. more pulp than Nova Scotia produced in 1910. Looking at the subject from another viewpoint, observes our contemporary, the gain might have been

much greater. Over one-half of the 5,000,000,000 feet of lumber cut in 1910 passed through mills at centres of large population where the slab waste of one-half cord to every thousand feet of lumber might have been saved from the incinerators. One cord of pulp wood will produce at least one-half ton of pulp, so that 1,250,000 cords of slabs obtained would have produced at the lowest estimate 625,000 tons of pulp. This amount is 30 per cent. more than the total of 475,000 tons of pulp produced in Canada in 1910.



Figures of United States imports of paper from Canada during the ten months ending with October 31st last, are particularly interesting in view of the changed regulations affecting the import of those commodities which came into force last July. The import of newsprint from Canada totalled 44,994 tons valued at \$1,699,180, compared with 45,770 tons valued at \$1,673,500, and 16,154 tons valued at \$605,435 for the same periods of the two previous years. Contrary to what most people would imagine, there was, as seen above, a slight decline last year as compared with the year immediately preceding, though a large increase over 1909. However, it is probable that with the last two months of last year included, the showing would be much more in favor of the year just closed. Everybody recognizes, however, that the full competition of the Canadian paper manufacturers has not begun to make itself felt yet. With so many new mills being built in this country, and extensions of older mills, the imports into the United



States from Canada may be expected to be on an altogether different footing in size and importance within a year from now.



Chester W. Lyman, of the International Paper Co., attempts to minimize the dependence of the United States upon Canada as a source of paper making material. His deduction is that "if no Canadian wood whatever were imported it would not jeopardize either our paper industry or our forests, provided we were protected in our markets by a fair duty." Just here is where facts seem to be against him, for his argument for a fair duty does not seem to be finding favor for the moment with the powers that be at Washington. Moreover, his feeling of independence as regards Canadian wood, does not seem to be shared by the great majority of his manufacturing confreres in the United States. However, he makes some points in speaking of the comparative smallness of the requirements of spruce wood, taking the paper making industry as a whole, in view of the increasing use of hemlock, poplar, balsam, mill waste, etc., to say nothing of the percentage of rags, besides a large number of different woods that could be used in case of absolute necessity. Still, all said, the fact remains that Canada possesses the largest and cheapest stores of the wood most in favor, combined with the necessary waterpowers.



Considerable comment has been made upon a recent order of the United States Treasury Department to the effect that pulpwood and paper made from "Indian"

lands in Canada, are exempted from the action of the clause giving free entry into the United States for pulp and paper from Canada on which no extra charges are made, but must submit to the regular rate of duty imposed on Crown land products. This decision is understood to be the result of the finding by United States Customs officials of an old law passed by Canada ten or twelve years ago, forbidding the export of pulpwood when cut from Indian lands. As a matter of fact, however, this concession to United States paper manufacturers, if concession it can be called, is of but minor importance, nor is it of any political significance. There is very little "Indian" wood of commercial importance, and the amount shipped in the past has been only a negligible quantity. In fact, Indian lands may be not improperly classed under the category of crown lands in any case.



One of the worst features of the British Preferential Tariff is that under its cloak goods made in a foreign country can be fraudulently shipped into Canada, not only in competition with home manufacturers, but to no advantage to the British manufacturer for whose benefit it was inaugurated. In the textile trade this shipping of German and other goods to Canada by way of Great Britain, and under a British label, has for many years been practised to a very detrimental extent. And in the paper trade it is also done. The manufacturers of coated paper have now to meet considerable competition from Great Britain in any case under the preference, but when to this is added the fact that some

of the coated paper which comes into Canada by way of Great Britain really originated in Germany and was simply repacked in England to save one-third of the duty, it is adding insult to injury. It is to be hoped that the new government will give renewed consideration to this whole question of preferential duties, and if they are to be continued, will at least make more stringent regulations whereby the fraudulent inclusion of foreign products under a cheap tariff, will be done away with.



The invention of a new form of pulp grinder is reported from Germany, which unless the story be exaggerated, is apt to revolutionize the mechanical pulp making industry of the world. The most marked features of the machine are a magazine which will contain no less than 25 cords of pulpwood in 4-foot pieces, and the fact that a ton of pulp can be made with 43 horse-power. An arrangement of the steam causes it to seep upward in such a way as to get the wood in good condition for grinding. We understand that some of the new machines are already in operation in Sweden. It is difficult to understand how such a vast quantity of wood can be automatically turned into position for grinding, but hope to be able to give fuller particulars at an early date.



We are glad to learn that Captain R. R. Barber, son of Mr. J. R. Barber, the veteran paper-maker, and business manager of the Georgetown, Ont., Paper Mills, is now recovered from his recent attack of pneumonia.

### WOOD REQUIRED TO MAKE ONE TON OF PAPER.

Hardy S. Ferguson, New York, gives the following estimate of the amount of wood required to make one ton of newspaper:—

(1) One cord of wood will yield 1 ton dry ground wood pulp. (2) Two cords of wood will yield 1 ton dry sulphite pulp. (3) In the paper mill 22 per cent. of the sulphite is wasted. (4) In the paper mill 8 per cent. of ground wood is wasted. (a) Paper containing 25 per cent. sulphite. One ton paper requires— $25/98 \times 2 + 79/92 \times 1 = 1.32$  cords. (b) Paper containing 22½ per cent. sulphite. One ton paper requires— $22.5/98 \times 2 + 77.5/98 \times 1 = 1.30$  cords. (c) Paper containing 20 per cent. sulphate. One ton paper requires— $20/98 \times 2 + 80/98 \times 1 = 1.28$  cords.



As recently mentioned, the E. B. Eddy Co., of Hull, Que., are making extensive additions to their paper mill and power plant. They have started the coffer dams preparatory to work on their hydro-electric plant on which they expect to expend \$500,000. When these new works are complete the company will have within its own control 12,500 horsepower to apply to its various industries. This installation is so planned that by means of conveyors the wood will be dropped into the grinders instead of being dragged up to them. New "slush tanks," the largest of which will be 80 ft. wide and 80 ft. long, will be provided for the more direct transfer of the pulp, the handling on the wet machine being saved, and a 1,500 lb. beater can thus be filled in four minutes. In the new mill there will be twelve new grinders of 400 horse-power each operated in sets, there being three grinders to a set. The pulp mill building will be of concrete and steel 180 by 130. The walls are now being built and the roof is to be finished in the spring.

## Pulp and Paper News

The third annual meeting of the Canadian Commission of Conservation is taking place in Ottawa this week.

\* \* \*

The Metabechouan Co. is erecting a 50-ton pulp mill at St. André de l'Épouvante, Lake St. John district, Que.

\* \* \*

J. E. A. Dubuc, managing director of the Chicoutimi Pulp Co., has donated \$90,000 to the Seminary of Chicoutimi, Que.

\* \* \*

A project is on foot to erect a pulp and newsprint mill in the vicinity of Lake Winnipeg. Plans will not be matured for some time yet.

\* \* \*

The friends of Mr. Booth, paper manufacturer, of Ottawa, will be sorry to hear that he is still confined to his house as the result of his recent attack of sciatica.

\* \* \*

The Grenville Board and Pulp Co., Thorold, manufacturers of plaster board, etc., have been granted by the town a fixed assessment of \$4,000 for a term of ten years.

\* \* \*

Ontario and Minnesota Power Co. are applying for an injunction to restrain Rat Portage Lumber Co. from holding back the waters of Rainy River by means of dams, etc.

\* \* \*

The assessment on the saw and pulp mills of Jas. MacLaren Co., Buckingham, Que., has now been fixed at \$100,000, instead of \$60,000, at which figure it has been for several years.

\* \* \*

The Roberval Paper Co., Ltd., recently incorporated in Montreal, with capital of \$3,000,000, has been granted by the municipality of Roberval, Que., a bonus of \$10,000, with exemption from taxes for 15 years.

Rebecca A. Davy, of Niagara Falls, daughter of James Davy, owner of one of Thorold's pulp mills, died recently, leaving considerable property to her father, as well as other persons, and to some institutions.

\* \* \*

The International Land and Lumber Co., Ltd., Ottawa, have purchased A. B. Hunt's large spruce limits in the Lake St. John district, Quebec, on which they plan to build a 125-ton newsprint mill, also ground wood and sulphate mills.

\* \* \*

The Commercial Box and Envelope Co., Ltd., of Canada, is putting up a factory in Kingston, having been granted certain concessions by the city. This is a branch of an American company of Binghamton, N.Y., of which B. B. McFadden is head.

\* \* \*

Barber Ellis, Ltd., Toronto, alluding to the paragraph in our last issue respecting their plans for Brantford, inform us that they expect in their new factory to have a capacity of 2½ millions and an output of two million envelopes per day.

\* \* \*

Among the New Year's honors granted by His Majesty King George, was a Knighthood to Rodolphe Forget of Montreal, who is interested in the East Canada Pulp and Paper Co., Wayagamack Pulp and Paper Co., etc. He celebrated his 50th birthday last month.

\* \* \*

The Colonial Wood Products Co., Thorold, Ont., has plans prepared to bring its capacity up to 80 tons per day. It is now about half of that. There will be eight grinders on four wet machines, all run by electric power, which will be extended, as will also the present building.

H. W. Schofield, secretary-treasurer of the Edward Partington Pulp and Paper Co., St. John, N.B., arrived back from England on the "Empress of Britain" just before Christmas. Plans for the new mill at Union Point are not completed, though much satisfaction is felt at the successful boring of the new wells on the property.

\* \* \*

Mr. R. O. Swezey, of Kimball and Swezey, pulp mill and forestry engineers, Quebec, reports great activity in the construction of works for water storage as well as in forestry work throughout the province of Quebec, and the present year is likely to show great developments in that province in the pulp and paper industry as well as in the lumber business.

\* \* \*

The S.S. "Whatakane" from Montreal, reached Australia recently with the largest shipment of Canadian paper ever made from Canada to Australia. Except agricultural implements, paper is Canada's largest export to the Commonwealth. In 1910, it amounted to over £158,000, compared with £111,000 from the United States and £303,500 from Great Britain.

\* \* \*

C. Nelson Gain, who for the past five years has filled the position of chemist for the Walloomsac and North Hcosick Mills of Stevens & Thompson, New York State, has been appointed chemist and assistant superintendent at the Kinleith Paper Mills, St. Catharines, where he had put in three years before leaving for the States. We are pleased to welcome Mr. Gain back to his native land.

\* \* \*

An indication of the growing demand for writing paper and envelopes needed for Canadian consumption is given in the report of the Canada Post Office for the year ending March 31st last. Over 553,000,000 letters and postcards were transmitted through the mails. The revenue obtained from postage matter was \$11,000,000, about \$1,000,000 increase over the previous year.

The Ontario and Minnesota Power Co. is applying for power to obtain sites for its proposed large industry at Fort Frances, Ont. E. W. Backus, the president, states that only by expropriation can he obtain the necessary land at a reasonable price. The pulp and paper mills will be on the same scale as at International Falls across the river and he states that a million dollars will probably be expended during the coming year.

\* \* \*

The Nova Scotia Power Co., in which John R. MacLeod, Frank Stanfield, F. B. Curdy, Hon. B. F. Pearson and Sir F. Borden are interested, will shortly issue \$500,000 worth of five per cent. mortgage bonds, with the intention, it is understood, of taking over several subsidiary companies, including the McLeod Pulp and Paper Co.; Halifax Tramways Co., etc. The pulp mill, which has been making good profits, will be doubled in capacity and a new beating engine and driers added.

\* \* \*

The annual meeting of the Victoria Paper & Twine Company, Ltd., of Toronto, Canada, was held in Toronto at the Prince George Hotel on 9th inst. The business of 1911 showed a very encouraging growth in every detail. The same directorate was again appointed and the outlook for 1912 is regarded as particularly bright. The company have been appointed selling agents for the Rogers' Paper Manufacturing Company, South Manchester, Conn., who manufacture a high grade "Press Board" for textile mills. Any enquiries for samples, etc., will be most promptly attended to.

\* \* \*

The Beaver Company of Buffalo are preparing to start the erection of their Canadian mill at Ottawa. This will be operated as a Canadian corporation under the name of the Beaver Board Company of Ontario, Ltd. The new mill is located just outside of Ottawa at a place to be known as Beaverville. The main building will be 70 x 450 ft.,

the power house 45 x 100 ft., and the office building 40 x 60 ft. The buildings will be started as soon as the frost is out of the ground and are to be finished about September. It will be operated by electricity. It will have one machine of 98 in. width trimming to 96 in., and its chief product will be mill board or plaster board and other board used for wall coverings, plain and decorative. W. F. McGlashan is president, and H. S. Lewis secretary. In the meantime the company is producing board for the Canadian trade, having a machine in operation in one of the Booth mills.

\* \* \*

The annual review number of The Monetary Times, Toronto, has been issued and makes a volume of 176 pages, the full size of the regular issue. The banking, bonds and securities, stocks, loans, insurance, manufacturing, natural resources and transportation, are treated by special writers, and a vast amount of information, statistical and general, is given, making the third annual number the largest and most comprehensive that has ever been presented by a Canadian financial journal.



### SOCIETY OF CELLULOSE AND PAPER CHEMISTS.

(Report Papier-Fabrikant.)

During the last half-year the number of members has had a satisfactory increase.

The discussion on processes of sizing paper was introduced by Professor Dr. Schwalbe. As this subject was discussed at the last general meeting there is not much to be added. At various places it has been attempted to start obtaining rosin. The result of these trials must be awaited. In Siberia casein is said to have been produced on a large scale. Also, the employment of starch has been proposed in a form which can be precipitated with alum. As an additional

substitute for rosin, perhaps so-called pine oil (Tallöl) comes into question, such as can be separated during the recovery of soda in soda-cellulose mills at a certain point during the evaporation. Further, we are reminded that the wood used for the manufacture of cellulose contains enormous quantities of rosin, and it should be considered whether it cannot be obtained for the purpose of sizing paper.

The question of valuing rosin has not yet progressed very far, the value of a rosin being at present principally determined by the color, the kind of fracture (generally a conchoidal fracture is preferred), and by the acid index. The speaker proposed as an additional important point the percentage of matter insoluble in petrol-ether. The color of the rosin and the rosin-size made therefrom appear to be connected with this amount. By preserving rosin in a powdered state the proportion insoluble in petrol-ether is materially increased, and may amount to 25 per cent. The part played by alum in rosin-sizing possibly consists, besides other functions, in the alumina acting as a protective envelope round the individual fine particles of rosin, and thus preventing oxidation, rendering impossible or postponing prejudicial influencing of the sizing. In valuing rosin the percentage of turpentine comes into question in addition. The original supposition that this acts as a catalytic agent (transferrer of oxygen) does not, however, appear to hold good. The melting point seems not to play an important part in the sizing process. When estimating rosin it was observed that by drying at 105 degs. the rosin is attacked considerably more severely than at 100 degs., and when the latter temperature is maintained a constant weight is obtained very much more quickly.

The action of the non-saponifiable portion in rosin has not yet been sufficiently investigated. This portion generally varies between 3 and 15 per cent. If this non-saponifiable portion is iso-

(Continued on Page 21.)



## Literary Notes.

### WATERPOWERS OF CANADA.

The Commission of Conservation, Ottawa, of which Hon. Clifford Sifton is chairman, and James White secretary, has now issued its valuable report on Canada's Waterpower Resources, to which we have referred before in these columns. It represents the first inventory ever taken of the waterpowers of the Dominion. The investigation shows that there are 1,016,521 horsepower developed from waterpower in Canada. Every phase of the subject from the laws governing the disposition of waterpowers in the various provinces, to the actual physical data regarding each individual waterpower concerning which information was obtainable, is treated. In addition, there is a very full bibliography of 30 pages, and appendices giving, among other things, the text of the laws concerning the export of power and also of the treaty recently concluded with the United States regarding the establishment of an International Joint Commission.

The volume opens with two chapters of an introductory nature that are concerned mainly with the general economic bearing of waterpowers on national development. The relation of water to agriculture, mining, navigation, domestic supply and so forth, is dealt with, and the principles to be used in the interpretation of waterpowers data are stated and discussed critically. The broad and optimistic statements very often made on the platform and in the press regarding our vast waterpower resources are deprecated.

A chapter is devoted to the waterpowers of each province in which the general features of the province as regards waterpower development are discussed, and an outline given of the law whereby powers are granted or leased to private individuals or corporations. The

larger developments are also described. The statistical data given in tabular form includes the height of the fall, the horsepower that may be developed, the present development and the main uses to which the power is applied, such as lighting, pulp and paper making, etc. Reference is also made to the possibility of increasing the amount of power developed by storage reservoirs and dams where such are feasible.

The power situation in Ontario is treated very fully, special attention being given to the power possibilities at Niagara and the conditions affecting development there. The report states that the low-water flow of the Niagara River would yield at the Falls, about 2,250,000 horsepower, of which Canada's share (one-half), would be 1,125,000 horsepower. Franchises have already been granted and plants partially completed, for the development on the Canadian side of the river, of about 450,000 horsepower. In other words, instead of "millions" of horsepower being available, as has been sometimes stated, it appears that about half, and by all odds the better half of Canada's usable share of Niagara Falls power has already been placed under private control.

The volume embodies all the useful information regarding the waterpowers of Canada that has heretofore been collected, and this has been supplemented and, in many cases, verified, by field surveys, conducted by the engineers of the Commission. In fact, all the information regarding the Maritime Provinces powers was obtained in this way last year by the experts of the Commission. A valuable supplement to the work is a series of maps showing the waterpowers in the various provinces and the irrigation canals in Alberta.

\* \* \*

The "Prosperity Number, 1911," of the "Commercial," published by the

Hugh C. MacLean Co., Ltd., Winnipeg, is a good-looking example of what it represents, namely, success. It contains about 175 pages in a striking cover, and contains not only a large number of articles and reports on the Commercial's usual subjects, but special articles on the growth of the Western Canada lumber industry, etc., etc. Our contemporary is to be congratulated.

  
**CALENDARS.**

The Pulp and Paper Magazine has received serviceable office calendars from the following firms: Rolland Paper Co., Ltd., manufacturers of bond and linen papers, Montreal; Wm. Barber & Bros., Ltd., paper mills, Georgetown, Ont.; Allis-Chalmers-Bullock, Ltd., engineering and electrical works, Montreal; Confederation Life Association, Toronto; The Manson Co., Thorold, Ont.

The Don Valley Paper Co. of Toronto have sent out a very serviceable souvenir in the form of a paper weight containing a calendar of the years till 1920, the reverse side containing a mirror. It is about 4-in. in diameter. For our readers' sake, we regret to report that the supply of these is exhausted.

  
**NEW PROCESS OF SODA  
RECOVERY.**

A process of soda recovery, invented by Dr. Rinman, as described in a Swedish paper, is expected to revolutionize the present method of manufacture of sulphate wood pulp, owing to the fact that the use of sulphate of soda will be discarded and the objectionable smell which attends the employment of that chemical will be avoided. It is this smell which has largely stood in the way of the development of the soda wood industry in certain districts.

According to the new process, the evaporation of the black lyes as at present performed, will be dispensed with, and the organic impurities extracted from the wood by the lyes will be precipitated by saturating the liquid with

carbonic acid gas. That portion of the proposal, however, is not new; it has not heretofore proved successful on account of the bulky gelatinous nature of the precipitate which presents insuperable difficulties in its filtration and the recovery of the purified lye. Rinman's new invention consists in adding a certain proportion of common salt to the caustic digestion liquor and the presence of this salt causes the subsequent separation of the organic precipitate with carbonic acid to take place quite easily by simple filtration.

The patents dealing with the ultimate details have not yet been published, some modification of the original patent having been found necessary in order to obtain complete purification of the black liquors, but it is stated that success is now assured.

The purified filtrate is recausticized with lime and is ready for re-use after the addition of sufficient alkali to make up the loss. The precipitate which has been filtered off from the purified lye contains the organic matters extracted from the wood; this precipitate serves for the manufacture of valuable by-products. It is dried and mixed with alkali or lime and then subjected to destructive distillation in such a manner that acetone, wood spirit, motor oils and decolorizing charcoal are obtained; the residue from the distillation is lixiviated and the soda which it contains is recovered.

It will be remembered that one of the main advantages of the sulphate of soda process over the plain caustic soda process for digesting wood lies in the fact that the sulphate of soda protects the fibre from the destructive action of the caustic during the period of digestion. Thus the sulphate process gave a higher yield and a stronger fibre than the plain caustic process. This advantage is not sacrificed in the new Skutskär process, since although the sulphate is discarded, and with it the smell nuisance disappears, the presence of the common salt in the digestion liquor performs a similar service as regards preserving the fibre and increasing the yield.

## USE OF NATIVE WOODS.

(By R. C. Lewis, Faculty of Forestry,  
Toronto University, in Sunday World.)

Next to the importance of buying goods "Made in Canada" comes the more complete utilization of Canada's natural resources. Our timber resources are wastefully utilized and we import large quantities of material from the United States and other countries that might just as well be "Grown in Canada."

Many of our native species are but little known and their lumber but little used. In many cases prejudice combines with ignorance and valuable timber is left to rot in the woods that might prove to be cheaper and better than wood now manufactured.

Many of our trees do not produce durable wood but much of this can be greatly improved by the use of preservatives. Prejudice has held that preserved lumber loses its strength and elasticity what it gains in durability. This has been proven to be untrue.

A strong prejudice exists against fire-killed timber, although it may be quite sound. It has been found that creosoting such wood improves its strength as well as its durability.

The United States Forest Service has established a laboratory at Madison, Wis., in connection with the University of Wisconsin, for the purpose of investigating just such important facts. Thousands of dollars have been spent in the past in gathering data and making experiments in the strength of structural timber, durability of building material, and the various preservation processes. Many varieties of timber have been considered useless in the past and the forest service has been the means of demonstrating their utility for certain kinds of work.

The results of these costly experiments and investigations are put into bulletin form and given to the world at large. The Canadian Forest Service in-

tends to take full advantage of this fact and profit by the experience of their American neighbors.

While the plans of the forestry branch at Ottawa are not yet fully defined, it is intended to follow the American idea inasmuch as it applies to Canadian conditions.

Demonstration plants for the preservative treatment of farm timbers; posts, rails, poles and barn and silo timber may succeed in showing the western farmer that the native poplar can be more fully utilized than in the past.

Similar plants along the railway belt in British Columbia will treat fire-killed Douglas fir, which is now going to waste in enormous quantities.

A small pulp mill at Ottawa will be used as a central point for demonstrating to pulp and paper manufacturers the fact that excellent paper can be made from balsam, jackpine and hemlock, both green and dead, and from sawmill refuse that now goes to the burners. Jackpine forms a large percentage of Canada's timber supply and it is at present considered almost useless. Probably one-third of the material brought to the mills on the west coast now goes as refuse to the waste burner.

The American investigators have proved that all such material can be used in the paper industry in the existing plants with slight changes in the digestive process. Swedish craft paper, one of the most valuable of the heavier wrapping papers, can be manufactured at a good profit from this material that is now going to waste.

The plan outlined for Canada includes a demonstrating plant for treating jackpine paving blocks and sample pavements will be laid in the larger cities to show the public the utility of this much despised timber.

Apart from treating inferior woods an effort will be made to show manufacturers the value of some of our native hardwoods and better classes of conifers. Douglas fir is little known in the east for interior decoration and floor-

ing. It is a very hard durable wood with a beautiful grain when properly sawn and finished. Birch, maple and poplar are superior in many instances to the red gums and tulip woods imported in such large quantities from the States.

The enemies of forest conservation says that wood is being substituted by other materials such as concrete, steel, etc., to such an extent that forestry is not economical. On an average this substitution has not amounted to more than five per cent. in the last ten years.

A few examples of inferior woods that can be substituted for more expensive ones already in use are here given.

Western hemlock is almost equal to eastern white pine and is much superior to eastern hemlock. Its name has prejudiced the public against its use.

Alpine fir and Englemann spruce and lodge pole pine make quite serviceable telephone poles where eastern cedar is becoming prohibitive in price. They can also be substituted for Douglas fir for mine props and logging.

Creosoting western yellow pine and fir does not affect its strength or elasticity. Western white pine and yellow cedar make excellent second-grade pencil stock to replace the imported pencil cedar.

The chief object of this new branch of forestry will be to interest manufacturers in the more complete utilization of our native woods to cheapen the cost of manufacture and provide a market for the products of our Canadian-managed forests of the future.



#### LOADING-MATERIAL IN PAPER.

In an article in *Papier Fabrikant*, J. Vestergren says:—Loading-materials are added to paper in order not only to improve the appearance of the paper and to render it more suitable for being written and printed on, but also to diminish its transparency and the cost of manufacture. The following loading-materials come into consideration:—

Kaolin, china clay, alumina...Aluminium silicate.  
Gypsum, Terra Alba, annaline....Nat. calcium sulphate.  
Pearl hardening, crown filler.....Artif. calcium sulphate.  
Satinite....Artificial product made by precipitating alum with slaked lime.  
Baryta...Nat. barium sulphate.  
Blanc fixe...Artif. barium sulphate.  
Asbestine agalite, talc.....Principally magnesium silicate.

Heretofore, when buying loading materials, only their percentage of water, besides their color and fineness (grinding, elutriation) have been considered. The percentage of water is determined by drying at 100—110° C. In order to judge of whiteness the test is reduced to mud in water or, according to Klemm, in glycerine, and compared with a standard treated in the same manner. Kaolin tinted with ultramarine and tar colors shows, when spotted with turpentine, a blue color. For judging of the fineness, the speed with which a test reduced to mud settles again, is observed. The greater the fineness, the longer the test remains in suspension. The quantity of coarse sand is determined by reducing the loading-material to mud and washing out the finer particles or by sifting it with the aid of fine silk gauze. Belani found 0.1—0.4 per cent. coarse sand and mica in good English and Bohemian alumina by reducing them to mud and washing out the finer particles. Winkler strains the test reduced to mud through silk gauze, having 3,600 meshes per square centimetre, and did not obtain more than 0.33 per cent. residue on the strainer from good loading-materials. W. Schacht considers a loading-material still suitable for better qualities of writing and printing papers when not more than 2 per cent. residue remains on the strainer of the above fineness. Generally, however, the quantity of coarse sand is estimated according to the space which it occupies when it settles in the

mud cylinder or by its fell when rubbed in a mortar. Loading-materials are tested chemically as follows:—

Alumina. With regard to iron, lime.  
Talc. With regard to iron, lime, gypsum.  
Agalite. With regard to gypsum lime.  
Gypsum. With regard to chalk, calcium sulphide, alkali.  
Blanc fixe. With regard to acidity, alkalinity.  
Satinite. With regard to alkalinity.

These investigations do not, however, give the desired information as to the real value of the material as loading-material for paper. Also, these determinations generally supply too indefinite results in order to serve as standards when buying. On the contrary, it is more important to know:

- (1) How the loading-material behaves during the manufacturing process;
- (2) What properties the same can lend to the paper;
- (3) What yield can be counted on.



### NEW INCORPORATIONS.

The Southam Press, Ltd., Hamilton, Ont., capital \$1,000,000. To publish newspapers. W. Southam & Sons.

Ontario Pulp and Paper Co., Toronto, capital \$3,000,000. To manufacture and deal in pulp and paper, etc. J. W. Bain, F. R. MacKelcan, of Toronto, and other barristers and clerks, are the names mentioned.

Jerome H. Remick & Co., incorporated under New York State laws, is authorized to carry on business in Ontario as music publishers, with a capital not exceeding \$40,000. J. F. Edgar, barrister, Toronto, is the company's attorney.

The Beaver Company, Ltd., Ottawa, capital \$500,000. To manufacture and deal in pulpwood, wood pulp, paper, wall boards, sheeting and roofing papers, wrapping paper, bags, tissues,

wax papers, tags and paper specialties. The names mentioned are T. Wallace Lawson, barrister, and some law clerks, etc., all of Toronto.

The Frederickson Co., incorporated under Illinois laws, licensed in Ontario, to do business as manufacturing stationers, printers, publishers, manufacturers of envelopes, etc. Capital \$40,000. F. E. Brown, Attorney, Toronto.

### British Columbia Companies.

Higgins, Fisher & Co., Ltd., Eburne, capital \$100,000. To operate saw, pulp and paper mills.

Americana Co., Ltd., Vancouver, capital \$10,000. To print and publish magazines, etc.

The Bowman Investment Co., Ltd., Victoria, capital \$25,000. Timber merchants and proprietors of saw and pulp mills.

E. T. Kingsley, Ltd., Vancouver, capital \$50,000. To do business as printers and publishers of newspapers, journals, magazines, books, dealers in stationery, etc.

Hazelton and Skeena Valley Land Co., Ltd., Vancouver, capital \$100,000. To act as timber merchants, own saw and pulp mills, etc.

Canada Post Publishing Co., Ltd., 319 Broadway East, Vancouver, capital \$15,000. To acquire the "Canada Post" and publish and circulate newspapers, magazines, etc.

Scientific American Compiling Department, Ltd., Vancouver, capital \$10,000. To enter into agreement with A. E. Garrett, incorporated under New Jersey laws, and print and publish books, magazines and newspapers, etc.

Barnhart Brothers & Spindler, incorporated under New Jersey laws, with capital of \$3,000,000, to do business in British Columbia; head office 719 Pender St. West, Vancouver, J. P. Geddes in charge. To manufacture and deal in printer's materials, paper, ink, etc.



## Recovery of Black Liquor in Sulphate and Soda Pulp Mills.

The question of soda recovery in a soda pulp mill is of paramount importance and on the economical working of this department the whole mill is dependent. This is due to the fact that the consumption of coal and soda form the heaviest items of working cost in the pulp mill, and if a correct arrangement is made, very large savings can be effected.

Most engineers have experienced the troubles of the soda recovery department and spent weary hours in their solution, and we think, therefore, that the figures given below will be of some interest, showing, as they do, how profits may be materially increased by adopting a properly arranged system of evaporation.

In sulphate pulp mills indirect evaporation has usually proved to be unsatisfactory, owing to incrustations from the wood adhering to the pipes and the latter becoming corroded in a short time. In most sulphate pulp mills, therefore, the liquor is evaporated by direct heat from the soda-melting furnace in rotating furnaces and evaporators.

During recent years, however, a new system of evaporation, designed by Mr. Karl Hellner, has come into use in Scandinavia. This system has been found by actual experience to do away with corrosion, and inspection has shown the entire absence of incrustation on the tubes where it has been adopted. These good results will no doubt bring indirect evaporation into use again seeing that a large economy in fuel can be effected by the system, which although somewhat expensive from the point of view of initial cost, usually pays for itself within the first two years.

The following calculations will give some idea of the amount of fuel which can be saved.

It should be stated that owing to the fact that no two pulp mills are working under exactly similar conditions, it is impossible to give general figures applicable to all cases, and the following supposition has been made in this article with regard to the black liquor. In the following the metrical system is used as it gives very short formulae and short reckonings. The metrical units are as follows:—

For weight: 1 kg.

“ heat : 1 centigrade (1°C).

“ quantity of heat: 1 calori (cal.)—  
the heat required for increasing  
the temperature of 1 kg. water  
1°C.

The liquor leaves the digesters, or the pulp washing apparatus, at a density of 95°B at 65°C (i.e. 12°B at 15°C) and is evaporated to 29°B at 60°C (i.e. 32°B at 15°C) before entering the rotating furnace. Of this liquor, about 12 Kg. are obtained per Kg. of pulp, 8.5 Kg. of which is evaporated, while 3.5 Kg. runs out to the rotating furnaces. These figures have been chosen as showing the general conditions when wet refuse from sawmills is boiled, but in cases where only dry wood is boiled the liquor obtained is thicker and a lesser quantity of water has to be evaporated. In this case an adjustment of the figures would have to be made, but for the purpose of this article it will be unnecessary to deal with liquor of more than one kind.

Fig. 1 gives some idea of how a multiple stage evaporator works. This is shown in diagrammatic form and the actual appearance is, of course, entirely different—the pipes, for example, in the apparatus itself, being straight and not spiralled, as shown in the diagram.

The evaporator may be assumed to consist of stages, the steam from the last stage being led to a condenser. The hot condensate water is taken to the liquid heaters, which can be assumed to heat the liquor to 80°C. This temperature is easily obtainable, and provided that heaters of sufficient size are installed, temperature of 100°C. or even higher, can be reached.

The steam for the evaporation is assumed to be dry and to have a pressure of 5 Kg. per cm<sup>2</sup> above atmospheric pressure (i.e. 6 Kg. per cm<sup>2</sup> absolute). Every Kg. of this steam delivers 500 cal. to the evaporator and returns to the boiler at a temperature of 158°C.

The specific heat of water is 1.0, the specific heat of the black soda may be taken to be 0.5, and further, the 12 Kg. of liquor may be assumed to contain 2 Kg. of black soda. The amount of steam consumed for evaporating black liquor corresponding to 1 Kg. of pulp may be taken as x Kg.

The most exact way to arrive at the amount of steam required to evaporate the liquor is to calculate every stage of the evaporator separately, but this involves a mass of figures out of all proportion to the importance of the exactitude of the result, seeing that considerable heat losses must occur which cannot be correctly estimated.

It is easier, therefore, to regard the whole evaporator as one single system, and consider the amount of heat carried to the system and the amount carried off.

**Heat carried to the evaporator per Kg. air dry pulp.**

Heat carried by the steam.... 500x cal.  
 Heat carried by the black liquor in the proportion of 10 Kg. water to 2 Kg. black soda, 10 x 80 x 1 x 2 x 80 x 0.5 = ..... 880 cal.

**Heat taken from the evaporator per Kg. air dry pulp.**

Heat carried by the condensate water from n-1 stages, the water having an

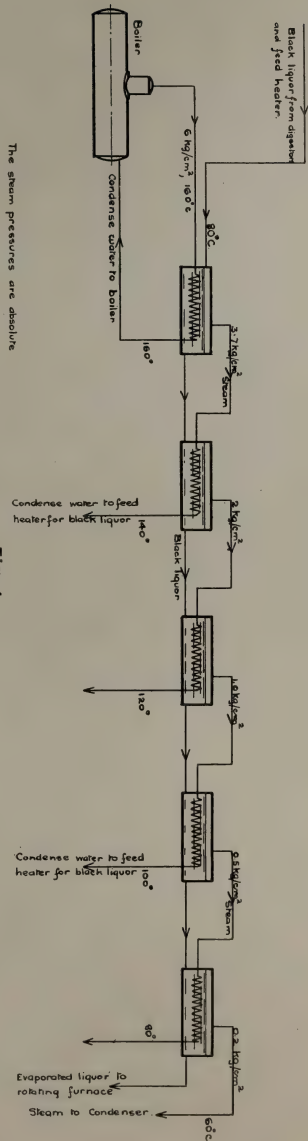

FIG. 1.

average temperature of 100°C., 8.5 Kg. of steam is evaporated.

$$\frac{n-1 \times 8.5 \times 100}{n} = \frac{850 + 850}{n} \text{ cal.}$$

Heat carried by the steam from the last stage to the condenser.

$$\frac{8.5 \times 622}{n} = \frac{5290}{n} \text{ cal.}$$

Heat carried by the black liquor

$$1.5 \times 60 \times 2 \times 60 \times 0.5 = 150 \text{ cal.}$$

The heat carried to the apparatus being equal to the heat taken from it, the following equation is obtained:

The figures for evaporators with various numbers of stages are given in the diagram (Fig. II).

The following calculation shows the importance of heating the liquor before it enters the evaporators. Instead of liquor of 80°C., liquor of 40°C. is assumed.

Thus:—

$$\begin{aligned} 500 \times 440 &= n-1 \times 850 & 5290 & 150 \\ & n & n & \\ x &= 1.12 & 8.88 & \\ & n & & \end{aligned}$$

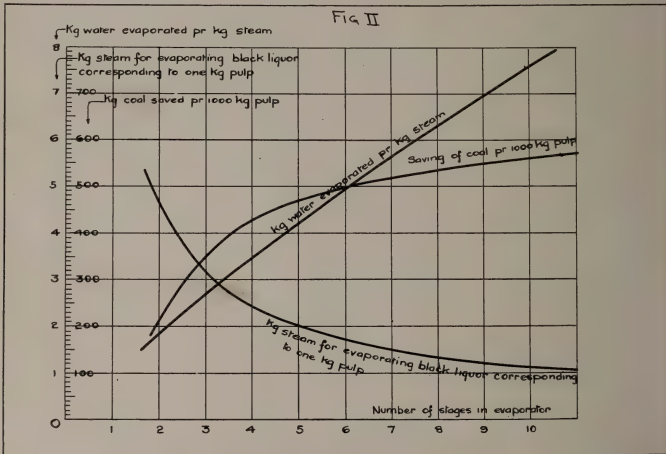

$$\begin{aligned} 500 \times 880 &= 850 & 5290 & \\ & n & n & \\ \therefore x &= 0.24 \times 8.88 & & \\ & n & & \end{aligned}$$

Kg.

The amount of water evaporated by 1 Kg. of steam is 8.5 Kg. For example,

$$\frac{1}{x}$$

in the case of a quadruple evaporator where n=4

x=2.46 Kg. steam per Kg. pulp and the amount of water evaporated by 1 Kg. of steam is 3.45 Kg.

which shows that the saving obtained by heating the liquor by means of the condensate water is 1.12 - 0.24 = 0.88 Kg. steam per Kg. pulp.

It will now be possible to work out the saving effected by the use of indirect evaporation compared with that obtained by direct evaporation and for this purpose coal is assumed as giving 7,000 cal. per Kg. The boiler efficiency is taken to be 65 per cent., a figure well on the safe side.

The direct evaporator gives a very good efficiency, seeing that the flue gases leave the evaporator with as low

a temperature as 100°C. to 120°C., and therefore 90 per cent. may be assumed. Further, the heating of the liquor before it enters the direct evaporators has been left out of consideration, in order to keep the figures on the low side.

The liquor in the evaporator has a temperature of about 80°C. and therefore the number of calories expended in evaporating 1 Kg. of water at atmospheric pressure is:

$$20\ 540 = 560\ \text{cal.}$$

The number of cal. required therefore for evaporating 8.5 Kg. of water—with 90 per cent. efficiency—is:

$$8.5 \times 560 = 5290\ \text{cal.}$$

---

0.9

This corresponds to:

5290

— = 0.75 Kg. of coal.

7000

For evaporating the liquor in a four stage evaporator 2.46 Kg. steam is to be used per Kg. pulp and the coal consumption for evaporating the liquor corresponding to 1 Kg. air dry pulp will, therefore, be:

$$2.46 \times 500$$

$$\frac{\quad}{7000} = 0.27\ \text{Kg.}$$

$$7000 \times 0.65$$

It has been shown therefore that the saving amounts to  $0.75 - 0.27 = 0.48$  Kg. coal per Kg. of air dry pulp.

The diagram (Fig. II) shows the saving effected by the use of evaporators with various numbers of stages and 10 per cent. has been deducted to cover losses by heat radiation, leaking of steam, etc. The figures obtained therefore may be considered as being on the safe side. It may be mentioned that where thinner liquor is used the saving is correspondingly larger and vice versa.

With regard to the most economical number of stages, reference should be made to Fig. 11, from which it will be seen that the greatest economy can be effected where from 3 to 5 stages are chosen. If a larger number are used the

saving will not be found to correspond with the increased cost.

When the indirect evaporation is introduced in a pulp mill a surplus of black soda is obtained at the melting furnaces and this black soda is used for firing under the boilers.

When the soda pulp mill is steam driven the use of indirect evaporation is especially advantageous. The evaporators in this case should be constructed in three stages, and the high pressure evaporator can then be heated by exhaust steam from the main steam engine, which may also deliver exhaust steam to the drying machine. The evaporators required 3.2 Kgs. steam per Kg. of pulp. (See Fig. II), but to be on the safe side, even where somewhat dry liquor is to be dealt with, 2.0 Kg. steam per Kg. pulp can be assumed. The drying machine requires about 1.9 Kg. of steam per Kg. pulp, and therefore, the total consumption of low pressure steam is approximately 4.0 Kg. per ton of pulp.

In the case of a pulp mill producing, say 30 tons per day,  $4.0 \times 30 = 120$  tons of steam per 24 hours is required, of 5,000 Kg. per hour.

In a modern steam engine, supplied with steam at a pressure of 12 Kg. per  $\text{cm}^2$  and at a temperature of 300°C., working with a back pressure of 0.6 Kg. per  $\text{cm}^2$  above the atmospheric pressure, a steam consumption not exceeding 9.10 Kg. (20-22 lbs.) per B.H.P. hour can easily be obtained, and the engine will, therefore, develop 500-550 horsepower, which is more than sufficient for driving the entire pulp mill.

As no steam has to be condensed, the thermal efficiency of the engine is nearly 100 per cent., the only losses being the heat radiation from the cylinders and the friction losses in the bearings and in the guides, the power will be exceedingly cheap and the coal consumption per horsepower thus developed may be taken, on the average, at one tenth per annum, to which must be added the cost of oil.

To the above should be added that the efficiency of the boiler plant is assumed to be very low (65 per cent.) and with a modern plant 75 or 80 per cent. should be received. The 90 per cent. efficiency which was assumed for the direct evaporation is rather a high figure, and therefore the saving in coal shown in Fig. II, will be available for soda pulp mills with soda departments equipped even with the best kinds of evaporators.

In conclusion, it may be mentioned the system of evaporators described above, and patented by Mr. Karl Hellner, are manufactured by the Karlstad Engineering Co., Sweden, and that the selling rights for Canada are held by the Canadian Boving Co., Ltd., of 164 Bay St., Toronto.



#### TRADE AND MANUFACTURERS' NOTES.

##### DODGE MFG. CO.

The Dodge Mfg. Co., Ltd., Toronto, send us copies of their two catalogues entitled, "Pulleys" and "Dodge Friction Clutch Mechanism." The company makes many designs of pulleys, but for ordinary service they supply a modern type of machine moulded pulley up to 48 by 18 metres in size. They say that where an all-metal pulley is desirable, the machine moulded split cast-iron pulley of modern design is undoubtedly the ideal pulley, the moulding machine permitting of a degree of accuracy and fine lines not obtainable by the old-fashioned process of floor moulding. Also this feature of accuracy extends further, especially in the direction of maintaining concentricity between the hub and rim, which feature is highly appreciated by mechanical men. Also, since their daily tonnage in pulleys is large, they are enabled to select and use certain mixtures of iron which are best adapted for pulley castings—iron that is strong, yet soft and easily machined and of low shrinkage properties, thus reducing internal

strain and possibilities of breakage to a minimum.

There is no question these days as to the good results to be obtained from friction clutches. "Dodge" clutches have been on the market for many years and during that period have been constantly improved, so that to-day they have a wonderfully high reputation. They are a split clutch of the disc type, which is probably the most efficient in use.

The two catalogues named give all particulars of both pulleys and clutches, together with detailed descriptions, illustrations and prices, etc.

The Dodge Mfg. Co. also publishes a brochure for the mechanical man erecting or extending factory or mill. This contains a number of good pointers on the value of thoroughness in equipment, etc.



##### VALLEY IRON WORKS CO.

The Valley Iron Works Co., of Appleton, Wis., has favored us with a unique story in the shape of a small, tastefully gotten up book entitled, "A Paper Man's Man," written by G. H. Paine. It should be explained that in this case the "Man" is E. A. Peterson. Mr. Peterson, of whom, by the way, a fine portrait forms the frontispiece of the book, is treasurer and manager of the Valley Iron Works, which under his guiding care have grown from a broken-down shop to the commanding position they now occupy. It was this company, we are told, which built and shipped the largest single lot of beating engines ever contracted for in the United States. Mr. Peterson originally come from Sweden, the land which has given birth to so many noted engineers. Not only is his career interestingly but concisely set forth, but the book is full of general interest to all paper manufacturers.



It is always refreshing, but particularly so at Christmas time, to hear of a concern sharing its success with its employees. The Parsons Trading Co., we



hear, made a Christmas distribution of half a month's salary to each of their employees in their ten offices in all parts of the world, thus setting an example of broad and generous dealing. Such a spirit is surely to be commended, and with the signal ability which has given them such a high position in the paper export world, they may well look forward to even greater prosperity.

\* \* \*

The Vera Chemical Co., North Milwaukee, Wis., who are probably the largest firm in the world specializing in size, are now shipping their size in tank-cans besides in barrels. The tank-cans are provided with heaters, so that the size may be heated when it arrives at its destination. This new departure in the handling of size is meeting with success, several United States paper mills now buying their size in that way.

\* \* \*

The Jeffrey Manufacturing Company, at their Canadian works, Montreal, have recently received orders for four rather extensive cable conveyors for the Lake Superior Pulp and Paper Co. at Sault Ste. Marie, Ontario, Canada; Geo. F. Hardy, mill architect and consulting engineer, is furnishing the designs and specifications. The East Canada Power and Pulp Co. have also recently ordered some Jeffrey equipments.



### SOCIETY OF CELLULOSE AND PAPER CHEMISTS.

(Continued from Page 10.)

lated and increasing quantities thereof are added to rosin size, the precipitate obtained with alum becomes constantly of larger flakes without however, any difference being noticed in the sizing.

In addition to the sizing processes being influenced by the kind and treatment of the rosins themselves they are materially influenced by the chemical behaviour of the fibres. Many kinds of

cellulose have the property of decomposing sulphate of alumina and absorbing the alumina. In this manner the above-mentioned function of the alumina hydrate providing the fine balls of rosin with a protective envelope is, perhaps, rendered difficult. This omission of the envelope, perhaps, also explains the frequently asserted diminution of the fastness of the sizing when employing free acid instead of alum. Also magnesium and sodium sulphate are clearly not able to undertake the functions of sulphate of alumina. Lastly, the proposals to decompose rosin size with CO<sub>2</sub> (Kollmann and Bräuner) or by the electric current are mentioned.

Dr. Klein mentioned that Erfurt pointed to the action of alumina as a protective envelope, and that when employing CO<sub>2</sub>, instead of alum an acid sizing is in question, and, therefore, its disadvantages are to be expected.

Dr. Wurster considered it possible to find a process of procuring rosin by which the rosin can be obtained from trees without the latter being injured, so that, perhaps, in countries where, having regard to the growth of the timber obtaining rosin has been refrained from, new sources of rosin could be opened up.

The chairman, Dr. Müller, reported that the attempts to obtain rosin from waste wood and the like have already yielded tangible results, and that samples of such rosin had been submitted to him.

(Continued in Next Issue.)



The Ontario Government will shortly make decision on tenders being received for supplies of paper for the province for the next five years.

The G.T.R. is putting in a new siding at the Northumberland Paper & Electric Co.'s mill at Campbellford, Ont.

## DOUBLING THE PRODUCTION OF PULP AND PAPER MILLS.

T. J. Stevenson, of the Kiordon Paper Co., had the following interesting article in the Financial Survey number of the Toronto Globe:—

"A nation's standard of culture may be gauged by the amount of paper it consumes per head," are the words of some commercially-minded person. If this be so, Canadians may pat themselves on the back for being the elite of America, because we consume more paper, individually, than does the citizen of United States, of Mexico, or of Central America. If this law be applied to the production rather than consumption of paper, Canada might elevate herself above the world as the great "high-brow" of the universe. We have been given every accessory for the manufacturing of paper, and our stock of materials is unlimited.

### Great Forest Wealth.

We, with our seven millions, produce from six to nine hundred tons of paper every day, and the most of it is used at home, while the United States, with its ninety millions, use about three thousand tons a day. Moreover, our chances for continuing in the good work of producing paper are infinitely better than those of our neighbors. Manufactures of forest products in Canada comprise the largest and most valuable portion of the country's industrial output. The wealth of forest land containing desirable pulp-producing woods, with their low percentages of resinous matter, especially desirable for the manufacture of paper, gives Canada a remarkable advantage as the future paper-producing region of the world.

### Advantages of Waterpower.

The many streams piercing the forests provide natural and economical means of conveying the logs to the mills for manufacture. Nature is also

kind to Canada in supplying the forest regions with deep snow of the Canadian winter, which the spring warmth converts into high water and freshets to drive the logs out of the many lakes and down stream to the waiting plants. An abundance of cheap power is at hand to operate these plants. The liberal rainfall of these regions is also a valuable assistance in this industry by maintaining high water levels in the streams for log-driving and power purposes throughout the open season. A year with light rainfall reduces the output of pulp and paper materially, particularly pulp, and 1911 has been comparatively dry over a large portion of the year.

### Electricity Being Used.

The application of electric power machinery to paper and pulp making has recently been greatly improved, and waterpowers which were not conveniently situated for mill sites can now be utilized by the use of transmission lines from the generating plant to the factory. At least two new enterprises of importance this year have been grinding mechanical wood pulp directly by electric power. The difficulty of uniting economy in wood supply and shipping facilities with moderate cost of power is thus overcome. Electric power will play a most important part in advancing the future of pulp and paper making in this country.

### A Difficult Industry.

With all these advantages it should not be assumed that the business of manufacturing pulp and paper can be successfully carried on by everyone desiring to enter the field. The early history of many mills which to-day are successful, the money lost in experiments, and bad management by others, and a few large plants still standing idle, show the necessity of a thorough knowledge of the business before risking the large sums necessary to embark in paper and pulp making enterprises. The production of pulpwood being much greater than our own country can at the

present time consume, renders it necessary to market the surplus quantity in the United States, Great Britain and her colonies. The marketing of Canadian pulp and paper is therefore governed by the price throughout the world, and Canada is called upon to meet all competitors abroad in this need.

#### **Cheap Production in Canada.**

Considerable importance was attached to newspaper and pulp in framing the reciprocity negotiations at Washington last winter. The United States Government Tariff Board made an elaborate report on the cost of manufacture in their own country and Canada, as a guide to Congress in arriving at tariff treatment of these materials. Treating exhaustively of manufacturing conditions, and the comparative cost of raw materials and labor north and south of the international boundary line, this report gave a flattering advantage to Canada in cost of manufacture of pulp and paper, representing a difference in mechanical or ground wood pulp of \$5.03 per ton, in sulphite wood pulp of \$5.52, and in newspaper of \$5.35 per ton. This lower cost in Canada was assigned chiefly to the difference in the price of pulpwood.

#### **Removal of Duties.**

United States duties were removed from paper, the product of Canada, manufactured from pulpwood cut on private lands, of a value not exceeding four cents per pound, at the extra session of Congress in midsummer. Duties were also removed from sulphite pulp and mechanical pulp when made from such wood. When the pulp and paper is made from Provincial lands wood, where prohibition is placed upon the export of wood, or where any discrimination against export exists, full duties are imposed. If the product is partly from one and partly from the other of these wood lands the duty is assessed only on the portion made from restricted wood. The

full duties are \$5.75 per ton on newspaper, 1-6 of one per cent per pound on sulphite pulp and 1-12 of one cent per pound on mechanical pulp.

#### **Trade With United States.**

Canada found a market in the United States in 1911 for approximately 55,000 tons of newspaper, valued at \$2,000,000, and 275,000 tons of wood pulp, valued at \$5,200,000, or a total of 330,000 tons, valued at \$7,200,000.

#### **Preferential Trade.**

Great Britain and the colonies took from us about 35,040 tons of paper, valued at one and a half millions. We also let the United States have about 900,000 cords, valued at \$5,800,000, of our pulpwood, with which to manufacture 720,000 tons of paper across the border.

#### **Imports of Paper.**

It is worthy of note that paper and pulp products and manufactures of the same were imported into Canada to the extent of \$5,000,000 during the last fiscal year. The British preferential tariff, admitting paper at two-thirds of normal duty, is considered prejudicial to the manufacture of Canadian wrapping papers.

#### **Increased Demand.**

The expansion in production during 1912 will be remarkable. In news paper it will be double; in book papers and wrapping papers and wood pulp the increase will reach 25 per cent. Canada is best adapted for the manufacture of news paper, the consumption of which increases at about ten per cent. per annum, taking America as a whole. Quebec leads the other provinces in this product, while Ontario follows closely, and British Columbia is breaking into the business in a large way. On the verge of another year a bright outlook is before the paper and pulp industry of Canada, in present and potential possibilities, and nothing can prevent it going forward by leaps and bounds.

## PULP AND PAPER MARKETS.

Toronto, Jan. 15, 1912.

Since our last issue, the holiday season has prevailed, but this seems to have made no difference to the rushing conditions in the paper business, except to make them still more marked in some lines. The news department was already overloaded with orders from the States, and we heard of some cases of Canadian mills having to obtain newsprint from American mills so as to be able to fulfil American orders. And there was an extra domestic demand for Christmas supplements, etc. Prices are very firm. The book and writing mills were temporarily quiet, but have been looking after orders for the current year and report satisfactory conditions, with no overload, however, of orders. Mills making wrapping paper seem to be sharing to some degree in the brisk business, and prices for manilas have in some cases advanced by  $\frac{1}{4}$ c. or so. In kraft, however, the cutting continues.

Fairly heavy rains two or three weeks ago did something to ease conditions in the ground wood industry, as they were general throughout Canada and the Eastern States. The result was a reduction in the prevailing prices, though as stocks were small, except in New York State, where some piling had been done, it was only a small retrogression and pulp is now selling around \$22 to \$24 delivered, although a little more for immediate shipment. There is a scarcity in sulphite, owing to the recent strike in Scandinavia. Unbleached is \$43 to \$44 delivered, and bleached about \$10 or \$12 higher.

We quote:—

News print, rolled .....	\$2.10 to \$2.20
News print, sheets .....	\$2.75
Book papers—Carload lots	
No. 3 .....	4 to 4 $\frac{1}{2}$ c.
Book papers—Broken lots	
No. 3 .....	4 $\frac{1}{2}$ to 4 $\frac{3}{4}$ c.
Carload lots No. 2 .....	4 $\frac{3}{4}$ c.
Broken lots No. 2 .....	5 $\frac{1}{2}$ to 5 $\frac{3}{4}$ c.
Carload lots No. 1 .....	5 $\frac{1}{2}$ to 6 $\frac{1}{4}$ c.

Broken lots No. 1 ..... 6 to 6 $\frac{3}{4}$ c.

## Wrappings—

Manila B. ....	2 $\frac{1}{2}$ to 3 c.
Fibre .....	3 $\frac{3}{4}$ to 4 c.
No. 2 Manila .....	3 to 3 $\frac{3}{4}$ c.
No. 1 Manila .....	3 $\frac{3}{4}$ to 4 c.
Kraft .....	4 $\frac{1}{4}$ to 4 $\frac{1}{2}$ c.

## Pulp—

Ground wood (at mill) ...	\$16 to \$18
Sulphite (bleached) .....	\$55 to \$56
“ (unbleached) .....	\$42 to \$44

## Waste Papers—

		Per 100 lb.
		F.o.b. Toronto.
No. 1 Hard White	Shavings .....	\$1.65 to \$1.75
No. 2 Hard White	Shavings .....	.....
White Envelope Cut-	tings .....	\$1.65 to \$1.75
No. 1 Soft White	Shavings .....	\$1.45 to \$1.50
No. 2 Soft White	Shavings .....	\$1.25
No. 3 Soft White	Shavings .....	\$1.10
White Blanks .....		\$1.10
Mixed Shavings .....	35 to 37 $\frac{1}{2}$ c.	
Heavy Ledger .....	\$1.27 $\frac{1}{2}$ to \$1.40	
Ordinary Ledger .....	\$1.00 to \$1.10	
No. 1 Flat Books .....	80 to 90c.	
No. 1 Book Stock .....	75 to 80c.	
No. 2 Book Stock .....	39 $\frac{1}{2}$ to 40c.	
No. 1 Manila Envelope Cuttings...	\$1.20	
No. 1 Print Manilas .....	65c.	
Railway Manilas .....	55c.	
Folded News Overissues .....	45c.	
Folded News .....	40c.	
Crushed News .....	.....	
No. 1 Mixed Papers .....	25 to 30c.	

## Rags (New and Old)—

		Per 100 lb.
1st Old White Cottons .....		\$2.00
2nd Old White Cottons .....		.....
Thirds and Blues .....	\$1.25 to \$1.45	
Roofing Stock—		
Flock Satinets .....	75 to 80c.	
Ordinary .....	55 to 60c.	
Tailor Sweepings .....	55 to 57 $\frac{1}{2}$ c.	
No. 1 White Shirt Cuttings	\$4.75 to \$5.00	
No. 2 White Sheet Cuttings.....	.....	
Fancy Sheet Cuttings .....	\$3.65 to \$3.75	

New Blue Prints .....	
New Blue Overalls .....	\$3.42½ to \$3.65
New Black Overalls .....	\$1.60 to \$1.70
New Black Linings .....	\$1.60 to \$1.75
New Unbleached Cottons .....	
Bleached and Unbleached Shoe Clips....	
New Light Flannelettes ..	\$3.75 to \$4.40
New Light Shirt Cuttings	\$3.90 to \$4.35
Light and Dark Cords .....	



### SCANDINAVIAN MARKETS.

C. E. Sontum, Canadian Trade Agent in Norway, states that owing to lack of rain only a few mechanical pulp mills in the Trondhjdm and Nandalen districts have full waterpower. Most of the other mills are running with half or less of their normal production. The prospects of material improvement in water conditions, he believes, are growing less each day. Sweden is no better off. The north Swedish mills experienced an improvement in water supply just as the north of Norway mills, while in middle and south Sweden there is great scarcity of water. It now appears that there will be a serious famine of mechanical pulp during the coming six months. The excessively high prices to which pulp must advance under these circumstances will be a serious matter for the consumers, while unfortunately the Norwegian makers will hardly reap any benefit therefrom since they will have so little to sell. Cellulose continues firm.



### LAKE SUPERIOR PAPER MILL.

Sault Ste. Marie, Ont., City Council and the Council of the Board of Trade unanimously decided to grant concessions to the Lake Superior Paper Company to the extent of exemption from taxation for twenty years, in return for the doubling of the plant now under construction and the employment of 500 more hands. The doubling of the capacity of the 200-ton mill also means the

early construction of several subsidiary companies which can use by-products successfully. It will be conducted by a corporation known as the Lake Superior Paper Mill, Ltd., which is one of the constituent companies of the Lake Superior Corporation. The president of the paper mill company is H. E. Talbot and the vice-president and manager, Geo. H. Mead. The new paper mill will at first contain two machines, but room is provided for four machines, which will be operated on newsprint. The company will make its own sulphite fibre and the present sulphite mill is closed down for reconstruction. It is expected that the new plant will be ready for operation in June or July.



A recent decision of the United States Treasury Department rules that pulp or paper from Canada, to enjoy free entry, must have been made from Canadian wood and manufactured in Canada.

\* \* \*

—The German Patent Office, which a few months ago refused the application for a patent on the Eibel invention on the ground of priority of invention by a rival, has now granted it, it being considered a master or basic patent, and the other a constructional one. It is rumored that those interested in the Eibel patents are considering the bringing of a test action against prominent Canadian newsprint manufacturers.

\* \* \*

To give an idea of the waterpowers available in Canada, it may be noted that, according to the report of the Commission on Conservation, the eleven rapids on the Nelson River will yield 6,500,000 horsepower. As several of these rapids are within a short distance of the new Hudson Bay Railway, it will thus be possible to operate this road by electricity. Where timber is available, the production of pulp should be a prospective industry, and such pulp could be shipped via Hudson Bay, even though the season of navigation were short.



### THIN INDIA PAPER.

When India paper was first introduced in Europe compactness did not mean at that period what it means to-day. It is for this reason that the promise of a more general employment of the thin book material seems to point to a new order of things, where the maximum of information will be compressed within the minimum space. In 1841 an Oxford graduate brought from the Far East a small quantity of paper of such thinness and strength that the university authorities naturally were greatly interested. But, while the twenty-four copies of the Bible manufactured from the paper proved a curiosity, more than thirty years had to pass before the ingenuity and experiments of Henry Frowde resulted in the manufacture of India paper at the Oxford University paper mills at Wolvercote. That the demand for Bibles printed on India paper became great was not unnatural. The feat of compression, taken in connection with the durability of the material as late as the Paris exposition of 1900, astounded visitors.

It would appear that, where large and heavy volumes may distract the seeker for information, the identical information compressed in such form as India paper makes available, necessarily lightens the quest. A large book not infrequently discourages investigation. Of course, many literary treasures are not to be put aside simply because the respective volumes are ponderous. But the fact that the book held before the eye nearly always has the advantage over the more formidable volume not suitable for the hand takes special point from the announcement that even heavy reference books are now being made compressed and lightened through the agency of thin paper.

It may be cause for regret that this continent has no India paper mill. Of the nine mills in the world, two are located in England, two in Germany,

two in Italy, while France, Holland and Belgium have one each. But no nation needs to take more account of compactness than the United States. American inventiveness is continually directed toward utilizing space. The architect of the present allows no more room within the house than he considers absolutely essential; and library-shelf requirements will be much less with big books reduced in size through the more general use of India paper. Where a material both tends to invite research and lends comfort to reading, its desirability would seem to recommend it for more general manufacture.



A significant fact in connection with recent events in Los Angeles is the formal withdrawal of the Canadian National Bookbinders from affiliation with international trades unionism. The statement sets forth that they are joining the Canadian Federation of Labor, which is "giving effect to the demand for the right of national autonomy, and the strongly-expressed dissatisfaction with the autocratic conditions existing in the present day so-called international trades unionism." It takes the ground that the Canadian working class is big enough, able enough, and more than intelligent enough to organize, legislate, make a policy for, and govern their own affairs in trades unionism as in everything else.

—Mr. Goldman, secretary of the Association of American Wood Pulp Importers, referring to our article on United States imports under favored nations clause, informs us that his association did not in its corporate capacity take any action in claiming for other countries the same rates as granted to Canada in pulp and paper, but such claims as were made were taken by the individual firms concerned with imports from these other countries.

## MOULD GROWTHS ON WOOD PULP.

By Frederick Barnes, Shawinigan Falls.

The following notes were obtained during the period when the writer acted as chemist to a large English paper mill using large quantities of mechanical and chemical pulps.

The mill in question kept large quantities of pulp stored in the open in large stacks, exposed to the weather for long periods of time. During the year 1907 some of the stacks of mechanical wood pulp were opened up and discovered to be seriously damaged by rot; to such an extent had the deterioration gone, that

these growths was a more or less blackish discoloration in the pulp produced by a microscopic fungus, described as a species of *Cladosporium*:

Fig 1 shows the mycelial threads of this fungus, sketched under a power of 700 diameters.

Fig. 2 shows the mycelium growing through one of the discoid markings of bordered pits of coniferous wood.

It is evident from this, Fig. 2, that the fungus is of very minute nature and its destructive power very great. This type of fungus is evidently responsible in most cases for the systematic decay of ground wood pulp, the main work of breaking down the fibre substance being

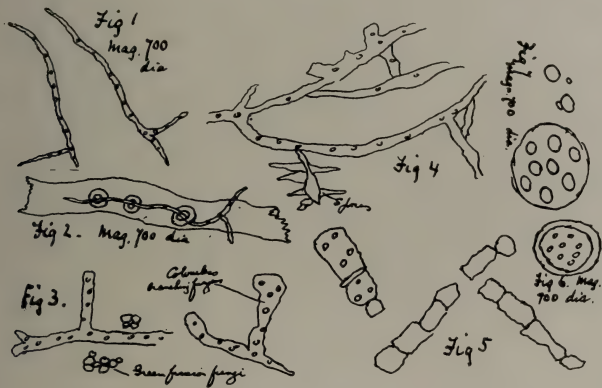

many a thousand dollars' worth of pulp was utterly ruined and 20 to 25 per cent. of the pulp was rendered soluble in water.

During the years 1908-1910, many shipments of both Scandinavian and Canadian pulps were found to be more or less damaged by fungoid growth and rot. The writer examined a large number of samples from the contaminated bales microscopically with the view of determining the main cause of the deterioration.

Numerous kinds of fungi and mould growths were observed, some of which are illustrated here. The chief effect of

done by enzymes emanating from the fungus.

The mycelium of this fungus was observed in most cases where decay had set in, though in the cases where the degradation had proceeded to a maximum, the mycelial threads (if any) had disappeared along with all trace of fibrous structure..

Fig. 3 shows a type of green fungus growing on the surface of the sheets of pulp in the interior of a bale of Norwegian hot-ground pulp. The mycelium of the fungus was colorless, the green color being due to quantities of green fission fungi.

Fig. 4 shows a type of white fungus growing on the surface of the sheets in the interior of a bale of mechanical pulp. The white threads were covered with spores. Large quantities of spherical and elongated cells, motile and otherwise, were present, also motile bacteria.

Fig. 5 shows a sample of Black fungus found in a bale of Nova Scotian pulp. This fungus was sparsely scattered through the pulp, but showed up very conspicuously, due to the relatively large dimensions of the growth.

Fig. 6 shows a type of organism preponderating in a sample of rotten Norwegian pulp.

Fig. 7 shows the fission fungi responsible for the decay of the outside edge of a bale of Quebec pulp. The interior of the bale was infected with the dark mycelia of *Cladosporium*. In this case, the fission fungi probably found a good feeding ground on the already infected pulp and rapidly rotted the external parts.

The Chromogenic moulds noticed were chiefly of a brick-red color; this particular mould only developed on bales which had stood exposed to the air for considerable periods. The growth was entirely a surface action, obviously aerobic in character. This type of mould had very little tendering effect on the pulp. Yellow and violet moulds were also noticed.

In one case, fungus had attacked some Swedish moist sulphite pulp. The sample examined was from a bale at the base of a stack, and was permeated with the mycelia of fungus; the cellulose fibres were broken up into short lengths as in rotten ground wood. The larger types of branching fungi, noted above, do not appear to deteriorate the pulp to a great extent, as they are of rapid growth and surface action.

To determine the rapidity at which fungoid growths and other discolorations in pulp increased in area, an experiment was conducted as follows: Five bales of pulp, contaminated in various ways, were taken. After thorough examination, all the conspicuous markings were

carefully outlined on the moist pulp with violet pencil; the bales were then removed and built up into a compact stack, surrounded on all sides, top and bottom, with moist sound bales. The stack was finally covered in with cotton felt and left untouched for six weeks, then re-opened and examined.

The discolorations pencilled off were: (1) Black fungoid growth at edges of sheets; (2) White branching fungus; (3) Small, dark grey spots (*Cladosporium*) scattered about sheets; (4) Greyish markings due to reaction of iron and tannin bodies; (5) Dark brown stains.

On re-opening the bales it was found that (1) The Black fungus had sensibly increased in area; (2) The White fungus had pushed into the bale far beyond its original limits; (3) The grey *Cladosporium* spots had increased slightly in area; (4) The grey iron stains had spread slightly; (5) The brown stain had increased about 20 per cent., well into the bale. These tests prove fairly conclusively that in the short space of six weeks a sensible increase in fungoid growth and in other contaminated areas had taken place, and serve to show the danger of keeping infected pulps in the stack for any length of time.

The brown stain in the pulp seems to have originated entirely from outside sources as it contained more tannin bodies than the unstained pulp. A probable explanation of this is that the bale had been placed on a wooden platform or wharf in contact with a pool of water rich in extractive matters from wood bark.

This sort of thing is to be avoided, as the more impurities an organic body contains, the greater tendency there is for that body to decay.

Experiments were also carried out to ascertain whether rotten wood pulp could affect sound pulp by direct contact. Pieces of rotten pulp were made up with good pulp into bundles and wired up, then incubated for several weeks. No trace of deterioration of the sound pulp could be detected when the bundles were opened up.

An investigation into the chemical characteristics of degraded pulp was made by the writer, the results of which may be included in a further article.



### BRITISH WOOD PULP ASSOCIATION.

The fifteenth annual general meeting of the British Wood Pulp Association took place at the London Chamber of Commerce on the 7th ult. In the absence of the president, Mr. Frank Lloyd, the chair was taken by Mr. F. E. R. Becker, chairman of the executive committee. An important matter for discussion was the contract note, a form of which has now been approved by the committee of the British Wood Pulp Association, as well as by the Paper-Makers' Association. One of the conditions of the contract now reads as follows:—

"The analyst shall test the pulp within ten days of the buyers' claim being made either at the consumer's mill, or at any other suitable place in the United Kingdom. Unless at least half the parcel is available at the mill or in transit for sampling and testing, no test shall be made, and the buyer's claim shall fail, and he shall pay any costs incurred by the seller by reason of the claim. The samples must be drawn from accurately weighed intact bales as nearly as possible in the manner agreed upon by the British and Scandinavian Pulp Associations and the Paper-maker's Association. At least 2 per cent. of the parcel must be tested, and in no case less than six bales. The analyst may, if he thinks fit, within three days test a further 2 per cent. of the parcel. The analyst's report as to the result of the test shall be final and binding on the parties; and the costs shall follow the result; but should the excess of moisture or of pulp not exceed half per cent., the original invoice shall stand, and the costs shall be paid by the buyer."

The committee could not agree to the form of contract, submitted by the Association of American Wood Pulp Importers for the purchase of pulp made in Europe for shipment to the United States and Canada for adoption by the British Wood Pulp Association.

Frank Lloyd was re-elected president, and F. E. R. Becker one of the vice-presidents, C. D'Oyley Mears, hon. secretary.

The proceedings concluded with a banquet at which J. E. A. Dubuc, president of the Canadian Wood Pulp Association was one of the speakers. Referring to the great victory won by Canadians against Reciprocity, he said the battle had been won on pulp and paper. He had confidence that the Province of Quebec would stand as firmly for its own interests, as the Dominion as a whole had done. The English paper-maker, with pulp from Canada—he would be generous and allow 30 per cent. for Norway and Sweden—would be able to send and sell his paper in the harbors of the United States in competition with the whole of the present mills. He believed that was a thing they all looked for and a thing they should be proud of. He had an idea that they would see the day when the British paper-maker with pulp from Canada, could send to the United States and compete with the mills they had there. That was a thought that was Imperial, and it was the thought of the people of Canada. In conclusion, the speaker expressed the hope that in future years circumstances would again permit him to have the pleasure of meeting those who had so charmingly entertained him that evening.



The Purity Paper Bottle Co., Washington, D.C., which makes bottles of stiff paper resembling cardboard, waterproofed, and guaranteed to hold liquids for 24 hours, may establish a branch plant at St. John, N.B.

**NOTES FROM NEWFOUNDLAND.**

(Special to Pulp and Paper Magazine.)

The Donaldson liner, Marania, loaded at Botwood the first of December, taking 600 tons of paper and 8,000 tons of pulp, and sailed for London, England.

\* \* \*

The S.S. Parthania arrived at Botwood the first of the month, bringing 6,000 tons of coal and 500 tons general cargo. She will take away 800 tons of paper and about 7,500 tons of pulp.

\* \* \*

The Anglo-Newfoundland Development Co.'s ice-beaker, the Tritonia, has just loaded with 2,800 tons of paper and 2,000 tons of pulp for London. This about finishes the shipments of pulp and paper from Botwood for the present season. The Tritonia will, however, make two trips to this country during the winter, but will likely load at St. John's, as navigation on the Exploits River will be closed owing to the presence of heavy Arctic ice on the outer coast.

\* \* \*

During the installation of a new water wheel, the A. N. D. Co.'s paper mills at Grand Falls were stopped three days. The company took advantage of the stopping of the machinery to effect other repairs.

\* \* \*

The A. N. D. Co., owners of the great paper mills at Grand Falls, Nfld., have recently issued their annual report and statement of accounts for their year ending August 31, 1911. It shows the profits of the company for the past year to have been £34,665 18s. 5d., after making due provision for depreciation of all plant and machinery and logging gear, and for depreciation of houses, furnishings and other equipment. The directors have written the sum of £4,000 off the cost of issuing debenture stock, also £3,499 4s. 6d., which was expended in alterations to the S.S. Tritonia for winter shipping. The report goes on to

say that "the period covered by the present report and statement of accounts practically marks the close of the construction period, although it will not be until early next year that all construction work at the mill will be completed, and the company will begin to get the benefit of the full output of the mill. The past year's profits have been earned on barely one-half of the output of the completed plant."

\* \* \*

Some American capitalists interested in the pulp and paper business, and who have options on some timber limits in Newfoundland and Labrador, are looking for some concessions in the present Newfoundland timber laws, and some correspondence has already taken place between the interested parties.—A. L. B.

**DR. WILEY'S WORK.**

Dr. H. W. Wiley, Chemist to the United States Department of Agriculture, in his annual report, refers to paper as follows:

"The work on paper making materials that are used but little and on improved processes of treatment, has been continued with very encouraging results. It has been fully demonstrated that the waste pine wood of the South and Northwest is suitable for the manufacture of certain grades, especially manila wrapping, box boards, and other strong papers. As there are large quantities of this waste wood, its use for this purpose would greatly relieve the pressure on other woods better suited to make white paper. It has been shown that at a moderate estimate the value of the pulp, rosin, turpentine, and rosin oils obtained from a cord of pine wood is more than \$40. The utilization of this waste material in this way is earnestly commended to paper makers and investors, and constitutes one of the most promising fields for industrial development. The results of this investigation have also been compiled."



### CONVENTION OF THE CANADIAN FORESTRY ASSOCIATION.

The thirteenth annual meeting and convention of the Canadian Forestry Association, under the patronage of H.R.H. the Governor-General, for the reading and discussion of papers, the reception of reports, election of officers, and other business, will be held in the Railway Committee Room, Parliament Buildings, Ottawa, on Wednesday and Thursday, Feb. 7th and 8th, 1912, and to it all friends of forest conservation are invited.

The aim is to make this the most practical convention yet held and to this end the gentlemen who will read papers and make addresses will direct their attention to subjects now pressing for immediate solution in Canada.

The convention will be opened at 10 a.m., Wednesday, Feb. 7th. Among those who are expected to be present and to take part are Rt. Hon. R. L. Borden, Rt. Hon. Sir Wilfrid Laurier, Hon. Robert Rogers, Minister of the Interior; Hon. Martin Burrell, Minister of Agriculture; Mr. Gifford Pinchot, of Washington, D.C.; Mr. Henry S. Graves, U.S. Forester, Washington; Hon. W. R. Ross, Minister of Lands of British Columbia; Mr. R. H. Campbell, Director of Forestry, Ottawa; Dr. B. E. Fernow, Dean of the Faculty of Forestry of the University of Toronto; and Mr. E. A. Sterling, Forester Pennsylvania Railroad Co.

The feature of the programme for Wednesday evening, Feb. 7th, will be a banquet, which will be participated in by the members of the Canadian Lumbermen's Association, as well as the members of the Canadian Forestry Association, and the friends of both. It has been decided to put this on a ticket basis so that all desirous of attending may have an opportunity of so doing. The price of the tickets will be three dollars (\$3). Tickets may be obtained from the secretary. It is requested that applications for tickets be made as early as possible so that full accommodation may be provided in advance.

The annual business meeting of the Canadian Forestry Association for the passing of accounts, election of officers, transaction of business, etc., will be held in the Railway Committee Room on the afternoon of Thursday, Feb. 8th.

Notice is given of two motions, one to increase the number of directors and another to place the decision as to place and date of holding annual meetings and conventions in the hands of the directors. Further particulars may be obtained from James Lawler, Secretary Canadian Forestry Association, Canadian Building, Ottawa.



### AMERICAN PAPER AND PULP ASSOCIATION.

The 35th annual meeting of the American Paper and Pulp Association will be held at the Waldorf-Astoria Hotel, New York, on Wednesday and Thursday, 14th and 15th prox. The first day will be used for meetings of the different divisions of the paper trade, while changes and suggestions as to trade customs, etc., will be ratified, if so decided, at the general meeting on the 15th. The annual banquet of the association will take place on the evening of the 15th, the price of tickets being \$10 each. Clarence I. McNair is secretary.



The province of Quebec on May 14th ult. will offer about 15 waterpowers, varying from 130 up to 14,000 horsepower, for sale by public auction. The yearly rental will consist of an annual amount, being the upset price on which will bear the bids exclusively, and also an additional royalty per developed horsepower to bear on a fixed minimum of development. Particulars can be obtained from the Department of Lands and Forests, Quebec City.

The St. Croix Paper Co.'s warehouse in Halifax, N.S., has been burned down.

## METHOD OF MAKING IMITATION WATERMARKS.

By Gustaf Fornstedt.

In many cases the orders submitted for paper with watermarks are too small to be executed, as it would not pay to procure a special dandy roll for that purpose. Hence, as the result of protracted experiments, many European paper mills have adopted a process of making imitation watermarks, which are produced on the same principle as imitation linen paper, by means of plates on which a paste has been spread.

The manipulation employed is as follows:—

1. The design is drawn in sharply defined lines on tracing paper, with India ink, of a character which will arrest the passage of light.

2. The design thus drawn is transferred to a silver chloride diapositive plate, preferably in bright sunshine, when the best copy is obtained. The copying is continued until the silver chloride, which at first is violet, has acquired a clear red tone, while the lines retain their sharpness.

3. After having been copied, the plate is fixed in a solution of  $\text{Na}_2\text{SO}_3$ , in one liter (two pints) of water. The layer deposited at first displays a white coating, which disappears. The plate is then retained in the bath for about five minutes, when it assumes a light brown shade, which becomes a trifle darker in the toning.

4. When the fixing is completed, the plate is kept for two hours in running water, after which it is allowed to dry, and is then ready for use.

5. The solution of glue with which the plate is covered has the following composition: Water, 11 liters (2.90 gallons); animal glue, 2.5 kilos ( $5\frac{1}{2}$  lb.); gelatine, 25 sheets; alcohol, 1 liter (two pints); glycerin, 200 grammes (7 oz. by weight); ammonia solution, 50 grammes ( $1\frac{1}{2}$  oz.).

The glue is first soaked in the water and heated to 185 deg. F. until it is

completely softened, when the glycerin and gelatine are added, and finally the alcohol and ammonia, after the mixture has cooled to about 115 deg. F.

The paper on which the glue is poured ought to be thoroughly moistened in warm water and then placed on a perfectly horizontal wet glass plate. The superfluous water is absorbed with a sponge and the bubbles which may appear between the paper and the glass, are removed by pressure. Then the edge is bent the whole way round to a width of one centimeter (one-third inch) wide. The glue is poured over the paper while warm, and sufficiently even to prevent the formation of air bubbles, while  
(Continued on Page xxxii.)



## AMERICAN NEWSPAPER PUBLISHERS' ASSOCIATION.

John Norris, on behalf of the American Newspaper Publishers' Association, sends out the following bulletin on the news print paper situation:

The news print paper market is in a state of transition, due to numerous shifts of orders which are pending. An output of over 1,000 tons of new production in 1912 is likely to affect prices. The demand of favored nations of Europe for the admission of free pulps and paper, if granted, as is possible, will also influence prices.

The larger news print paper companies have been soliciting orders recently. That is a hopeful contrast with their methods in previous years when closing contracts. The International Paper Company is holding out for \$2.25 when delivered on sidewalk to large consumers. Some other paper makers are selling at slightly lower prices, especially to smaller consumers. If opportunity offers, publishers should stipulate in contracts for paper supply for the year that the paper maker meet the market during the life of the contract. Some of the paper makers make such a stipulation.

**Attempting to Repeal Reciprocity Act.**

Five bills have been offered in Congress to repeal the Canadian Reciprocity Act. Congressman Mott, of New York, has introduced a bill to repeal Section 2 of that Act admitting Canadian pulps and paper free of duty. The bills have been referred to the House Committee on Ways and Means and to the Senate Committee on Finance.

**Eighty-One New Paper Companies Incorporated.**

Eighty-one (81) paper manufacturing concerns with an authorized capital of \$83,061,000, have been incorporated within seven months. Forty-nine (49) of these companies with a capital of \$41,253,000, to develop pulp tracts or to build pulp and paper mills, have been incorporated since the passage of the Reciprocity Bill. Twenty-seven (27) of these have been incorporated in Canada and twenty-two (22) in the United States.

The Sturgeon Falls (Canada) Paper Mill, which has been idle for five years in the hands of receivers, has been sold to a Canadian syndicate represented by the Dominion Bond Company, which is also interested in the Spanish River Paper Mill at Espanola, Ontario. The Sturgeon Falls Mill has a capacity for fifty tons of news print paper which, when put upon the market, will add that much to the production. It is understood that the mill's output of ground wood will be increased sixty tons per day and its sulphite pulp output seventy-five tons per day.

The Riordon Pulp and Paper Company will build a fifty-ton news print paper plant at Calumet, Ontario, beginning work in the spring with the idea of producing paper before January, 1913.

The Chicoutimi Pulp Mill will increase its output of ground wood to 350 tons per day, an increase of 140 tons per day.

The McLaren Mill at Buckingham, Quebec, will add thirty tons per day to its output of ground wood.

Delays in construction work have prevented the starting up of new paper mills and have kept them out of the market. The Powell River Mill, in

British Columbia, with capacity for 100 tons per day, which was to have started on August 15, is not yet on the market. The latest report fixes next week as the time of starting. The Spanish River Mill, which was to have started December 1st with 100 tons per day, has been held back by delay in delivery of structural steel.

The slowness with which paper manufacturing readjusts itself to new conditions is well illustrated by the fact that of the news print paper which was shipped to this country from Canada in September, more than half of it paid the duty of \$5.75 per ton, though it was admissible free of duty if made from unrestricted wood. A slight improvement in the proportions was noticeable in the month of October, 58 per cent. having been admitted free of duty. The delay is due to the fact that time is required by manufacturers to arrange for their supplies of unrestricted wood which is essential to the avoidance of the paper duty.

One Canadian mill (Booth's) reports it is so glutted with orders from American publishers for paper that it has been forced to buy paper from American mills to fill its contracts with its American customers.

**New Output of Paper and Pulp.**

The new output of news print paper in sight for production during the year 1912 exceeds 1,000 tons per day, as follows:

	Mill.	Output in Tons Per Day.
1911 Dec.	Powell River, B.C.....	100
1912 March	Spanish River, Ont....	100
" April	Tidewater, N.Y. City..	100
" "	Degrasse, N.Y. ....	55
" "	Anglo, Newfoundland.	85
" July	Jonqueres, Que. ....	150
" August	Sault Ste. Marie Ont..	200
" Dec.	Riordon, Ont. ....	50
" "	Belgo-Canadian, Que.	55
" "	Fort Francis, Ont. ...	55
" "	Sturgeon Falls .....	55

There is a possibility that some of these plants may further increase their output during the year to the extent of 300 tons per day if market conditions are favorable. This schedule omits all calculation of possible additions to output by:—Laurentide, Grand Mere, Que.; St. Croix, at Woodlands, Maine; Northwest, at Brainerd, Minn.; Parks Paper Company, Fitzdale, Vt.; Campbell Lumber Co., Weymouth, N.S.; Inland Empire Company, Spokane; Partington Paper Mill, Fairville, N.B.; Escanaba, Mich.; Haileybury, Ont.; International Land and Lumber Co., Ottawa; Gres River Falls, Que.; Pentecost, Que.

The new output of mechanical pulp, in addition to that covered in above tabulation, is reported as follows:

	Output— Tons Per Day.
Chicoutimi, Que. ....	140
Eella Ccola, B.C. ....	150
Wayagamack, Que. ....	100
Union Bag and Paper Co. (Three Rivers), Que. ....	60
Brompton, Que. ....	60
McLaren, Buckingham, Que..	30
Campbellford, Ont. ....	12
Bronson, Ottawa ....	30
Yaleville, N.Y. ....	25
Thorold, Ont. ....	40
-----	
Total ground wood .....	647

The above compilation excludes possible developments affecting the paper market by:—Berlin Mills Company, at La Tuque; Three Rivers, Que.; Dryden Timber and Power Company, Ont.; Pearson Mill, El Paso, Texas; Southern Paper Company; Moss Point, Mississippi; Bishop's Falls, Nfld.



The Foley-Rieger Co. purchased the cargo of pulpwood from the S.S. "Raleigh," which was wrecked off Port Colborne recently on its way from Quebec to Cleveland.

### ARTHUR D. LITTLE ELECTED PRESIDENT OF THE AMERICAN CHEMICAL SOCIETY

Mr. Arthur D. Little, who was elected president of the American Chemical Society at its annual meeting in Washington, is president and general manager of Arthur D. Little, Inc., chemists and engineers, 93 Broad Street, Boston, Mass. He has previously held the position of vice-president of this society, and has been chairman of the Division of Industrial Chemists and Chemical Engineers. He was educated at the Massachusetts Institute of Technology, being a member of the Class of '85, and has been in independent practice for many years, having identified himself in the early days with the development of the sulphite process for wood fibre, chrome tanning, electrolytic bleaching and chlorate manufacture. He is a specialist in the chemistry of cellulose and fibres, fibre treatments and paper making, being the Official Chemist of the American Paper and Pulp Association, and the author of "The Chemistry of Paper Making." He is prominent in connection with the great International Congress of Applied Chemistry, which is to be held in this country next year, and is president of the section on starch, cellulose and paper. His notable popular paper on "The Earning Power of Chemistry," which was read at the Indianapolis meeting of the American Chemical Society last year, has attracted wide attention to the practical applications of chemistry in the reduction of costs in all fields of activity.



The Dominion Customs Department has given the following decisions:—Covers on books of wall paper, per samples, embossed, bearing certain imprints, to pay 15c. under general tariff and 10c. under British preferential. Oiled cardboard, show cards, with certain inscriptions, 15 and 10 cents respectively.

---

# EMERSON MANUFACTURING CO.

## LAWRENCE, MASS.

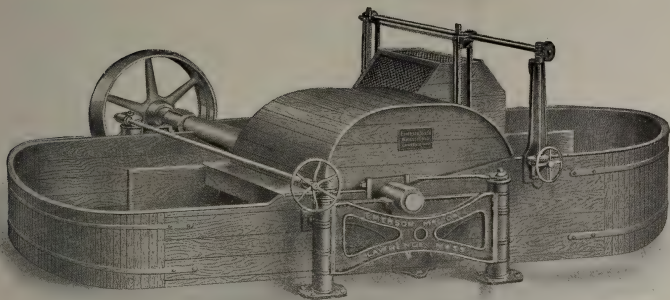

Beating and Washing Engines  
Paper Mill Machinery

---

**THE UNITED WIRE WORKS LTD,**  
EDINBURGH, GLASGOW & NEWCASTLE-ON-TYNE  
**FOURDRINIER WIRES, CYLINDER WIRES,**  
AND WIRE CLOTH OF ALL KINDS.  
AGENTS, ARTHUR P. TIPPET & CO 8 PLACE ROYALE MONTREAL.  
WIRES HELD IN STOCK AT MONTREAL FOR PROMPT DELIVERY.

# ARTHUR P. TIPPET & CO.

Agents and Importers  
**PAPER MILL SUPPLIES**  
**SULPHUR FELTS**

Sal Ammoniac,

Borax,

Santitie, etc.

MONTREAL

-

TORONTO



# CLASSIFIED ADVERTISERS' INDEX.

If you fail to find what you want in these columns, write us and the desired information will be gladly supplied.

## Architects and Engineers

Ambursen Hydraulic Con. Co.  
Fred C. Anderson  
Clark & Lyford  
F. W. Dean  
J. A. DeCew  
Eaton & Brownell  
Fibre Development Co.  
Geo. F. Hardy  
Herbert S. Kimball  
International Process Co.  
Arthur D. Little, Inc.  
R. S. Lea & H. S. Ferguson  
Lyford, Clark & Lyford  
H. B. Prather  
T. Pringle & Son  
Stebbins Eng. & Mfg. Co.  
R. O. Sweezy  
Jos. H. Wallace & Co.

## Barkers.

Green Bay Barker Co.  
Jenckes Mach. Co.  
Waterous Engine Works.

## Barker and Chipper Knives.

Crookes, Roberts & Co.  
Peter Hay Knife Co.  
A. P. Tippet & Co.

## Beaters.

Dayton Globe Iron Works  
Emerson Mfg. Co.  
Holyoke Mach. Co.  
E. D. Jones & Sons Co.  
Valley Iron Works  
Waterous Engine Works

## Beater Rolls.

J. A. DeCew  
J. Marx & Co.

## Belting.

Dom. Belting Co.  
General Supply Co.  
F. Reddaway & Co.  
Sadler & Haworth

## Bleaching Powders.

Hooker Electro-Chemical Co.  
Winn & Holland

## Bond Papers.

Northern Mills Co.

## Book Papers.

Canada Paper Co.  
Northern Mills Co.

## Brass Wire Cloth, Foudriner Wires.

Geo. Christie, Ltd.  
J. M. Douglas & Co.  
Herman Finckh  
C. H. Johnson & Sons, Ltd.  
A. P. Tippet & Co.  
United Wire Works.  
P. P. Westbye

## Calendar Rolls.

Farrel Foundry & Mach. Co.

## Chemicals, Colors, etc.

Brunner, Mond & Co.  
Gewerkschaft Sachtleben  
A. Klipstein & Co.  
Paper Makers' Chemical Co.  
United Alkali Co.  
Wilson-Paterson Co.

## China Clay.

China Clay Co.  
A. Klipstein & Co.  
C. A. Meincke & Co.  
Paper Makers' Chem. Co.  
Wilson-Paterson Co.

## Chippers

Carthage Machine Co.

## Coated Paper.

Canada Coating Mills  
Canada Paper Co.

## Conveying Machinery.

Jeffrey Mfg. Co.

## Digester Lining.

Panzl Digester Lining Co.  
Preston's Digester Lining Co.  
Stebbins Eng. & Mfg. Co.

## Drainer Bottoms.

Samuel Snell Co.

## Evaporators

Ernest Scott & Co.  
Swenson Evaporator Co.  
Zaremba Company

## Felts.

F. Bredt & Co.  
Dallyn, Jardine & Co.  
Hamelin & Ayres Co.  
C. H. Johnson & Sons, Ltd.  
Penman's Ltd.  
Joseph Porritt & Sons.  
J. H. Spencer & Sons  
A. P. Tippet & Co.

## Grinders.

Dayton Globe Iron Works  
Glens Falls Mach. Co.  
Holyoke Machine Co.  
Jenckes Machine Co.  
Waterous Engine Works.

## Kraft Paper.

N. B. Pulp & Paper Co.

## News-Paper, Wrappings, etc.

New Brunswick P. & P. Co.  
Riordon Paper Co.

## Paper and Pulp Dealers

Atterbury Bros.  
Castle, Gottheil & Overton.  
Parsons Trading Co.  
Pulp and Paper Trading Co.  
A. Wertheim & Co.  
Riordon Paper Co.

## Paper Stock, Rags, etc.

Atterbury Bros., Inc.  
J. Christie Co.  
R. Hough  
The Howell Co.  
E. Pullan  
J. R. Walker & Co.

## Paper and Pulp Mill Machinery.

Appleton Machine Co.  
W. G. Ashdown  
Baker & Shevlin Co.  
Beloit Iron Works  
Bentley & Jackson  
James Bertram & Son, Ltd.  
Bertram's, Limited  
The Black-Clawson Co.  
Canadian Boving Co.  
Carthage Machine Co.  
Dayton Globe Iron Works Co.  
Dillon Machine Co.  
Emerson Mfg. Co.  
Farrel Foundry & Machinery Co.  
M. Garland Co.  
Glens Falls Machine Works.  
Green Bay Barker Co.  
Harmon Machine Co.  
Holyoke Machine Co.  
Jenckes Machine Co.  
E. D. Jones & Sons Co.

## C. H. Johnson & Sons, Ltd.

Jas. Milne & Sons.  
Moore & White Co.  
B. F. Perkins & Son.  
Rice, Barton & Fales  
Ryther & Pringle.  
Sandy Hill Iron & Brass Works.  
Ernest Scott & Co.  
Sherbrooke Machinery Co., Ltd.  
S. Morgan Smith.  
Stebbins Engineering & Mfg. Co.  
Swenson Evaporator Co.  
Ticonderoga Machine Works.  
Valley Iron Works.  
J. M. Voith.  
Charles Walmsley & Co.  
Chr. Wandel.  
Wandel Screen Mfg. Co.  
Waterous Engine Works Co. Ltd.  
P. P. Westbye.  
Zaremba Co.

## Paper Testers.

Dobler & Mudge.

## Pipes (Wooden)

Eastern Pipe & Construction Co.

## Pumps.

Lawrence Pump & Engine Co.  
John McDougall Caledonian Iron Works.  
Smart-Turner Mach. Co.

## Rosin Size.

Paper Makers Chemical Co.  
Vera Chemical Co.  
United Alkali Co.  
Wilson-Paterson Co.

## Screen Plates.

Union Screen Plate Co. of Can.

## Screens.

W. G. Ashdown  
Harmon Machine Co.  
Sherbrooke Machinery Co.  
J. M. Voith.  
Chr. Wandel.  
Wandel Screen Mfg. Co.  
Waterous Engine Works.  
P. P. Westbye.

## Sulphur.

Union Sulphur Co.

## Tanks.

G. Woolford Wood Tank Mfg. Co.

## Transmission Machinery.

Dodge Manufacturing Co.

## Travelling Cranes.

Advance Mach. Co.  
Hugh R. Blethen  
Northern Eng. Co.  
Smart-Turner Mach. Co.

## Turbines.

Dayton Globe Iron Works.  
S. Morgan Smith Co.

## Water Wheels.

Dayton Globe Iron Works.  
Holyoke Machine Co.

## Wood Pulp Agents.

Castle, Gottheil & Overton.  
Parsons Trading Co.  
Scandinavian Amer. Trading Co.  
A. Wertheim & Co.

**CANADIAN EXPORTS OF PULP.**

According to information furnished to the Forestry Branch by the Dominion Department of Trade and Commerce, Canada's export trade of wood pulp during 1910 amounted in value to five million, seven hundred thousand dollars. The three hundred and twenty-nine thousand tons of pulp exported was an increase of forty-eight thousand tons over the amount shipped in 1909. Wood pulp exportations in 1910 amounted to seventy per cent. of the total produced in Canada, whereas in 1909 the proportion was only sixty-three per cent. Eighty-eight per cent. of the export was mechanical pulp and the remaining twelve per cent. was chemical pulp. During 1910, over three-quarters of the pulp exported went to the United States, while shipments to nearly all other countries decreased. The United Kingdom takes most of the remaining one-quarter, although exports to these

countries have fallen off greatly. Particularly is this so with chemical pulp, not one-seventh the amount being shipped in 1910 as in 1909. The average value per ton of the pulp exported in 1909 was \$14.67 for the mechanical and \$36.35 for the chemical pulp. This is a combined average of \$17.31, or 14 cents less per ton than for the previous year. The prices paid to Canadian exporters by the various importing countries were per ton for mechanical pulp in United States \$16.09, or exactly the same as in 1909, and United Kingdom \$15.78, or \$5.52 more. For chemical pulp, the amounts paid were, United States, \$36.32 per ton, and United Kingdom, \$41.60 per ton.



In Frankford, Ont., there was a serious fire a week or two ago, but the paper mill fortunately escaped, the employees working hard to keep the flames away.

**WANTED**

by a British Mill, making high class S/C. and M/F. Printings, Cream Laid, Bond Papers, Bank, Drawing Cartridges, Duplex and Triplex Boards, Manillas, etc., a thoroughly capable man as sole Representative for Canada. Applications in confidence stating full particulars to Box, 48, "Pulp & Paper Magazine," Toronto.

Edward A. Jones, President and Treasurer.

Wallace E. Bardwell, Secretary.

**E. D. JONES & SONS CO., Pittsfield, Mass.**

Manufacturers of

**PAPER MAKING MACHINERY  
AND MECHANICAL ENGINEERS**

Beating Engines. Washing Engines. Mixing Engines. Bleaching Engines.  
Cooking Engines. Vertical and Horizontal Stuff Chests.

Jordan Engines of three sizes, either belt or direct-connected motor-driven;  
fillings of Wagg Steel or stone type, three-part or plain.  
Dusting Machinery of all kinds.

# For Reliable Service

on wet or damp drives  
always use

# “AMPHIBIA”

(WATERPROOF)



## LEATHER BELTING

Which is as impervious to moisture as a frog, and will end all the trouble you have with belts that will *not* stand dampness. Thirty-four years of concentrated effort are behind the manufacture of this belting.

We have a bully trial offer to make to you—one without a sign of a string attached.

Spend a cent—send a post card to-day, *NOW!!*

*Sadler & Haworth*

MONTREAL  
511 William St.

TORONTO  
27 Melinda St.

ST. JOHN, N.B.  
89 Prince William St.

WINNIPEG  
244 Princess St.

VANCOUVER  
217 Columbia Ave.

PRIME . . .  
CANADIAN CHICOUTIMI,  
P.Q., CANADA.  
SPRUCE PULP

SUPPLIED BY THE

**CHICOUTIMI**  
**Pulp Co.**

Production: About 100,000 tons.

SOLE AGENTS:

**BECKER & CO.**

LIMITED

64 CANNON ST., - LONDON.

# IMPROVED DAYTON BEATERS

are made in all sizes with  
either wood or iron tub.

They meet the requirements of modern paper mill equipment, are operating satisfactorily in many of the recently built mills, and are favorably considered by many of the prominent engineers in the United States.

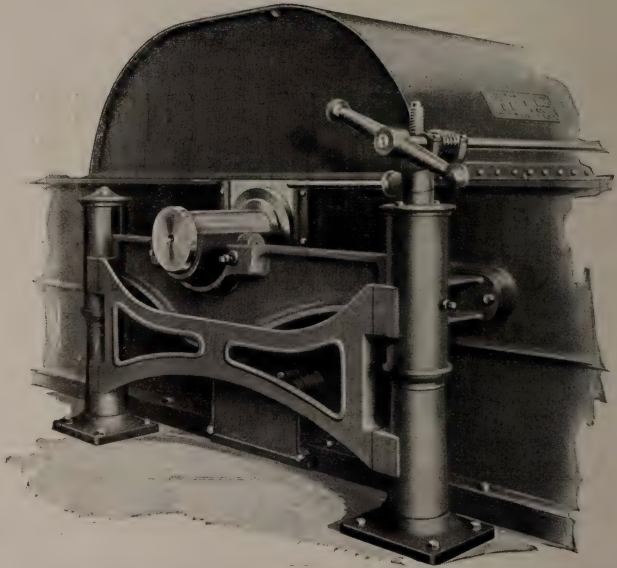

Note the substantial construction of the Lightening Rig, and the manner in which the columns are connected together and also bolted to the side of the tub; also the quick relief lever for emergency.

**WE ALSO BUILD TURBINE WATER WHEELS, HEAD GATE HOISTS, ETC.**

If interested, send for Catalogue No. 27.

**THE DAYTON GLOBE IRON WORKS COMPANY**  
**DAYTON, OHIO, U.S.A.**



---

---

# BEATING AND WASHING ENGINES

IRON OR WOOD TUBS

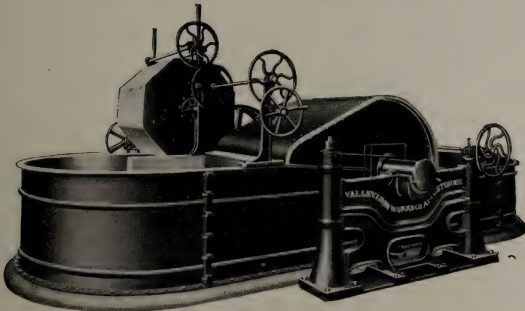

PERFECTION IN EVERY DETAIL

Beating, Washing and Bleaching Engines. Barkers—Barker Attachments  
—Chippers—Rechippers—Chip Screen (Revolving)—  
Knot Screen (Revolving)—Diaphragm Screens—Felt Washers—Deckers  
(Single and Double)—Stuff Chests (Vertical and Horizontal)—  
Tanks (Blow Off, Acid and Water)—Pulpwood Saws (Friction and  
Steam Feed)—Pulpwood Splitters (Vertical and Horizontal)—  
Shredders and Special Washers for old Paper Stock—Wet Machines and  
Patent Roll Skinners—Bronze, Semi-Steel, Lead and Iron Castings.  
Manufacturers of Paper and Pulp Making Machinery in

All Standard Forms AND Many Special Designs

ENGINEERS, FOUNDERS AND MACHINISTS

*Correspondence Invited*



**VALLEY IRON WORKS CO.**

Appleton, Wis., U.S.A.

---

---

## METHOD OF MAKING IMITATION WATERMARKS.

(Continued from Page 32.)

those which may eventually appear should be brought to the side by the finger while the glue is still warm. For an area of 5,000 square centimeters (775 square inches) one liter (two pints) should be used, but no larger area should be covered at one time. The paper used should be of good strong rag quality, of about 140 lb. weight.

After the glue is cold and stiff, the paper is removed from the glass plate and hung up to dry.

6. When the glass plate is completely dry it is sensitized in a bath of the following composition: Water, 9 liters (2.37 gallons); ammonium chromate, 500 grammes (17.59 oz.); solution of ammonia, 500 c.c. (17.59 oz.); alcohol, 500 c.c. (17.59 oz.)

The mixture is poured into a shallow vessel, and in this the glued paper is kept until the surface acquires a downy feel; this process ought to be carried out in a dark room, where the glass plate is immediately dried. The drying process should not take longer than twelve hours, at a temperature of at least 65 deg. F. The finished paper does not last long, being permanent for a few days only.

7. By means of the silver chloride plate referred to, the design is copied on the sensitized glue plate, the operation being best conducted in strong sunshine, until the lines appear sharply defined in black, without the rest of the plate appearing darker.

8. The glue dissolved from the plate is removed by the gentle application of water at 140 deg. F., in such a way that only the design is left on the paper. The latter is then dried and mounted with wheat starch on a cardboard of ten to twelve sheets each of good strong paper about 140 lbs. If the photometer is used, the glue paper can be sensitized with potassium dichromate.

## OPENINGS IN CUBA.

According to latest figures, directly obtained from the Cuban Treasury Department, wrapping paper to the amount of \$105,010 was imported during the fiscal year 1909-1910. There are one or two factories in Cuba that manufacture this kind of paper, but their output is far below the local demand. Inasmuch as wrapping paper is also imported from other countries than the United States, who alone enjoy the preference of the reciprocity tariff, there is no reason why Canada should not get a large share of the trade.

Over 170,000,000 paper bags are imported annually by one firm in Havana alone, and this is only a small proportion of the consumption. Every assistance will be given Canadian exporters by the Canadian trade agent in Havana to secure a footing in this market.

The following are the imports of pulp and news print into the Island:—

### Wood pulp and newspaper—

United States .....	\$148,916
Canada .....	5,356
Germany .....	32,331
Belgium .....	6,943
France .....	44,730
Holland .....	1,692
United Kingdom .....	1,410

---

\$441,384

There is a belief among a large number of Canadian exporters that the preferential tariff enjoyed by the United States through reciprocity treaty with Cuba is of such a nature as to shut them entirely from this market. There are instances in which this handicap practically excludes all competition not only from Canada but every other country as well; but this is only confined to a limited number of cases. On the other

(Continued on Page xlv.)

# PAPER AND CLOTH SPECIALTIES

For Rent and Club Cards, Pattern Cards, Map Printing,  
Label Printing, Envelopes, Etc., Etc.

*Cloth Lined Papers. Cloth Centred Papers and Boards. Cloth Lined, Chromo and Enamel. Cloth Lined Boards and Cards, (surfaced and enamelled). Cloth centred Boards, (surfaced and enamelled). Manilla Surfaced Boards and Cards.*

ALSO

*Ename led Blotting.*

*Paste Boards.*

*Art Papers.*

*Chromo and Surface Papers.*

Customers' requirements in specialities are carefully considered and experiments conducted if necessary.

**ALBERT E. MALLANDAIN,**

51, Cheapside,

- - London, England.

# HERMANN FINCKH

REUTLINGEN

*Established 1879*

GERMANY

---

# FOURDRINIER WIRES

---

**SULPHITE - MACHINE WIRES  
CYLINDER WIRES**

---

**P. P. WESTBYE, - Peterborough, Ontario**

*Sole Agent for Canada*

**PRESTON'S**

# Lining for Sulphite Digesters

TOTAL THICKNESS ONLY  $2\frac{1}{2}$  TO  $2\frac{3}{4}$  INCHES

Resists the action of the acid and ensures absolute protection to the Digester Plates.

Great durability, therefore large saving in upkeep and repairs.

Larger internal space and increased production on account of the small thickness occupied.

Extensively adopted by Scandinavian and Continental Mills.

Over 200 Digester Linings in work and on order.

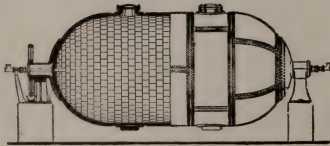
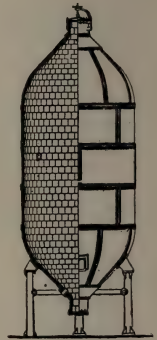

Telegraphic Address :

**"PRESTONS, RADCLIFFE."**

CODE USED, A.B.C. 4TH & 5TH EDITION.

*Full Particulars and Prices on application to SOLE MANUFACTURERS*

**PRESTON'S DIGESTER LINING CO., LIMITED**

**RADCLIFFE, near Manchester, Eng.**

## THE PERKINS BRONZE SIZE PUMP



The simplest and most efficient means for pumping Size to a Paper Machine. Will last a lifetime. Write for special circular with list of references.

B. F. PERKINS & SON, Inc.,

HOLYOKE, MASS.

## FROZEN PULP AND DRY PULP IN A

# Ryther Shredder

Is shredded at the rate of 5 tons per hour.  
17 to 25 H. P. required. The above figures are  
*dry weight* and absolutely guaranteed.

RELIEVE YOUR BEATERS and INCREASE QUALITY  
and PRODUCTION. Write for full Particulars.

---

---

**Ryther & Pringle Company**  
Carthage, N.Y.



IMPROVED WARREN PATENT

# Double Drum Winder

With Slitter Attachment Combined

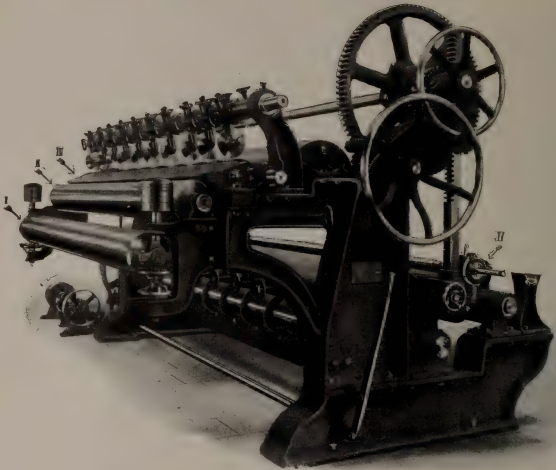

REAR VIEW SHOWING SLITTERS.

REFERENCE :

- I—8-inch Brass Spring Roll.
- II—8-inch Brass Carry Roll
- III—8-inch Adjustable Draw Board.
- IV—Adjustable Core Shaft Box.

Compare this Winder with Others

BUILT BY

## Ticonderoga Machine Works

TICONDEROGA, N.Y., U.S.A.

FARREL FOUNDRY AND MACHINE  
COMPANY

ANSONIA, CONN., - - U. S. A.

Largest Manufacturers in the world of

**CHILLED ROLLS**

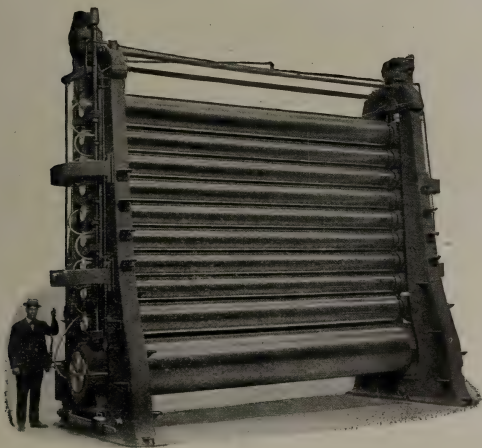

**CALENDERS**

*WITH PATENT HYDRAULIC LIFT*

**ROLL GRINDING MACHINES**

---

---

Would YOU like to enlarge your Business and find new Customers in all parts of the world? If so, ADVERTISE in

# “THE PAPER-MAKER AND BRITISH PAPER TRADE JOURNAL.”

THE LEADING AND MOST POPULAR TRADE ORGAN.

THE ADVERTISER  GOOD FOR  THE READER

We recently received the following letter:—

“We have hesitated over the matter, as we are at present so busy as to regard further advertising as almost superfluous.

“On the whole, however, we find it pays us better to have to refuse orders than to hunt after them, and will ask you therefore to insert our advertisement on same terms as last.

“We enclose herewith amended matter for advertisement, and shall be glad to have proof of same at your early convenience.”

We are constantly in the receipt of gratifying letters relative to the usefulness of our Journal, and we have pleasure in printing the following:

“Gentlemen,

We beg to advise that we have not as yet received the June number of ‘THE PAPER-MAKER AND BRITISH PAPER TRADE JOURNAL.’

We like the publication so well that we should be very sorry indeed to miss a copy of it.

Thanking you in advance for your kind attention,

We are, dear Sirs, yours very truly,  
F. R. KEYES & SON.  
20 Broad Street, New York.”

## S. C. PHILLIPS & Co.'s STANDARD PUBLICATIONS

### The Paper-Maker

AND BRITISH PAPER TRADE JOURNAL.

Published on the 1st of each month. Price 1s., by post 1s. 6d. Annual Subscription 12s. 6d. post free.

**The Stationery World,  
Printing and Allied Trades,  
AND FANCY GOODS REVIEW.**

Published on the 25th of each month. Price 6d. by post 7½d. Annual Subscription 5s. post free.

Chief Offices:

47 CANNON STREET, LONDON, E.C. (ENGLAND).

### The Paper Box and Bag Maker.

Published on the 19th of each month. Price 6d., by post 7½d. Annual Subscription 6s. 6d. post free.

**Phillips' Paper Trade Directory  
of the World.**

15s. 6d., post free to all countries.

NEW EDITION FOR 1911 NOW READY.

Specimen Copies and Advertisement Rates  
FREE OF APPLICATION.

We are now rapidly compiling the new  
edition of the

# Canadian Pulp and Paper Directory

This Directory will contain Complete Lists of Pulp and Paper Mills, giving capacity, machinery, etc.; Wholesale Paper and Stationery Dealers; Printers and Publishers; Lithographers, Bookbinders and Rulers; Manufacturers of Stationery, Paper Bags, Boxes, etc.; also Retail Stationers and Booksellers of Canada.

ADVERTISING RATES	}	1 Page, \$25	} Each advertiser receives a copy of the book.
		1/2 " 15	
		1/4 " 8	

If ordered in advance, \$2 per copy

After publication, \$3

Send in your order now.

**BIGGAR - WILSON, LIMITED**  
TORONTO, CANADA

**UNDER MANAGER.**—Young man, 14 years' practical experience in English mill making long elephants, news, all-wood printings, cream laid, etc. Experienced mill chemist—testing of papers, fibres, etc. Highest references. Address H. C., c/o Pulp and Paper Magazine.

**WANTED.**—Superintendent for a new 150-ton ground wood mill. One with technical education preferred. Please state education and experience in full; also give age, if married or single, and salary asked for. Address Box 27, care Pulp and Paper Magazine, Toronto.

As we are using all our Water Power at our Pulp Mill for electricity, we are disposing of the Pulp Mill Machinery—including Millard Patent Grinders which were in use only a few months and are absolutely as good as new, also Wet Machines, Barkers, Screens, Pumps, Piping, Shafting, Stones, etc., etc., all in good condition. Full information will be given upon application.

Apply Box "A,"

Pulp and Paper Magazine,  
Toronto.

**FOR SALE.**

A 92-inch Fourdrinier machine, complete, now running in Canadian mill, to make room for a larger machine.

For particulars, etc., address Box 25, Pulp and Paper Magazine.

**PAPER MILL ENGINEER.**—Technical graduate, ten years' experience, now consulting engineer for one of the largest paper mills in United States, wants change. Open for engagement in near future. Will give part or whole time. Apply Box 26, Pulp and Paper Magazine, Toronto.

**A GENTLEMAN** from Scotland, resident in Toronto, having had practical experience in all departments of paper making, would like to hear from firms to whom his services might be of use. He has had wide and varied experience "on the road" in the printing and stationery trades, also the manufacture of paper bags. Box (S.W.) Pulp & Paper Magazine.

—Mr. T. L. Crossley, the Montreal expert in the manufacture of wood pulp, recently gave before the McGill Science Undergraduate Society, a popular, but very interesting address on that subject, illustrated by some good lantern slides.

**GEWERKSCHAFT SACTLEBEN**

**Homburg-Niederrhein**  
**GERMANY**

Largest Makers  
of all Qualities

**Blanc Fixe**

**Bright**

**Matt or Dull**

**Photographic**

Three  
Varieties



**SCOTT'S IMPROVED RECOVERY SYSTEMS**  
**FOR**  
**SODA, SULPHATE AND SULPHITE**  
**SPENT LIQUORS GIVE THE**  
**MAXIMUM ECONOMY AND EFFICIENCY**

*The* **PRINCIPLE**  
*The* **DESIGN**  
*The* **CONSTRUCTION** } **IS RIGHT**  
*The* **OPERATION**  
*The* **RESULT**

Complete Installations made by "THE FIRM WITH THE EXPERIENCE"

**ERNEST SCOTT & CO. MANUFACTURING ENGINEERS**  
**FALL RIVER, MASS. and MONTREAL, P.Q.**

**SODA OR SULPHATE**

**RECOVERY SYSTEM**  
**MAXIMUM EFFICIENCY                      MINIMUM LOSSES**

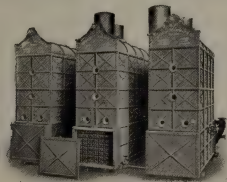

**WELDED DIGESTERS      MULTIPLE EFFECT EVAPORATORS**  
**AND OTHER PULP MILL EQUIPMENT**

**SWENSON EVAPORATOR CO.**

945 Monadnock Bldg. . . . . CHICAGO

---



---

# CHR. WANDEL REUTLINGEN GERMANY

---

ESTABLISHED 1869.

Manufacturer of the

## **"ORIGINAL WANDEL" Rotary Sulphite Pulp Screen**

---

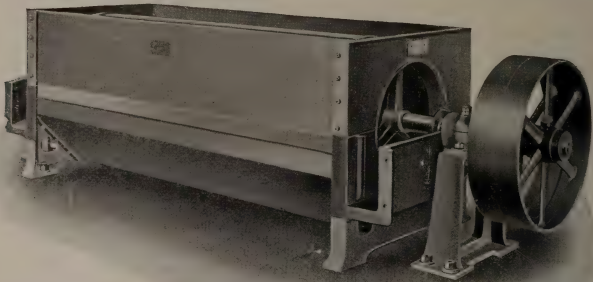

---



---

Satisfactory service sure. Best by test. Beware of imitations.

Largest screening surface, combined with small requirement of room. Absolutely reliable and noiseless work.

No contact of the pulp with iron parts. Simple, durable, perfect. Price very moderate.

The system now adopted by the most important Sulphite Fibre Mills of Europe.

Prices and further particulars gladly furnished.

---



---

**Agent for Canada :**

## **W. G. ASHDOWN**

**1649 Mance Street**

**MONTREAL**

---



---

HIGH GRADE  
**"VICTORIA" TURBO PUMPS**

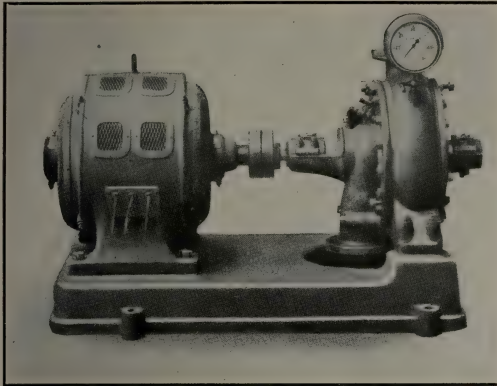

---

---

Suitable  
for all conditions. Water,  
pulp, caustic  
or acid. High-  
est efficiency  
Flat charac-  
teristic curve.  
Unrivalled  
workmanship.

---

---

**THE CANADIAN BOVING COMPANY, LTD.**  
164 BAY STREET : : : : TORONTO

# A GOOD JORDAN ENGINE

BUILT IN 3 SIZES

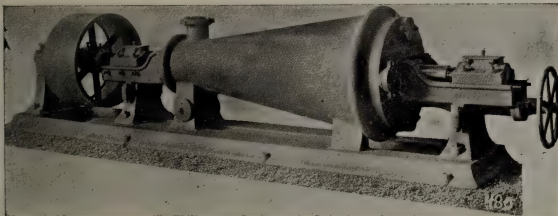

**THE BLACK-CLAWSON CO.**  
HAMILTON, OHIO, U.S.A.

Builders of **PAPER MAKING MACHINES** and machinery  
for Paper and Pulp Mills. Our machines are completely erected in shop  
on cast iron levelling plates and carefully inspected before shipment.

*Write for Catalogue.*

**OPENINGS IN CUBA.**

(Continued from Page xxxii.)

hand, on examination of the imports it can be seen how other nations such as Great Britain, Spain, France and Germany, who are in exactly the same footing in regard to the United States as Canada, have reaped good results from this market.

Even a hasty study reveals how dependent Cuba is upon the outside world. In food stuffs she purchased to the amount of \$16,073,473 from the United States, and \$19,211,078 from the rest of the world in the fiscal year of 1908; this meaning that American corn, flour and other cereals were more than offset by Indian rice and Canadian flour; that her codfish came from Canada and Spain; that while the bulk of her meat came from the United States, Europe more than out-sold the United States in milk, cream, cheese and other light products; that the oils and wines came from Europe; that Canada sold more potatoes and Spain more onions, and Mexico more beans, than the United States; and France, Germany, Spain, South America and other countries contributed nearly twice as much of other food stuffs. In the matter of textiles, the United States contributed only to an extent of \$1,528,183, while the rest of the world (principally England, through its cotton goods), sold \$14,358,898 worth . . .

This should be an incentive for Canada to use her best efforts to augment her trade with Cuba. The Canadian Trade Agent in Havana is in an excellent position to assist Canadian

merchants to establish relations with local firms; and if Canadian exporters comply with the requirements, and conditions so clearly given in the foregoing excerpt, there is no doubt but that Canada could advantageously compete, not only with European countries, but with the United States as well.

**BRITISH MARKETS.**

The World's Paper Trade Review reports the situation in the pulp and chemical markets as follows:—

No change is reported in market conditions for mechanical wood pulps. In view of diminishing stocks, makers are holding such small quantities as they have unsold for an expected rise in prices. Buyers, however, seem fairly well covered for the first half of the year.

The position of chemical pulps continues very firm; sellers seem disinclined to make concessions, and business is rather restricted.

For this season of the year the market for chemicals is firm, and the demand is good. Prices of soda crystals are expected to be reduced from the beginning of next year, but no figures are yet available. Ammonia alkali, 58 per cent., is quoted £4 5s. to £4 10s. f.o.b. Liverpool; bleaching powder, £4 15s. per ton, f.o.b. Manchester; caustic soda (high-strength), £10 2s. 6d.; soda crystals, £2 12s. 6d.; and salt cake, £2 2s. 6d.

For home rags the trade has fallen off a little, while foreign rags continue steady in price.

**TOWNSEND****ELECTROLYTIC CELL**

2,500-5000 AMPERE UNITS. ALKALI AND CHLORINE.  
CAUSTIC SODA. BLEACHING POWDER. CHLORINE  
FOR ORES. LICENSES GRANTED. CANADIAN PATENTS  
91939 - 105088 - 105089.

**HOOKER ELECTROCHEMICAL COMPANY**  
40 WALL STREET, NEW YORK

Telephone: 2726 BROAD.

Cable Address: "LAGERLÖF NEWYORK."

# Scandinavian-American Trading Company,

PRODUCE EXCHANGE BUILDING, NEW YORK,

IMPORTERS AND EXPORTERS OF

FOREIGN AND DOMESTIC

# WOOD PULP

OF ALL KINDS

AND

# PAPER MILL SUPPLIES.

HANS LAGERLÖF, PRES.



# CROOKES, ROBERTS & CO.

SHEFFIELD : : : ENGLAND

Makers of  
Crucible Cast Steel  
Bed Plates  
Jordan Fillings  
Beater Bars



Makers of  
Bessemer Cast Steel  
Crookes'  
Composition  
Fillings

And every description of Cutter Knives, Tools and Steel used and required in Paper Mills.

**ARGUS** High-Speed **STEEL** for fine machine tools is unsurpassed.

Once Used - Always Used

YOU SAVE MONEY USING "ARGUS" GOODS

WRITE US  
**ARTHUR P. TIPPET & CO.**  
Agents for Canada MONTREAL

## SPENCER'S

ALWAYS



RELIABLE

Best Wool - Best Weave - Best Wear

**J H. SPENCER & SONS**  
BURY - - - ENGLAND

Canadian Agents: **ARTHUR P. TIPPET & CO., MONTREAL**

# INDEX TO ADVERTISEMENTS.

(SEE CLASSIFIED ADVERTISERS INDEX ON PAGE XXVI.)

Ambursen Hydraulic Construction Co.....	lxv	Farrel Foundry & Machinery Co.....	xxxvii
Anderson, F. C.....	lvii	Fibre Development Co., The.....	lviii
Appleton Machine Co.....	v	Finckh, Hermann.....	xxxiii
Ashdown, W. G.....	xli		
Atterbury Bros. Inc.....	lxi	Garland, M. Co.....	xii
		General Supply Co. of Canada, Ltd.....	lv
Baker & Shevlin Co.....	vii	Gewerkschaft Sachtleben.....	xl
Becker & Co.....	xxix	Gillespie, Geo. H. Co.....	lxv
Beloit Iron Works.....	xliii	Glens Falls Machine Works.....	lv
Bentley & Jackson.....	viii	Green Bay Barker Co.....	xxi
Bertram, James & Son., Ltd.....	xix		
Bertram's, Limited.....	xlx	Hamelin, The, & Ayers Co., Ltd.....	lx
Black-Clawson Co., The.....	xliii	Hardy, Geo. F.....	lviii
Blethen, Hugh R.....	lix	Harmon Machine Co.....	v
Bredt & Co., F.....	li	Hay Knife Co., Peter, Limited.....	lxi
Brunner, Mond & Co., Limited.....	lxvi	Holyoke Machine Co.....	xvi
		Hooker Electrochemical Co.....	xliv
Canada Coating Mills, Limited.....	lvii	Hough, R.....	lxvi
Canada Paper Co., Ltd.....	lvii	Howell Co., The.....	xlviii
Canadian Bומר & Boschert Press Co.....	lx		
Canadian Boving Co.....	xliii	International Process Co.....	li
Carthage Machine Co.....	xxiv		
Castle, Gottheil & Overton.....	li	Jeffrey Mfg. Co.....	liii
Chicoutimi Pulp Co.....	xxix	Jencks Machine Co.....	xvii
China Clay Co.....	l	Johnson & Sons, Limited, C. H.....	xlix
Christie, J. Co.....	lxvi	Jones, E. D. & Sons Co.....	xxvii
Christie, Limited, George.....	lxv		
Crookes, Roberts & Co.....	xlvi	Kimball, Herbert S.....	lix
		Klipstein & Co., A.....	l
Dallyn, Jardine & Co.....	li		
Dayton Globe Iron Works, Co.,.....	xxx	Lawrence Pump & Engine Co.....	li
Dean, F. W.....	lviii	Lea, R. S. & H. S. Ferguson.....	lviii
DeCew, J. A.....	lix	Little, Arthur D. Inc.....	lviii
Dillon Machine Co.....	xiv	Lyford, C. A. & Co.....	lviii
Dobler & Mudge.....	vi		
Dodge Mfg. Co.....	iv	Mallandain, Albert E.....	xxxiii
Dominion Belting Co.....	xlviii	Marx, J. & Co.....	v
Douglas, J. M. & Co.....	lxv	McDougall, John, Caledonian Iron Works Co., Limited.....	liiii
		Milne, Jas., and Son.....	xx
Eaton & Brownell.....	lviii	Moore & White Co.....	xv
Eastern Pipe and Construction Co., The.....	l		
Emerson Mfg. Co.....	xxv		

## HYDRAULIC TURBINES

One unit of six with a total capacity of 13,100 Horse Power furnished for the new plant of J. R. Booth, Ottawa, Ontario. We build Turbines for any power for heads from 3 to 600 feet.

WRITE FOR CATALOGUE



**S. MORGAN SMITH CO.,**  
YORK - - PA.

New Brunswick Pulp and Paper Co., Limited.....	lvi	Spencer, J. H. & Sons.....	xlvi
Northern Engineering Works.....	lxvi	Stebbins Engineering & Mfg. Co.....	lix
Northern Mills Co.....	lvi	Swezey, R. O.....	lix
Panzl Digester Lining Co.....	lvi	Swenson Evaporator Co.....	xli
Paper Makers Chemical Co.....	lxi	Ticonderoga Machine Works.....	xxxvi
Parsons Trading Co.....	xxiv	Tippett, Arthur & Co.....	xxv
Penman's Limited.....	li	Union Screen Plate Co.....	liii
Perkins, B. P. & Son.....	xxxv	Union Sulphur Co., The.....	lxi
Phillips, S. C. & Co.....	xxxviii	United Wire Works, Limited.....	xxv
Porritt & Son, Joseph.....	xl	Valley Iron Works.....	xxxii
Porritt Bros. & Austin.....	xlx	Vera Chemical Co.....	lxii
Prather, H. B.....	xlx	Voith, J. M.....	x
Preston's Digester Lining Co., Limited.....	xxxv	Walker, J. R. & Co.....	lxii
Pringle, T. & Sons.....	lviii	Wallace, Jos. H. & Co.....	lix
Pullan, E.....	liv	Walmsley, Charles & Co.....	xxii-xxiii
Pulp & Paper Trading Co., The.....	lxi	Wandel, Chr.....	xlii
Reddaway, F. & Co.....	liv	Wandel Screen Mfg. Co.....	lx
Rice, Barton & Fales.....	ii	Waterous Engine Works Co., Limited.....	lxiv
Riordon Paper Co., Limited.....	lvii	Wertheim & Co., A.....	lxiii
Ryther & Pringle.....	xxxv	Westbye, P. P.....	xi-xxxiii
Sadler & Haworth.....	xxviii	Wilson, Paterson & Co.....	xxv
Sandy Hill Iron & Brass Works.....	vii	Winn & Holland.....	lxvi
Scandinavian American Trading Co.....	xlv	Woolford, G. Wood Tank Mfg. Co.....	lxii
Scott, Ernest & Co.....	xli	Zaremba Co.....	liv
Sherbrooke Machinery Co., Limited.....	xviii		
Smart-Turner Machine Co.....	lxvi		
Smith, S. Morgan.....	xlvii		
Snell, Samuel Co.....	l		

## KRAFT PULP



MADE IN SWEDEN

The best Pulp for making

KRAFT BROWN PAPER

Sole Selling Agents, United States  
and Canada

**THE HOWELL CO.**

8-10 Wellington St., East

TORONTO - CAN.

  
**MAPLE LEAF**  
**STITCHED COTTON DUCK**  
**BELTING**  
**DOMINION BELTING CO. LTD.**  
**HAMILTON CANADA**

**HAVE YOU GOT YOUR COPY OF THE  
PAPER MAKERS' POCKET BOOK ?**

**SEE PAGE 54**

# BERTRAMS, LIMITED

## Papermakers' Engineers

St. Katherine's Works,  
SCIENNES, EDINBURGH.

The Newest and most Up-to-Date Machinery for Papermakers,  
embracing British, American and Continental Improvements.

The J. L. MORRISON CO., Agents in Canada,  
445-447 King Street West, TORONTO

---

C. H. JOHNSON & SONS, Ltd.

WIRE WORKS, — ST. HENRY, — MONTREAL.

MANUFACTURERS OF

Fourdrinier Wires, Cylinder Wires,  
Brass, Copper and Iron Wire Cloth, Dandy Rolls

---

# PORRITT BRO<sup>R</sup>. & AUSTIN

Stubbins Vale Mills—RAMSBOTTOM—near Manchester, England.

Manufacturers of every description of

**Felts and Jackets for  
Pulp and Paper Mills.**

Agents for Canada: C. H. JOHNSON & Sons, Ltd., ST. HENRY, MONTREAL.

**We Manufacture** Wooden Water Pipe for Water Works Systems. Specially  
 Made Pipe for conveying Chemicals. Continuous Stave  
 Pipe for Power Plants. Sizes from 2' to 12' Diameter

**The Eastern Pipe and Construction Co.,**  
 Alexandria, Box 329 Ontario.

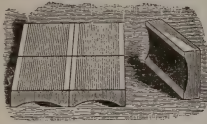

### Use Snell's Drainer Bottoms

They drain quickly and don't let the Pulp go into  
 River. No Dust. No Splinters. Clean Stock.

*Send for Sample and Price.*

**Samuel Snell Co., - Holyoke, Mass.**

Cable Address:—"Kaolin, Manchester." A.B.C. Codes 4th & 5th Edition

# CHINA CLAY CO.

JOHN WILLIAMSON, Manager.

4 St. Anne's Square

**MANCHESTER, ENG.**

MINES—Ruddle, Bojea, Colchester, South Ninestones, Tronance, St. Austen  
 Cornwall.

CONTRACTORS TO H.M. INDIAN GOVERNMENT

Canadian Representatives—C. A. Meincke & Co., 222 Coristine Bldg., Montreal.

## A. KLIPSTEIN & Co. Ltd.

(OF CANADA)

12 ST. PETER ST. - - MONTREAL

# SULPHATE ALUMINA

CHINA CLAY, BLEACH and CASEIN  
 PAPER BLUE, both Basic and Acid  
 AURAMINE - RHODAMINE

and all other Aniline Colors

Shades Carefully Matched in our Laboratory      Mention Pulp & Paper  
 Magazine

New York Office - 129 Pearl Street



## LAWRENCE PUMP AND ENGINE CO.

P. O. BOX 70, DEPT. 10  
LAWRENCE :: MASS.

### CENTRIFUGAL PUMPS

We make an exclusive specialty of High Efficiency Centrifugal Pumps for Paper and Pulp Mill. In one mill 49 of our Pumps are running, the customer writes— "Your Pumps are all giving perfect satisfaction."



ESTABLISHED 1808.

REGISTERED.

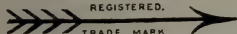

## FELTS For Pulp and Paper Mills.

### JOSEPH PORRITT & SONS

Agents for  
Canada  
and United  
States.

HELMSHORE

Manchester, England.

All kinds  
Woollen, Lin-  
en and Cotton  
Cloths for  
Mechanical  
Purposes.

F. BREDT & CO., 240 Water Street, NEW YORK.

## PENMANS LIMITED

ST. HYACINTHE, QUEBEC

Manufacturers of

PULP AND PAPER MAKERS' FELTS,  
JACKETS, STRAINER CLOTHS, ETC.

Special sizes and qualities made to order. Satisfaction guaranteed.

DALLYN, JARDINE & CO. TORONTO Selling Agents

## CASTLE, GOTTHEIL & OVERTON

200 Fifth Avenue, New York

AGENTS FOR

### **Sulphite and Wood Pulp Mills**

Dealers in all kinds of Paperstock, Sizing, etc.

Correspondence Solicited.

THE PROCESSES AND APPARATUS  
THAT MADE "KRAFT PAPER'S" SUCCESSFUL



CABLE ADDRESSES  
KRAFTLICH, NEW YORK.  
INPROKRAFT, LONDON.

# INTERNATIONAL PAPER COMPANY

EUROPEAN OFFICES  
SALISBURY HOUSE,  
LONDON, ENGLAND.

AMERICAN OFFICES  
5 BEEKMAN STREET  
NEW YORK, N.Y.

SOLE AGENTS IN NORTH AMERICA  
FOR  
CARL P. CARLSON, SWEDEN.  
EVAPORATORS AND LIQUOR SYSTEMS.

JULIUS PINTSCH, ACTIENGESELLSCHAFT, GERMANY.  
DIGESTERS, DIFFUSERS AND SPECIALTIES.

SWEDISH SYSTEM OF RECOVERY FOR  
TURPENTINE, ALCOHOL AND OTHER BY-PRODUCTS.

ENGINEERS, CHEMISTS, PULP EXPERTS.

# TURBINE PUMPS

SPECIALLY DESIGNED TO SUIT  
THE CONDITIONS OF OPERATION

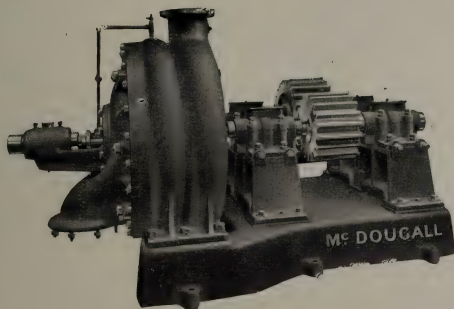

THIS SIX INCH TURBINE PUMP, GEARED TO A WATER  
WHEEL, *CHICOUTIMI PULP COMPANY*, HAS A  
CAPACITY OF 833 IMPERIAL GALLONS  
PER MINUTE, AGAINST A  
FIRE PRESSURE  
OF 100 LBS.

---

Works: 512 William Street, Montreal

---

THE JOHN McDOUGALL,  
CALEDONIAN IRON WORKS CO.,  
LIMITED

Nearly FIFTY YEARS ago we introduced this Belt. IT HAS STOOD THE TEST OF TIME  
2" to 24" in stock

Every Belt is  
Stamped with  
Trade-Mark.



Write or phone us

Beware  
of Imitations

SOLE MAKERS

F. REDDAWAY & CO.,

MONTREAL, CANADA.

**E. PULLAN,** 490 Adelaide St. W.,  
TORONTO

Largest Paper Stock Dealer in Canada

**RAGS AND PAPER STOCK GRADED TO SUIT MILL REQUIREMENTS**

Correspondence Solicited.

## EVAPORATORS

Zaremba Patent Multiple Effects

FOR RECOVERY OF

# SULPHATE OR SODA

*"Not the excellence of yesterday, but the excellence of to-day"*

ZAREMBA COMPANY

Buffalo, U.S.A.

SECOND AND ENLARGED EDITION

# THE PAPERMAKERS' POCKET BOOK

Specially Compiled for

PAPER MILL OPERATIVES, ENGINEERS, CHEMISTS,  
AND OFFICIALS

By JAMES BEVERIDGE

- ☞ This new edition contains more exhaustive chapters on Raw Fibrous Stock, such as Cotton and Linen Rags, Esparto, Bamboo, Megass or Crushed Sugar Cane, etc.
- ☞ The chapter on Wood Cellulose Manufacture by the Soda, Sulphate, and Sulphite methods has been amplified. Very complete information has been given of Soda Recovery, Causticising and Composition of Recovered Soda Liquors.
- ☞ A new but brief chapter has been added relating to Loading Materials.
- ☞ The chapter on Chemical Analysis has been enlarged.
- ☞ It will be found that the additional matter is given in concise form, is of a highly practical nature, and is not generally found in English text books.

PRICE, \$3.50

**BIGGAR-WILSON, LTD., TORONTO**

# VI-BALATA BELTING

Is made in all widths up to 50 inches, and in any thickness from 3 ply to 24 ply. Is absolutely waterproof and not affected by extremes of temperature. Has great strength and durability, and is practically stretchless.

A recent test made by the well-known Testing Engineers, Messrs. Kirkaldy & Sons, London, Eng., gives the following result:

**6-inch 4-ply broke at 13,000 lbs.**

OR

**9,000 lbs. per square inch**

**LARGE STOCKS CARRIED AT ALL BRANCHES**

---

---

SOLE AGENTS:

**THE GENERAL SUPPLY CO.,**  
OF CANADA, LTD.

**356-58-60 SPARKS ST., - OTTAWA, ONT.**

115-125 Adelaide Street West, TORONTO

WOODS WESTERN BUILDING, Cor. Market & Louise Sts., WINNIPEG MAN.

FLECK BROS., LTD., 443 Pender St. West, VANCOUVER, B.C.



## THE NORTHERN MILLS COMPANY

**Paper Manufacturers. Printing and Writing Papers.**

Super-Calendered, Velvet and Machine Finished Book, Litho and Antique Printing, Engine Sized Writing and Envelope Papers, White and Tinted Bond. Typewriter Papers (Glazed and Rough Finish). Writing Tablets and Envelopes.

Ask for "Canadian Bond," "Provincial Bond," "Adelia," and "Northern Mills."

**Head Office:**  
Montreal, 278 St. Paul Street.

**Mills:**  
St. Adele, Que.

## Genuine "KRAFT" Papers MADE IN CANADA

**THE NEW BRUNSWICK PULP & PAPER CO., LTD.**

**Springfield Mills, Millerton, N.B.**

TORONTO, 145 Wellington St. W.

MONTREAL, 404 St. Nicholas Bldg.

## PANZL'S PATENTED LINING COMPOSITION

IS THE SAFEST AND BEST MATERIAL FOR

**LINING OF SULPHITE PULP DIGESTERS**

AND ACID RECLAIMING TANKS

**PANZL LININGS ARE SAFEST AND  
MOST DURABLE**

They are really acid-proof and practically indestructible.

All Digesters lined with Panzl's patented composition, new as tight and in as good condition after years of continuous use as they ever were, no leaks and no repairs.

Panzl Linings can be made considerably thinner than the other linings, thus increasing the capacity of the digesters.

The composition and the system of constructing of Panzl Linings are patented in all countries where wood pulp is being manufactured by the sulphite process. The PANZL U.S. Patents have been adjudicated to be valid in law and wholly independent of all prior patents relating to linings of digesters.

For information and estimates, address:—

**PANZL DIGESTER LINING COMPANY**

**505 Washington Ave., Muskegon, Mich.**

## The Riordon Paper Company, Limited

Fibre, Paper, Lumber.

MONTREAL - CANADA

News Paper, Hanging Paper, Wrapping Paper, Building Paper, Celebrated "Impervious" Spruce Sheathing and Sulphite Fibre for all kinds of Paper.

## THE CANADA COATING MILLS, Ltd.

GEORGETOWN, ONT.



Manufacturers of  
SURFACE COATED BOOK and LITHOGRAPHIC  
PAPERS COATED CARDBOARD and COATED  
BOXBOARDS of every description.

### "Chalk White" Coated Book Paper.

The best and whitest coated paper sold.

**ALL REGULAR SIZES AND WEIGHTS IN STOCK.**

Our Art Litho Cover Paper is stocked in four tints, 2 sizes. 20 x 25 and 21½ x 28½. Samples gladly sent.

MONTREAL  
TORONTO

**CANADA PAPER Co.**  
LIMITED

WINDSOR  
MILLS, P.Q.

# DIRECTORY

of

## Civil and Chemical Engineers

### T. PRINGLE & SON, Limited

Engineers and Architects

Plans and Specifications for Pulp and Paper Mills, Power Plants and other Industrial Works.

Bell Telephone: Main 3890.  
Cable Address: "Pringleston."

Coristine Bldg. - - - Montreal

### R. S. LEA, and H. S. FERGUSON, ENGINEERS

Pulp, Paper and Chemical Fibre Mills.  
Water Power Development and Trans-  
mission. Steam Power Plants.

Telephone Long Distance Up. 751.  
405 DORCHESTER ST. West, MONTREAL

### Arthur D. Little Inc.

— LABORATORY OF —  
ENGINEERING CHEMISTRY

93 BROAD ST., BOSTON, - MASS.

Our staff includes experts in Papermaking Chemistry  
—Sulphite Mill Practice—Fuel Engineering.

### GEORGE F. HARDY, M. AM. SOC., M.E. M. CAN. SOC. C.E.

Consulting Engineer.

Paper, Pulp and Fibre Mills, Examination of  
Mill Properties, Water Power Developments.

Mutual Reserve Building, - 309 Broadway,  
NEW YORK.

CHARLES E. EATON, JAMES P. BROWNELL,  
M. Am. Soc., M. E. C. E.

### EATON & BROWNELL, Consulting Engineers and Architects.

Paper, Pulp and Fibre Mills, Water, Steam and  
Electric Power Development, Examination of  
Properties, Consultation Reports.

SMITH BLDG. WATERTOWN, N. Y.

### F. W. DEAN, Mill Engineer and Architect

(Formerly of Dean & Main)

Exchange Building 53 State Street,  
BOSTON, Mass.

Paper and Pulp Mills. Steam, Hydraulic and  
Electrical Developments. Examinations and Reports  
of Projects.

ENGINEERS SHOULD WRITE  
THE PUBLISHERS FOR RATE  
OF CARDS ON THIS PAGE.

### THE FIBRE DEVELOPMENT CO.

APPLETON, WIS., U.S.A.  
Engineers

WATER POWERS STEAM AND ELECTRIC PLANTS  
PULP AND PAPER MILLS.

### FRED. C. ANDERSON

Mill Engineer

20 years practical experience in paper, ground  
wood and chemical pulp making. Steam  
Hydraulic and Electrical development,  
Examinations and Reports on both  
old properties and new projects.

9-10 Strickland Bldg., CARTHAGE N. Y.

### FOREST ENGINEERS

FOREST SURVEYS LOGGING MAPS  
WATER POWER TIMBER ESTIMATES WATER STORAGE

We are prepared to examine and report on Forest  
Properties anywhere.

CLARK & LYFORD LYFORD, CLARK & LYFORD  
403 Crown Bldg. 206 Board of Trade Bldg.  
Vancouver, Montreal.

**PULP  
PAPER  
POWER** JOSEPH H. WALLACE & CO.  
INDUSTRIAL ENGINEERS.  
TEMPLE COURT BLDG. NEW YORK.  
SALISBURY HOUSE, LONDON, E.C.  
CABLES, TRIPLEX, N. Y., TRIPLEXIS, LONDON.

**J. A. De CEW**

M.A. INST. CHEM. ENG.  
A.M. CAN. SOC. C.E.

Paper Mill Analysis.

Pulp Testing

Investigations.

**Chemical  
Engineer**

Sulphite Fibre

Soda Fibre

Reports

**Canadian Express Building MONTREAL.**

HERBERT S. KIMBALL, S.B., M. Am. Soc. C.E.  
Chemical Engineer and Mill Architect.

R. O. SWEEZEY, B.Sc., A.M. Can. Soc. C.E.  
Civil and Forestry Engineer.

**Chemical and Mechanical Pulp & Paper Mill Engineers**

Canadian Timber Lands and Waterpower Development  
Consultations solicited on Canadian exploitation.

**Metropolitan Building, QUEBEC, Canada.**

Power, Lighting, Heating, Ventilating and Drying.—Complete New Plants, Improvement of Old Plants;  
Plans, Specifications, Contracts, Estimates, Tests, Appraisals, Inspections and Reports.—Pulp, Paper,  
Box Board and Coating Mills.

Lowest

Possible

Operating Cost.

**H. B. PRATHER,**

**CONSULTING ENGINEER,**

**ROCKFELLER BLDG., CLEVELAND, O.**

Guaranteed

Results.

**HUGH R. BLETHEN**

**21 PARK ROW, - - - NEW YORK, N.Y.**

Traveling Cranes - Overhead Tramways - Trolleys and Chain  
Hoists for Paper and Pulp Mills - Power Houses.

**Stebbins Engineering & Mfg. Co.**  
**WATERTOWN, N.Y.**

MANUFACTURERS OF

STEBBINS' ACID SYSTEMS, SULPHUR BURNER  
DIGESTER LININGS, RECLAIMERS, ETC.

Engineering Department  
under

Mr. T. L. TOMLINES

Plans, Estimates and Specifications for Paper,  
Pulp and Fibre Mills,

Water Power and Hydro-Electric Developments

NEW EDITION FOR 1911 NOW READY

*Printed in Clear Type***The Paper***Alphabetically Arranged***Makers' Directory of all Nations****Annuaire de la Papeterie de Toutes les Nations.****Internationales Adressbuch sämtlicher Papier fabrikanten der Welt.**

## —CONTENTS INCLUDE—

Paper, Pulp, and Board Mills. Names and Addresses of more than 5,000 in 40 different Countries, with (1) Makes of Paper; (2) Number and width of Machines; (3) Tonnage Output; (4) Power Used; (5) Telegraphic Addresses; (6) Agents, etc. Classified Lists of Principal Productions for each country.

Special Buyers' Guide.  
Paper Agents and Mill Representatives (with Mills Represented).  
Paper Stainers, Enamellers on Surfacers of Paper.

Wholesale Stationers and Paper Merchants.

Waste Paper Merchants and Rag Merchants & Paper Stock Dealers.

Export Merchants Shippers of Paper.

Cardboard and Paper Box Manufacturers.

China Clay Merchants.

Paper Bag Makers.

Buyers' Guide.

Sizes (with folds) of British Papers.

Paper Trade Customs, Paper Equivalents. &c., &c.

British Paper Trade Customs.

Price 10/6 net, or Post Free 11/6.

TO BE OBTAINED FROM

**DEAN & SON, LTD., 160a Fleet St.,  
London, E.C.**

THE RED BOOK OF THE  
BRITISH PAPER  
INDUSTRY.



Demy 8vo, Cloth Bound  
775 Pages.

**PULP · PRESSES**

AND ACCESSORIES

**CANADIAN BOOMER & BOSCHERT PRESS Co., Ltd.**

18 TANSLEY STREET, MONTREAL

"LACHUTE FELTS"

Bell Tel. No. 23

**The Hamelin & Ayers Co., Limited****LACHUTE MILLS, P.Q.**

MANUFACTURERS OF EVERY DESCRIPTION OF

**FELTS** FOR PAPER AND PULP MILLS**"The Best are the Cheapest."**



**BARKER  
CHIPPER  
PAPER-CUTTER**

**MACHINE** *Of Every*  
**KNIVES** *Description*

**THE PETER HAY KNIFE CO., LIMITED, GALT, ONT.**

**The PULP & PAPER TRADING CO.**

TEMPLE COURT BUILDING, NEW YORK CITY.  
DEALERS IN

**Paper and Pulp of All Kinds.**

Prices and Samples on Application.

REGISTERED



JOHN KNIGHT, Pres. C. K. WILLIAMS, Treas. C. H. KNIGHT, Sec.

**Paper-Makers Chemical Co.**

FROM MINE TO MILL

**ENGLISH CHINA CLAYS  
MANUFACTURERS**

**Excelsior Felt Cleaner**

GBB Brand China Clay is  
a natural pure white, no artificial tinting  
Unsurpassed for  
coating, bleaching, or fine papers.

Superior Rosin Size  
Superior Casein Size

**EASTON, PA., U.S.A.**

# **The Union Sulphur Company**

**Producers of the Highest Grade Brimstone on the Market**

Absolutely free from Arsenic, Selenium or Tellurium

**The Largest Sulphur Mine in the World**

**CALCASIEU PARISH, - LOUISIANA**

**Main Offices : 82 Beaver Street, NEW YORK**

## WE GUARANTEE OUR SIZINGS TO BE ABSOLUTELY CLEAN OUR VERA PAPER SIZE

is purest, strongest and highest free rosin size made. We can furnish you with an ideal rosin size and patented apparatus to use same.

### OUR VERA MILL SIZE

is the best soluble paper makers' rosin size made. Ready to use in cold or warm water in the ordinary way without apparatus. Gives better satisfaction and is more economical than mill made size.

Our sizings are cleaned by our new patented process and we guarantee this size to be absolutely clean, without the least speck of impurity in the same, preventing thereby black specks in the paper. We are shipping our size in barrels or tank-cars.

## VERA CHEMICAL COMPANY

Main Office and Western Factory  
NORTH MILWAUKEE, WIS.

Eastern Factory  
STONEHAM, MASS.

**J. R. Walker & Co.** Importers and Packers of **GRADED RAGS, PAPER STOCK  
ROPE BAGGING, ETC.**

WAREHOUSE, 35 COMMON ST., MONTREAL.

Also Manufacturers of Roofing and Building Papers. Leatherboard and Friction Board

Mills at Sault au Recollet, P.Q.

**ATTERBURY BROTHERS, Incorporated.**

*Importers and Exporters.*

**Wood Pulp,** FOREIGN AND DOMESTIC **Rags AND Paper Stock**

Potter Building, 145 Nassau Street, New York City.

Cable address "AFFECTIVE," New York.

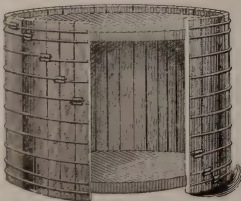

# WOOD TANKS

FOR PAPER MILLS,  
STUFF CHESTS,  
ACID TANKS,  
BLOW TANKS.

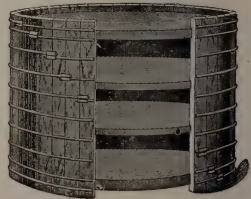

G. WOOLFORD WOOD TANK MFG. CO., 1429 CHESTNUT ST. PHILADELPHIA, PA.

# A. WERTHEIM & Co.

## HAMBURG

---

---

IMPORT AND EXPORT ALL KINDS OF

***Sulphite,  
Soda and  
Mechanical***

# WOOD PULPS

---

---

**OFFICES AT:**

CHRISTIANIA (Norway) .. Kirkegaden No. 20.  
GOTHENBURG (Sweden) .. Lilla Kyrkogatan No. 20.  
MANCHESTER .. .. Guardian Buildings (opposite Exchange).  
LONDON .. .. . 77a Queen Victoria Street, E.C.  
PARIS .. .. . Rue de Londres No. 29.  
ANGOULEME (France) .. 43 Rue Louis Desbrandes.  
LYONS .. .. . 54 Cours Gambetta.  
MILAN .. .. . 24 Via Solferino  
TOLOSA (Spain) .. .. 18 Calle San Francisco.  
NEW YORK .. .. . 99 Nassau Street.  
ST. PETERSBURG .. .. Little Podjasheskaja House, 4, Qu. 16.

---

---

**Telegraphic Address:**

**“WERTHEMO, HAMBURG.”**

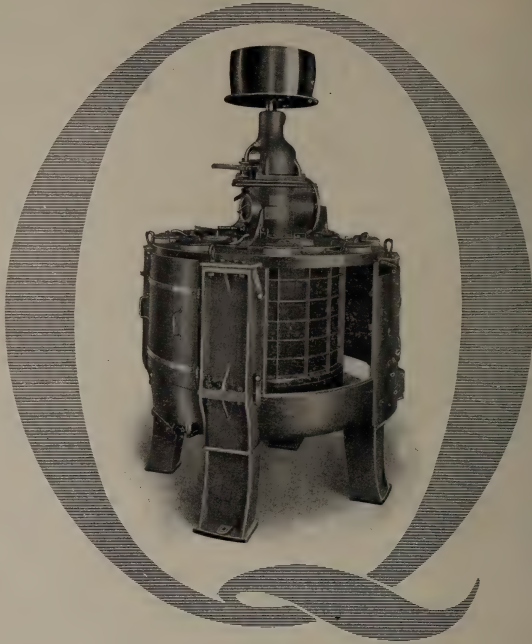

## Quiller Centrifugal Screens

*Horizontal and Vertical*

- ☐ We have the Canadian rights to build these machines—the most efficient, economical screening apparatus being manufactured. *More than 55 sold since April 1st.*
- ☐ Capacity of Horizontal type—24 to 28 tons of Ground Pulp per 24 hours. Capacity of Vertical type—12 tons Ground; 15 tons Sulphite Pulp per 24 hours.
- ☐ Less cost of up-keep, less power consumption with maximum production of best quality. Write for full particulars.

The Waterous Engine Works Co., Limited  
 Brantford, - Canada

**Geo. Christie Ltd.** - -

**Glasgow,  
Scotland**

**FOURDRINIER MACHINE WIRES**

Unequalled for Strength, Smoothness and Long Life.

**CYLINDER COVERS**

Canadian Agents:

**J. M. Douglas & Co., St. Nicholas St., Montreal.**

**CANADIAN TALC FILLER**

**GEO. H. GILLESPIE COMPANY**

**MADOC** - - -

**ONTARIO**

*The only Manufacturers of Paper Filler in Canada.*

Our Filler is used in Canada, United States, England, Germany, Austria, Holland, Russia and Scandinavia.

**AMBURSEN HYDRAULIC CONSTRUCTION CO.,**

**OF CANADA, LIMITED,**

**405 Dorchester St. W. - Montreal.**

(Associated with the Ambursen Hydraulic Construction Co., of Boston, Mass.)



**Concrete Steel Dam**

OF THE

**MISSISQUOI PULP CO.,**

**Sheldon Springs, Vt.**

Mid-channel, height 40 feet  
Total length 270 feet (only  
180 feet shows in the pic-  
ture, the remainder being  
concealed at the left.)

Dam specially designed to  
withstand heavy ice gorges.  
Factors of safety are calcu-  
lated for a 12-foot flood.

**IF YOU HAVE A DAM TO BUILD, WRITE US NOW.**



Every Grade of Waste for  
Paper Making.

# R. HOUGH,

LONDON, England.

Agent for Canada and U. S.,

**THE J. CHRISTIE CO.**

5 King St. West, TORONTO, Canada.

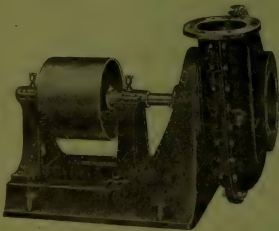

Steam and Power Pumps, Condensers, Travelling Cranes, etc. We also manufacture Triplex Stuff Pumps.

*The*  
**Smart-Turner Machine Co.**  
LIMITED  
Hamilton, - Canada

## Cranes and Hoists for Paper Mills and Power Plants

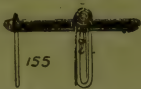

155



121C



158

NORTHERN ENGINEERING WORKS. 25 Chene Street - DETROIT, Mich.  
ADVANCE MACHINE WORKS, LTD., Manufacturers for Canada, Walkerville.

# WINN & HOLLAND, Limited

MONTREAL

PULP AND PAPER CHEMICALS. Sole Agents for:

**BRUNNER, MOND & CO'S.**

SODA ASH, BLEACHING POWDER,  
SAL SODA, CAUSTIC SODA, &c.

# PULP AND PAPER MAGAZINE OF CANADA

VOL. IV TORONTO, FEBRUARY, 1912. NO. 2

## PRINCIPAL CONTENTS

Ontario Government Paper  
Contracts.

The Tariff Commission.

Postal Rates on Periodicals Con-  
taining Samples of Paper.

Waste Sulphite Liquors.

Paper Yarn Textiles.

Wetting in Calendering.

Sulphite Tanning Liquors.

Canadian Forestry Association.

Paper Stretching.

Working up Paper Waste.

Chemical Processes in Manu-  
facture of Sulphate Pulp.

Established 1837

Incorporated 1867

# RICE, BARTON & FALES

## MACHINE & IRON CO.

CHARLES S. BARTON, Pres. & Treas.  
GEORGE S. BARTON, Secretary.

WORCESTER, MASS.

BUILDERS OF

**Modern Fast Running and Heavy Four-  
drinier and Cylinder Machines for Making  
Paper, and Drying Pulp.**

Double Drum Vertical Winders and Re-Winders.

Upright and Revolving Reels.

Large and Heavy Wet Machines.

Revolving Cutters and Layboys.

Hill Patent Diagonal Cutters, which can be equipped with  
Slitting Arrangement, and Reeling Off Bars.

Chilled Iron Calender Rolls.

Screens and Screen Plates.

Stuff, Suction and Fan Pumps.

Patent Top and Double Edged Slitters.

Pneumatic Re-Winders for Small Rolls.

Additions and Changes made to Old Paper Machines  
Greatly Increasing Speed and Capacity.

## **Sulphite Mill Specialties**

# Jeffrey Pulp Lap Shredders

in Mills save time, labor and power. Prepare dry, wet or frozen stock for mixing engines.

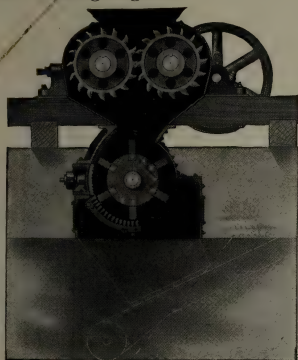

Guaranteed capacity, 10 tons (dry weight) per hour, when reducing wet, dry or pressed pulp. Guaranteed capacity, 6 tons (dry weight) per hour, when reducing frozen pulp.

Designers and builders of Elevating, Conveying and Power Transmission Machinery for all requirements in Pulp and Paper Mills.

Write for prices, capacities, etc.

## The Jeffrey Manufacturing Company

Canadian Works and Main Office :  
MONTREAL

2-12

Branch Office :  
WINNIPEG

E. J. WELCH, *President and Managing Director*  
HENRY W. S. DOWNS, *Superintendent*

EMMONS CROCKER, *Vice-President*  
A. S. MORSE, *Secretary and Treasurer*

# SCREEN PLATES



The "Union" Bronze (best phosphorized cast metal) Plates for Sulphite Mills. The Standard Rolled Brass Plates. The "Union" Cast Metal Suction Plates.

We carry a large stock of blanks of the various sizes in both metals and can fill all orders promptly.

Old plates reclosed and recut by our process are practically as good as new and give better results than by any other process.

## Union Screen Plate Co. of Canada, Limited

FACTORY : LENNOXVILLE, QUEBEC.

OFFICES : Lennoxville, Quebec, and Fitchburg, Massachusetts, U. S. A.

# Glens Falls Machine Works

GLENS FALLS, N.Y.



Sole Manufacturers of

**Tromblee & Paull Rotary Sulphur Burner**

**The Moore Rotary Screen**

**The Reynolds Screen**

Also Manufacture

**Cedar Point Foundry Grinders**

**Improved Standard Grinders**

**Improved Wet Machines**

**Rotary Pumps, etc.**

Write for Particulars and Specifications—they are free.

# DODGE

## Transmission

## Machinery

### High Grade Only

**Shafting, Hangers, Pulleys,  
Friction Clutch Pulleys.**

## DODGE MANUFACTURING CO.

640 ST. PAUL ST.  
HAYMARKET SQUARE MONTREAL LIMITED



**J. Marx & Co., - - London, E.C., England**

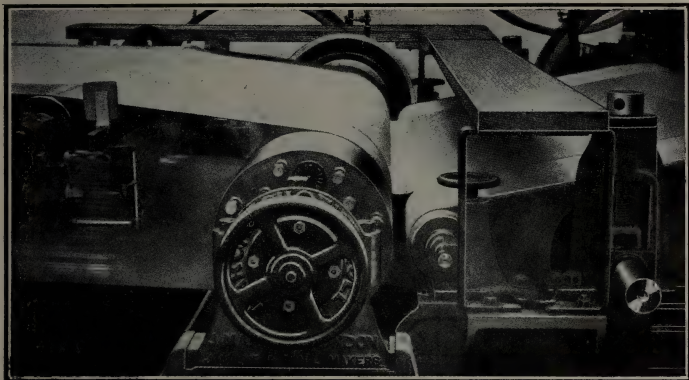

MARGALT SUCTION ROLL AT WORK

**SPECIALITIES Basalt Lava Stone Beater Rolls, Double Beaters, Stone  
Wet Press Rolls, Basalt Lava Pulp Refiners for Screenings.**

Canadian  
Representative

**Judson A. DeCew**

Canadian Express  
Building

**Montreal.**

*The*

## **Harmon Incline Screening System**

Will give greatest capacity.

Will give cleaner stock.

Will save power.

Will save labor.

Does not require use of Rakers.

Write us for full descriptive Catalogue and testimonials from the best mills in the country.

# **HARMON MACHINE COMPANY**

**WATERTOWN, N. Y. U. S. A.**

## THE EDDY PAPER TESTER

Will register the breaking strength of paper in pounds per square inch—a recognized standard the world over.

**\$15.00 net**  
postpaid.

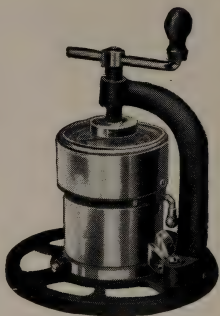

Is provided with an adjustment whereby the user can reset same, if necessary. Will do the work of higher priced machines and do it quicker. 6 inches high,

### DOBLER & MUDGE

BALTIMORE, MD., U.S.A.

## THE BEST JORDON ENGINE IS BUILT BY THE



### APPLETON MACHINE CO.

APPLETON, WIS.

SEND FOR PARTICULARS

THE SANDY HILL IRON AND BRASS WORKS, HUDSON FALLS, N.Y.

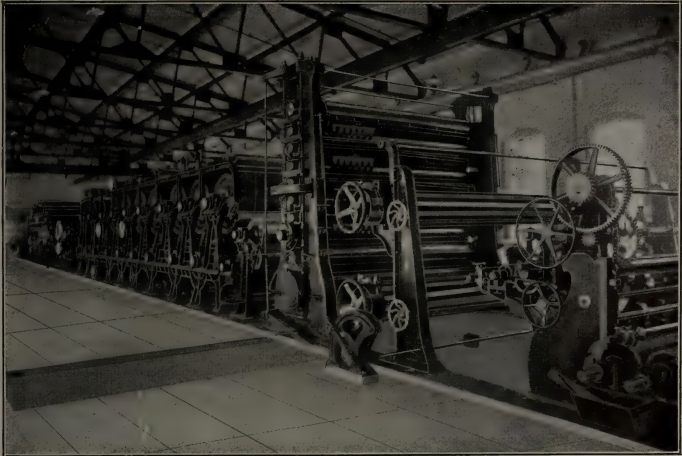

130" HARPER FOURDRINIER PAPER MACHINE.

This illustration is of the

**Ramsey Patent Single**

This valve is made also in what we call the **Double Pressure Type** where different pressures are used

1

**Pressure Grinder Valve**

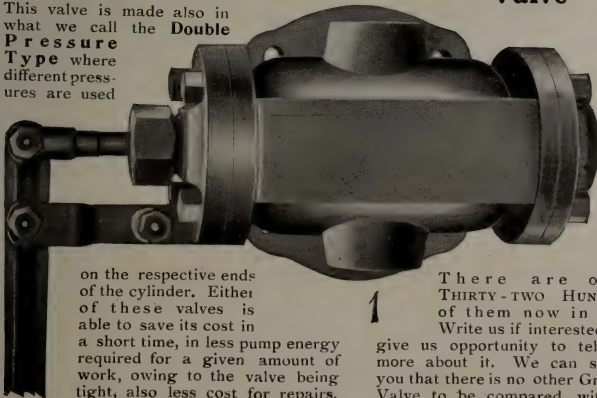

2

on the respective ends of the cylinder. Either of these valves is able to save its cost in a short time, in less pump energy required for a given amount of work, owing to the valve being tight, also less cost for repairs.

1

There are over THIRTY-TWO HUNDRED of them now in use. Write us if interested and give us opportunity to tell you more about it. We can satisfy you that there is no other Grinder Valve to be compared with it.

Sole Manufacturers

BAKER & SHEVLIN CO.,

- Saratoga Springs, N.Y.

Telegrams :  
"CALENDER, BURY"

Telephone :  
NUMBER 340

# Bentley & Jackson,

Limited

PAPER MAKERS'  
.. ENGINEERS ..

BURY, - - ENGLAND

## *SPECIALITIES.*

MODERN HIGH SPEED NEWS PAPER  
MAKING MACHINES

SINGLE CYLINDER PAPER MAKING  
MACHINES

The NEW "*MARSHALL*" PATENT REFINING  
*ENGINE*, with separate adjustment to cones and discs,  
and our Patent Ball Thrust Bearing

---

**APPLY FOR PRICES.**

---

OTTO WANDEL  
President

HERBERT H. MILLER  
Treasurer

# Wandel Screen Manufacturing Co.

WALPOLE, MASS., U.S.A.

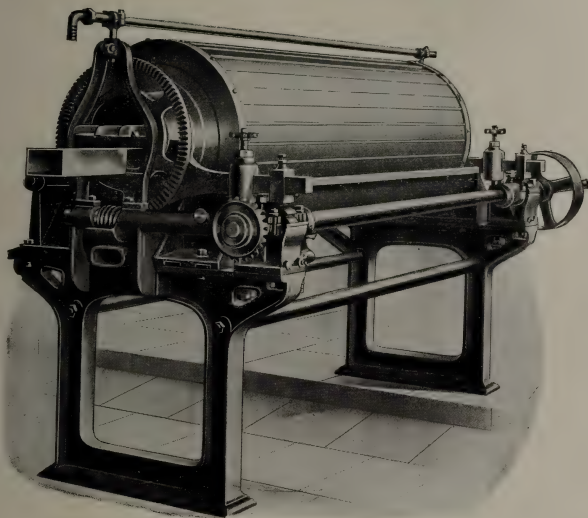

MANUFACTURERS OF THE

Quick Delivery.  
Write for Catalogue  
and list of users.  
We have no author-  
ized Agents in  
Canada.

# WANDEL ROTARY SCREEN

Over 200 Wandel  
Screens have  
been built and sold  
by us in the States  
within two years.

## SUPERIOR CONSTRUCTION



# NEW CENTRIFUGAL SCREEN

WITH HORIZONTAL SHAFT

PATENTED IN ALL PRINCIPAL COUNTRIES

SMALLEST POWER

DIRECT BELT DRIVE

HIGHEST OUTPUT

NOISELESS WORKING

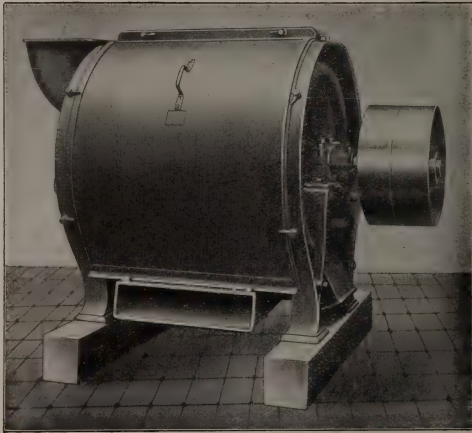

Equally well adapted for **GROUND WOOD**  
and **SULPHITE**.

*I have now sold over 800 of these Screens.*

➤ FURTHER DETAILS, PROSPECTUS AND PRICES ON APPLICATION. ➤

Complete Machinery for Wood Pulp, Paper and  
Sulphite Mills.

## J. M. VOITH,

ENGINEERING WORKS AND FOUNDRIES

HEIDENHEIM ON BRENZ, WURTEMBERG, GERMANY

The Improved **“RUTH”** Centrifugal Screen  
Used in most prominent mills in Canada and U.S.

PATENTED IN ALL PULP-MAKING COUNTRIES

**WARNING.**

Pulp and Paper Makers are cautioned to beware of the manufacture or use of Centrifugal Pulp Screens infringing Canadian patent No. 95843 of Oct. 31, 1905.

The Ruth Centrifugal Screen is the only authorized Centrifugal Pulp Screen manufactured under said patent.

Infringers on said patent will be vigorously prosecuted.



**P. P. WESTBYE, M. E.**

MANUFACTURER AND AGENT

**Pulp and Paper  
Mill Machinery.**

License Under Lease  
from the Patentee

**PETERBOROUGH, CANADA**



## **GARLAND PULP LOG Storage and Conveying SYSTEMS**

**Inventors of the CABLE CONVEYER**

We have equipped 50 of the best American PULP and PAPER MILLS with CONVEYERS, LOG CUT OFF SAWS, SLASHERS, SPLITTERS, BAND MILLS and SPECIAL MACHINES.

**Send us your plans or ask for  
Representative to call on you**

### **THE M. GARLAND CO.**

Manufacturers of CONVEYING, SAW MILL  
and WOOD DESTRUCTIVE MACHINERY

**BAY CITY        MICHIGAN, U.S.A.**

# Have You Heard the Facts About The Beloit Machines?

---

---

One Fourdrinier built for 500 feet has run 615 feet, and averages 550 feet and makes 72,000 lbs. of print in 23 hours, 110 inch trim.

Another, built for 350 feet, for manillas, is running 490 feet every day on print.

Two others, built for 250 feet on book, are now speeded up to 340 feet on book.

A cylinder machine built for 40 tons of strawboard has made 89 tons in 23 hours, and averages 76 tons per day, dryers are 116 inch face.

---

---

## Beloit Iron Works

BELOIT, WIS., U.S.A.

# DILLON MACHINE CO

## BUILDERS OF PAPER MILL MACHINERY

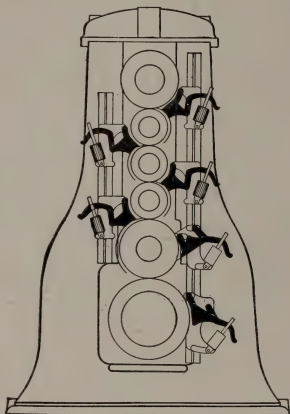

DILLON DOCTORS  
AND  
FEEDS

DILLON MACHINE CO.  
LAWRENCE MASS.

Beating Engines  
Washing Engines  
Jordan's Three Sizes—  
Single, Double & Triple  
Stuff Pumps, with  
Dillon Patent Valve  
Seating

Brannan Patent Paper  
Folders

Horizontal and Vertical  
Stuff Chests

Single and Double Paper  
Cutters

Backstands

Plates, Knives and Bars

DILLON  
PATENT  
DOCTORS  
AND FEEDS  
MADE IN  
CANADA  
BY THE  
SHERBROOKE  
IRON WORKS,  
SHERBROOKE, P.Q.

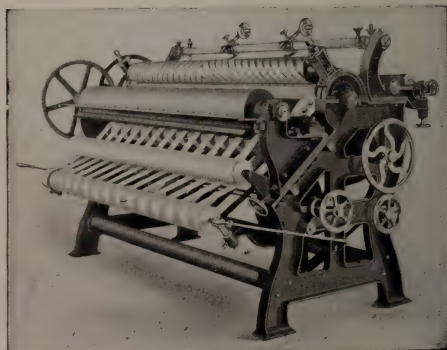

# LAWRENCE MASS., U.S.A.



---



---

# THE MOORE & WHITE CO.



PHILADELPHIA, PENN., U.S.A.



SEND FOR BULLETIN.

**V**ERY severe tests have been made of this winder, but all of them have exceeded expectations. The photograph shows the winder attached to our standard slitter part which takes up less room than any other slitter and has several very good features. The winder can be used as a rewinder by attaching a back stand to carry the roll which is to be rewound.

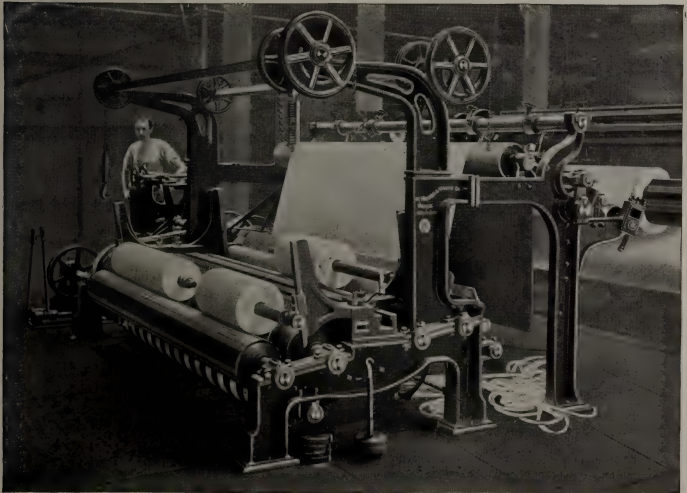

"M & W" Patented Four Drum Winder in operation.

**SATURATING, COATING AND WATERPROOFING  
MACHINERY**

**SPEED CHANGES**

**FRICITION CLUTCHES**

---



---

# HOLYOKE MACHINE COMPANY

HOLYOKE, MASS., U.S.A.

MANUFACTURERS OF

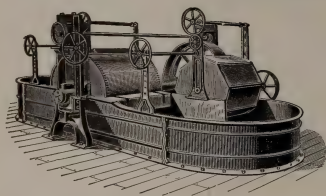

Washing and Beating Engines with  
Patent Double Hoist and Tubs of either  
wood or iron.

Hydraulic Pumps and Presses.

Rag Cutters and Rag Dusters.

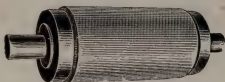

Cotton and Paper Rolls with Patent Fastenings.

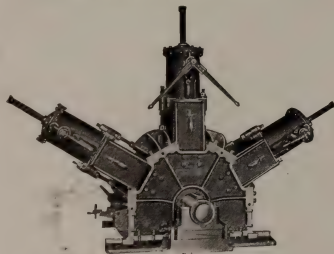

Patent Improved Wood Pulp Grinder.

Elevators, Rotary Fire Pumps and  
Friction Gearing.

Gears Accurately Spaced and Planed.

Shafting, Pulleys and Mill Work.

Machinery for Wood Pulp and  
Paper Mills.

Vertical and Horizontal Water  
Wheels with Flumes and  
all connections.

Wood Barkers, Wood Chippers  
and Wet Machines.

## Newest Designs

AND

## Highest Efficiency

Calenders. All kinds of Super-  
Calenders, Friction Calenders  
and Platers.

Chilled Iron Rolls.

Special Machinery

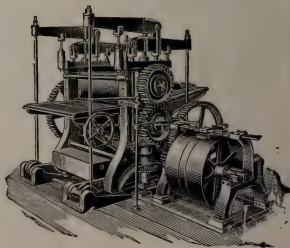

Description and Estimates Furnished; also Gear List  
and Catalogs sent on application.

# Pulp Wood Barker Bache Wiig Patent

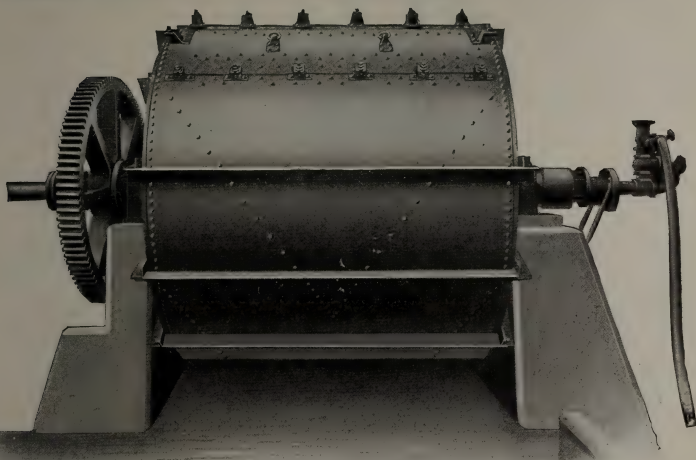

## THE LOSS WITH BARKING DRUM

Round wood covered with bark	- - - -	8%
Slabs	- - - -	23.8%
Edgings	- - - -	9.4%

## LOSS WITH KNIFE BARKER.

Round wood covered with bark	- - - -	22 to 24%
Slabs	- - - -	50%

# The Jenckes Machine Co., Ltd.

General Offices: Sherbrooke, Que.

Factories: Sherbrooke, Que., St. Catharines, Ont.

Sales Offices: Sherbrooke      Montreal      St. Catharines  
Porcupine      Cobalt      Rossland      Vancouver

---

---

JAMES BERTRAM & SON, LIMITED

LEITH WALK,

EDINBURGH - - - SCOTLAND

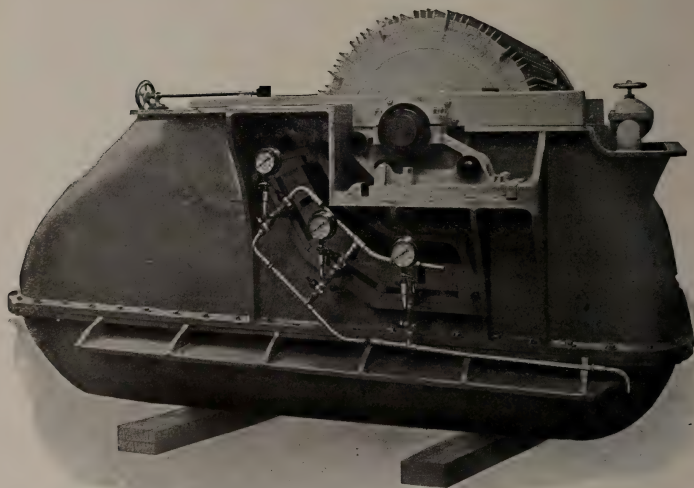

## Umpherston Beating Engine

Fitted with Three Patent Hydraulic Moving Plates

---

At work with great success, saving  $33\frac{1}{2}$  per cent in TIME  
and POWER, and producing a superior Finished Sheet  
of Paper.

---

Full Particulars on Application.

Telegrams: BERTRAM, LEITH.

---

---

# Battery Machines

(Save-Alls and Pulp Thickeners)

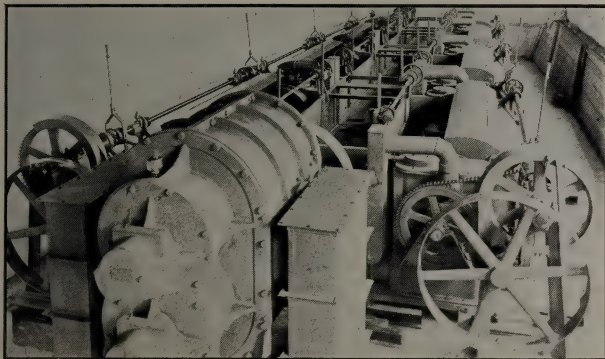

These pneumatic machines are operated in compact rows, by one blower, and by one line of shaft to each row. They have positively standardized the processes of thickening pulp and extracting stock from waste water.

Their operation is automatic, and is automatically maintained at the desired rate or density of output.

Their delivery is continuous, and the operation of the entire battery is in plain view, unobstructed by top gear or overhead connections.

No other class or make of pulp mill machinery affords the operative or the superintendent such a chance to keep his work up to the standard, without waste of time, power or stock.

---

SEND FOR FULL DESCRIPTION

---

## Sherbrooke Machinery Company

Limited

SHERBROOKE

. . .

QUEBEC



TELEGRAMS }  
 CABLEGRAMS } MILNE, EDINBURGH

Code A B C 4th & 5th Editions'

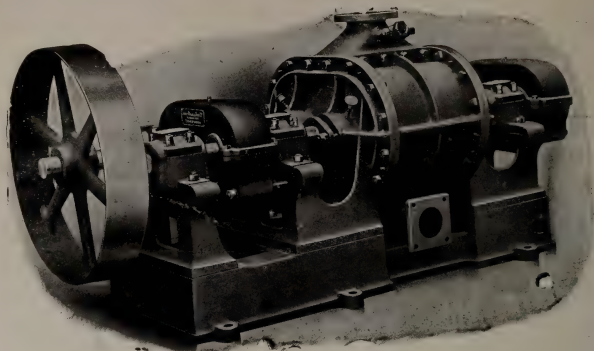

# HIGH DISPLACEMENT VACUUM PUMP

*(Made in Various Sizes)*

Suitable for

SUCTION ROLLS or VACUUM BOXES

MANUFACTURED BY

**JAMES MILNE & SON, LIMITED**

MILTON HOUSE WORKS, EDINBURGH

*DESIGNERS  
 AND  
 MANUFACTURERS  
 OF HIGH CLASS  
 PAPER MILL  
 MACHINERY*

*FAST RUNNING  
 PAPER MILL  
 MACHINERY  
 A SPECIALTY  
 LEAST VIBRATION  
 LEAST BREAKAGES*

*Don't Touch Your Mill Equipment Without Trying Milne.*

— — —  
WHOLESALE LUMBER YARD  
BURLINGTON, Vt.  
— — —

*J. R. Booth*  
*Manufacturer!*

— — —  
LUMBER  
PULP AND PAPER  
— — —

*Ottawa, Ont.* Dec. 8th, 1910

The Green Bay Barker Co.

Green Bay,

Wis.

Dear Sirs,

In reference to the Rotary Pulp Wood Barker.

I have four of these in operation, and I find them very satisfactory, particularly on small or crooked wood, and I find quite a saving over the old style of Barkers; they will also do considerably more work. As far as I know there have not been any repairs required on mine since I got them. I can recommend them to any one requiring a good Barker.

Yours truly,

*J. R. Booth*

CABLES, "PUMPS, BURY"

# WALMSLEY'S

We have Paper Making Machines 175 in. wide,

---

Walmsley's Enclosed

FITTED WITH

Specially adapted for the

## DRIVING OF PAPER MACHINES

GIVING A VARIATION OF 10 to 1.

ESTIMATES GIVEN FOR

---

CHARLES WA  
PAPERMAKERS'  
ENGINEERS,

HIGH SPEED

# Papermaking Machines

making paper at over 600 feet per minute.

---

# Steam Engines

FORCED LUBRICATION

OVER 280 OF THESE ENGINES SUPPLIED

FOR PAPER MACHINE DRIVING ALONE.

COMPLETE PAPER MILL PLANT

---

# LMSLEY & Co.,

# BURY,

LIMITED.

Near MANCHESTER.

# Wilson-Paterson Co'y



127 BOARD OF TRADE BLDG., MONTREAL.

Agents for the United Alkali Co. of England

## **OFFER TO THE TRADE:**

Caustic Soda 60° to 78° Soda Ash, Caustic Potash, Sal Soda, Silicate of Soda, China Clay, Rosin size and a full line of Rosins, direct shipment from the south.

**Contracts made for regular supplies.**

# PARSONS TRADING COMPANY

EXPORTERS OF PAPER TO ALL PARTS OF THE WORLD

20 VESEY STREET, NEW YORK

BRANCH OFFICES AT

LONDON

SYDNEY

MELBOURNE

WELLINGTON

CAPE TOWN

BOMBAY

HAVANA

MEXICO, D.F.

BUENOS AIRES

**CORRESPONDENCE WITH MILLS SOLICITED**

# THE CARTHAGE CHIPPER

WILL INCREASE YOUR CHIPS. WILL  
DECREASE YOUR SAWDUST. By virtue  
of its Design and its Patent Feed Spout it takes a  
MINIMUM AMOUNT OF POWER.

---

Ask Anglo - Newfoundland Development Co.  
Ask Laurentide Pulp and Paper Company.  
Ask The Riordon Paper Company, Limited.

---

OR WRITE

**CARTHAGE MACHINE CO.**  
**CARTHAGE, N.Y.**



# Pulp and Paper Magazine of Canada

A Magazine devoted to the interests of Canadian Pulp  
and Paper Manufacturers and the Paper Trade.

SUBSCRIPTION PRICE: \$2.00 a year. Single Copies, 20 cents.

The Pulp and Paper Magazine is published on the second Tuesday of each month. Changes of advertisements should be in the Publishers' hands not later than the 1st of the month, and, where proofs are required, four days earlier. Cuts should be sent by mail, not by express.

PUBLISHERS:

BIGGAR-WILSON, LIMITED,

Confederation Life Building, Toronto, Canada

## Ontario Government Paper Contracts

The Ontario Government has awarded the contracts for the paper required in carrying on its business during the next five years, beginning with February 1st last. These contracts involve an expenditure of about \$35,000 per year, so they are of considerable importance. The contracts for No. 1 print paper, supercalendered papers and special statute paper were awarded to the Kinleith Paper Company, Limited; that for coated paper to the Georgetown Coated Paper Mills; and that for cover paper to the Montrose Paper Co.

Full details of the award have so far not been published, but the papers for which tenders were invited may be stated as follows: Double Royal, 27 x 41, No. 1 print, 65 lbs. to ream of 500 sheets (in each case); Double Demy, 24 x 36, No. 1 print, 55 lbs. Double Royal, 27 x 41, No. 1 super-calendered, 80 lbs.; Double Demy, 24 x 36, No. 1 super-calendered, 60 lbs.; Double Royal, 27 x 41, No. 1 coated, 70,

80 and 100 lbs.; Double Demy, 24 x 36, No. 1 coated, 60, 70 and 80 lbs.; Double Cap, 25½ x 30, No. 1 print, 46 lbs.; Royal Cover, 20 x 29, mill finish, color blue, 36 lbs.; Demy Cover, 18 x 25, mill finish, color blue, 30 lbs.; Extra Quality Cover Paper, 25½ x 36, mill finish, color blue; Extra Quality Cover Paper, 27x41, mill finish, color blue, 100 lbs.; Extra Quality Cover Paper, 29 x 41, mill finish, color blue, 150 lbs.; Special Statute Paper, 27 x 41, double royal, No. 1 Special, 65 lbs.

The successful tenderers are to be congratulated, but while their ability and purpose to give good value are not questioned for a moment, it may be remarked that the trade as a whole would have been much better satisfied if the conditions governing the award had been other than those actually existing. While the gentleman who acted as paper expert and judge for the Government may have ample qualifications in his particular sphere in the educational de-

partment, the paper manufacturers can only accept on faith his qualifications to act as an expert on paper to the extent of judging on a technical matter in which thousands of dollars of public money are involved.

The duration of the contract is another point on which it is well within the mark to criticize the Government. Five years is altogether too long a period to figure ahead. Neither for the paper manufacturers who have to deliver on contract, nor for the people who have to pay the piper is such a long date either advisable or fair. It is understood also that no penalties are attached to non-fulfilment of contract. The Dominion and United States Governments both require in such matters the putting up by the contracting parties of some sort of bond or percentage which shall be forfeitable in the event of non-compliance with the terms of the contract. This is a safeguard which, it seems to us, it would be well to incorporate not only in paper, but in all contracts in which the people's money is involved, particularly in cases involving a term of years. If the contracts had been for one year, which probably would have been more satisfactory all round, this point would not be of so much consequence.



### THE TARIFF COMMISSION.

The debate in the Dominion House on the Hon. W. T. White's resolution providing for the establishment of a Tariff Commission came up last week and resulted in some warm criticism on the part of the Opposition, though when Sir Wilfrid Laurier was in power he promised that very thing. They called it a

"new and radical departure from British and Canadian constitutional practice in the matter of national taxation," said it was nothing more than a device to bring in high protection, and scored it because "it would be a subversion of ministerial responsibility." The Premier to these criticisms replied that in essence the Commission was intended merely to substitute a satisfactory and scientific method of collecting data on all tariff matters for the desultory and unscientific methods of the past. That the government's intention is to have a board purely advisory and not to delegate to its own functions in the actual making of a tariff is indicated in the terms of the resolution itself.

The Commissioners will consist of three members, including the chairman, whose duties it will be to inquire into (a) The price and cost of the raw materials of any product in Canada and elsewhere, and the cost of transportation thereof from the place of production to the place of use or consumption; (b) the cost of production in Canada and elsewhere; (c) the cost of transportation from the place of production to the place of use or consumption, whether in Canada or elsewhere; (d) the cost, efficiency and conditions of labor in Canada and elsewhere; (e) the prices received by producers, manufacturers, wholesale dealers, retailers and other distributors in Canada and elsewhere; (f) all conditions and factors which affect the cost of production and the price to the consumers in Canada; (g) generally all the conditions affecting production, manufacture, cost and price in Canada, as compared with other countries, and to report to the Minister. (2) To make inquiry into any other matter upon which

the Minister desires information in relation to any goods which if brought into Canada or produced in Canada are subject to or exempt from duties of customs, and to report to the Minister.

(3) To hold, when empowered by the Governor in Council, an inquiry under section twelve of the Customs tariff, 1907, in the same manner as the Judge of the Exchequer Court or any other judge therein referred to may hold inquiry when so empowered. (4) To inquire into any other matter or thing in relation to the trade or commerce of Canada which the Governor in Council sees fit to refer to the commission for inquiry and report. The commissioners are to be given power to summon witnesses and to take evidence.



#### POSTAL RATES ON PERIODICALS CONTAINING SAMPLES OF PAPER.

In last issue the "Pulp and Paper Magazine" printed some correspondence which had passed between its publishers and the Postmaster-General in connection with the inclusion of samples of paper in magazines, and with the postage rates charged by the Post-office Department when this is done. Under the present regulations, certain journals in the United States, containing advertising samples of paper can be mailed to subscribers in Canada at the rate of 1c. per 4 oz., whereas if the publisher of a Canadian journal were to include such samples it would have to pay for transmission through the mails at the rate of 1c. for 2 ounces, or just double its American rival. We had no desire to request special privileges for our own magazine, as was understood by the Postmaster-

General, but took the matter up because present regulations act as a discrimination not only against Canadian publishers, but against Canadian manufacturers of paper who are debarred from making their products known through the trade press in the manner enjoyed by their United States rivals.

The following is the reply of Hon. Louis P. Pelletier, Postmaster-General, to our second letter to him, which was printed in last issue:—

Ottawa, January 19th, 1912.

Gentlemen:—With reference to your further communication of the 9th instant, asking that special privileges respecting samples of paper be granted and that these be authorized as inserts in the "Pulp and Paper Magazine" passing by post at the reduced newspaper rate, I beg to say that I have again gone carefully into the question and find that samples of paper considered separately and tendered for mailing alone are liable to postage at the sample rate of one cent. per two ounces to each separate address, also that a regulation appearing in section 47, page 12 of the Postal Guide has been made and has for many years been in force, prohibiting in second class matter such enclosures as samples of paper, and prescribing as penalty for their enclosure that postage shall be collected on the whole mailing at the rate of one cent per two ounces to each separate address.

The Department is now carrying all newspaper matter at a loss. Should your request be in this instance specially considered, the Department would be flooded with similar requests for enclosures from others, and could not do otherwise than deal with them impartially and treat all alike. The result would be

disastrous to the postal revenue of the Department.

As regards the case of the \_\_\_\_\_  
 \_\_\_\_\_ published at \_\_\_\_\_  
 which you cite, it may be remarked that the administration of the postal law of the United States governing similar applications has created an abuse which has now assumed such tremendous proportions that the United States Postal Department, apart from losing millions of dollars annually in the way of revenue, requires to pay large amounts to the railway companies for the forwarding of newspapers and periodicals. In order to prevent a repetition of such evil in Canada, the policy of the Department has been to require publishers to fully live up to the requirements of the Post Office Act and postal regulations governing the transmission of second class matter.

As a relaxation of the regulations governing second class matter—as desired in the present instance—would not only involve loss of revenue to the Department, but tend to intensify the existing conditions in regard to the transmission of newspaper matter, I regret the Department is not in a position to give your application favorable consideration at the present time.

Yours Truly,

(Signed) Louis P. Pelletier,

Postmaster-General.

To the above we replied briefly, mentioning the possibility that if the United States Postal authorities should carry out such radical changes in rates as is implied above, this in itself may equalize matters and remove the handicap under which Canadian publishers and Canadian manufacturers of paper now suffer.

\* \* \* \*

Some of our friends in the United States are inclined to say: "You Canadians are going ahead very strenuously in the work of building news print mills to supply free paper to the United States; but what will happen if the Washington Government rescinds its legislation allowing pulp and paper made from non-surtaxed wood to come in free? In reply to the query we would say that nothing very alarming would happen. The particular clause which was tacked on to the United States Reciprocity bill, and then passed quite independently of that ill-fated measure, is undoubtedly of benefit to Canadian paper manufacturers, but new mills would have been put up, even if the clause had never been heard of, and if it be repealed it will only be a return to the statu quo, and we do not think there will be any great outcry.

\* \* \*

Some months ago the "Pulp and Paper Magazine" referred somewhat disparagingly to the disposition to build certain classes of paper mills before trade conditions fully warranted such expansion. The result is shown to-day in the cutting of prices for coated paper, in the attempt on the part of new competitors to enter a market which was already fairly well supplied. It is true that considerable coated stock is imported from Great Britain, and that a certain proportion comes from Germany in an underhand way by way of English channels. But there was scarcely enough possible displacement to warrant for the present more than a legitimate extension of business on the part of mills already in existence, and the main tendency of the entry of new enterprises into the field is to de-

moralize the trade, at least until such time as the industry settles down.

\* \* \*

The Imperial Government is desirous of having an international convention to discuss plans for a uniform copyright law throughout the world. It is understood that it finds it impossible to suggest measures to this end if Canada retains its present position on this subject, or the position taken by the late Dominion Government. It is stated, indeed, that Germany and some other countries refuse to consider this matter at all unless Canada's attitude be changed. It is to be hoped that some common basis be reached of fairness to all authors as well as to Canadian publishers and paper manufacturers.

\* \* \*

The question of workmen's compensation for injuries suffered during their daily work is one of great interest to pulp and paper manufacturers, which the Canadian Manufacturers' Association is doing wisely to devote attention to. F. W. Wegenast the solicitor who is looking after this matter for the Association, contends that the best method of meeting the problem may be described as the "collective" system, such as is in use in Germany, where an injured workman obtains redress from a common fund put up by the association of employers. The individual liability system proves too great a strain on industry, for under that it is necessary for each mill-owner to capitalize enough to make payments.



L. Fleck, manager of the Georgetown Ont., Coated Paper Mills, fell while skating and had the misfortune to break his leg.

## CONSERVATION COMMISSION.

The third annual meeting of the Conservation Commission took place in Ottawa on the 16th ult., among those present being Hon. Clifford Sifton, the chairman; Senator Edwards, Hon. Sydney Fisher, Hon. Martin Burrell, Dr. Hodgetts, Dr. J. W. Robertson, etc. Reports were presented on Public Health, Town Planning, Rural Sanitation, Meat Inspection.

Reports were also presented on lands and minerals, Hon. Clifford Sifton urging the importance of fully developing the peat industry.

The report on water-powers, submitted by M. L. G. Denis, advocated the systematic inspection of stream flow in connection with power conservation, and an investigation of undeveloped water-powers held by private individuals for speculation.

Dr. J. W. Robertson, in the report of the Committee on Lands, stated that the farmers of Canada were not conserving the fertility of the soil. Some 46 per cent. of the farms examined in the West had shown a substantial decrease in production. Systematic rotation of crops was the only remedy, and he stated farmers had more need of scientific methods on the farms.

R. H. Campbell, Superintendent of Forestry, appealed for the Rocky Mountain forest reserve and an expert forester in charge. An appropriation of \$110,000 was recommended for the reserve for the year.

The appointment of a chief fire inspector and staff as a part of the Railway Commission was urged by Hon. Clifford Sifton, and Prof. Fernow will be the board's representative to the Railroad Board in this respect.



The Belgo-Canadian Co., Shawinigan Falls, Que., contemplate putting in a fourth machine so as to increase the output to 165 tons daily. The machine proposed would be 184 inches wide, the largest of its kind in Canada.



## Pulp and Paper News

The Grès Falls Pulp Co., Point à Madeleine, Que., will double the capacity of their pulp mill.

\* \* \*

A large American paper bag manufacturing company is said to contemplate erecting a branch factory at Niagara Falls, Ont.

\* \* \*

T. H. Cramp, who for many years was connected with Brown Bros., wholesale stationers and paper dealers, Toronto, died last month of pneumonia.

\* \* \*

The Grenville Board and Pulp Co., Thorold, is installing additional machinery for the manufacture of pressed pulp specialties, insulation boards, etc.

\* \* \*

The British American Wax Paper Co. has brought action against Shortiss, of Toronto, for an order restraining defendant from alleged infringement of patent.

\* \* \*

W. J. Findlay & Co., Strathcona, Ont., are now manufacturing building paper instead of wrappings as formerly. Their product is meeting with a good demand.

\* \* \*

The Green Bay Barker Co., Green Bay, Wis., whose barker is now made under contract in Canada, will establish a branch manufacturing plant in this country.

\* \* \*

J. R. Booth, of Ottawa, has donated \$1,000 to the Salvation Army to assist it in the building of a "citadel" in that city. Nine other gentlemen donated the same amount.

\* \* \*

Capt. R. R. Barber, son of the veteran paper-maker of Georgetown, Ont., John R. Barber, is on a prolonged visit to Florida, recuperating after his severe attack of pneumonia.

The Ontario and Minnesota Power Co., Limited, are applying to the Ontario Government for an Act authorizing it to expropriate lands required for the erection of a pulp mill.

\* \* \*

The Arnprior Box Co., recently incorporated for the purpose of making cheese boxes from fibre board, have obtained temporary premises at Arnprior. L. A. Whyte is manager.

\* \* \*

W. Vandenburg, master mechanic in the Brompton Pulp and Paper Mills for several years, has been appointed to a similar position with the St. Maurice Industrial Co., La Tuque, Que.

\* \* \*

Tenders will be called for printing of Dominion Bank notes and postal and inland revenue stamps for a term of five years. The use of special paper and multicolor printing may be required.

\* \* \*

E. P. Foley, of the Foley-Rieger Pulp Co., Thorold, is one of the candidates in the new municipal elections to be held at that place on the ground of irregularity in the one held last month.

\* \* \*

Mrs. M. O. Leighton, a sister of E. B. Eddy, founder of the E. B. Eddy Co., Hull, died in New York last month at the age of seventy-six. Officials of the company attended at the funeral in Bristol, Vt.

\* \* \*

A disastrous fire broke out on the 5th inst. in the premises of Robert Duncan & Co., Hamilton, bookbinders. The plant was partially destroyed at a loss of \$50,000. Cloke & Son, stationers, also lost over \$20,000.

\* \* \*

The Garden City Paper Mills, St. Catharines, Ont., are rushing work on the construction of their mill for making tissue papers, and expect to be ready for operation in about a month with an output of eight tons daily.

Douglas & Ratcliff, Limited, paper dealers, Toronto, at their annual meeting last month re-elected F. L. Ratcliff president. John G. Sutherland was elected vice-president, and Norman Ratcliff secretary-treasurer.

\* \* \*

The National Paper Co., Valleyfield, Que., has started operations manufacturing coated paper with two machines with a capacity of about six tons per day. Its selling representatives are Alex. White in Toronto and P. DeWolf in Montreal.

\* \* \*

The Swanson Bay Forests Wood Pulp and Lumber Co., Limited, who lease some 84,000 acres of pulp-wood and timber areas, and have been shipping pulp for some time past, are now controlled by Evans, Coleman & Evans, Vancouver.

\* \* \*

The appeal of Rice vs. Rudd Paper Box Co., Toronto, against a decision of Chief Justice Meredith awarding the latter \$1,223 and costs on an insurance policy alleged to have been lost to them through Rice's breach of duty to them was dismissed with costs.

\* \* \*

The Upper River Fraser Lumber Co. are now offering to the public \$1,500,000 6 per cent. first mortgage bonds. The company own about 280 square miles of pulpwood and timber areas in British Columbia. Hon. W. C. Edwards is one of those prominently connected with the concern.

\* \* \*

The Dominion Government included in its estimates for the current year an appropriation of \$200,000 for storage dams on the Upper Ottawa River. This work will be to the great advantage of pulp and paper manufacturers, not only for log-driving purposes, but as a regulator of the supply of power.

\* \* \*

The Black-Clawson Co., Hamilton, O., have just finished the building of two large paper machines for the Lake Superior Paper Co., Sault Ste. Marie,

Ont. They are 156 in. wide, and are designed for making news print 12 feet wide at a running speed of 600 to 700 feet per minute.

\* \* \*

The Quebec Bank entered action against the Sovereign Bank of Canada in the non-jury assize court, Toronto, for the payment of \$24,240.82, alleged to be due under an agreement for deliveries of wood in connection with the financial difficulties of the Imperial Paper Mills of Canada.

\* \* \*

B. F. Pearson, editor of the Halifax N.S., "Chronicle" and promoter of the Dominion Coal Co. and other great industrial enterprises in Canada and Latin America, died last month at the age of fifty-eight. F. B. McCurdy, M.P., who is interested in pulp enterprises in New Brunswick, is a son-in-law.

\* \* \*

The Walker Pulp Stone Co., Toronto, is preparing to build a plant at Ogdensburg, N.Y., and expects to open another at Prescott, Ont., during the coming summer. The pulp stones are understood to be a composition of emery, crushed stone and cement, made by a secret process, patented in Canada and the United States.

\* \* \*

In the recent deputation to Ottawa from Campbellford, Ont., asking the Government to postpone the moving of the dam at that place, the Northumberland Paper and Electric Co. were not represented as they are steadily changing their paper mill to the use of electric power. The pulp mill built last year is using electricity exclusively.

\* \* \*

Everyone sympathizes with the friends and relatives of Eldridge Stanton, who with his wife was the victim of the terrible tragedy at Niagara Falls a few days ago, when the ice-bridge gave way without warning. Mr. Stanton was secretary-treasurer of the O. B. Stanton & Wilson Co., Limited, stationers and printers, Toronto, of which his brother, O. B. Stanton, is president.

The Consolidated Pulp and Paper Co., which, as announced in our list of new incorporations, has been recently organized in St. John, N.B., will take over the Partington pulp mill, and make extensive additions to it, although it is not the intention to erect a paper mill in connection with it as has been reported. The Gibson lumber areas have been purchased by the new organization, as well as the rossing and sawmills at Marysville.

\* \* \*

The conflict of interests between the town of Fort Frances and E. W. Backus, of the Ontario and Minnesota Power Co., seems to be in a fair way toward settlement. In return for the town's not making objections to expropriation if necessary to obtain a site, he promised to begin at once the building of a 50-ton paper mill and the completion of the pulp mill. He also promised to extend later the paper mill and to put in a book machine.

\* \* \*

The Minnesota and Ontario Power Co.'s application for an injunction against the Rat Portage Lumber Co. to restrain defendants from interfering with the natural flow of the waters of Rainy River past plaintiffs' lands and mills at Fort Frances by damming and storing the waters of certain lakes has been refused by Justice Middleton in Toronto on the ground that plaintiffs' rights are by no means clear, and that defendants have used for years the waters in question.

\* \* \*

For some time past reports have been current regarding the establishment of another large pulp and paper mill project for Thorold. These reports came to a head in a dispatch from that town stating that James Battle, Thorold, is the trustee for parties who refuse to divulge their names, but who fully intend to start building operations at an early date on a mill to employ over 150 men, to be ready for work by January 1st, 1914. The township council has passed a by-law to fix the assess-

ment on a site for the new concern at \$10,000 for a period of ten years. This property consists of twenty-five acres, near Lock 25, on the south-east side of the new Welland Canal. Power will be obtained from the Ontario Power Co.

\* \* \*

The Ontario Pulp and Paper Co., Toronto, incorporation of which was noted in last issue, was organized to operate the Imperial Pulp and Paper Mills, Sturgeon Falls, recently acquired by the Dominion Bond Co. The plant at Sturgeon Falls is being overhauled and plans made for operating it on a proper basis. The head office of the Spanish River Pulp and Paper Co., Espanola, affiliated with the first-named concern, will be removed to Toronto, with A. E. Millington, the general manager, in charge. E. V. Fox is sales manager. Securities of the Spanish River mill to the extent of \$2,000,000 preferred and \$2,000,000 common stock have been listed on Toronto Stock Exchange. It is hoped to have the new 110-ton news print mill in operation next month. The ground wood plant, capacity 150 tons per day, realized good profits last year.



### THE RAILWAYS AND FOREST FIRES.

While the Canadian Forestry Association was holding its annual meeting in Ottawa, the subjects of forest fires and the relation of the railways thereto was being brought before the railway commission at the instance of the conservation commission.

Judge Mabey, at a hearing before the railway commission announced that new regulations are being drafted dealing with forest fires. He said: It is not our desire that these regulations should be unreasonable. The loss to the country, however, from the burning of timber directly due to the operation of railways has been something awful and the question should have been taken up 25 years ago. It was stated at the hearing that

the Great Northern Railway employed oil on all trains from Seattle to Vancouver and never had any fires. Dr. B. E. Fernow stated that oil burners, if properly operated, were an effectual preventive against fire while spark resistors in locomotive flues were never absolutely reliable. He read a draft of the regulations which he has submitted to the railway commission for fire protection along railway lines. They provided that where oil-burning locomotives were not used there should be patrols along the right-of-way, that locomotives should be fitted with ashpan screens and spark arresters, that all fire-fighting equipment should be inspected by the railway commission. A new and very important provision was that in cases where owners of adjacent wood lands allowed slash within 100 feet of railway tracks or otherwise encouraged fire railway companies which gave them due notice of this condition would not be responsible for fire loss caused by them.

Judge Mabee stated there was not a ranger along the whole north shore of Lake Superior. "Why not protect the young growth as well as the old?" said the chairman. "My experience has been that railway companies pay no attention whatever to the infants."



#### FORMATION OF FOLDS WHEN LINING PAPER.

A very disagreeable occurrence when lining good strawboard, and also when lining both sheets of paper and rolls, is the formation of folds in the gummed paper. When lining rolls, care must firstly be taken that the apparatus for unwinding and guiding the gummed paper is in a perfect condition, in order that the web of paper may run perfectly smoothly and have the proper tension. The guide roll arranged directly at the rear of the paper roll to be unwound must be located so that the web of paper is sharply bent at this place even when the paper roll gradually becomes smaller and smaller; the web of gummed paper is greatly aided in lying flat, both when it is wet and when it is dry,

by employing a few guide rolls having spirals of wire soldered thereon running from the middle to the outside. The brake at the unwinding rod must be sufficiently powerful in order that the paper is always tensioned uniformly. All the rollers must be exactly parallel with the unwinding rod, sufficiently staple and exactly round. Under certain circumstances it may happen that the cylindrical shape is deformed by dirt. If the web is tensioned too little at one or both sides this can be remedied by suitably enlarging the periphery of the rollers at the ends of the paper web by letting strips of paper run on them. For preventing folds it has been found preferable to drive the paper guide rolls separately, their speed being somewhat higher than that of paper. The driving gear of these guide rolls must be capable of being connected and disconnected separately, and, of course, is employed only in the event of its being necessary owing to the formation of folds. Further, it is important that the web of paper is not introduced rectilinearly into the press, but winds round the top roll of the press in as great a curve as possible before it runs into the press. Finally, of great influence on the work of lining paper is the uniformity of the paper, because when this has irregularities smooth lining without folds is impossible.



#### MEASUREMENT OF COLORS.

Referring to the attempts to numerically determine the bleaching qualities of cellulose, unfortunately this is not possible as long as the whiteness of the bleached pulp cannot be definitely expressed. Recently Sindall and Bacon, London, have returned to this question. They recommend as "standard white" chemically pure, powdered calcium sulphite pressed in a certain manner between glass plates. By comparison with this standard white the gradations in the whiteness of bleached pulp are to be determined with the aid of Lovibond's "tintometer." This apparatus comprises a stereoscope-like device, and

when looking through the same one eye sees the standard white. By placing to be determined whilst the other eye sees the standard white. By placing colored glasses, which are supplied in red, yellow and blue of various depths with the apparatus, in front of the above-described standard white in the apparatus, the color in the two halves of the apparatus can be made to agree. The shade of color of the body under investigation is then expressed in red, yellow and blue corresponding to the colored glasses which were necessary for obtaining the color of the body in question.

When measuring colors certain rules must be observed. Above all it is necessary for the kind of light which is employed to be more particularly defined. Reliable results can be obtained only with diffused daylight reflected by a standard white reflector. The axis of the instrument should in no case deviate more than 40 deg. from the vertical. The distance between the eye and object should be about 25 cm. The duration of the observation should not exceed 3 seconds for dark colors and 5 seconds for light colors, because otherwise the eye becomes tired and the results become defective. Arthur W. Knapp complains of Lovibond's apparatus that the number of the colored glasses is not constant, and that uncertainties arise inasmuch as one and the same shade of color can be expressed with glasses of various color value. For example he has obtained the same shade of color with

3.0 red	5.0 yellow	1.0 blue
as with		
2.2 red	4.2 yellow	0.2 blue

Various reports on another apparatus for measuring colors, i.e., Kallab's "color analyser," have appeared in German journals. This apparatus comprises four superposed, transparent, colored discs of celluloid rotatable about a common axis. Each of these colored discs, red, yellow, blue and grey, is divided into ten sectors of various intensity

of color. Now when the red or yellow disc is moved over the stationary blue disc the various shades of color appear which can still be covered by the grey disc. For example, in order to obtain a certain brown No. 4 of the red disc and No. 9 of the yellow disc are placed over No. 1 of the blue disc. When the colored discs are divided into ten sectors 8,800 various shades of color can be produced with Kallab's apparatus. Kallab's apparatus is said to be cheaper and more convenient to manipulate than Lovibond's. Also, tiring of the eye is said to be avoided. Kallab's apparatus has already been repeatedly used in scientific work when exact determination of shades of color was important, and it has also been proposed to establish an international designation of colors on the readings of this apparatus.

In contradistinction to the apparatus just described, the additive mixture of colors is employed in two other apparatus. In Frederick E. Ives' apparatus colored light falling through red, green and blue glasses is mixed by means of 12 lenses seated on the periphery of a rapidly rotating wheel and falls on the one half of a condensing lens into whose other half passes the light reflected by the body under examination. By means of screens in front of the colored glasses the relation of the three colors to one another can be so regulated that the same shade of color appears in the two halves of the condensing lens. The portion of each color can then be directly read at the screens.

Results obtained by the last apparatus have not yet been published. It appears suitable, however, that the paper trade should have special interest in the measuring of colors and, particularly, it would seem possible to overcome with one of the above-described apparatus the uncertainty which at present still exists in judging half-stuffs or finished paper with regard to their whiteness.



## WASTE SULPHITE LIQUORS.

(*Special to Pulp and Paper Magazine.*)

Paper making is frequently mentioned as an instance of the complete utilization of wood by those who are unacquainted with the fact that over one-third of the wood used in the manufacture of pulp in Canada is manufactured by the sulphite process, a process which involves a loss of practically one-half of the weight of the barker wood used. That is to say, of the 622,000 cords of wood used in manufacturing pulp in Canada in 1910, about 100,000 were wasted. This was due to the fact that the cellulose which is the only constituent of wood which is valuable as a paper forming fibre, comprises only about 50 per cent. of the weight of the wood, varying in proportion with the specie and age of the timber.

The other half of the weight of the wood is made up of a number of little known constituents such as resins, lignin and other carbo-hydrates, which are crystallized in the cellulose and must be removed if the fibre is to be of good and lasting quality.

The two processes adopted for the removal of these impurities are the sulphite and soda processes. 242,000 cords of wood were treated by these processes in Canada in 1909. In each case the organic constituents of the wood which as pointed out constitute about one-half the total weight of the wood, are dissolved out with a chemical solvent and are carried away.

In the comparatively unimportant soda process, which is only used in a few mills in Canada, consuming about 10,000 cords yearly, the wood constituents contained in the liquor are not altogether wasted. The liquid contains, together with the wood constituents, the valuable soda which can be recovered without much cost. The solution is evaporated to a thick syrup and in this condition will burn by itself when ignited, the wood constituents furnishing the fuel. The heat thus generated is used to eva-

porate to syrup another portion of the thin liquor. In the soda process, therefore, one-half of the wood consumed is used for pulp and one-half for fuel. There is no real waste.

Unfortunately, in the important Canadian chemical process, the sulphite process, no such utilization of the wood carried off in the liquor is possible, because the bisulphite which the liquor carries along with organic matter, cannot be reclaimed commercially and the organic matter in the liquor will not sustain combustion without the use of extra fuel.

This bisulphite liquor, carrying about one per cent. of inorganic and ten per cent. of organic matter is, because of a lack of any means of profitably disposing of it, run off into streams. About 115,000 cords of wood are run off into the streams of Canada yearly from the sulphite pulp mills. Not only does this disposal of sulphite liquor represent a great waste of a forest product containing valuable constituents, but it results in considerable damage by the contamination of the streams. The poisonous sulphuric acid which is contained in the liquor harms or kills everything living in the water in the vicinity of the mill. The fine fibres which are unavoidably carried into the water catch in the gills of fish, interfere with their proper breathing, and cause their death from suffocation, even at considerable distances from the mill. Further, the enormous quantities of organic matter discharged into the rivers from the sulphite mills, is eventually broken down by decay into substances injurious to animal and vegetable life. These substances give rise to foul odors and render the vicinity of a sulphite mill on a small stream, an undesirable site for living.

For these reasons, and because it is important that some commercial means be found of utilizing the half of the

wood that is not used by the sulphite mills, the subject has received much attention from inventors. This has been more the case in Europe where the governments have required that the manufacturers dispose of the waste so as to avoid any damage to streams or their inhabitants, and where the chemical utilization of by-products has been more highly developed than in Canada and the United States.

Uses which have been suggested for sulphite liquor are: wood preservatives, tanning materials, road binders, and a source of raw material for alcohol.

As a wood preservative, sulphite liquor has not been a success. For this purpose it was evaporated, mixed with other chemicals, such as zinc chloride, creosote or tar, and forced into the wood under heat and pressure. It was found that the sulphite mixtures leaked out of the wood and as a preservative against decay could not compete with creosote at ten cents a gallon.

Sulphite liquor, or spruce extract, has had some vogue as a tanning agent. A small quantity is used in Canada each year and the use seems to be growing. Strangely, the spruce extract used in Canada is nearly all imported from the United States. About 5,000 gallons are used yearly, valued at a few cents a gallon. Spruce extract cannot be called a successful tanning agent. The compounds which it forms with the albumen of the hide are not stable. It cannot compete with the cheap vegetable tannins, such as quebracho, which are imported from the tropics.

Concentrated sulphite liquor has been used to lay the dust and form a permanent surface on public roads. The Office of Public Roads, United States Department of Agriculture, has reported that it may be classified as a temporary or semi-permanent dust preventive or road binder. Where oil cannot be secured cheaply, as is frequently the case in Canada, there are possibilities for sulphite in this direction.

Minor uses for sulphite liquor are as a sizing for paper and as a binder for briquettes. Neither of these uses has attained any commercial prominence.

The most promising use for sulphite liquor which has yet developed is the manufacture of alcohol. The principle of this is not new. Most of the constituents of wood either belong or are closely related to the group of substances so widely found in nature and chemically known as carbohydrates, of which a great many, under the influence of acids, high temperature and pressure, are changed—hydrolyzed—to grape sugar. Such conditions prevail in purifying wood by the bisulphite process, and the result is that the residual liquors contain a fair proportion of sugar. This sugar cannot be separated directly, but can be fermented into alcohol and the alcohol may be reclaimed by rectification.

The theory of this process is simple, but working it out on a commercial basis has been very difficult. The technical impediments have only been overcome within the past year or so.

One of the largest sulphite mills in Sweden has adopted this process and has built a plant for the manufacture of alcohol from all the waste liquors. This mill, situated at Skutskas, Sweden, produces almost 20,000 tons of sulphite fibre per year. The sulphite liquor for this fibre is rectified by the Ekstrom process, which requires the cooling and neutralization of the liquors for which the lime residues are used. The liquors are then filtered and fermented, and the alcohol reclaimed by distillation. No evaporation is necessary. This reduces the necessity for using fuel. The residuary liquors are quite harmless and can be run into streams without danger.

The Skeetskas pulp mill is now producing 300,000 gallons of alcohol yearly. The alcohol manufactured in this manner is similar to denatured alcohol. It is unpalatable because of being contaminated with wood spirits and other denaturing agents. This characteristic is

an advantage as it renders the alcohol available for industrial purposes only.

The minimum yield of alcohol per ton of pulp is about 15 gallons. The manufacturing cost has not been reported, but it cannot be great, otherwise it would not have been adopted by the Skeetskas plant, which is situated on the seashore and has no difficulty in disposing of waste liquors.

If this process were generally adopted in Canada there would be produced yearly from the waste sulphite liquors about 1,800,000 gallons of industrial alcohol, worth nearly \$1,000,000. If it were in general use in the United States it would result in the yearly production of about 11,000,000 gallons of alcohol, worth about \$6,000,000.

The utilization of sulphite liquor for the manufacture of alcohol, would be a great economic gain, because of the additional labor employed, because of the new source of profit, and because of the production of a new fuel supply. There would also be the great advantage of avoiding the danger which exists when rivers and streams are polluted by waste liquors.—“M.”



### MATRIX-BOARD.

These boards are extensively employed in the printing trade. Originally boards were used consisting of a number of layers of tissue paper and writing paper, and were made by employing a paste made of wheat starch mixed with precipitated chalk, magnesia or asbestos and kaolin. To-day boards specially made for the purpose are used as a rule. As a raw material, white paper shavings free from wood pulp are principally used. The board is heavily loaded with good kaolin free from sand and mica. Rosin milk and aluminium sulphate are used for sizing. The pulp must be perfectly free from knots and sand, and is worked up on the cylinder machine. The one side of the board must have a perfectly smooth, dense surface. Calendering the board is, how-

ever, impossible because care must be taken to obtain as great softness as possible. The boards must therefore be worked with a very fine felt which does not mark, and after being removed from the size-roll be so laid one on another that only the smooth sides contact one with another. After being pressed the boards are dried in the air, sorted, if necessary liberated from knots, and rubbed with powdered mica on the smooth side. Also, when packing care must be taken that the smooth sides are always placed one on another. The better the qualities of the matrix board, the sharper the impressions turn out and the more prints are to be made from one matrix. The exceedingly difficult matter in this process is that, on the one hand, the board is to be very soft and elastic, i.e., readily capable of taking impressions, and, on the other hand, the embossed board must be able to have hot lead poured upon it as frequently as possible, sometimes upwards of 40 times, without the sharpness of the impression suffering. Above all, the board may not be pressed either in the machine or subsequently. Therefore, for making these boards the ordinary cylinder machines and also the ordinary cardboard machine with an endless wire cannot be employed, but both must have various parts rebuilt for this special purpose. Further, it is to be noted that the type matter with which the matrix is impressed is not composed of steel, but of the ordinary soft type material, and that just on this account the board must be specially soft. Further, the board is not stretched on the mould, but is placed loosely on the enclosed matter, and impressed with the aid of a felt on the so-called embossing calenders.



—The important libel action in which the International Paper Company is bringing suit against the Lewiston (Maine) Journal for describing it as a trust in restraint of trade under the meaning of the Sherman Act, is still going on.

## NEW SOLVENTS FOR CELLULOSE.

Cellulose, in the form of filter paper, is soluble in concentrated aqueous solutions of certain salts, such as antimony, trichloride, stannous chloride, and zinc bromide. In solution in aqueous hydrogen chloride or hydrogen bromide, these salts and many others dissolve cellulose with great ease, as do a few salts in formic acid and in trichloroacetic acid.

It is probable that the process of solution is due to an attraction of cellulose for the metallic salt, which varies in magnitude with the degree of hydration and mechanical structure of the cellulose. This attraction results in a division of the salt between the fibre and the solution. The latter effect is only likely where a high temperature is employed, and where some agent, such as an acid, is present that can bring about union with water.

In support of this view it is found that cellulose modified by treatment with acids becomes soluble in certain reagents (e.g., a solution of calcium chloride) in which it was previously insoluble. From the acid solutions of salts in which cellulose has been dissolved, there are obtained by reprecipitation amorphous products which have marked reducing properties and are readily hydrolyzed. These products are "modified celluloses."



## THE FORESTRY ENGINEER.

By **R. O. Swezey, Civil and Forestry Engineer, Quebec City.**

As forestry engineering is just budding in Canada, there are, of course, many lumbermen and timber limit operators of the "old school" who are to some extent justified in their contempt of the scientific forester. To many heads of corporations and directors there is a vague feeling that the forestry engineer, if called to assist, with his drastic measures and recommendations, and his alarmist reports (beautiful with

technical polish) on the waste and destruction, burnt areas, etc., will so injure the credit or fair name of the company that it is better to look for other means of taking stock of the limits.

Perhaps not the least of the instinctive objections to the engineer and forester is the idea that his charges are exorbitant. In some cases, no doubt, the cost of forest surveys is excessive and altogether out of proportion to the benefit derived therefrom. But this should not be erroneously charged to the principle of scientific forestry, but rather to the individual forester's lack of experience and his ignorance of conditions and methods necessarily peculiar to this country.

There might be a tendency among forest engineers who have had no experience in this country to encumber their methods by adhering to practices of European countries, though often the methods used, even so close as in some of the northern States, would be misapplied in Quebec and Ontario, thus awkwardly increasing the cost of the survey and incidentally hurting the prestige of the scientific forester. For instance, the running of lines should not be practised too freely on large limits in remote parts; neither should contour lines be considered important as valuable data to the operating company. These two are very costly and altogether out of proportion to their usefulness. Rivers, creeks and lake shores, from which compass cruise lines are run, should take the place of expensive base lines over mountains and across river courses and other obstacles. Should a new and perfected map of the limits be required, a stadia survey of the lakes and watercourses, showing mountains, is all that is necessary.

The forest engineer's method should not differ very materially from that of the old time cruiser. If he has the required experience in this country it will not be necessary for him to use his calipers on every acre. But his method of following and examining a river valley should be so pursued that he may



see every part of the drainage area, examining it in compass strips from the shores at frequent intervals, thus classifying each and every small part.

As for contours, the engineer's notes of his observations should, as a rule, be sufficient to locate obstacles and the various degrees of incline. This incline towards a river is always more or less noticeable within its drainage area—a natural advantage, facilitating the locating of logging roads.

Taking every watercourse in this manner, a limit is quickly and economically examined. Expertness on the part of the forester in catching all essentials is, however, the best guarantee of efficiency on all points. If he cannot at a glance determine the feasibility of driving rivers, locating storage reservoirs or of placing shanties and jobbers, as well as to be able to make an accurate map of all watercourses and timber, showing the quantity and quality of the various kinds of wood; and, most important, if he cannot do all this by quick and economical methods, he had better not undertake the work, for he will surely discourage the employer by the excessive cost of the work under his charge.



### CANADA PROGRESSING.

Our esteemed contemporary of New York, the Paper Trade Journal, has this complimentary little article on the way Canada is progressing.—

Canada, not without a considerable show of reason, is inclined to plume herself just now on her industrial progression. She claims that the twentieth century belongs to her by the same right as we acquired and utilized the nineteenth. The country surely is making vast strides in the manufacture of paper as well as other things. From a Canadian authority we learn that more paper is consumed in the Dominion per capita than in the United States, Mexico or Central America, and that the progress and degree of civilization of a country should be judged by its per capita con-

sumption of paper, just as in the same way a man should be judged by the sum total of his tailor's bills. The production of paper in Canada is given as from six to nine hundred tons daily, which, when her population of, say, seven and one-half millions is taken into consideration, compares most favorably with the outturn and consumption of the United States, which is estimated by the same authority at about three thousand tons a day, allowing the latter country a population of ninety-odd millions.

Canada has been singularly blessed, and her seven and one-half millions of people have every reason to be equally proud of their own achievements and of their wealth of natural resources. They have had a practical lesson taught them on this side, and if they don't profit by it they are greater fools than anyone who knows them will allow.



—We have received a copy of the International Number of the "Paper-Maker and British Paper Trade Journal" for 1911. Embracing no fewer than 400 pages, it is by far the largest number that enterprising contemporary ever issued. The literary contents of the Journal are for the most part given in the leading European languages, and deal extensively with such topics of varied interest as the recent Turin Exhibition, with its numerous features of importance to the paper-making industry, including a full description of the fine machine shown by Herr H. Füllner, of Warmbrunn; the history and work of the great British, Continental and American firms of Pulp and Paper Makers' Engineers; the world-wide travels of Mr. S. Chas. Phillips, etc., etc. The work has been profusely illustrated from photographs taken by Mr. Phillips and others in Europe and North and South America. Supplementary features of interest and value consist of the working drawings which are given of modern paper-making machines constructed by British and Continental engineers, with detailed descriptions. It is a fine issue in every respect.



## PAPER YARN TEXTILES.

Textiles from paper have now got beyond the experimental stage, and are put on the market in a large variety of fabrics, among which are stair matings, carpets, mats, mattress cloths, toweling, braids, furniture coverings and webbing. In combination with wool paper yarns have also been made into tweeds and worsteds, and with cotton into overalls for workmen's use. It is not claimed by the makers that paper yarns will supersede the fine counts of cotton or wool, but for some purposes they will undoubtedly take their place, and by so doing will liberate a large amount of material which can be used for other purposes.

The materials which are most likely to be replaced by this new fibre are jute, cotton, hemp, and flax. It is notorious that the markets for both cotton and jute are constantly being upset by bad crops, and there is also a shortage owing to the gradually increasing consumption. The first idea of spinning paper into yarn appears to have come from China, where paper is applied to many purposes which are quite foreign to our notions of its legitimate use. For untold ages the Chinese have used strips of paper in place of twine or string, twisting them up by hand into a rough yarn whenever occasion required. They have also twisted it in place of glass for windows and lanterns, they have made umbrellas of it, and have even found in it a substitute for shoe leather.

In Europe the first patent for producing a spindle fibre from wood was taken out in 1890, and in 1895-7 M. Chaviez obtained a patent "For producing yarns from spun paper strips and a spindle for that purpose." In 1892 Türk patented the production of yarn from wood pulp, and other patents were taken out in 1901 by Leinweber and Krohn. Krohn's patent is now worked in this country.

The first yarn from wood pulp was the so-called "Licella Yarn," made at

Waldhof, near Mannheim, in Germany, but these works ceased production in 1907-8 on account of the high cost of manufacture, as well as the unsatisfactory strength of the yarn. They were, however, the pioneers of the industry, and did much to bring the possibilities of paper yarn before textile manufacturers. To-day, the best yarn made from paper is known as "Silvalin," and is manufactured under Krohn's patents. The best raw material is pine fibre made from the slow-growing white pine, which is common to Norway, Sweden, Canada, and the United States, and the wood pulp should be the finest sulphite product used for the making of paper.

Paper yarn cannot be spun direct from the pulp itself, as the material has not sufficient fibre to form a yarn of any strength. The only practical way of getting over this difficulty is to make the pulp into paper, and cut this into fine strips, from which a yarn can be spun. Finished paper gives a strong yarn, but it is not necessary to carry the process of finishing as far as for ordinary paper. The yarn can be spun from paper that is only half-made. The manufacture of yarn from finished paper was first worked in Saxony, and afterwards in Austria, the product being known as "Xylolin," which found extensive use in forming backings for carpets. Carpets were even made exclusively from this material.

In making the yarn, the paper, in rolls of about 19 in. wide, is placed in a cutting machine, which cuts the entire width in one operation, the width of the strips being from  $\frac{1}{8}$  in. upwards, according to requirements. The strips are next rolled upon bobbins, and are taken to the spinning frame, which has one spindle for each bobbin, the paper strips being damped by a roller before spinning, otherwise they could not be spun. For the strongest yarn Swedish kraft-paper has proved to be the best material, but pure sulphite paper, free

from mechanical pulp, gives a fairly strong, useful yarn, while for fine yarns tissue paper is the only one admissible. Some of the fine Japanese papers appear to be the most likely papers for making fine yarns, as they are surprisingly tough, considering their extreme tenuity.

The spinning itself is very simple. There is no fibrous dust flying about, for the surface of the paper is smooth and non-friable—an important feature in spinning of all kinds. All shades of colors are readily dyed, either on the paper before spinning or on the yarn afterwards, and the yarns can be easily impregnated with water-proofing substances, or with bodies conferring a high lustre. Some fabrics containing from 25 per cent. of paper yarn upwards are very difficult to detect from cloths made from cotton, jute, or hemp, and where a smooth yarn, free from projecting hairs, is required, these paper products are very suitable. As regards fireproof qualities, paper is a ready absorbent of such chemicals as sodium phosphate, tungstate of soda, etc. The addition of these substances makes no difference to the appearance of the yarn, and, if necessary, they could be introduced when the paper is damped before spinning.

As it comes from the spindle, paper yarn may be used for packing twine and spindle cord, and when woven into cloths it makes good saddle-bags for furniture. These saddle-bags are much cheaper than those made from hemp, and for some reasons superior. For the backing of carpets paper yarn is a better article than jute, and for this purpose alone it has an extensive use on the Continent. For such purposes as tarpaulins, scenery cloths, paddings, and water-proof canvas, paper can be used either alone or with a warp of cotton or jute, and it appears to be particularly well adapted for making wool sheets.

Anyone who is conversant with the wool trade knows the damage and trouble caused by fibres of hemp or jute

getting into the contents of the pack, where they are not in evidence until the wool is dyed. Their first visible appearance is often in the woven fabric, where carbonizing is impossible owing to the cotton lists, and it is next to impossible to cover them with any dye. Another claim which paper yarn has for suitability for the making of wool sheets is that it cannot be disintegrated into fibre like a yarn of jute or hemp. If it is broken, it simply comes away in small pieces, having practically no length, which makes it difficult for it to blend with other fibres in spinning. Trimmings of all kinds for curtains and furniture also offer a field for this material, either alone or in combination with other fibres to impart suppleness and elasticity, and it has even formed a background for silk goods, where all the silk threads appear on the face.

The most important future for these paper yarns appears to be as a substitute for jute in the making of sacks and bags of all kinds, as well as a foundation for oilcloths and linoleums of many descriptions. As the yearly demand for jute is increasing, and there appears little likelihood of the crops being increased in proportion to the wants, the paper substitute should commend itself to the makers of canvas and bagging cloths for all purposes. So far as fine counts in cotton goods are concerned, pine fibre yarn will not be a competitor, nor will it oust the wool fibre from either worsteds or woolens. Wool has a spring and handle peculiar to itself, which will never be reproduced in any substitute, but for a strong, cheap, and durable yarn paper has an important future.

Compared with other yarns its cost is much less, and if the consumption is large the price will be reduced in proportion to the output. A strong point in favor of paper yarn is its resistance to water either hot or cold, and it has very little tendency to rot when kept in a damp state. There appears to be room for its employment in the making of machine belting in place of the

rather costly cotton and balata which are now used, and it might also replace the so-called camel-hair belts, which are in extensive use everywhere.

Engine packings, where a woven yarn is impregnated with lubricating matter, should also offer some outlet for this interesting product, not to mention such uses as rings for packing the joints of steam pipes where rubber is likely to blow out. As a non-conductor of heat paper takes first rank, and it should, therefore, figure in the manufacture of quilts and bed-covering generally, for which its light weight is also another recommendation, and the same properties would render its use for motor garments feasible. A final suggestion is the use of brightly-colored paper checking threads in such cloths as tweeds and fancy mixtures, where something striking is required to bring out the character of the cloth.



#### EXPORT MARKET FOR PAPER.

In a recent letter Elder Dempster & Co., shippers, Montreal, discuss the possibilities of developing an export trade in paper and its manufacture with South Africa.

It is difficult to understand why we should not be able to practically control the trade in paper bags, for while Great Britain does not produce a pound of pulp, she is able to supply three-quarters of the imports of this commodity. The greater portion of the balance is shipped from the United States.

We are now endeavoring to interest shippers in paper bags, and we expect to have some small sample shipments in January, which we believe will lead to some business being done. As this is a substantial item, it is hoped that factories producing paper bags in the Dominion will be sufficiently interested in this letter to write for further information, which we will cheerfully give.

The same remarks apply to wrapping paper. The figures for wrapping paper, added to those of paper bags, make a total of over £79,000, a very considerable sum and one Canadian manufacturers cannot afford to neglect.

The demand for wallpaper is for rolls made up in English sizes, namely 21-inch by 36 feet. The Canadian and United States sizes are 18-inch by 48-feet. In spite of the great length, it is very difficult for dealers to obtain a higher price for the United States article than the British, the people being accustomed to a certain size and price. Another argument urged against the United States make is that being narrower, it requires more labor to hang it.

As the trade in wallpaper is of some importance, and is likely to increase, it does seem strange that we have not yet been successful in our efforts to interest the manufacturers here; possibly because they do not apparently care to conform to the English size. We are reliably informed that Canadian patterns are very much finer, and more pleasing to the eye than the British, and we therefore hope our manufacturers will go after this trade in an aggressive manner.

The bulk of the trade in printing paper for newspaper work is controlled by Canadian mills, and we understand this paper gives excellent satisfaction. The shipments are controlled by the large mills who know more about the trade, possibly, than we do ourselves, therefore, it is not at all necessary for us to go into details.

We shall be glad if the manufacturers of paper bags and wallpapers will write us for rates and other information, because we certainly feel that Canadian manufacturers should get a share of the trade that is being done. We will be pleased to assist them to get into the South African market, and will be glad to place them in touch with reliable firms through whom their product might be sold.

### NEW INCORPORATIONS.

St. George Pulp and Paper Company, Limited, St. George, N.B., capital \$460,000. To acquire and construct pulp and paper mills or any product of which they are component parts. Jos. Goodfellow, Fort Edward, N.Y.; Elijah W. Murphy, of Syracuse, N.Y.; A. C. Getten, Hudson Falls, N.Y., and E. G. Murphy, of Norwalk, Conn.

Arnprior Box Company, Limited, Arnprior, Ontario; capital, \$40,000. To manufacture and deal in wood pulp, fibre-board, paper, boxes, and other manufactures of wood, paper pulp and fibre-board. D. McLachlin, T. S. Church, and W. A. Whyte, of Arnprior, Ont.

R. Lockhart & Company, Ltd., Fort Frances, Ont. To carry on business as lumbermen, manufacture and sell pulp and paper. Richard Lockhart, Fort Frances; and Allen G. Leaman, of Port Arthur, Ont.

Enterprise Chemical Company, Ltd., Montreal; capital, \$100,000. To manufacture wood pulp, paper, dyes, etc. N. A. Ostigney, Valleyfield, Que.; E. A. Schmidt, and G. Boulanger, of Montreal.

Canadian Art Works, Ltd., Montreal; capital, \$10,000. To carry on business as printers and bookbinders, manufacture show-cards, calendars, etc., deal in paper cardboard, celluloid, etc. H. S. Stevens, advocate; J. L. Reay, accountant; and M. L. Nagle, of Montreal.

Argenteuil Granite Co., Ltd., Montreal; capital, \$250,000. To manufacture and deal in lumber and pulp, etc. G. Archd. Campbell, advocate, Montreal.

Western Box and Shingle Mills, Ltd., Nelson, B.C. To run saw and pulp mills, etc.

Consolidated Pulp and Paper Co., Ltd., Lancaster, N.B.; capital, \$5,000,000. To operate pulp and paper, and lumber mills, develop lands, etc. N. M. Jones, Bangor, Me.; Hon. Robt. Mackay, Montreal; T. McAvity, A. H. Hanington, H. W. Schofield, and C. S. Hanington, all of St. John, N.B.

Saraguay Mills, Ltd., Montreal; capital, \$20,000. To operate sawmills, own timber limits, and deal in lumber and its products. J. S. and W. G. M. Morgan, of Sorel, Que.; E. A. D. Morgan, E. Mauralt, and P. Gouëvremont, Montreal.



### ACTION OF LIME ON SULPHITE PULP WASTE LYE.

If sulphite waste lye be treated with milk of lye until neutralized, a precipitate is formed containing calcium sulphate, calcium sulphite and calcium salts of organic acids. If more lime be added, the precipitate is increased and the liquid assumes a yellowish color. On filtering the liquid and adding a further quantity of lime, it is found that a considerable portion of the latter is dissolved. If the yellow lye be then heated, or if more milk of lime be added, a large quantity of a yellow precipitate is suddenly produced and the entire mass forms a thick paste. The liquid portion can be separated by filtration and the precipitate then appears to be composed of very small crystals of the calcium salts or salts of one or several very similar organic compounds. The moist precipitate readily dissolves when acidified with sulphuric acid; when it is decomposed, calcium sulphate separates out and a yellow or brown solution remains. If this be poured slowly into sulphuric acid of 30 degrees Bé., while stirring, each drop congeals at once to a flaky gray mass, so that a large quantity of an organic substance is obtained, which can be filtered off from the excess of acid. This organic substance when oxidized by nitric acid yields quantities or crystals of oxalic acid.



—Great interest is being taken in the annual convention of the American Paper and Pulp Association, which takes place at the Waldorf-Astoria, New York City, this week. According to all reports the attendance will be much in excess of any previous year.



## SOCIETY OF CELLULOSE AND PAPER CHEMISTS.

(Concluded from last issue.)

Herr Krawany was of the opinion that the prices of rosin, which in the course of fifteen years have risen from 18-8½ M. to about 30 M., will rise still further if a substitute is not procured in large quantities. Trials with Grecian rosin have not given him satisfaction. The rosin is impure, and contains up to 50 per cent. non-saponifiable matter. When treating this rosin with alkali the non-saponifiable matter remains behind as a kind of sponge or skeleton. By their content of colloids many of the "rosin-size substitutes" on the market readily become emulsifiable (at 30-50 degrees), or, indeed, "soluble in the hollander-engine"; i. e., they can be put directly into the hollander engine. The colloids act as a kind of partition, preventing the particles of rosin melting together. Special importance accrues to the dilution of rosin-size in rosin-milk. The endeavors to make use of sulphite waste liquors on a large scale for sizing have as yet (apart from the Mitscherlich's tan sizing) scarcely met with success.

Dr. Wurster stated he had proved in 1875 that the dilution of rosin-size plays an exceedingly large part. The cause is due to continuous dissociation, which increases with the degree of dilution.

The temperature and the storage of the rosin milk also have a great influence. The dilution can be driven so far that all the rosin is finally present in a free form. These observations directly contradict the results arrived at in a recent publication by J. Stewart Remington, who considers the aluminium resinate an operative constituent of rosin-sizing. Remington's assertion that aluminium resinate is split by ether into its constituents is disproved by his having dissolved resinate of alumina which had been twenty years in stock in ether without splitting taking place.

An examination of Remington's works by the Society would be desirable, and

would without doubt confirm the untenableness of the conclusions drawn by him.

Dr. Klemm has been able to observe crystallization processes in various rosin sizes, particularly in those having a solid state. When the crystallization took place rapidly the mass became turbid, and when slowly cavities formed; by melting, an amorphous mass is again obtained. The formation of crystals can be produced artificially by changing the temperature. Particularly French rosin shows this, because the pimic acid, the principal constituent of French rosin, crystallizes relatively readily. There appears to be a connection between the tendency to crystallization and the proportion of a rosin soap insoluble in petrol-ether. By melting for a long time this portion is diminished and the power of crystallization is simultaneously diminished. The amount of matter insoluble in petrol-ether is, moreover, neither fixed nor characteristic of definite kinds. In connection with the above-mentioned question of moist heating Dr. Klemm further remarked that a temperature of 120 to 130 degs. when drying the paper could not come into question. Even if fibres and precipitated rosin are heated together at 100 degs., a considerable rise in temperature rapidly occurs until carbonization or spontaneous combustion occurs, particularly on passing air through. This is a proof for the injurious action of dry heating, as is still frequently the case, particularly on the last cylinders.

Dr. Klemm then stated that one must distinguish between whether a paper is to be fast for ink or other liquids. The resins of the earth alkalis, e. g., are very suitable for giving paper a certain fastness against water. The resins of the earth-alkalis are split by ink, which always contains a certain percentage of acid (up to 0.7 per cent.). The conditions for forming resins are not fulfilled in the mode in which rosin-sizing is generally carried out. Even when a neutral resinate of soda



is brought together, with dissolved aluminium sulphate, no pure aluminium resinate is obtained when—as is always the case—sulphate of alumina is employed in excess. The precipitate produced during the rosin-sizing can be moistened at first with water, but not after being dried. Also, the alumina compounds are changed by the action of the heat. The successes of moist heating cannot be disputed. One consequence of dry superheating is, amongst others, the sensitiveness of the paper to mechanical strain, which is felt by the paper partially losing its sizing, when being calendered, for example. Direct fraud is in part practised with rosin substitutes. For these purposes almost all colloids, e.g., animal glue, casein, gluten, protein and starch have been employed. The percentage of rosin in these substitutes in part goes down to 28 per cent., and the percentage of dry matter to 31 per cent. Manufacturers of rosin size who are of good standing have to suffer in consequence.

The doubt whether the rosin obtained by extraction from wood is able to size sufficiently is not considered established by Herr Willy Schacht. It is an old experience that mechanical wood pulp ground very wet, such as is produced when employing 10 bis 12 h.p. per day on 100 kilogs. pulp, yields a perfectly sized paper. This proves that the rosin in the wood is able to size perfectly.

Dr. Klein proposes to collect samples of various rosin sizes to examine them, to debit the Society with the costs, and to make the results of the investigations accessible only to members.



#### WETTING IN CALENDERING.

The improvement in the appearance of paper effected by calendering has long been recognized. Now it is important that the paper to be calendered should be just right in respect of the amount of moisture in it. If it contains too little it will not glaze any more than a perfectly dry fabric will smooth under the

flat-iron. If it is too damp it will pass away from the calender before the moisture has been reduced to the proper point.

To carry out our simile, we may recall that really wet fabrics cannot be ironed. Calendering and ironing are processes very closely allied. As the paper leaves the dry end of the Fourdrinier with an insufficient amount of moisture for proper calendering, special machinery has been invented for cooling it and at the same time damping it to just the proper degree. Although the paper is not yet quite cold after one damping it is ready for calendering, provided it is not more than one hundred grammes per square metre. For heavier papers more damping, i.e., further passages through the machine are required.

The use of the damping machine may entail several difficulties. The paper may be torn, as it is weaker when damp, and when the paper is rolled up it often happens that it is rolled too loosely and irregularly. These difficulties are accentuated when, as above stated may be the case, damping has to be repeated, as that means that the paper has to be kept damp for a longer time before calendering.

The remedy seems to be to damp before the paper leaves the Fourdrinier, and not to do so by means of a special machine afterwards. It is quite easy to supplement the dry end with a cold cylinder of large dimensions, so that the dry paper is quickly cooled, and with a damping arrangement placed between the cooling cylinder and the reels. The damping arrangement consists merely of a wet revolving brush. The nature of the brush and the supply of water to it must, of course, be such that the damping of the paper is just so. The preliminary cooling of the paper is of great importance, as experience has shown that it is a very effectual preventive of creasing under the calender, probably because paper still hot from the dry end would be unequally damped by the brush.

## TRADE AND MANUFACTURERS' NOTES

### MACHINERY FOR PAPER MILLS.

In a recent issue of the London Times Engineering Supplement appears the following:—

Remarkable progress has been made by papermakers' engineers in improving the machinery in use in paper mills. Trade is exceptionally good in this branch of engineering, and has been so for the past year or more, orders being plentiful, not only for the home mills, but also for foreign manufacturers. The export trade to all parts of the world from this country is a very important one. Keen competition has, however, to be faced from Continental and American engineers, who vie with each other in perfecting appliances and introducing new inventions. Particularly are the German firms on the outlook for orders; one large German concern had not long ago no fewer than 20 complete paper and cardboard making machines in various stages of construction at one time. Of these 12 were for German mills, two for Austria, two for Norway, two for Russia, one for Sweden, and one for Switzerland. Six of these machines were for a working width of over 9 ft.

A great advance is noted in the speed of "news" machines, and several recently erected in this country can work up to 650 ft. or even 700 ft. a minute, turning out finished paper. To attain this high speed many improvements have been effected in the various parts of the mechanism. Special attention is being given by papermakers to the introduction of the suction roll. The idea is not a new one, but the latest patents have brought the roll into practical use. The Millspaugh suction roll, the invention of W. H. Millspaugh, of Ohio, U.S.A., is now being adopted in this country, and two of the largest engineering firms, Messrs. Bertrams, Ltd., of St. Katherine Works, Edinburgh, and Messrs.

Bentley & Jackson, Ltd., of Bury, are introducing it with success. The Margault vacuum roll has also met with acceptance; it is supplied by an old established Edinburgh firm, Messrs. James Milne & Son, Ltd. Many of the patents have for their object the more economical working of one or other of the numerous appliances in mills. For example, one new patent is a "save-all" for use in recovering pulp and other materials from the water discharged from papermaking machines; while another is for manufacturing an art or coated paper which is in itself adhesive, thus dispensing with their separate and distinct process of gumming and pasting.

Charles Walmsley & Co., Ltd., of Bury, built recently for the Sittingbourne Mills, two machines capable of making a high-class web of news paper on a wire of 175-in. wide and running at the fast speed of 650 ft. a minute. This is an extreme width, although the firm have lately constructed a machine for the Imperial Mills, Gravesend, with a width of 160 in. The latter has 30 drying cylinders, each 5 ft. in diameter, while the finishing calenders have 10 chilled iron rolls, each roll fitted with self-feedign doctors and cooling arrangements. Messrs. Bertrams supplied recently a machine 134 in. wide to mills at Dartford, and Messrs. James Milne & Son sent a large machine with a wire 166 in. wide to a manufactory in Sweden. Only a few months ago a rubber company in Edinburgh covered rolls for Messrs. Walmsley which are understood to be the largest press roll yet made in this or any other country. Each roll is 30 in. in diameter and 225 in. over all, and weighs fully six tons.

In competing for work abroad British engineers are very successful. Japan is directing her attention to papermaking, and to encourage the Japanese makers the tariff was increased from July 1st

last on certain classes of imported paper. Last year the whole plant for a mill to manufacture book and news paper was shipped to Japan by Messrs. James Bertram & Sons, of Leith-walk, Edinburgh. This new mill at Tomakamai contains five machines of large size. That Edinburgh firm last year also erected a mill at Tonkin for the manufacture of air-dry pulp from bamboo. Messrs. Milne, Edinburgh, supplied complete papermaking plant to a Spanish factory; and Messrs. Bertrams erected a fine machine in Canada with a wire 136-in. wide, and 19 4-ft. cylinders. China is wakening up in the papermaking industry, and at present an American firm of engineers, Messrs. John Horne & Sons, of Lawrence, Mass., are setting up two plants to enable native workers to produce cheap grades of paper suitable for newspaper and book work, one at Canton, and one at Peking. These mills will utilize bamboo, rich straw, and mountain grass. On the continent, in America, and in the colonies the English and the Scottish firms are well known, and some of the fastest machines now working were from this country.

Such firms as the above have numerous patents for machines and appliances in connection with the manufacture of paper which have found favor with papermakers in all parts of the world. These comprehend beaters, cutters, refiners, pulp-savers, spray-dampers, rag-cutters, strainers, vibrating frames, kneaders, concentrators, hydraulic presses, rag and straw boilers, caustic pans, pulpers, ejectors, sizing machines, felt rolls, wires, rag and straw boilers, water pumping and softening plants, and many others. In Germany many of the large paper mills have their own steam grinders for converting wood into pulp. In place, therefore, of buying the pulp from the pulp-maker, they get the wood. One of these grinders made by a German firm of engineers is so designed that the logs of wood are placed into it at night, and in the morning hot pulp is ready for the mill. It is claimed that

economy is effected by the grinder, but papermakers in the United Kingdom have not yet adopted this method of obtaining the raw material.

While steam power has held its own in mills ever since it superseded the water-wheel, electric installations are now coming into favor. One Scottish papermaking company last year spent £15,000 in the electrification of the factory. In the new Japanese factory at Tomakamai, although the five papermaking machines are driven by steam, all the other power is electric. The mill has an electric power house of 15,000 horse-power, and there are 56 electric motors. For the greatly increased rate of speed of paper machines the electric drive is helpful. There was difficulty at first in securing with electrical power a sufficient variation of speed from the fastest rate down to the slow travelling necessary for wire washing, felt changing, etc., particularly when different sorts of paper had to be made on the same machine. The methods now in use allow of every conceivable variation being produced without waste of current. As the motor gives the changes through variation of the current all expensive speed-changing gear is dispensed with, and this alone saves money in first cost and in upkeep.

The majority of new mills now being erected at home or abroad utilize electric power. If the manufactory is near a central power station, it may be found advantageous to purchase the necessary power from the Supply Company. Usually, however, it is the case that papermakers find it desirable to own their own plant and to generate current for themselves. As steam is required for heating purposes in the manufacture of paper, a boiler is essential. The use of the steam turbine in place of the reciprocating engine is, however, being recommended. Apart from the economical working of the turbine, there is the great advantage of obtaining a large quantity of exhaust steam free from oil, which is a drawback in utilizing the exhaust steam of the reciprocating engine.

Among the British engineering concerns which specialize in the making of turbo-generating sets, one has during the past few years carried out electric installations in paper mills in this and other countries, amounting to an aggregate of over 109,100 horse-power, the largest individual plant being one of 30,837 horse-power. Papermakers who have reorganized their factories, and have had them electrically equipped, have found that resulting economies and better conditions of work made a welcome difference in the year's balance-sheet.



### TOWNSEND CELL AND PROCESS.

The Hooker Electrochemical Company has in operation at its Niagara Falls, N.Y., plant the Townsend Electrolytic Cell and Process for the production of caustic soda and chlorine from common salt and of caustic potash and chlorine from potassium chloride. Operation has taken place on a large and increasing commercial scale ever since January 1st, 1906, the manufactured products being caustic soda and bleaching powder for the general market. The Townsend cell is a diaphragm cell of vertical type operated by a process which permits to an important degree the immediate removal of the caustic upon its formation in the cathode chamber thereby preventing recombination with the solution in the cell and allowing very complete electrolytic action and with high current density. The construction is simple and designed for large units; a 5,000 ampere cell is for its size, 13' x 4½' x 1½', a powerful electric machine, capable of developing 30 horse-power. Yet, an installation of 80 such units, equal to 2,400 horse-power, would require the constant attention of only one average workman. A single 5,000 ampere unit can produce in a year 63 tons of caustic soda and 144 tons of bleaching powder, with an average market value of \$6,186.

### SHERBROOKE MACHINERY CO., LIMITED.

The Brompton Pulp and Paper Company, of East Angus, Que., have placed an order with the Sherbrooke Machinery Co., Limited, for five "Extra Heavy Design" two-roll wet machines, this being the second order, as their original installation was ten of the same design machines.

The Sherbrooke firm have recently shipped complete pneumatic save-all equipment to the Spanish River Pulp and Paper Mills, Limited, Espanola, Ont., this being a battery design; also a complete pneumatic save-all equipment, battery design, to the mill of the Lake Superior Paper Company, Sault Ste. Marie, Ont.

The Sherbrooke Machinery Co., Ltd., have also supplied the East Canada Power and Pulp Company, Murray Bay, Que., with a complete equipment of wet machines for their new mill, consisting of fourteen of our "Extra Heavy Design" two-roll wet machines. They also furnished this company with a complete pneumatic save-all equipment, as well as pneumatic water filters. They also furnished the new mill of the Union Bag and Paper Company at Cap Magdeleine, Que., with ten "Extra Heavy Design" two-roll wet machines.



### UNION SULPHUR CO.

The Union Sulphur Company has moved its general New York office to the Whitehall Building, No. 17 Battery Place, New York City. It is interesting to record that the Perkin medal for distinguished service in the field of applied chemistry was recently presented to Herman Frasch of the above company. His remarkable achievements in the realm of the mechanical and scientific removal of obstacles in the way of raising sulphur from the Louisiana wells read like a romance, but they show the remarkable intelligence and pertinacity of the man.



The Public Service Company, Bush Terminal, South Brooklyn, N.Y., which aims to manufacture paper cups as a result of the recent ordinance passed by some United States cities forbidding the use of common drinking vessels, has elected Henry Hias president. He is connected with the Continental Paper Bag Company, which has a branch at Ottawa.

\* \* \*

The Sandy Hill Iron and Brass Works, Hudson Falls, N.Y., favor us with one of their unique cards illustrating the Parker Open-side Screen, of which 808 were sold in two and a half years.



### QUEBEC NOTES.

(Special to "Pulp and Paper Magazine.")

Quebec City, Feb. 9th, 1912.

The Chicoutimi Pulp Company, Chicoutimi, are enlarging their lower pulp mill to operate twelve new grinders. This will be completed next July when the daily output of these mills will be 300 tons. A water-power of 4,000 horse-power is being developed on the Chicoutimi River above the pulp mills. This will be used by the municipality of Chicoutimi, thus releasing to the pulp company for their own use the power they are now supplying to the town.

Four new grinders are being installed for the Quiatchouan Pulp Co., Lake St. John.

Price Bros. & Co. are developing a large water-power on the Shipshaw, to be transmitted a short distance of a few miles to their large new plant at Jonquièrre on the opposite side of the Saguenay.

The East Canada Pulp Co., endeavoring to increase their water-power and log-driving facilities by creating storage on the upper stretches of the Malbaie River, are meeting with stubborn resist-

ance by the Laurentide National Park authorities, who claim that storage in the park will destroy the game, while the trespassing may start fires. Local comment on such objections is very severe, since storage is so obviously an important part of the conservation policy to which the whole nation has committed itself.

Recent comments by Mr. R. O. Swezey C.E., forest engineer, Quebec, show that the spruce bud worm continues to destroy large tracts of balsam pulpwood and timber, which forms a large percentage of the Laurentian slopes. The spruce so far shows very little sign of having been damaged.



### USE OF WASTE WOOD.

Grind into pulp, with the aid of a cheap grinder, or the installation of a grinding box, as near as possible to the upper edge of the stone, which can be filled with the waste. The so-called "sauer-kraut" can be reduced in a suitable fibre machine to coarse wood pulp, which after passing through the refiner can be used for making paper and pasteboard. The "sauer-kraut" can also be reduced to fibre in the edge mill, but the result is disproportionately small, compared with the expenditure of power and time. In warm weather, with suitable wind, the refuse may be dried for use as fuel under the boilers, and must be spread about to insure the proper drying.



### SULPHITE TANNING LIQUORS.

The literature relating to the utilization of sulphite waste liquor is now fairly extensive, and, although no products have been obtained which have any considerable extended application, yet some progress has been made toward the man-



ufacture of industrial products, says R. W. Sindall in Paper Making.

One interesting instance of this is to be found in the production of a solution claimed to be suitable for tanning leather. The material obtained, however, cannot be regarded as more than an adulterant, its virtues as a tanning material being based chiefly on the fact that it contains a considerable proportion of material absorbed by hide.

The organic material in the waste liquor has a complex composition, but expressed in common terms, the quantity of material in the sulphite liquor per ton of pulp may be taken as

	Pounds.
Organic matter in wood .....	2,000
Sulphate of lime .....	449
Sulphurous acid .....	18
Combined sulphuric acid .....	196
—	
Total .....	2,663

The so-called tanning material obtained from waste sulphite liquor is produced by treating the liquor with aluminum or chromium sesquioxide, together with an acid capable of precipitating the mineral matter from the liquor itself and removing the precipitate formed by the salts of aluminum or chromium. The clear liquid on standing deposits a second precipitate, mainly sulphur, which is also removed. The clear filtrate is then concentrated or evaporated as required to a thick syrup, or, if necessary, to a dry product. This consists of a soluble compound of the sesquioxide of aluminum or chromium with the practically unchanged organic matters in the sulphite liquor.

The new tanning liquor produced has approximately a density of  $31^{\circ}$ - $32^{\circ}$  Beaumé (specific gravity 1.275-1.285). The approximate analysis is:

	Per Cent.
Tannin matters .....	22
Soluble non-tannin matters .....	32

Insoluble non-tannin matters .....	2
Water .....	44
—	
	100

On ignition the percentage of ash varies from 4 per cent. to 8 per cent., according to the nature of the inorganic salts employed in treatment of the waste liquors.

The virtues of this product as a tanning material are based on the fact that the proportion of tannin, which is the material absorbed by hide powder, amounts to 22 per cent.

The product is usually employed in varying proportions with ordinary tanning liquors, and on this account it is important to have some method of determining the presence of the liquors in conjunction with the tanning extracts.

The concentrated sulphite liquors give a product which by the above treatment resembles oak wood extract in appearance, and on analysis by the authorized method of the Association of Leather Trade Chemists how about 22 per cent. of tannin, as already exemplified.

When used alone it produces inferior leather, but it can be used in conjunction with other extracts up to a certain extent without any radical difference, of appearance at least, being noticed.

At present no reliable method is known for the determination of the proportion of the wood pulp extract which may be mixed with other extracts. The actual presence of the material may be determined by a simple test as follows:

"0.5 cc. of aniline is added to 5 cc. of the solution of suspected extract. A turbid emulsion is produced, which disappears with the addition of 2 cc. of strong hydrochloric acid in the case of genuine extracts.

"In the presence of wood pulp extract the precipitate is not dissolved on the addition of the hydrochloric acid. The extent of turbidity is some measure of proportion of wood pulp extract present in the solution examined."

## CANADIAN FORESTRY ASSOCIATION.

The annual meeting of the Canadian Forestry Association was held at Ottawa on the 7th and 8th inst., with the largest and most enthusiastic attendance in the history of the organization, over 200 being in attendance at the opening session.

Geo. Y. Chown, of Kingston, president, occupied the chair.

Rt. Hon. R. L. Borden, Prime Minister, in opening the meeting, emphasized the importance of the forest resources of the country. Canada, like a young man, just starting out in life, had come into the possession of vast resources, but supervision was needed if these great assets were not to be wasted. "The Commission of Conservation is for that purpose, and it is preserving our forests for future days. We are apt to forget posterity in a young and growing country, but in that respect we must exercise care and remember those who are growing up and those who are not yet born. In some countries the land has been surveyed for agricultural purposes, and as the result of those surveys farmers are able to ascertain what product will bring the best results from their land. I believe that our forests would be much more valuable if the forests had been better preserved." Premier Borden stated that at the last convention he was greatly impressed by the statement that more forest was destroyed by fire than by the lumbermen. He urged the Forestry Association, therefore, to impress both legislators and people with the necessity of checking the evils of fires.

Sir Wilfrid Laurier supported the Premier in his views, and said that the forest had three chief enemies; the prospector, the settler, and the railway. He approved of the Premier's suggestion that there should be a survey of the forest areas of Canada.

President Chown in his address, held that the association had aroused public opinion and must now bring that opinion to bear in a forward movement. The

things for which the association should work were (1) the taking of the forestry services, both Dominion and Provincial, out of politics, making way for technically trained men; (2) a permanent forest policy, and especially a progressive policy with regard to the treatment of forest reserves; (3) some efficient manner of dealing with slash in order to guard against forest fires.

Venerable Archdeacon Robert J. Renison, of Moose Factory, said the forestry department had been sending out as fire rangers men who don't know the difference between a frying pan and a paddle. He was not opposed to university students as fire rangers, but he was pleading the cause of the Indian. "We have in the north land hundreds and hundreds of Indians, whom I consider an asset to the country. I hope the Dominion and the provinces will use the Indian in his natural environment."

Mr. E. Stewart, formerly Dominion Superintendent of Forestry, agreed.

R. H. Campbell, Dominion Superintendent of Forestry, said that at the north end of Lake Winnipeg arrangements had already been made to employ the Indians as fire rangers, and that their use would probably be extended.

In regard to college students as fire rangers, Aubrey White, Deputy-Minister of Lands and Forests for Ontario, said that on the whole, they had not given poor service. An educated man of 22 was better for the purpose than an unintelligent lumber jack. The Crown Lands Department intended no exclusion of students so long as they were otherwise qualified, but they intended to show no favor to any special class of men.

As to the work of Indians in forestry service, they certainly had a knowledge of woodcraft, but they lacked the continuity of purpose, the self-restraint and sense of responsibility needed for this work, and, while good as aids, they would never take the place of the white man.

Ellwood Wilson, of Shawinigan Falls, said that the difficulty with fire rangers was on the one hand that they were directly responsible to no one, and were not dismissed as they would be for inefficiency in work for a private concern, and on the other, that sufficient help was not given by the Government toward making prosecutions.

Alex. MacLaurin, Montreal, said he was very glad the railways were going to be made responsible for the damage they did to forests.

"We spend more money in fighting fires than probably all the corporations in the Dominion of Canada," said N. Stewart Dunlop, claims agent, eastern division Canadian Pacific Railway.

Hon. W. A. Charlton, ex-Minister of Crown Lands of Ontario, said that in the Province of Ontario during the last 40 years there has been more timber destroyed by fire than has been cut. He advocated a system of dividing the country into districts, each district under the charge of a competent woodsman.

Mr. Gifford Pinchot, president of the American Conservation Association, said that there was no hope of an efficient fire fighting organization while the rangers continued to be appointed for political reason and without an examination.

"A Progressive Forest Policy Requires an Investment of Capital," was the subject dealt with in a very valuable paper by H. R. McMillan, M.F., forestry branch, Department of the Interior. Forestry is really only begun when non-agricultural lands are set aside as forest reserves. It has been proven through centuries of forest management that the financial return per acre is in direct ratio to the amount spent in protection and management of the crop. This is exemplified by Prussia which in 1880 spent \$1.09 per acre in forest management and derived a net revenue of 92 cents; and which spent \$1.54 per acre in 1902 and reaped a net return of \$1.66 per acre. Canada should be encouraged in her investments in this field by the history of similar investments in Germany, France

and British India. The expenditure per year per acre is: Prussia, \$1.90; France, 9 cents; British India, 6 cents. Canada does not yet spend one cent. per acre on her forest reserves.

After dealing with methods of cutting and logging Mr. McMillan urged that experiments should be made in the utilization of sawmill waste and other waste, in the possible extension of the pulp industry, and in fact everything to make the forests more productive and forest products more valuable. Throughout it all this fact must not be overlooked, that money intelligently put into forestry is not spent but is invested for future revenue.

The committee on forest fire laws, of which Dr. B. E. Fernow, Dean of Forestry of Toronto University, was chairman, reported that they had collected all existing forestry legislation in Canada and the United States and had also gathered opinions from competent persons. Taking all things into account, they considered the laws of Nova Scotia were probably the most efficient, but the best laws to be effective must be backed by public opinion. First among the causes of forest fires is the railway. Improved equipment of locomotives and better methods of cleaning the right-of-way were the first essentials. The settler, the prospector, and the sportsman, were the next chief causes of forest fires. These should not be allowed to start fires for any purpose in the woods without a permit from the proper officer. Careless lumbering operations were also a serious cause of fires.

At the second day's meeting the address of Gifford Pinchot, chief of the Forest Service of the United States and president of the American Conservation Commission, was the first event, and the address was listened to with the closest attention by an audience which completely filled the Railway Committee room of the House of Commons. Mr. Pinchot is known as an organizer as well as a deep student of forestry problems, and he showed what remarkable results had been achieved in his special

sphere of work by evoking in men a love of service and a sense of higher responsibility, and ceasing to treat them as mere machines or automatons.

Other instructive addresses were by E. A. Sterling, Forester, Pennsylvania Railroad Company, on "The Attitude of Railroads towards Forest Fires," and by E. Stewart, late head of the Canadian Forest Service, on "The Aims and Objects of the Canadian Forestry Association"; Hon. Martin Burrell, Minister of Agriculture; C. C. James, Deputy Minister of Agriculture of Ontario; R. H. Campbell, superintendent of the Forestry Branch at the Department of the Interior.

The investment required in a progressive forest policy was the topic of an interesting address by H. R. McMillan, of the Canadian forestry service.

Mr. McMillan said that the Riding Mountain Forest Reserve in Manitoba contains 982,000 acres. If this were managed as are the average State forests of Germany (producing 58½ cubic feet of timber per acre per year) it would produce 57,000,000 cubic feet, or 250,000,000 board feet of timber each year. This would mean that this one reserve would produce sufficient timber to supply in perpetuity the sawmills of Ottawa and Hull, and yet leave wood for thousands of settlers. Similarly, if properly handled, the forest reserve set apart last year on the eastern slope of the Rocky Mountains would produce yearly more timber than is manufactured in the two great timber Provinces of British Columbia and Ontario. This reserve would supply one-half of Canada's timber trade and be none the worse. It has been proven through centuries of forest management that the financial return per acre is in direct ratio to the amount spent in protection and management of the crop.

The Committee on Resolutions reported, advising larger appropriations from both federal and provincial governments towards forest management in Canada, deprecating the fact that less than a cent an acre was now expended

on forest lands against \$1.90 on the average in other countries.

The committee also urged on the federal and provincial governments the necessity for providing a system of examinations to test the qualifications of appointees and of making appointments permanent during good behavior, and that the Federal Government appointments for this purpose should be placed in the hands of the Civil Service Commission.

It was resolved to impress upon the government the necessity of maintaining in connection with the forestry branch an experimental laboratory for testing and investigating the physical and mechanical properties of Canadian woods with a view to extending the possibilities of their use and for other purposes.

The association deprecated the practice of exporting in large quantities Christmas trees of spruce and balsam, and recommended legislation to prevent that practice.

An Executive Committee to meet every three months was appointed as follows: The president, the vice-president, and the Hon. Sydney Fisher, and Messrs. Gordon C. Edwards, R. H. Campbell, G. Y. Chown, and Dr. B. E. Fernow.

The association reaffirmed its attitude in favor of the inspection of the public domain and the inclusion in forest reserves of lands unsuitable for agriculture, or where the forests are required for the protection of watersheds, and urged on the federal and provincial governments the carrying out of such a policy at the earliest possible date.

The treasurer's report showed an expenditure of over six thousand dollars, and a balance on hand of over fifteen hundred dollars. The fees from members for the year amounted to over two thousand dollars.

The officers elected were as follows: Honorary past president, Sir Wilfrid Laurier; honorary president, Rt. Hon. R. L. Borden; patron, His Royal Highness the Governor-General; president



John Hendry, Vancouver; vice-president, Hon. W. A. Charlton, M.P., Toronto; territorial vice-presidents—Ontario, Hon. Mr. Hearst; Quebec, Hon. Jules Allard; New Brunswick, Hon. J. K. Fleming; Nova Scotia, Hon. George H. Murray; Prince Edward Island, Hon. J. A. Mathieson; Manitoba, Hon. R. P. Roblin; Saskatchewan, Hon. A. E. Brown; British Columbia, Hon. W. R. Ross; Yukon, Commissioner Black, McKenzie, F. D. Wilson; Keewatin, Lieutenant-Governor D. C. Cameron; Ungava, the Archbishop of Montreal.

Board of Directors—William Little, Hiram Robinson, Aubrey White, E. Stewart, H. M. Price, W. B. Snowball, Thomas Southworth, Hon. W. C. Edwards, Hon. Sydney Fisher, R. H. Campbell, J. B. Miller, G. C. Edwards, Dr. B. E. Fernow, Ellwood Wilson, F. C. Whitman, G. C. Piche, Aleck MacLaurin, Carl Riordon, Mgr. Matthieu, Bishop of Regina; A. P. Stevenson, William Pearce, William Power, C. E. E. Usher, Denis Murphy, C. Jackson Booth, William Price, M.P., J. W. Harkom, A. S. Goodeve, M.P., Senator Bostock, W. C. T. Hall, J. S. Dennis. Secretary, James Lawler.

Treasurer, Miss M. Robinson.

Assistant secretary, Mr. F. W. H. Jacombe.



### THE ADVERTISERS' A B C.

We have received a copy of the "Advertisers' A B C," the standard advertisement directory for 1912, this being the twenty-sixth annual issue. This is what may be called a unique compendium, containing no fewer than 1,000 pages between strong cloth covers, of different forms of advertising. There are specimen and pictorial advertisements and articles besides long lists, classified according to different methods, of newspapers and journals in Great Britain, as well as in the United States, and the overseas parts of the Empire. Incidentally, there is a quantity of miscellaneous information on trade marks

and their use, bill-posting, also the resources and striking features of the colonies, with special reference to their possibilities of trade with the United Kingdom. The book is compiled and published by T. B. Browne, Limited, 163 Queen Victoria Street, London, E.C.



### PULP MILLS IN NEWFOUNDLAND AND LABRADOR.

Possibilities of future development are always keenly interesting, and this applies particularly to a comparison of different countries such as given as follows by the London Financial Times:—

We understand that there are at present a number of schemes being considered for the erection of wood pulp mills in Newfoundland and Labrador, and it is, therefore, of importance for the investing public to obtain some data from countries in Europe where the climate and other conditions are similar to those on the other side of the Atlantic. It is pointed out that the middle and north parts of Sweden are remarkably like North America, and we have obtained the following information about Swedish mills from the well-known specialists, Jens Orten-Boving and Co., of Union Court, E.C., who have been connected with the building of most of the pulp mills in Sweden.

There are at present 126 pulp mills working in that country, and the proportion of mechanical and chemical pulp manufactured is about even. The total output of these mills is estimated at 600,000 tons per annum, and of this about 225,000 tons are exported to England as pulp, and a further 95,000 tons as finished paper. Taking an average selling price for all classes of pulp and paper of £8 per ton, this represents a turnover of £4,800,000 per annum, and it will thus easily be understood that this industry is of considerable importance to a country like Sweden.

It is somewhat difficult to give any figures for the amount of capital invested



in these mills as most of them have grown up from very small beginnings and are old concerns, but an approximate figure for this investment of £35,000,000 would not be too high.

It is stated that, as a rule, this industry is very remunerative, even though the prices for the wood have advanced considerably during the last fifteen years. Comparing the conditions today in Sweden and Newfoundland, the cost of wood in the former country is stated to be more than twice that in the latter, and in this fact lies the chief attraction of the properties in Newfoundland. Roughly, the cost of wood for one ton of pulp produced is put at 22s. in Sweden and 10s. in Newfoundland, and as the selling price of one ton of mechanical pulp during the last three months has been about 80s. it is thought that the Swedish mills might be affected if the manufacture of pulp were started on a large scale in Newfoundland and Labrador for export to England, were it not for the fact that the world's consumption of pulp is rapidly increasing, and, at the same time the present supply of suitable wood is getting very difficult to maintain in several parts of the world. It is, therefore, quite safe to predict that even if mills aggregating a capacity of several hundred thousand tons should be constructed in the near future the pulp would eagerly be received by a waiting market.

The industry is, however, new to British investors, who, consequently, may be shy to enter upon an unknown undertaking, but if proper care be taken to investigate properties through reliable experts and to carry out the building of the mills and power developments by experienced people, such investments ought to prove profitable and sound.



#### WORKING UP PAPER WASTE.

As long as paper has been made it has been customary to work in a certain quantity of old paper, or at least to work the waste up over again, not only for the

purpose of making use of the waste, but for other reasons. Wastes can be used for all papers; the advantages, however, vary widely, and may in some instances develop into a positive detriment. In the manufacture of fine papers the paper wastes are regarded less as raw material than as filling. They may serve as both when their utilization is skilfully effected. Medium quality paper varieties can stand the admixture of a larger proportion of old paper than the better and finer sorts. As soon as a certain quantity is exceeded the translucency of fine paper becomes more clouded. The production of thin paper calls, according to experience, for the addition of a certain percentage of waste, because, as has been stated, it is an excellent filling and closes the pores, so that a close transparency is imparted to the sheet of paper and the loss of non-fibrous filling material is smaller.

If we endeavor to use as much waste as possible in thin paper, in quite thick paper we shall possibly fall below the desired quantity, says a writer in Paper, for the reason that "much waste" is liable to result in "much waste." The writer has frequently made the attempt in card free from wood to slightly increase the percentage of old paper, but my experience has invariably been unfavorable, for what has been saved in raw material has been probably lost, five times over, in waste. If, for example, the reliable limit of waste addition is exceeded, which in heavy card is low, the paper sheet will be too dense and the removal of water proceeds too slowly, so that the suction boxes and presses soon prove insufficient and the paper sheet collapses. If, however, the limit ascertained to be satisfactory is carefully observed, advantages are to be gained, in every instance, from the working up of paper waste, not only for the papermaker, but also for the consumer; for some papers, particularly those for color and variegated printing, coated paper, etc., on which a large surface is

to be printed in many colors, must have an absolutely non-porous surface. If we are not able to use this suitable paper waste filling stuff, we shall at once note that the paper lacks the close surface. In such case, the filling substance must be artificially prepared at the cost of the power plant, by grinding the fibres very short. What, however, becomes of the profit?

That in the working up of purchased wastes there are some disadvantages to be overcome, every paper maker knows. That the working up of paper wastes is in some instances indispensable, cannot be denied.

"While penning these lines," says the writer of this, whose communication was printed on an unidentified German exchange, "there occurs to me an unfortunate experience that happened in a paper factory that operated almost entirely without waste. It was the custom there that on or immediately before the completion of every lot the sample sent in by the customer was placed under the microscope. In making up the stuff, the specimen was followed as closely as possible. The sample of a printing paper, price 36 pfennigs per kilogramme, contained 60 per cent. cellulose, 30 per cent. cotton rags and 20 per cent. linen. Now, it originated in a factory known to us, that worked up no rag-stuff, could not produce it themselves, and, according to our knowledge, did not obtain it. As the selling price should not be brought into harmony with the result of the investigation and the customer would not hear of a higher price, we made the paper from Ritter-Kellner cellulose and some paper waste that originated with us and that contained no rags. The customer objected to the paper because, according to his test, it contained only about 10 per cent. of rag stock. Finally it came out that the paper factory in question bought up the waste from our customers, because they knew that we sold them only rag paper. The paper in question—that of which we had a

sample, was made with a large quantity of old paper, from which it derived the high percentage of rag-stuff."



#### CHEMICAL PROCESSES IN MANUFACTURE OF SULPHATE PULP.

Professors P. Klason and B. Segerfelt, writing in *Papier Fabrikant*, state that the sulphate process possesses the advantage over the sulphite process in that the organic matters removed from the wood can be utilized for the regeneration of the chemicals employed, without any additional fuel; there are no liquid waste products to be disposed of. An analysis of regenerated soda-ash showed: sodium carbonate, 61.73; sulphide, 21.5; sulphite and thiosulphate, 7.33; hydroxide, 3.50; silicate, 1.22; sulphate, 2.78; ferric oxide, 0.04; insoluble and loss, 1.90. The composition of the lye charged into the vertical rotary boilers so far as active alkali is concerned, is about 90-100 grms. of hydroxide, 25-30 grms. of sulphide, and 10 grms. of carbonate per litre; such a lye has a density of 16°-20° Bé. The proportion of alkali used, calculated as hydroxide, is about 20 per cent. of the dry weight of the wood. The temperature of digestion ranges from 150° to 170° C. and the time from 3 to 6 hours.

The yield of cellulose ranges from 44 to 50 per cent., according to the variety of wood, and is at least 10 per cent. higher than the yield obtained with caustic soda alone. The most serious obstacle to the general development of the sulphate process is the production of malodorous methyl mercaptan and methyl disulphide. Of these the mercaptan is by far the worse; the proportion of mercaptan varies according to the conditions of boiling; a high proportion of alkali reduces the quantity of mercaptan, tending to convert it into disulphide; thus in the manufacture of high-boiled "easy bleaching" pulp, about 100 grms. of mercaptan are obtained per ton

of dry wood; but in making a low-boiled "strong" pulp with a reduced proportion of alkali, the quantity may be ten times as great. Under equal conditions, pine wood yields about twice as much mercaptan as spruce wood. The authors have made a detailed investigation of the organic matters contained in the black lye from the digesters. The concentrated lye was saturated with carbon dioxide and heated at 110°-120° C.; the precipitated alkali-lignin was thus coagulated. A further quantity of free lignin was obtained on acidifying the filtrate; this fraction contained the fatty acids and resins, which were extracted by chloroform. Formic and acetic acids were obtained from the filtrate by distillation. The residue was treated for the separation of lactones and lactonic (saccharinic) acids. Calculated on 1,000 grms. of organic substances, the results are summarized as follow: lignin, 542.9 grms.; fatty and resin acids, 24.7 grms.; formic acid, 36.9 grms.; acetic acid, 51.6 grms.; lactonic acids, 303.4 grms. Of the sulphur originally present as alkali sulphide, 51.8 per cent. was combined with lignin, 15 per cent. expelled as volatile organic compounds, 16.8 per cent. remained after digestion as alkali sulphide, but rapidly changed on storage whilst 16.4 per cent. was unaccounted for, probably oxidized. In the digestion of wood by the sulphate process, the gummy carbohydrates are converted into saccharinic acids; the gums also probably account for the formic and acetic acids, the latter possibly being derived from the pentosans. The lignin molecule is split up into similar derivatives of lower molecular weight, two free hydroxyls being opened out per molecule of lignin ( $C_{30}H_{40}O_{12}$ ), in virtue of which the products become soluble in the alkali. At the same time the lignin combines with sulphur and it loses about one-fifth of its methoxyl, this group being hydrolyzed with formation of methyl alcohol and its sulphur derivatives. Meta- and parasaccharinic acids

have been characterized as well as a new form of isosaccharinic (sapin-) acid which constitutes the main component of this fraction. The combination of about one-half of the sulphur with the lignin and the reaction between the methyl alcohol and the alkali sulphide suggests that this portion of the lye only gradually becomes caustic as the digestion proceeds; hence the cellulose fibre is protected from the too drastic action of a strong caustic lye. Nevertheless, it is desirable to employ more than 25 per cent. of the total alkali in the form of sulphide, since the production of mercaptan would tend thereby to be increased.



#### PAPER STRETCHING.

Probably nothing gives so much trouble and anxiety to the color printer as register. Any information bearing upon this matter will probably assist him in his efforts to overcome this difficulty. There is little doubt a variable climate has more to do with the creation of register trouble than any other cause. Could we ensure a uniform degree of humidity in the atmosphere, the "stretch of paper" would be little heard of. It is not so much a question of temperature; it is the amount of moisture which affects paper, so far as stretch is concerned.

The letterpress printer is not troubled about register anything like so much as the lithographic printer.

In the first case it is often possible to shift the plates on a board, or shift the type in a forme, into register to suit a run of paper, but it is not possible to shift the work on a stone or metal plate once it has been made up; and to make up stones or plates to suit the variations often found in the run of color work is impracticable. Hence all the printer can hope for is a fit to suit the majority of the sheets. But this is a very unsatisfactory state of affairs.

The printer is often blamed for bad printing through causes beyond his control, when the fault lies at times with the paper-maker. Possibly the paper-maker may be ignorant of the trouble he is giving the printer. Let us hope so.

With the object of showing how much paper stretches when damp, and how much more it stretches across the web than along the web, I have made the following experiments.

It is not possible to choose samples which can be classed as "standard papers," but Messrs. Spalding and Hodge have kindly supplied the fourteen different classes of paper experimented with, and these can be taken as excellent samples of their class. A sufficient number of sheets in each class were tested to ensure a reliable average, and where possible a fairly accurate description of the composition of the paper is indicated.

Each sheet of paper was cut to a size exactly twelve inches square. They were then placed between saturated sheets of blotting-paper and stacked for twenty-four hours under light pressure. Each sheet was then measured across and along its surface, when the results as shown in the table were obtained. The sheets were then dried by placing each one upon dry blotting-paper in racks and allowed to remain for some days; they were again measured and the dimensions tabulated. It is possible the significance of the stretch will be more readily appreciated in the alternate columns giving the amount of stretch as a decimal of 1-32nd of an inch, and it must be borne in mind this variation takes place in a small sheet of 12-in. square and would increase in proportion.

From figures resulting from experiments made in England, it will be seen how all classes of paper stretch with moisture more across the web than along it; that is to say, the fibre opens out and stretches more than it lengthens. And what has taken place with an excess of moisture takes place in proportion with a lesser amount.

When paper is being printed, the squeezer, to a large extent, lies in the direction round the cylinder, and not across. That being the case, it is most important that the web of the paper shall be in the direction of "round the cylinder," because we have found by the experiments that less stretch takes place in the direction of the web than across it. If the web of the paper is in the direction across the cylinder the squeeze in printing will further aggravate the trouble.

This is the fact I wish to bring home to the paper-maker. It is courting trouble to supply paper cut the wrong way. In all cases, the direction of the web should be along the narrowest way of the sheet, because it is the narrowest way which goes round the cylinder. In 20 by 30 paper, for instance, the direction of the web should be along the 20-in. way; in 30 by 40 it should be along the 30-in. way, and so on. Paper-makers must understand that while a sheet, say, of double royal, being made correctly, gives every satisfaction, it will not produce two sheets of royal which are satisfactory in the same sense. The direction of greater stretching quality is now the direction round the cylinder and just where the paper is weakest, its weakness is now aggravated by pressure.

This is bad enough; but what excuse can be made for the paper-maker who mixes paper so that the direction in the working of one job is both ways? I am afraid this is a somewhat common practice, but it is one which should be absolutely condemned. For instance, a 70-in. reel should not be cut in part 30 by 40 and part 40 by 30.

The paper-maker does this to prevent waste, but 30 by 40 should be cut from an 80-in. or 120-in. reel, not a 70-in. or 90-in. In the latter case, the direction of the web will be wrong. In the former, mixed direction will take place. To test this, if you have a suspicion the paper is mixed, take sheets of the paper, and off corresponding edges of each sheet cut a strip about 6 inches by  $\frac{1}{2}$ -inch.



Hold the ends between your finger and thumb, and allow the strips to bend over; if the paper is not mixed each piece will bend pretty well alike, but if mixed some will stand out stiff and others droop, showing that the stiffer strips have been cut off in the direction of the web and others across the web.

The same test, to show which is the direction of the web, can be made by first marking with a pencil a line along one edge of the sheet of paper, then cut two strips 6 by  $\frac{1}{2}$  inch off the pencil edge and its right angle edge. Place one strip on top of the other and hold the ends between the finger and thumb; the strip which stands out stiffer than the other is the one cut the way of the web, whilst the other strip is across the web. Noting which strip has the pencil mark will easily tell you the web direction of the paper.

Although paper is not generally used in a damp state, it is often so used for colotype, intaglio printing, and embossed work. And if for register work, woe betide the printer who cuts his paper out of a sheet various ways, or who receives paper from the mill cut off the reel both ways. He will never register the sheets when they are dry. Perhaps some bitter experience with this trouble in emboss work and in Baxter color printing has suggested my writing this article and pointing out the difficulties likely to arise.

The result of the experiments shown in the table will provide thought for other questions besides the particular one I have dealt with, but it is not my intention to deal with any other phase in this article. Such questions as the weight of paper, the composition of paper, the addition of loading, etc., as bearing upon the amount of stretch, readily occur to mind, but they do not affect the general question of proportion of stretch the two ways of the sheet.

It is interesting to notice the figures showing the amount of shrinkage when the paper becomes dry. It is difficult

to guarantee that the measurements were taken when the paper contained exactly the same amount of moisture as in the period before they were damped. For this reason it is possible some slight modification of the figures tabulated should be made, although every care was taken to ensure careful analysis. All the samples, except two, dried to less than original size. Probably the paper now bulks a trifle more.



## PULP AND PAPER MARKETS.

Toronto, Feb. 10th, 1912.

The demand for newsprint fell off slightly towards the end of last month, both for domestic and export requirements. In view of the very unusual rush of orders previous to that time, it is scarcely fair to complain of a return to more normal conditions. In January there is quite frequently a lull in business in most branches of the paper trade, stock-taking and annual report preparing, perhaps, being the main features, and this year practically all branches of trade and industry in Canada show healthy conditions. Prices for newspaper continue steady.

Book and writing papers are rather dull, but prices keep about as before. Some cutting is heard of among some of the coated paper mills. Manilas and wrappings are in better demand, and there is a disposition with some mills to raise prices, an action which should have been taken earnestly months ago in view of the status of this branch of the industry. Kraft is still easy, with prices being cut to an absurd degree.

In the pulp market a waiting attitude is being adopted. Operations at the mills have been hampered by cold weather, both in Canada and the northern States, and, as stocks are quite low, there should be a good demand at high prices. But apparently buyers do not like these prices, and, as holders refuse to sell for less and discourage quotations ahead, the actual business



transacted has been below the mark. It is believed, however, that this state of things cannot last long, and that buyers will enter the market more vigorously, with the result that prices may go up still further. Sulphite is still in brisk demand at the high prices prevailing.

We quote:—

News print, rolled .....	\$1.90 to \$2.00
News print, sheets .....	2.15 to 2.25
Book papers—Carload lots	
No. 3 .....	4 to 4½c.
Book papers—Broken lots	
No. 3 .....	4½ to 4¾c.
Carload lots No. 2 .....	4¾c.
Broken lots No. 2 .....	5½ to 5¾c.
Carload lots No. 1 .....	5½ to 6¼c.
Broken lots No. 1 .....	6 to 6¾c.

#### Wrappings—

Manila B. ....	2½ to 3¼c.
Fibre .....	3½ to 4 c.
No. 2 Manila .....	3¼ to 3¾c.
No. 1 Manila .....	3½ to 4 c.
Kraft .....	4¼ to 4¾c.

#### Pulp—

Ground wood (at mill) ...	\$16 to \$18
Sulphite (bleached) .....	\$53 to \$55
“ (unbleached) .....	\$42 to \$44

#### Waste Papers—

Per 100 lb.  
F.o.b. Toronto.

No. 1 Hard White	
Shavings .....	\$1.65 to \$1.75
No. 2 Hard White	
Shavings .....	.....
White Envelope Cut-	
tings .....	\$1.65 to \$1.75
No. 1 Soft White	
Shavings .....	\$1.45 to \$1.50
No. 2 Soft White	
Shavings .....	\$1.25
No. 3 Soft White	
Shavings .....	\$1.10
White Blanks .....	\$1.10
Mixed Shavings .....	35 to 37½c.
Heavy Ledger .....	\$1.27½ to \$1.40
Ordinary Ledger .....	\$1.00 to \$1.10
No. 1 Flat Books .....	80 to 90c.

No. 1 Book Stock .....	75 to 80c.
No. 2 Book Stock .....	39½ to 40c.
No. 1 Manila Envelope Cuttings...	\$1.20
No. 1 Print Manilas .....	65c.
Railway Manilas .....	55c.
Folded News Overissues .....	45c.
Folded News .....	45c.
Crushed News .....	.....
No. 1 Mixed Papers .....	25 to 30c.

#### Rags (New and Old)—

Per 100 lb.

1st Old White Cottons .....	\$2.00
2nd Old White Cottons .....	.....
Thirds and Blues .....	\$1.25 to \$1.45

#### Roofing Stock—

Flock Satinets .....	75 to 80c.
Ordinary .....	55 to 60c.
Tailor Sweepings .....	55 to 57½c.
No. 1 White Shirt Cuttings	\$4.75 to \$5.00
No. 2 White Sheet Cuttings	.....
Fancy Sheet Cuttings .....	\$3.65 to \$3.75
New Blue Prints .....	.....
New Blue Overalls .....	\$3.42½ to \$3.65
New Black Overalls .....	\$1.60 to \$1.70
New Black Linings .....	\$1.60 to \$1.75
New Unbleached Cottons .....	.....
Bleached and Unbleached Shoe Clips...	.....
New Light Flannelettes ..	\$3.75 to \$4.40
New Light Shirt Cuttings	\$3.90 to \$4.35
Light and Dark Cords .....	.....



With reference to the affairs of the Sturgeon Falls mills, a correspondent enquires as to where the creditors of the old company now stand since the acquisition of these properties by the Spanish River mills. We understand that the Ontario Government imposed the condition that \$25,000 should be set aside for such of the Canadian creditors as were unsecured. This does not apply to foreign creditors. The Government will see to it that this money is appropriated to these unsecured creditors before the transfer is validated.

---

**EMERSON MANUFACTURING CO.**  
**LAWRENCE, MASS.**

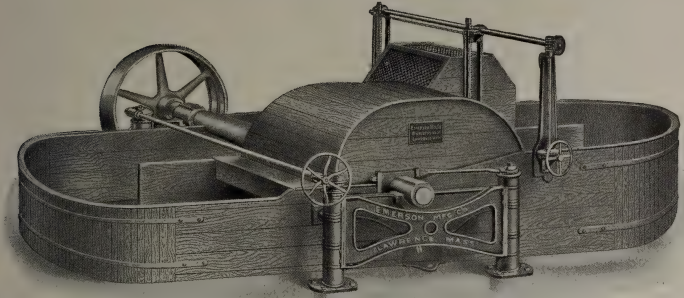

Beating and Washing Engines  
Paper Mill Machinery

---

**THE UNITED WIRE WORKS LTD.**

Edinburgh, Glasgow & Newcastle on Tyne.

**FOURDRINIER WIRES**  
**CYLINDER WIRES**

Wire Cloth all meshes, in Brass, Copper Bronze & Steel.

SOLE AGENTS FOR CANADA

**ARTHUR P. TIPPET & CO., 8 Place Royale, MONTREAL.**

Wires held in stock at Montreal for prompt delivery.

If you have not ordered a copy of the new "Canadian Pulp and Paper Directory," do it now. Your promptness will save you \$1. The price to non-subscribers, after publication, will be \$3. To subscribers before publication \$2. See advt. on page 39.

Address:

**BIGGAR-WILSON, LIMITED**  
 CONFEDERATION LIFE BLDG,  
 TORONTO

## WANTED

by a British Mill, making high class S/C. and M/F. Printings, Cream Laid, Bond Papers, Bank, Drawing Cartridges, Duplex and Triplex Boards, Manillas, etc., a thoroughly capable man as sole Representative for Canada. Applications in confidence stating full particulars to Box, 48, "Pulp & Paper Magazine," Toronto.

Edward A. Jones, President and Treasurer.

Wallace E. Bardwell, Secretary.

**F. D. JONES & SONS CO., Pittsfield, Mass.**

Manufacturers of

**PAPER MAKING MACHINERY  
 AND MECHANICAL ENGINEERS**

Beating Engines. Washing Engines. Mixing Engines. Bleaching Engines.  
 Cooking Engines. Vertical and Horizontal Stuff Chests.

Jordan Engines of three sizes, either belt or direct-connected motor-driven;  
 fillings of Wagg Steel or stone type, three-part or plain.  
 Dusting Machinery of all kinds.

# CLASSIFIED ADVERTISERS' INDEX.

If you fail to find what you want in these columns, write us and the desired information will be gladly supplied.

## Architects and Engineers

Ambursen Hydraulic Con. Co.  
 Fred C. Anderson  
 Clark & Lyford  
 F. W. Dean  
 J. A. DeCew  
 Eaton & Brownell  
 Fibre Development Co.  
 G. o. F. Hardy  
 Herbert S. Kimball  
 International Process Co.  
 Arthur D. Little, Inc.  
 R. S. Lea & H. S. Ferguson  
 Lyford, Clark & Lyford  
 H. B. Prather  
 T. Pringle & Son  
 Stebbins Eng. & Mfg. Co.  
 R. O. Swezey  
 Jos. H. Wallace & Co.

## Barkers.

Green Bay Barker Co.  
 Jenckes Mach. Co.  
 Waterous Engine Works.

## Barker and Chipper Knives.

Crookes, Roberts & Co.  
 Peter Hay Knife Co.  
 A. P. Tippet & Co.

## Beaters.

Dayton Globe Iron Works  
 Emerson Mfg. Co.  
 Holyoke Mach. Co.  
 E. D. Jones & Sons Co.  
 Valley Iron Works  
 Waterous Engine Works

## Beater Rolls.

J. A. DeCew  
 J. Marx & Co.

## Belting.

Dom. Belting Co.  
 General Supply Co.  
 F. Reddaway & Co.  
 Sadler & Haworth

## Bleaching Powders.

Hooker Electro-Chemical Co.  
 Winn & Holland

## Bond Papers.

Northern Mills Co.

## Book Papers.

Canada Paper Co.  
 Northern Mills Co.

## Brass Wire Cloth, Fourdrinier Wires.

Geo. Christie, Ltd.  
 J. M. Douglas & Co.  
 Herman Finckh  
 C. H. Johnson & Sons, Ltd.  
 A. P. Tippet & Co.  
 United Wire Works.  
 P. P. Westbye

## Calendar Rolls.

Farrel Foundry & Mach. Co.

## Chemicals, Colors, etc.

Brunner, Mond & Co.  
 Gewerkschaft Sachtleben  
 A. Klipstein & Co.  
 Paper Makers' Chemical Co.  
 United Alkali Co.  
 Wilson-Paterson Co.

## China Clay.

China Clay Co.  
 A. Klipstein & Co.  
 C. A. Meincke & Co.  
 Paper Makers' Chem. Co.  
 Wilson-Paterson Co.

## Chippers

Carthage Machine Co.

## Coated Paper.

Canada Coating Mills  
 Canada Paper Co.

## Conveying Machinery.

Jeffrey Mfg. Co.

## Digester Lining.

Panzl Digester Lining Co.  
 Preston's Digester Lining Co.  
 Stebbins Eng. & Mfg. Co.

## Drainer Bottoms.

Samuel Snell Co.

## Evaporators

Ernest Scott & Co.  
 Swenson Evaporator Co.  
 Zarembo Company

## Felts.

F. Bredt & Co.  
 Dallyn, Jardine & Co.  
 Hamelin & Ayres Co.  
 C. H. Johnson & Sons, Ltd.  
 Penman's Ltd.  
 Joseph Porritt & Sons.  
 J. H. Spencer & Sons  
 A. P. Tippet & Co.

## Grinders.

Dayton Globe Iron Works  
 Glens Falls Mach. Co.  
 Holyoke Machine Co.  
 Jenckes Machine Co.  
 Waterous Engine Works.

## Kraft Paper.

N. B. Pulp & Paper Co.

## News-Paper, Wrappings, etc.

New Brunswick P. & P. Co.  
 Riordon Paper Co.

## Paper and Pulp Dealers

Atterbury Bros.  
 Castle, Gottheil & Overton.  
 Parsons Trading Co.  
 Pulp and Paper Trading Co.  
 A. Wertheim & Co.  
 Riordon Paper Co.

## Paper Stock, Rags, etc.

Atterbury Bros., Inc.  
 J. Christie Co  
 R. Hough  
 The Howell Co.  
 E. Pullan  
 J. R. Walker & Co.

## Paper and Pulp Mill Machinery.

Appleton Machine Co.  
 W. G. Ashdown  
 Baker & Shevlin Co.  
 Beloit Iron Works  
 Bentley & Jackson  
 James Bertram & Son, Ltd.  
 Bertram's, Limited  
 The Black-Clawson Co.  
 Canadian Boving Co.  
 Carthage Machine Co.  
 Dayton Globe Iron Works Co.  
 Dillon Machine Co.  
 Emerson Mfg. Co.  
 Farrel Foundry & Machinery Co.  
 M. Garland Co.  
 Glens Falls Machine Works.  
 Green Bay Barker Co.  
 Harmon Machine Co.  
 Holyoke Machine Co.  
 Jenckes Machine Co.  
 E. D. Jones & Sons Co.

## C. H. Johnson & Sons, Ltd.

Jas. Milne & Sons.  
 Moore & White Co.  
 B. F. Perkins & Son.  
 Rice, Barton & Fales  
 Ryther & Pringle.  
 Sandy Hill Iron & Brass Works.  
 Ernest Scott & Co.  
 Sherbrooke Machinery Co., Ltd.  
 S. Morgan Smith.  
 Stebbins Engineering & Mfg. Co.  
 Swenson Evaporator Co.  
 Ticonderoga Machine Works.  
 Valley Iron Works.  
 J. M. Voith.  
 Charles Walmsley & Co.  
 Chr. Wandel.  
 Wandel Screen Mfg. Co.  
 Waterous Engine Works Co. Ltd.  
 P. P. Westbye.  
 Zarembo Co.

## Paper Testers.

Dobler & Mudge.

## Pipes (Wooden)

Eastern Pipe & Construction Co.

## Pumps.

Lawrence Pump & Engine Co.  
 John McDougall Caledonian Iron Works.  
 Smart-Turner Mach. Co.

## Rosin Size.

Paper Makers Chemical Co.  
 Vera Chemical Co.  
 United Alkali Co.  
 Wilson-Paterson Co.

## Screen Plates.

Union Screen Plate Co. of Can.

## Screens.

W. G. Ashdown  
 Harmon Machine Co.  
 Sherbrooke Machinery Co.  
 J. M. Voith.  
 Chr. Wandel.  
 Wandel Screen Mfg. Co.  
 Waterous Engine Works.  
 P. P. Westbye.

## Sulphur.

Union Sulphur Co.

## Tanks.

G. Woolford Wood Tank Mfg. Co.

## Transmission Machinery.

Dodge Manufacturing Co.

## Travelling Cranes.

Advance Mach. Co.  
 Hugh R. Blethen  
 Northern Eng. Co.  
 Smart-Turner Mach. Co.

## Turbines.

Dayton Globe Iron Works.  
 S. Morgan Smith Co.

## Water Wheels.

Dayton Globe Iron Works.  
 Holyoke Machine Co.

## Wood Pulp Agents.

Castle, Gottheil & Overton.  
 Parsons Trading Co.  
 Scandinavian Amer. Trading Co.  
 A. Wertheim & Co.

## NEW AMERICAN TURBINES

Represent the development of over fifty years experience in the designing, construction and operation of Water Power Machinery. We build all of the machinery equipment required in any water power development from dam to generator coupling.

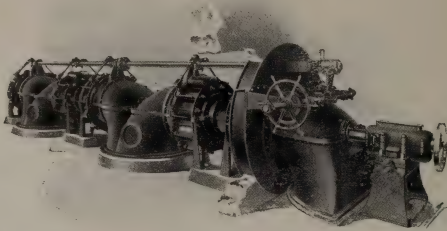

The above illustration shows one of twelve 1,000 H.P., 210 R.P.M. units being installed for the Lake Superior Paper Co., Ltd., Sault Ste. Marie, Ontario.

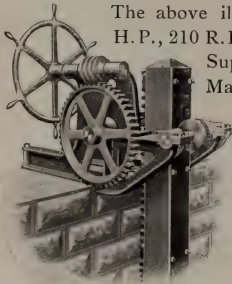

The cut to the left shows our No. 5 Head Gate Hoist, of which we have a complete line of patterns.

The illustration below shows one of eight Cooking Engines furnished Michigan Paper Co., Plainwell, Mich.

*Catalogue No. 27 will tell you more about our products.*

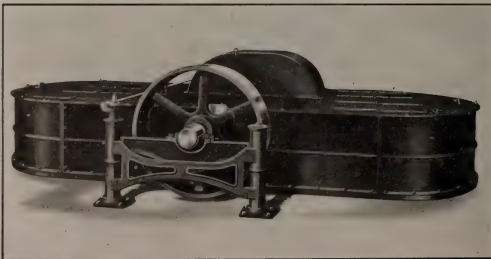

**THE DAYTON GLOBE IRON WORKS COMPANY**  
DAYTON, OHIO, U.S.A.



SPECIFY

“**AMPHIBIA**”

(WATERPROOF)



**LEATHER  
BELTING**

**For All Drives in  
Wet Places**

*It's the Best for this service, and  
is specially made for it.*

Write to

*Sadler & Haworth*

**TORONTO**

511 William St.

**MONTREAL**

27 Melinda St.

**ST. JOHN, N.B.**

89 Prince William St.

**WINNIPEG**

244 Princess St.

**VANCOUVER**

217 Columbia Ave.

For over thirty five years  
the makers of the best  
leather belts.

## TESTING AND IMPROVING ROSIN SIZE.

In papermaking the finished product and its desirable constant uniformity depend on several chemical and mechanical processes observed in the process of manufacture. The manufacturing processes must be controlled exactly. To know the quality of the fibre, of the wood pulp, of other plants or rags, their uniform treatment in the beaters and finally the run over the paper machine, are the most important desiderata of mechanical work.

Boiling and bleaching, especially bleaching with a uniform quantity of chloride of lime, washing and coloring, the uniform sizing of the paper, are all processes of a chemical nature. To have the raw materials always in such shape that the acting chemicals are analytically known to the superintendent of the manufacturing process, he must know the tools and measures of his work, the fineness of the rosin emulsion used, and the quantity of free rosin contained in it. The alkali strength is of prime importance in the use of rosin emulsion sizing paper.

If the size emulsion, especially that used on writing paper, is not in the finest state of subdivision, two or three times the amount of rosin must often be used, without even then obtaining the effect desired.

The determination of the insoluble residue and mineral impurities in rosin is conducted as follows: About one-half ounce of rosin is weighed out and dissolved in a small quantity of alcohol, the quantity of residue that remains undissolved being noted. If the amount is appreciable, the alcoholic liquid is filtered off and the residue transferred to filter paper, washed with a little more alcohol until free from rosin and then dried and weighed in a stoppered weighing bottle. The filter paper has been, of course, previously dried and weighed in the bottle and its weight deducted

from that of the paper with the residue, the difference giving the total insoluble residue. The filter paper and residue are now ignited in a platinum crucible and the ash weighed. This will give the weight of the mineral impurities. The quantity found should not exceed 1 to 2 per cent.

Rosin belongs to a class of chemical substances known as organic acids, and, like all such, reacts with alkalis to form salts. When heated with sodium hydroxide or sodium carbonate it forms a sodium salt.

Rosin frequently contains substances which are not capable of forming salts or soaps. These substances are classed together as unsaponifiable matter. The quantity found in American rosins does not usually exceed 10 per cent.

The determination of unsaponifiable matter depends upon the fact that while most of the unsaponifiable substance is soluble in ether, rosin soap is insoluble. Ten grammes of the rosin are placed in a flask with a solution prepared by dissolving 5 grammes of sodium hydroxide in a small quantity of water and adding 50 c.c. of alcohol. The flask is connected with an inverted condenser and heated for an hour or so on a water bath, so that it just boils. The alcohol is now distilled and the residue of soap dissolved in 50 c.c. of hot water and transferred to a separating funnel. The flask is rinsed out with a few c.c. of water and the combined alkaline liquids extracted with 50 c.c. of ether. The ethereal and aqueous liquids are thoroughly mixed and set aside for the ether to separate out. This may take some little time and it is well to leave it over night. In the morning the lower aqueous layer is run off as completely as possible and the ether left in the separating funnel washed by adding 10 or 20 c.c. of water, shaking up and allowing the water to settle. The water is drawn off and the ether transferred to a weighed flask and distilled.

(Continued in next issue.)

# PAPER AND CLOTH SPECIALTIES

For Rent and Club Cards, Pattern Cards, Map Printing,  
Label Printing, Envelopes, Etc., Etc.

*Cloth Lined Papers. Cloth Centred Papers and Boards. Cloth Lined, Chromo and Enamel. Cloth Lined Boards and Cards, (surfaced and enamelled). Cloth centred Boards, (surfaced and enamelled). Manilla Surfaced Boards and Cards.*

ALSO

*Ename led Blotting.*

*Paste Boards.*

*Art Papers.*

*Chromo and Surface Papers.*

Customers' requirements in specialities are carefully considered and experiments conducted if necessary.

**ALBERT E. MALLANDAIN,**

51, Cheapside,

- - London, England.

# HERMANN FINCKH

REUTLINGEN

*Established 1879*

GERMANY

---

# FOURDRINIER WIRES

---

**SULPHITE - MACHINE WIRES**  
**CYLINDER WIRES**

---

---

**P. P. WESTBYE, - Peterborough, Ontario**

*Sole Agent for Canada*

**PRESTON'S**

# Lining for Sulphite Digesters

TOTAL THICKNESS ONLY  $2\frac{1}{2}$  TO  $2\frac{3}{4}$  INCHES

Resists the action of the acid and ensures absolute protection to the Digester Plates.

Great durability, therefore large saving in upkeep and repairs.

Larger internal space and increased production on account of the small thickness occupied.

Extensively adopted by Scandinavian and Continental Mills.

Over 200 Digester Linings in work and on order.

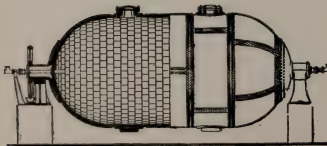
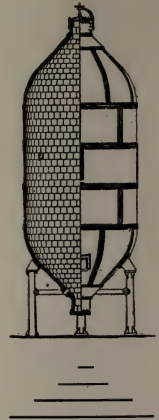

Telegraphic Address :

**"PRESTONS, RADCLIFFE."**

CODE USED, A. B. C. 4TH & 5TH EDITION.

*Full Particulars and Prices on application to SOLE MANUFACTURERS*

## PRESTON'S DIGESTER LINING CO., LIMITED

RADCLIFFE, near Manchester, Eng.

# Fans for the Paper Mill



We make a specialty of Ventilating and Exhaust Fans for all kinds of Paper Mill Work. Keep a copy of our No. 85 Catalog in your files for ready reference.

**B. F. PERKINS & SON, Inc.**  
**HOLYOKE, MASS.**

**FROZEN PULP AND DRY PULP  
IN A**

## Ryther Shredder

Is shredded at the rate of 5 tons per hour.  
17 to 25 H. P. required. The above figures are  
*dry weight* and absolutely guaranteed.

RELIEVE YOUR BEATERS and INCREASE QUALITY  
and PRODUCTION. Write for full Particulars.

---

---

**Ryther & Pringle Company**  
Carthage, N.Y.



VALLEY IRON



WORKS COMPANY

# BEATING AND WASHING ENGINES

IRON OR WOOD TUBS

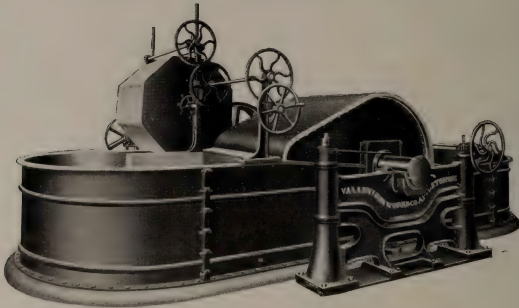

*PERFECTION IN EVERY DETAIL.*

Beating, Washing and Bleaching Engines. Barkers—Barker Attachments—Chippers—Rechippers—Chip Screens (Revolving)—Knot Screen (Revolving)—Diaphragm Screens—Felt Washers—Deckers (Single and Double)—Stuff Chests (Vertical and Horizontal)—Tanks (Blow Off, Acid and Water)—Pulpwood Saws (Friction and Steam Feed)—Pulpwood Splitters (Vertical and Horizontal)—Shredders and Special Washers for old Paper Stock—Wet Machines and Patent Roll Skinners—Bronze, Semi-Steel, Lead and Iron Castings.

Manufacturers of Paper and Pulp Making Machinery in

*All Standard Forms. — Many Special Designs*

**ENGINEERS, FOUNDERS AND MACHINISTS**

*Correspondence Invited*

**VALLEY IRON WORKS COMPANY**

APPLETON, WIS., U.S.A.

---

---

FARREL FOUNDRY AND MACHINE  
COMPANY

ANSONIA, CONN., - - - U. S. A.

Largest Manufacturers in the world of

**CHILLED ROLLS**

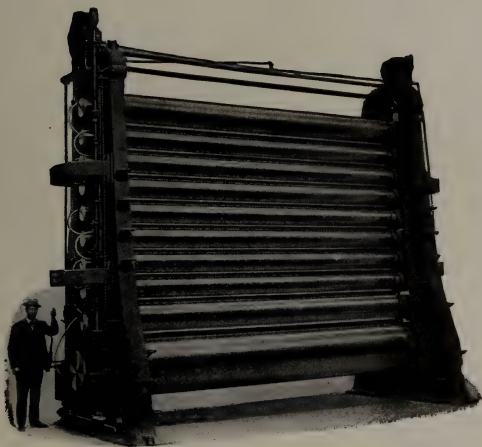

**CALENDERS**

*WITH PATENT HYDRAULIC LIFT*

**ROLL GRINDING MACHINES**

---

---

*Would YOU like to enlarge your Business and find new Customers in all parts of the world? If so, ADVERTISE in*

# “THE PAPER-MAKER AND BRITISH PAPER TRADE JOURNAL.”

THE LEADING AND MOST POPULAR TRADE ORGAN.

**THE ADVERTISER IS GOOD FOR THE READER**

We recently received the following letter:—

“We have hesitated over the matter, as we are at present so busy as to regard further advertising as almost superfluous.

“On the whole, however, we find it pays us better to have to refuse orders than to hunt after them, and will ask you therefore to insert our advertisement on same terms as last.

“We enclose herewith amended matter for advertisement, and shall be glad to have proof of same at your early convenience.”

We are constantly in the receipt of gratifying letters relative to the usefulness of our Journal, and we have pleasure in printing the following:

“Gentlemen,

We beg to advise that we have not as yet received the June number of ‘THE PAPER-MAKER AND BRITISH PAPER TRADE JOURNAL.’

We like the publication so well that we should be very sorry indeed to miss a copy of it.

Thanking you in advance for your kind attention,

We are, dear Sirs, yours very truly,  
F. R. KEYES & SON.  
20 Broad Street, New York.”

## S. C. PHILLIPS & Co.'s STANDARD PUBLICATIONS

### The Paper-Maker

AND BRITISH PAPER TRADE JOURNAL.

Published on the 1st of each month. Price 1s., by post 1s. 6d. Annual Subscription 12s. 6d. post free.

**The Stationery World,  
Printing and Allied Trades,  
AND FANCY GOODS REVIEW.**

Published on the 25th of each month. Price 6d. by post 7½d. Annual Subscription 5s. post free.

Chief Offices:

47 CANNON STREET, LONDON, E.C. (ENGLAND).

### The Paper Box and Bag Maker.

Published on the 19th of each month. Price 6d., by post 7½d. Annual Subscription 6s. 6d. post free.

**Phillips' Paper Trade Directory  
of the World.**

15s. 6d., post free to all countries.

NEW EDITION FOR 1911 NOW READY.

Specimen Copies and Advertisement Rates  
FREE OF APPLICATION.

We are now rapidly compiling the new  
edition of the

# Canadian Pulp and Paper Directory

This Directory will contain Complete Lists of Pulp and Paper Mills, giving capacity, machinery, etc.; Wholesale Paper and Stationery Dealers; Printers and Publishers; Lithographers, Bookbinders and Rulers; Manufacturers of Stationery, Paper Bags, Boxes, etc.; also Retail Stationers and Booksellers of Canada.

ADVERTISING RATES	}	1 Page, \$25	} Each advertiser receives a copy of the book.
		1/2 " 15	
		1/4 " 8	

If ordered in advance, \$2 per copy

After publication, \$3

Send in your order now.

**BIGGAR - WILSON, LIMITED**  
TORONTO, CANADA

**UNDER MANAGER.**—Young man, 14 years' practical experience in English mill making long elephants, news, all-wood printings, cream laid, etc. Experienced mill chemist—testing of papers, fibres, etc. Highest references. Address H. C., c/o Pulp and Paper Magazine.

**FOR SALE.**

A 92-inch Fourdrinier machine, complete, now running in Canadian mill, to make room for a larger machine.

For particulars, etc., address Box 25, Pulp and Paper Magazine.

**WANTED.**—Superintendent for a new 150-ton ground wood mill. One with technical education preferred. Please state education and experience in full; also give age, if married or single, and salary asked for. Address Box 27, care Pulp and Paper Magazine, Toronto.

**PAPER MILL ENGINEER.**—Technical graduate, ten years' experience, now consulting engineer for one of the largest paper mills in United States, wants change. Open for engagement in near future. Will give part or whole time. Apply Box 26, Pulp and Paper Magazine, Toronto.

As we are using all our Water Power at our Pulp Mill for electricity, we are disposing of the Pulp Mill Machinery—including Millard Patent Grinders which were in use only a few months and are absolutely as good as new, also Wet Machines, Barkers, Screens, Pumps, Piping, Shafting, Stones, etc., etc., all in good condition. Full information will be given upon application.

Apply Box "A,"

Pulp and Paper Magazine,

Toronto.

**A GENTLEMAN** from Scotland, resident in Toronto, having had practical experience in all departments of paper making, would like to hear from firms to whom his services might be of use. He has had wide and varied experience "on the road" in the printing and stationery trades, also the manufacture of paper bags. Box (S.W.) Pulp & Paper Magazine.

The Toronto Paper Manufacturing Company has ordered a Margalt suction roll to take the place of their couch press at present in use. The new roll, together with pump for the same, will be supplied by the firm of J. Marx & Co., Finsbury Pavement, London, England.

**GEWERKSCHAFT SACHTLEBEN**

Homburg-Niederrhein  
GERMANY

Largest Makers  
of all Qualities

**Blanc Fixe**

Three  
Varieties

Bright  
Matt or Dull  
Photographic



**SCOTT'S IMPROVED RECOVERY SYSTEMS**  
**FOR**  
**SODA, SULPHATE AND SULPHITE**  
**SPENT LIQUORS GIVE THE**  
**MAXIMUM ECONOMY AND EFFICIENCY**

*The* **PRINCIPLE**  
*The* **DESIGN**  
*The* **CONSTRUCTION**  
*The* **OPERATION**  
*The* **RESULT** } **IS RIGHT**

Complete Installations made by "THE FIRM WITH THE EXPERIENCE"

**ERNEST SCOTT & CO. MANUFACTURING ENGINEERS**  
**FALL RIVER, MASS. and MONTREAL, P.Q.**

**SODA OR SULPHATE**

**RECOVERY SYSTEM**  
**MAXIMUM EFFICIENCY      MINIMUM LOSSES**



**WELDED DIGESTERS      MULTIPLE EFFECT EVAPORATORS**  
**AND OTHER PULP MILL EQUIPMENT**

**SWENSON EVAPORATOR CO.**

945 Monadnock Bldg. . . . . CHICAGO

Established  
1869**CHR. WANDEL,**Established  
1869

REUTLINGEN . . . GERMANY

Paper Machine Wire and Engineering Works

SOLE MANUFACTURER OF

The Original "WANDEL" Rotary Screen

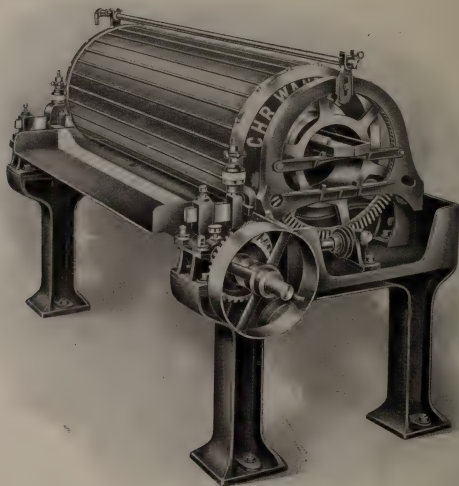
Over  
3,000  
Apparatus  
SoldNo authorized  
builder in  
Canada  
or the States**ADVANTAGES:**

Regular output of Pulp

Large working ability

Less Power . . . Great Strength and Durability

Suitable for all classes of Paper

Automatic removal of Knots

Avoidance of Stoppage

Agent for Canada

**W. G. Ashdown, 1649 Mance St., Montreal**

HIGH GRADE  
**“VICTORIA” TURBO PUMPS**

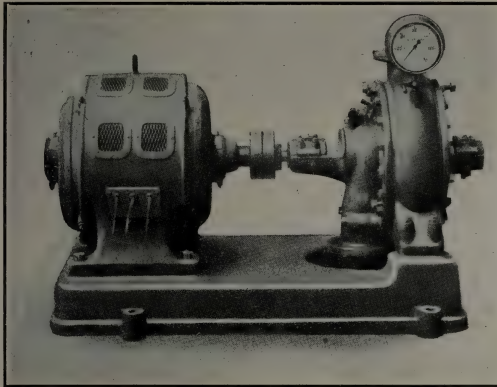

---

---

Suitable for all conditions. Water, pulp, caustic or acid. Highest efficiency. Flat characteristic curve. Unrivalled workmanship.

---

---

**THE CANADIAN BOVING COMPANY, LTD.**  
164 BAY STREET : : : : TORONTO

# A GOOD JORDAN ENGINE

BUILT IN 3 SIZES

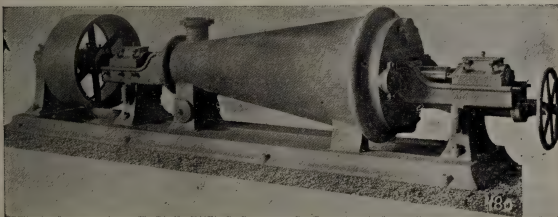

**THE BLACK-CLAWSON CO.**  
HAMILTON, OHIO, U.S.A.

Builders of **PAPER MAKING MACHINES** and machinery for Paper and Pulp Mills. Our machines are completely erected in shop on cast iron levelling plates and carefully inspected before shipment.

*Write for Catalogue.*

**BRITISH MARKETS.**

London, Feb. 3rd, 1912.

According to "World's Paper Trade Review" the position in mechanical wood pulp continues perplexing. In spite of the reduced output, the market is very unsettled, and prices reflect the prevailing uncertainty. The market for chemical pulps continues firm, but business is still restricted.

The market for chemicals continues steady. Business is showing a little more activity, and shipments are fuller. The increasing cost of raw materials and coals is causing manufacturers some concern, these not being compensated by a corresponding rise in prices. Ammonia alkali, 58 per cent., is quoted £4 5s. to £4 10s., f.o.b. Liverpool; bleaching powder, £4 15s. per ton, f.o.b. Manchester; caustic soda (high-strength), £10 2s. 6d.; soda crystals, £2 12s. 6d.; and salt cake, £2 2s. 6d.

For home rags trade is fairly good, and prices have hardened. Prices for foreign rags are steady, and all grades are in good demand.

**SCANDINAVIAN MARKETS.**

"Farmand," commenting on mechanical wood pulp, says: The situation in the market is a peculiar one. In spite of the agreement as to restriction, the lock-out and the shortage of water,

the export of moist mechanical pulp from Norway to November 30th was in 1911 400,763 tons against 417,739 tons in 1910. Of last year's export 25,000 tons have, however, gone to the United States; and, while stocks were rapidly accumulating in 1910, they have been almost completely cleared out during the second half of 1911. The importation to Great Britain and Ireland in 1911 has been only 404,277 tons against 480,690 tons in 1910, and 427,515 tons in 1909. As the upper Baltic ports have been open for navigation considerably longer than in ordinary years, shipments have continued, and the pulp supply available by first open water from that quarter will consequently be so much reduced. English buyers are nevertheless holding back, and there is only a very limited business passing at present.



W. P. Gundy, of the Kinleith Paper Mills, has been elected vice-president of the Toronto Board of Trade.

The annual meeting of Wm. Barber & Bros., Limited, paper makers, Georgetown, was held on the 24th ult., when the old board of directors was re-elected. The annual meeting of the Canada Coating Mills, Limited, Georgetown, was held on the same day. There was no change in the directorate. The annual reports were considered satisfactory in both cases.

# TOWNSEND

## ELECTROLYTIC CELL

2,500-5000 AMPERE UNITS. ALKALI AND CHLORINE.  
CAUSTIC SODA. BLEACHING POWDER. CHLORINE  
FOR ORES. LICENSES GRANTED. CANADIAN PATENTS  
91939 - 105088 - 105089.

**HOOKER ELECTROCHEMICAL COMPANY**  
40 WALL STREET, NEW YORK

Telephone: 2726 BROAD.

Cable Address: "LAGERLOF NEWYORK."

# Scandinavian-American Trading Company,

PRODUCE EXCHANGE BUILDING, NEW YORK,

IMPORTERS AND EXPORTERS OF

FOREIGN AND DOMESTIC

# WOOD PULP

OF ALL KINDS

AND

# PAPER MILL SUPPLIES.

HANS LAGERLÖF, PRES.



# CROOKES, ROBERTS & CO.

SHEFFIELD ENGLAND

Makers of  
**Crucible Cast Steel**  
**Bed Plates**  
**Jordan Fillings**  
**Beater Bars**



Makers of  
**Bessemer Cast Steel**  
**Crookes' Composition**  
**Fillings**

And every description of Cutter Knives, Tools and Steel used and required in Paper Mills.

**ARGUS** High-Speed **STEEL** for fine machine tools is unsurpassed.

Once Used - Always Used

YOU SAVE MONEY USING "ARGUS" GOODS

WRITE US  
**ARTHUR P. TIPPET & CO.**  
 Agents for Canada MONTREAL

# SPENCER'S

ALWAYS



RELIABLE

Best Wool - Best Weave - Best Wear

**J H. SPENCER & SONS**  
**BURY ENGLAND**

Canadian Agents: **ARTHUR P. TIPPET & CO., MONTREAL**

# INDEX TO ADVERTISEMENTS.

(SEE CLASSIFIED ADVERTISERS INDEX ON PAGE XXVI.)

Ambursen Hydraulic Construction Co.....	lxv	Farrel Foundry & Machinery Co.....	xxxvii
Anderson, F. C.....	lviii	Fibre Development Co., The.....	lviii
Appleton Machine Co.....	vi	Finckh, Hermann.....	xxxiii
Ashdown, W. G.....	xlii	Garland, M. Co.....	xii
Atterbury Bros. Inc.....	lxii	General Supply Co. of Canada, Ltd.....	lv
Baker & Shevlin Co.....	vii	Gewerkschaft Sachtleben.....	xl
Becker & Co.....	xxxix	Gillespie, Geo. H. Co.....	lxv
Beloit Iron Works.....	xiii	Glens Falls Machine Works.....	iv
Bentley & Jackson.....	viii	Green Bay Barker Co.....	xxi
Bertram, James & Son., Ltd.....	xix	Hamelin, The, & Ayers Co., Ltd.....	lx
Bertram's, Limited.....	xlix	Hardy, Geo. F.....	lviii
Black-Clawson Co., The.....	xliii	Harmon Machine Co.....	v
Blethen, Hugh R.....	lix	Hay Knife Co., Peter, Limited.....	lxi
Bredt & Co., F.....	li	Holyoke Machine Co.....	xvi
Brunner, Mond & Co., Limited.....	lxvi	Hooker Electrochemical Co.....	xliv
Canada Coating Mills, Limited.....	lvii	Hough, R.....	lxvi
Canada Paper Co., Ltd.....	lvii	Howell Co., The.....	xlviii
Canadian Boomer & Boschert Press Co.....	lx	International Process Co.....	lii
Canadian Boving Co.....	xliii	Jeffrey Mfg. Co.....	iii
Carthage Machine Co.....	xxiv	Jenckes Machine Co.....	xvii
Castle, Gottheil & Overton.....	li	Johnson & Sons, Limited, C. H.....	xlxx
Chicoutimi Pulp Co.....	E.O.M.	Jones, E. D. & Sons Co.....	xxviii
China Clay Co.....	l	Kimball, Herbert S.....	lix
Christie, J. Co.....	lxvi	Klipstein & Co., A.....	l
Christie, Limited, George.....	lxv	Lawrence Pump & Engine Co.....	li
Crookes, Roberts & Co.....	xlvi	Lea, R. S. & H. S. Ferguson.....	lviii
Crossley, T. L.....	lviii	Little, Arthur D. Inc.....	lviii
Dallyn, Jardine & Co.....	li	Lyford, C. A. & Co.....	lviii
Dayton Globe Iron Works, Co.....	xxx	Mallandain, Albert E.....	xxxiii
Dean, F. W.....	lviii	Marx, J. & Co.....	v
DeCew, J. A.....	lix	Mardon, Alfred H.....	lx
Dillon Machine Co.....	xiv	McDougall, John, Caledonian Iron Works Co., Limited.....	liii
Dobler & Mudge.....	vi	Milne, Jas., and Son.....	xx
Dodge Mfg. Co.....	iv	Moore & White Co.....	xv
Dominion Belting Co.....	xlviii		
Douglas, J. M. & Co.....	lxv		
Eaton & Brownell.....	lviii		
Eastern Pipe and Construction Co., The.....	l		
Emerson Mfg. Co.....	xxvii		

## HYDRAULIC TURBINES

One unit of six with a total capacity of 13,100 Horse Power furnished for the new plant of J. R. Booth, Ottawa, Ontario. We build Turbines for any power for heads from 3 to 600 feet.

WRITE FOR CATALOGUE



**S. MORGAN SMITH CO.,**  
YORK - - PA.

New Brunswick Pulp and Paper Co., Limited.....lvi  
 Northern Engineering Works.....lxvi  
 Northern Mills Co.....lvi  
 Panzl Digester Lining Co.....lvi  
 Paper Makers Chemical Co.....lxi  
 Parsons Trading Co.....xxiv  
 Penman's Limited.....li  
 Perkins, B. P. & Son.....xxxv  
 Phillips, S. C. & Co.....xxviii  
 Porritt & Son, Joseph.....li  
 Porritt Bros. & Austin.....xlx  
 Prather, H. B.....lix  
 Preston's Digester Lining Co., Limited.....xxxiv  
 Pringle, T. & Sons.....lviii  
 Pullan, E.....liv  
 Pulp & Paper Trading Co., The.....lxi  
 Reddaway, F. & Co.....liv  
 Rice, Barton & Fales.....ii  
 Riordon Paper Co., Limited.....lvii  
 Ryther & Pringle.....xxxv  
 Sadler & Haworth.....xxxi  
 Sandy Hill Iron & Brass Works.....vii  
 Scandinavian American Trading Co.....xlv  
 Scott, Ernest & Co.....xli  
 Sherbrooke Machinery Co., Limited.....xviii  
 Smart-Turner Machine Co.....lxvi  
 Smith, S. Morgan.....xlvii  
 Snell, Samuel Co.....l

Spencer, J. H. & Sons.....xlvi  
 Stebbins Engineering & Mfg. Co.....lix  
 Sweezy, R. O.....lix  
 Swenson Evaporator Co.....xli  
 Ticonderoga Machine Works.....E.O.M.  
 Tippet, Arthur & Co.....xxvii-xlvi  
 Union Screen Plate Co.....iii  
 Union Sulphur Co., The.....lxi  
 United Wire Works, Limited.....xxvii  
 Valley Iron Works.....xxxvi  
 Vera Chemical Co.....lxii  
 Voith, J. M.....x  
 Walker, J. R. & Co.....lxii  
 Wallace, Jos. H. & Co.....lix  
 Walmsley, Charles & Co.....xxii-xxiii  
 Wandel, Chr.....xlii  
 Wandel Screen Mfg. Co.....ix  
 Waterous Engine Works Co., Limited.....lxiv  
 Wertheim & Co., A.....lxiii  
 Westbye, P. P.....xi-xxxi  
 Wilson, Paterson & Co.....lxvi  
 Winn & Holland.....lxvii  
 Woolford, G. Wood Tank Mfg. Co.....lxii  
 Zarembo Co.....liv

**KRAFT PULP**



The best Pulp for making

**KRAFT BROWN PAPER**

Sole Selling Agents, United States  
and Canada

**THE HOWELL CO.**

8-10 Wellington St., East

**TORONTO - CAN.**

**MAPLE LEAF**  
**STITCHED COTTON DUCK**  
**BELTING**  
**DOMINION BELTING CO. LTD.**  
**HAMILTON CANADA**

**HAVE YOU GOT YOUR COPY OF THE  
 PAPER MAKERS' POCKET BOOK?  
 SEE PAGE LIV.**

# BERTRAMS, LIMITED

## Papermakers' Engineers

St. Katherine's Works,  
SCIENNES, EDINBURGH.

The Newest and most Up-to-Date Machinery for Papermakers,  
embracing British, American and Continental Improvements.

The J. L. MORRISON CO., Agents in Canada,  
445-447 King Street West, TORONTO

---

**C. H. JOHNSON & SONS, Ltd.**

WIRE WORKS, — ST. HENRY, — MONTREAL.

MANUFACTURERS OF

Fourdrinier Wires, Cylinder Wires,  
Brass, Copper and Iron Wire Cloth, Dandy Rolls

---

# PORRITT BRO<sup>R</sup>. & AUSTIN

Stubbins Vale Mills—RAMSBOTTOM—near Manchester, England.

Manufacturers of every description of

***Felts and Jackets for  
Pulp and Paper Mills.***

Agents for Canada: C. H. JOHNSON & Sons, Ltd., ST. HENRY, MONTREAL.

**We Manufacture** Wooden Water Pipe for Water Works Systems. Specially  
 Made Pipe for conveying Chemicals. **Continuous Stave**  
 Pipe for Power Plants. Sizes from 2' to 12' Diameter

**The Eastern Pipe and Construction Co.,**  
**Alexandria, Box 329 Ontario.**

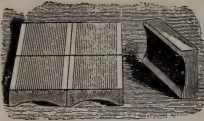

### Use Snell's Drainer Bottoms

They drain quickly and don't let the Pulp go into  
 River. **No Dust. No Splinters. Clean Stock.**

*Send for Sample and Price.*

**Samuel Snell Co., - Holyoke, Mass.**

Cable Address:—"Kaolin, Manchester." A.B.C. Codes 4th & 5th Edition

# CHINA CLAY CO.

JOHN WILLIAMSON, Manager.

4 St. Anne's Square

**MANCHESTER, ENG.**

**MINES**—Ruddle, Bojea, Colchester, South Ninestones, Tronance, St. Austen  
 Cornwall.

**CONTRACTORS TO H.M. INDIAN GOVERNMENT**

Canadian Representatives—G. A. Meincke & Co., 222 Coristine Bldg., Montreal.

## A. KLIPSTEIN & Co. Ltd.

(OF CANADA)

12 ST. PETER ST. - - MONTREAL

# SULPHATE ALUMINA

**CHINA CLAY, BLEACH and CASEIN**  
**PAPER BLUE, both Basic and Acid**  
**AURAMINE - RHODAMINE**

and all other Aniline Colors

Shades Carefully Matched in our Laboratory Mention Pulp & Paper Magazine

**New York Office - 129 Pearl Street**



# LAWRENCE PUMP AND ENGINE CO.

P.O. BOX 70, DEPT. 10  
LAWRENCE :: MASS.

## CENTRIFUGAL PUMPS

We make an exclusive specialty of High Efficiency Centrifugal Pumps for Paper and Pulp Mill. In one mill 49 of our Pumps are running, the customer writes—"Your Pumps are all giving perfect satisfaction."

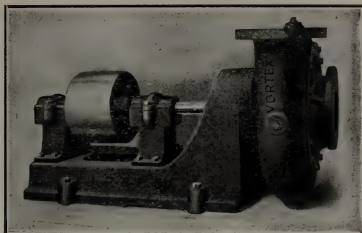

ESTABLISHED 1808.

REGISTERED.

TRADE MARK.

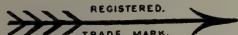

# FELTS For Pulp and Paper Mills.

## JOSEPH PORRITT & SONS

HELMSHORE

Manchester, England.

Agents for  
Canada  
and United  
States.

All kinds  
Woollen, Lin-  
en and Cotton  
Cloths for  
Mechanical  
Purposes.

F. BREDT & CO., 240 Water Street, NEW YORK.

# PENMANS LIMITED

ST. HYACINTHE, QUEBEC

Manufacturers of

PULP AND PAPER MAKERS' FELTS,  
JACKETS, STRAINER CLOTHS, ETC.

Special sizes and qualities made to order. Satisfaction guaranteed.

DALLYN, JARDINE & CO. TORONTO Selling Agents

# CASTLE, GOTTHEIL & OVERTON

200 Fifth Avenue, New York

AGENTS FOR

## Sulphite and Wood Pulp Mills

Dealers in all kinds of Paperstock, Sizing, etc.

Correspondence Solicited.

THE PROCESSES AND APPARATUS  
THAT MADE "KRAFT PAPER" SUCCESSFUL



CABLE ADDRESSES  
KRAFTLICH, NEW YORK  
INPROKRAFT, LONDON.

AMERICAN OFFICES  
5 BEEKMAN STREET  
NEW YORK, N. Y.

EUROPEAN OFFICES  
SALISBURY HOUSE,  
LONDON, ENGLAND.

SOLE AGENTS IN NORTH AMERICA  
FOR  
CARL P. CARLSON, SWEDEN.  
EVAPORATORS AND LIQUOR SYSTEMS.

JULIUS PINTSCH, ACTIENGESELLSCHAFT, GERMANY.  
DIGESTERS, DIFFUSERS AND SPECIALTIES.

SWEDISH SYSTEM OF RECOVERY FOR  
TURPENTINE, ALCOHOL AND OTHER BY-PRODUCTS.

INTERNATIONAL PAPER PROCESS CO.

ENGINEERS, CHEMISTS, PULP EXPERTS.

# TURBINE PUMPS

SPECIALLY DESIGNED TO SUIT  
THE CONDITIONS OF OPERATION

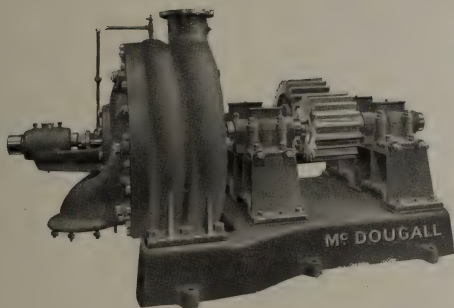

THIS SIX INCH TURBINE PUMP, GEARED TO A WATER  
WHEEL, *CHICOUTIMI PULP COMPANY*, HAS A  
CAPACITY OF 833 IMPERIAL GALLONS  
PER MINUTE, AGAINST A  
FIRE PRESSURE  
OF 100 LBS.

---

**Works: 512 William Street, Montreal**

---

**THE JOHN McDOUGALL,  
CALEDONIAN IRON WORKS CO.,  
LIMITED**

Nearly FIFTY YEARS ago we introduced this Belt. IT HAS STOOD THE TEST OF TIME

2" to 24" in stock

Every Belt is  
Stamped with  
Trade-Mark.



Write or phone us

Beware  
of Imitations

SOLE MAKERS

F. REDDAWAY & CO.,

MONTREAL, CANADA.

**E. PULLAN,** 490 Adelaide St. W.,  
TORONTO

Largest Paper Stock Dealer in Canada

**RAGS AND PAPER STOCK GRADED TO SUIT MILL REQUIREMENTS**

Correspondence Solicited.

## EVAPORATORS

Zarembo Patent Multiple Effects

FOR RECOVERY OF

# SULPHATE OR SODA

*"Not the excellence of yesterday, but the excellence of to-day"*

ZAREMBA COMPANY

Buffalo, U.S.A.

SECOND AND ENLARGED EDITION

# THE PAPERMAKERS' POCKET BOOK

Specially Compiled for

PAPER MILL OPERATIVES, ENGINEERS, CHEMISTS,  
AND OFFICIALS

By JAMES BEVERIDGE

- ¶ This new edition contains more exhaustive chapters on Raw Fibrous Stock, such as Cotton and Linen Rags, Esparto, Bamboo, Megass or Crushed Sugar Cane, etc.
- ¶ The chapter on Wood Cellulose Manufacture by the Soda, Sulphate, and Sulphite methods has been amplified. Very complete information has been given of Soda Recovery, Causticising and Composition of Recovered Soda Liquors.
- ¶ A new but brief chapter has been added relating to Loading Materials.
- ¶ The chapter on Chemical Analysis has been enlarged.
- ¶ It will be found that the additional matter is given in concise form, is of a highly practical nature, and is not generally found in English text books.

PRICE, \$3.50

**BIGGAR-WILSON, LTD., TORONTO**

# VI-BALATA BELTING

Is made in all widths up to 50 inches, and in any thickness from 3 ply to 24 ply. Is absolutely waterproof and not affected by extremes of temperature. Has great strength and durability, and is practically stretchless.

A recent test made by the well-known Testing Engineers, Messrs. Kirkaldy & Sons, London, Eng., gives the following result:

**6-inch 4-ply broke at 13,000 lbs.**

OR

**9,000 lbs. per square inch**

**LARGE STOCKS CARRIED AT ALL BRANCHES**

---

---

SOLE AGENTS:

**THE GENERAL SUPPLY CO.,**

OF CANADA, LTD.

**356-58-60 SPARKS ST., - OTTAWA, ONT.**

115-125 Adelaide Street West, TORONTO

WOODS WESTERN BUILDING, Cor. Market & Louise Sts., WINNIPEG MAN.

FLECK BROS., LTD., 443 Pender St. West, VANCOUVER, B.C.



## THE NORTHERN MILLS COMPANY

**Paper Manufacturers. Printing and Writing Papers.**

Super-Calendered, Velvet and Machine Finished Book, Litho and Antique Printing, Engine Sized Writing and Envelope Papers, White and Tinted Bond. Typewriter Papers (Glazed and Rough Finish). Writing Tablets and Envelopes.

Ask for "Canadian Bond," "Provincial Bond," "Adelia," and "Northern Mills."

**Head Office:**

**Montreal, 278 St. Paul Street.**

**Mills:**

**St. Adele, Que.**

## Genuine "KRAFT" Papers MADE IN CANADA

**THE NEW BRUNSWICK PULP & PAPER CO., LTD.**

**Springfield Mills, Millerton, N.B.**

**TORONTO, 145 Wellington St. W.**

**MONTREAL, 404 St. Nicholas Bldg.**

## PANZL'S PATENTED LINING COMPOSITION

IS THE SAFEST AND BEST MATERIAL FOR

**LINING OF SULPHITE PULP DIGESTERS**

AND ACID RECLAIMING TANKS

**PANZL LININGS ARE SAFEST AND  
MOST DURABLE**

They are really acid-proof and practically indestructible.

All Digesters lined with Panzl's patented composition, now as tight and in as good condition after years of continuous use as they ever were, no leaks and no repairs.

Panzl Linings can be made considerably thinner than the other linings, thus increasing the capacity of the digesters.

The composition and the system of constructing of Panzl Linings are patented in all countries where wood pulp is being manufactured by the sulphite process. The PANZL U.S. Patents have been adjudicated to be valid in law and wholly independent of all prior patents relating to linings of digesters.

For information and estimates, address:—

**PANZL DIGESTER LINING COMPANY**

**505 Washington Ave., Muskegon, Mich.**

## The Riordon Paper Company, Limited

Fibre, Paper, Lumber.

MONTREAL - CANADA

News Paper, Hanging Paper, Wrapping Paper, Building Paper,  
Celebrated "Impervious" Spruce Sheathing and Sulphite Fibre for all  
kinds of Paper.

## THE CANADA COATING MILLS, Ltd.

GEORGETOWN, ONT.



Manufacturers of  
SURFACE COATED BOOK and LITHOGRAPHIC  
PAPERS COATED CARDBOARD and COATED  
BOXBOARDS of every description.

### "Chalk White" Coated Book Paper.

The best and whitest coated paper sold.

**ALL REGULAR SIZES AND WEIGHTS IN STOCK.**

Our Art Litho Cover Paper is stocked in four tints,  
2 sizes. 20x25 and 21½x28½. Samples gladly sent.

MONTREAL  
TORONTO

**CANADA PAPER Co.**  
LIMITED

WINDSOR  
MILLS, P.O.

# DIRECTORY

of

## Civil and Chemical Engineers

### T. PRINGLE & SON, Limited

Engineers and Architects

Plans and Specifications for Pulp and Paper Mills, Power Plants and other Industrial Works.

Bell Telephone: Main 3890.

Cable Address: "Pringleson."

Coristine Bldg. Montreal

### R. S. LEA, and H. S. FERGUSON, ENGINEERS

Pulp, Paper and Chemical Fibre Mills.

Water Power Development and Trans-

mission. Steam Power Plants.

Telephone Long Distance Up. 751.

405 DORCHESTER ST. West, MONTREAL

### Arthur D. Little Inc.

— LABORATORY OF —  
ENGINEERING CHEMISTRY

93 BROAD ST., BOSTON, - MASS.

Our staff includes experts in Papermaking Chemistry  
—Sulphite Mill Practice—Fuel Engineering.

### GEORGE F. HARDY, M. AM. SOC., M. E. M. CAN. SOC. C. E. Consulting Engineer.

Paper, Pulp and Fibre Mills, Examination of  
Mill Properties, Water Power Developments.

Mutual Reserve Building, - 309 Broadway,  
NEW YORK.

CHARLES E. EATON, JAMES P. BROWNELL,  
M. Am. Soc., M. E. C. E.

### EATON & BROWNELL, Consulting Engineers and Architects.

Paper, Pulp and Fibre Mills, Water, Steam and  
Electric Power Development, Examination of  
Properties, Consultation Reports.

SMITH BLDG. WATERTOWN, N. Y.

### F. W. DEAN, Mill Engineer and Architect

(Formerly of Dean & Main)

Exchange Building 53 State Street,  
BOSTON, Mass.

Paper and Pulp Mills. Steam, Hydraulic and  
Electrical Developments. Examinations and Reports  
of Projects.

### T. LINSEY CROSSLEY

*Engineering Chemist*

PULP AND PAPER  
TECHNOLOGY

318 Lagachetiere St., W., Montreal

### THE FIBRE DEVELOPMENT CO.

APPLETON, WIS., U.S.A.

*Engineers*

WATER POWERS STEAM AND ELECTRIC PLANTS  
PULP AND PAPER MILLS.

### FRED. C. ANDERSON

*Mill Engineer*

20 years practical experience in paper, ground  
wood and chemical pulp making. Steam

Hydraulic and Electrical development,

Examinations and Reports on both

old properties and new projects.

9-10 Strickland Bldg., CARTHAGE N.Y.

### FOREST ENGINEERS

FOREST SURVEYS TIMBER ESTIMATES LOGGING MAPS

WATER POWER WATER STORAGE

We are prepared to examine and report on Forest

Properties anywhere.

CLARK & LYFORD

403 Crown Bldg.

Vancouver,

LYFORD, CLARK & LYFORD

206 Board of Trade Bldg.

Montreal.

**PULP  
PAPER  
POWER** JOSEPH H. WALLACE & CO.  
INDUSTRIAL ENGINEERS.  
TEMPLE COURT BLDG. NEW YORK.  
SALISBURY HOUSE, LONDON, E.C  
CABLES, TRIPLEX, N. Y., TRIPLEX IS, LONDON.

**J. A. De CEW**

M.A. INST. CHEM. ENG.  
A.M. CAN. SOC. C.E.

Paper Mill Analysis.

Sulphite Fibre

Pulp Testing

**Chemical  
Engineer**

Soda Fibre

Investigations.

Reports

**Canadian Express Building MONTREAL.**

HERBERT S. KIMBALL, S.B., M. Am. Soc. C.E. — R. O. SWEEZEY, B.Sc., A.M. Can. Soc. C.E.  
Chemical Engineer and Mill Architect. Civil and Forestry Engineer.

**Chemical and Mechanical Pulp & Paper Mill Engineers**

Canadian Timber Lands and Waterpower Development  
Consultations solicited on Canadian exploitation.

**Metropolitan Building, QUEBEC, Canada.**

Power, Lighting, Heating, Ventilating and Drying.—Complete New Plants, Improvement of Old Plants;  
Plans, Specifications, Contracts, Estimates, Tests, Appraisals, Inspections and Reports.—Pulp, Paper,  
Box Board and Coating Mills.

Lowest

**H. B. PRATHER,**

Guaranteed

Possible

**CONSULTING ENGINEER,**

Results.

Operating Cost. **ROCKFELLER BLDG., CLEVELAND, O.**

**HUGH R. BLETHEN**

**21 PARK ROW, - - - NEW YORK, N.Y.**

Traveling Cranes - Overhead Tramways - Trolleys and Chain  
Hoists for Paper and Pulp Mills - Power Houses.

**Stebbins Engineering & Mfg. Co.**

**WATERTOWN, N.Y.**

MANUFACTURERS OF

STEBBINS' ACID SYSTEMS, SULPHUR BURNER  
DIGESTER LININGS, RECLAIMERS, ETC.

Engineering Department  
under

Plans, Estimates and Specifications for Paper,  
Pulp and Fibre Mills,

Mr. T. L. TOMLINES

Water Power and Hydro-Electric Developments

# LEUNIG PAPER SCALES

Showing correctly at a glance, by weighing a single sheet, the weight of a ream of Paper of any size, containing either 480, 500, or 516 sheets.

Can also be made to indicate in addition to the English weight, the weight in Kilogrammes.

Illustrated Price List on Application.



$\frac{1}{2}$  to 80 lbs.

**Price,**  
**Ten Dollars**  
F.O.B., London

$\frac{1}{2}$  to 120 lbs.

**Price,**  
**Fourteen**  
**Dollars**  
F.O.B., London

Illustrated Price  
List on Application.

**Alfred H. Mardon** 150 Shaftesbury Ave. **London, Eng.**

# PULP · PRESSES

AND ACCESSORIES

## CANADIAN BOOMER & BOSCHERT PRESS Co., Ltd.

18 TANSLEY STREET, MONTREAL

“ LACHUTE FELTS ”

Bell Tel. No. 23

## The Hamelin & Ayers Co., Limited

LACHUTE MILLS, P.Q.

MANUFACTURERS OF EVERY DESCRIPTION OF

# FELTS FOR PAPER AND PULP MILLS

“ The Best are the Cheapest. ”



**BARKER  
CHIPPER  
PAPER-CUTTER**

**MACHINE** *Of Every*  
**KNIVES** *Description*

**THE PETER HAY KNIFE CO., LIMITED, GALT, ONT.**

**The PULP & PAPER TRADING CO.**

TEMPLE COURT BUILDING, NEW YORK CITY.  
DEALERS IN

**Paper and Pulp of All Kinds.**

Prices and Samples on Application.

REGISTERED



JOHN KNIGHT, Pres. C. K. WILLIAMS, Treas. C. H. KNIGHT, Sec.

**Paper-Makers Chemical Co.**

FROM MINE TO MILL

**ENGLISH CHINA CLAYS  
MANUFACTURERS**

**Excelsior Felt Cleaner**

GBB Brand China Clay is  
a natural pure white, no artificial tinting  
Unsurpassed for  
coating, bleaching, or fine papers.

Superior Rosin Size  
Superior Casein Size

**EASTON, PA., U.S.A.**

# **The Union Sulphur Company**

**Producers of the Highest Grade Brimstone on the Market**

Absolutely free from Arsenic, Selenium or Tellurium

**The Largest Sulphur Mine in the World**

**CALCASIEU PARISH, - LOUISIANA**

**Main Offices : Whitehall Bldg., 17 Battery Place  
NEW YORK**

## WE GUARANTEE OUR SIZINGS TO BE ABSOLUTELY CLEAN OUR VERA PAPER SIZE

is purest, strongest and highest free rosin size made. We can furnish you with an ideal rosin size and patented apparatus to use same.

## OUR VERA MILL SIZE

is the best soluble paper makers' rosin size made. Ready to use in cold or warm water in the ordinary way without apparatus. Gives better satisfaction and is more economical than mill made size.

Our sizings are cleaned by our new patented process and we guarantee this size to be absolutely clean, without the least speck of impurity in the same, preventing thereby black specks in the paper. We are shipping our size in barrels or tank-cars.

## VERA CHEMICAL COMPANY

Main Office and Western Factory  
NORTH MILWAUKEE, WIS.

Eastern Factory  
STONEHAM, MASS.

**J. R. Walker & Co.** Importers and Packers of **GRADED RAGS, PAPER STOCK  
ROPE BAGGING, ETC.**

WAREHOUSE, 35 COMMON ST., MONTREAL.

Also Manufacturers of Roofing and Building Papers. Leatherboard and Friction Board

Mills at Sault au Recollet, P.Q.

## ATTERBURY BROTHERS, Incorporated.

*Importers and Exporters.*

**Wood Pulp,** FOREIGN AND DOMESTIC **Rags AND Paper Stock**

Potter Building, 145 Nassau Street, New York City.

Cable address "AFFECTIVE," New York.

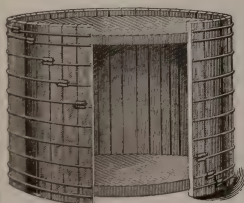

## WOOD TANKS

FOR PAPER MILLS,  
STUFF CHESTS,  
ACID TANKS,  
BLOW TANKS.

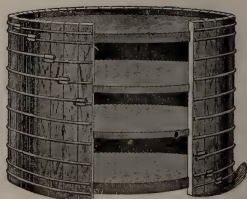

G. WOOLFORD WOOD TANK MFG. CO., 1429 CHESTNUT ST. PHILADELPHIA, PA.

# A. WERTHEIM & Co.

## HAMBURG

---

---

IMPORT AND EXPORT ALL KINDS OF

***Sulphite,  
Soda and  
Mechanical***

# WOOD PULPS

---

---

**OFFICES AT:**

CHRISTIANIA (Norway) ..	Kirkegaden No. 20.
GOTHENBURG (Sweden) ..	Lilla Kyrkogatan No. 20.
MANCHESTER .. .. .	Guardian Buildings (opposite Exchange).
LONDON .. . . .	77a Queen Victoria Street, E.C.
PARIS .. . . .	Rue de Londres No. 29.
ANGOULEME (France) ..	43 Rue Louis Desbrandes.
LYONS .. . . .	54 Cours Gambetta.
MILAN .. . . .	24 Via Solferino
TOLOSA (Spain) .. . .	18 Calle San Francisco.
NEW YORK .. . . .	99 Nassau Street.
ST. PETERSBURG .. ..	Little Podjascheskaja House, 4, Qu. 16.

---

---

**Telegraphic Address :**

**“WERTHEMO, HAMBURG.”**

*Over 70 sold since April, 1911*

When it comes right down to brass tacks, orders, and particularly *repeat* orders, are the best indication of the quality of a machine

## Quiller Centrifugal Screens

have been manufactured by us in Canada only since last spring. Already some 70 of the machines have been placed and we are busy filling the repeat orders our earlier installations have brought in.

**The Quiller Screen** has been tried out for many years in European mills. Of late years numerous installations have been made in the United States and Canada. Not only has it demonstrated its complete adaptability to American conditions but it has been acknowledged without superior in screening capacity and in economy of operation.

### **With Proved Maximum Capacity.**

Horizontal Type—12 to 14 tons Ground Pulp.

Vertical Type—12 tons Ground, 15 tons Sulphite Pulp.

### **Guaranteed Minimum Power Consumption.**

3/4 H.P. per ton capacity.

*Write us for full information and let us refer you to an installation in your neighborhood.*

**The Waterous Engine Works Co.,**  
**Brantford, Canada.** **Limited**

**Geo. Christie Ltd.** - -

**Glasgow,  
Scotland**

# FOURDRINIER MACHINE WIRES

Unequaled for Strength, Smoothness and Long Life.

## CYLINDER COVERS

Canadian Agents:

**J. M. Douglas & Co., St. Nicholas St., Montreal.**

# CANADIAN TALC FILLER

**GEO. H. GILLESPIE COMPANY**

**MADOC - - - ONTARIO**

*The only Manufacturers of Paper Filler in Canada.*

Our Filler is used in Canada, United States, England, Germany, Austria, Holland, Russia and Scandinavia.

# AMBURSEN HYDRAULIC CONSTRUCTION CO.,

OF CANADA, LIMITED,

**405 Dorchester St. W. - Montreal.**

(Associated with the Ambursen Hydraulic Construction Co., of Boston, Mass.)



## Concrete Steel Dam

OF THE

**MISSISQUOI PULP CO.,**

**Sheldon Springs, Vt.**

Mid-channel, height 40 feet  
Total length 270 feet (only  
180 feet shows in the pic-  
ture, the remainder being  
concealed at the left.)

Dam specially designed to  
withstand heavy ice gorges.  
Factors of safety are calcu-  
lated for a 12-foot flood.

**IF YOU HAVE A DAM TO BUILD, WRITE US NOW.**



Every Grade of Waste for  
Paper Making.

# R. HOUGH,

LONDON, England.

Agent for Canada and U. S.,

**THE J. CHRISTIE CO.**

5 King St. West, TORONTO, Canada.

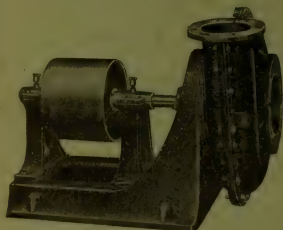

Steam and Power Pumps, Condensers, Travelling Cranes, etc. We also manufacture Triplex Stuff Pumps.

*The*

**Smart-Turner Machine Co.**  
LIMITED  
Hamilton, - Canada

Cranes and Hoists for Paper Mills and Power Plants



155



121c



156

NORTHERN ENGINEERING WORKS, 25 Chene Street - DETROIT, Mich.  
ADVANCE MACHINE WORKS, LTD., Manufacturers for Canada, Walkerville.

**HIGH  
TEST**

# BLEACHING POWDER

35/38%

(BRUNNER MOND & CO'S.)

THE STRONGEST AND THEREFORE THE CHEAPEST  
WINN & HOLLAND, Limited, MONTREAL

# PULP AND PAPER MAGAZINE OF CANADA

VOL. 10, TORONTO, MARCH, 1912, NO. 3

## PRINCIPAL CONTENTS

Paper Specialties.  
Fest as a Paper Material.  
Pulpwood Statistics.  
Conservation of Water Power.  
Fest in Paper Making.  
Degradation of Pulp During  
Storage.  
Sanction of Starch in Paper.  
New Canadian Patents.  
Pulpwood Consumption in  
Canada.  
New Incorporations.  
Pulp and Paper News.

Established 1837

Incorporated 1867

# RICE, BARTON & FALES

## MACHINE & IRON CO.

CHARLES S. BARTON, Prest. & Treas.  
GEORGE S. BARTON, Secretary.

WORCESTER, MASS.

BUILDERS OF

**Modern Fast Running and Heavy Four-  
drinier and Cylinder Machines for Making  
Paper, and Drying Pulp.**

Double Drum Vertical Winders and Re-Winders.

Upright and Revolving Reels.

Large and Heavy Wet Machines.

Revolving Cutters and Layboys.

Hill Patent Diagonal Cutters, which can be equipped with  
Slitting Arrangement, and Reeling Off Bars.

Chilled Iron Calender Rolls.

Screens and Screen Plates.

Stuff, Suction and Fan Pumps.

Patent Top and Double Edged Slitters.

Pneumatic Re-Winders for Small Rolls.

Additions and Changes made to Old Paper Machines  
Greatly Increasing Speed and Capacity.

## Sulphite Mill Specialties

# Jeffrey Wire Cable Conveyers



for handling material in Pulp and Paper Mills are more economical in operation, and cost less to install and maintain than any other type of Conveyer.

Jeffrey Conveyer handling bundles of Wood Pulp in a Paper Mill.

We also build Chain Conveyers for handling logs, Storage Battery Locomotives, Power Transmission Machinery, Chains, Pulp Lap Shredders, etc. Write for latest catalogs.

## The Jeffrey Manufacturing Company

Canadian Works and Main Office—  
MONTREAL. 3-1-12

Branch Office—  
WINNIPEG.

E. J. WELCH, *President and Managing Director*  
HENRY W. S. DOWNS, *Superintendent*

EMMONS CROCKER, *Vice-President*  
A. S. MORSE, *Secretary and Treasurer*

# SCREEN PLATES



The "Union" Bronze (best phosphorized cast metal) Plates for Sulphite Mills. The Standard Rolled Brass Plates. The "Union" Cast Metal Suction Plates.

We carry a large stock of blanks of the various sizes in both metals and can fill all orders promptly.

Old plates reclosed and recut by our process are practically as good as new and give better results than by any other process.

## Union Screen Plate Co. of Canada, Limited

FACTORY: LENNOXVILLE, QUEBEC.

OFFICES: Lennoxville, Quebec, and Fitchburg, Massachusetts, U. S. A.

# Glens Falls Machine Works

GLENS FALLS, N.Y.

Sole Manufacturers of

**Tromblee & Paull Rotary Sulphur Burner**

**The Moore Rotary Screen**

**The Reynolds Screen**

Also Manufacture

**Cedar Point Foundry Grinders**

**Improved Standard Grinders**

**Improved Wet Machines**

**Rotary Pumps, etc.**

Write for Particulars and Specifications—they are free.

# DODGE

**Transmission** —\*

—\* **Machinery**

— **High Grade Only** —

**Shafting, Hangers, Pulleys,  
Friction Clutch Pulleys.**

## DODGE MANUFACTURING CO.

640 ST. PAUL ST. HAYMARKET SQUARE MONTREAL LIMITED



**J. Marx & Co., = = London, E.C., England**

**Double Beaters with 1 Basalt Lava Roll and 1 Steel Roll in Concrete Beater Troughs, greatly improve quality of paper, especially News.**

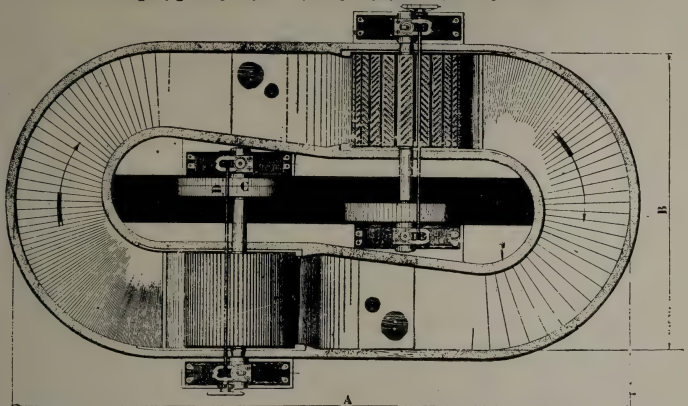

**SPECIALITIES:** Margalt Suction Rolls, Basalt Lava Stone Beater Rolls, Stone Wet Press Rolls, Basalt Lava Pulp Refiners for Screenings.

Canadian Representative

**Judson A. DeCew**

Canadian Express Building

**Montreal**

*The*

# Harmon Incline Screening System

Will give greatest capacity.

Will give cleaner stock.

Will save power.

Will save labor.

Does not require use of Rakers.

Write us for full descriptive Catalogue and testimonials from the best mills in the country.

## **HARMON MACHINE COMPANY**

**WATERTOWN, N. Y. U. S. A.**

## THE EDDY PAPER TESTER

Will register the breaking strength of paper in pounds per square inch—a recognized standard the world over.

**\$15.00 net**  
postpaid.

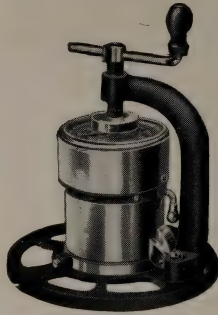

Is provided with an adjustment whereby the user can reset same, if necessary. Will do the work of higher priced machines and do it quicker. 6 inches high.

**DOBLER & MUDGE**

BALTIMORE, MD., U.S.A.

## THE BEST JORDON ENGINE IS BUILT BY THE

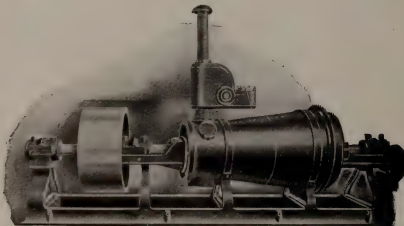

**APPLETON MACHINE CO.**

APPLETON, WIS.

SEND FOR PARTICULARS

THE SANDY HILL IRON AND BRASS WORKS, HUDSON FALLS, N.Y.

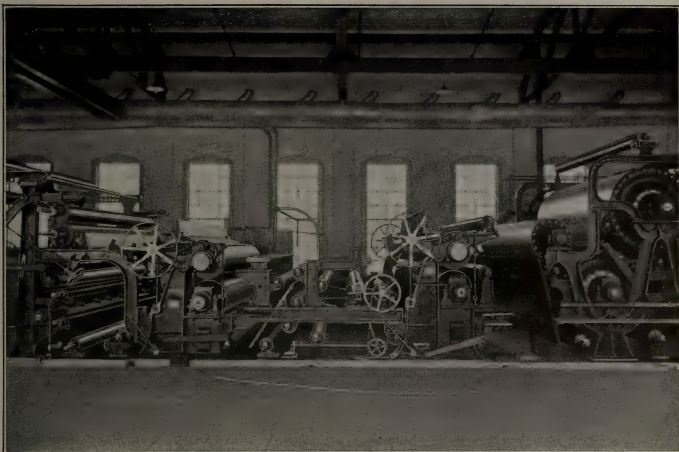

130" HARPER FOURDRINIER PAPER MACHINE.

This illustration is of the

**Ramsey Patent Single**

This valve is made also in what we call the **Double Pressure Type** where different pressures are used

**1 Pressure Grinder Valve**

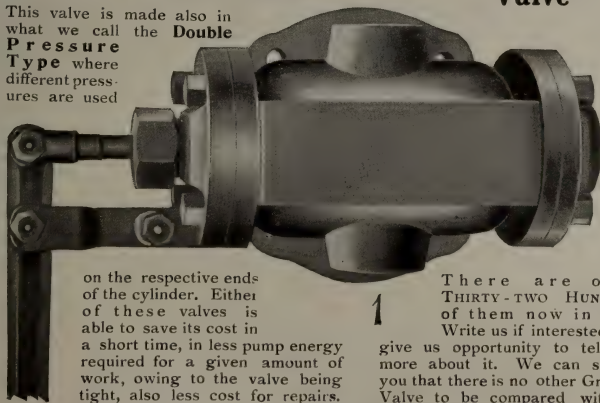

on the respective ends of the cylinder. Either of these valves is able to save its cost in a short time, in less pump energy required for a given amount of work, owing to the valve being tight, also less cost for repairs.

**1** There are over THIRTY-TWO HUNDRED of them now in use. Write us if interested and give us opportunity to tell you more about it. We can satisfy you that there is no other Grinder Valve to be compared with it.

Sole Manufacturers

**BAKER & SHEVLIN CO., - Saratoga Springs, N.Y.**

Telegrams :  
"CALENDER, BURY"

Telephone :  
NUMBER 340

# Bentley & Jackson,

Limited

PAPER MAKERS'

.. ENGINEERS ..

BURY, - - ENGLAND

*SPECIALITIES.*

MODERN HIGH SPEED NEWS PAPER  
MAKING MACHINES

SINGLE CYLINDER PAPER MAKING  
MACHINES

The NEW "*MARSHALL*" *PATENT REFINING ENGINE*, with separate adjustment to cones and discs,  
and our Patent Ball Thrust Bearing.

---

**APPLY FOR PRICES.**

---

OTTO WANDEL  
President

HERBERT H. MILLER  
Treasurer

# Wandel Screen Manufacturing Co.

WALPOLE, MASS., U.S.A.

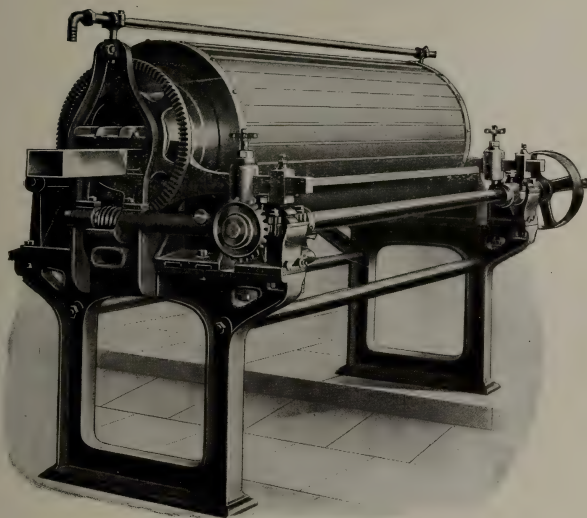

MANUFACTURERS OF THE

Quick Delivery.  
Write for Catalogue  
and list of users.  
We have no author-  
ized Agents in  
Canada.

# WANDEL ROTARY SCREEN

Over 200 Wandel  
Screens have  
been built and sold  
by us in the States  
within two years.

## SUPERIOR CONSTRUCTION



# J. M. VOITH

*Engineering Works and Foundries*

HEIDENHEIM o/Brz. (Wurt.)

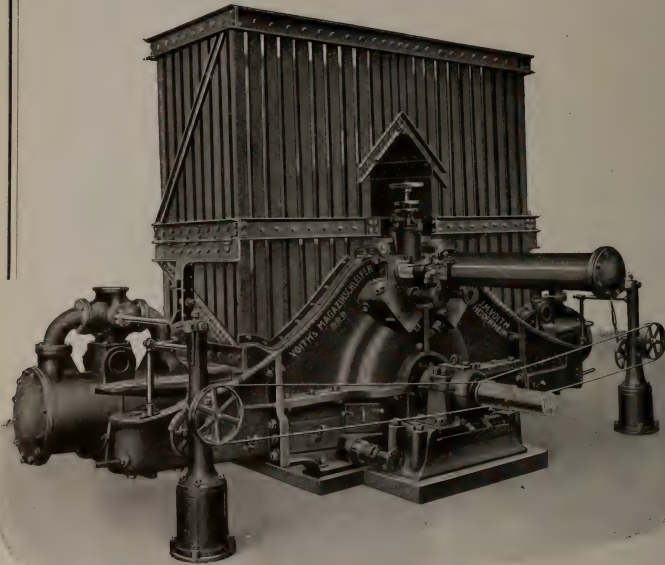

## VOITH'S MAGAZINE GRINDER

Patented in all principal countries.

Automatic Feeding and Reversing of Presses. 1 Grinder consumes up to 1000 H.P. Of more than 50 apparatus ordered, 25 already delivered and working most satisfactorily.

SPECIALITIES :

COMPLETE MACHINERY FOR  
WOOD PULP, PAPER **MILLS**  
AND SULPHITE

Branch Office for Canada and U.S.A., 1008 Fifth Ave. Bldg., New York.  
Representative : H. F. STORRER, C.E.

## The Improved "RUTH" Centrifugal Pulp Screen

To suit different conditions the "Ruth" is built as shown in the illustration, or with Steel Mitre Gears in a cast iron casing, independent of the footstep and running in oil, insuring long life of the gears.

It is also built **without gears**, using top pulley or motor drive. In this construction the screen plate sections can quickly be taken out and replaced through side doors.

All parts are easy of access, and no clogging of inlet or plates can take place.

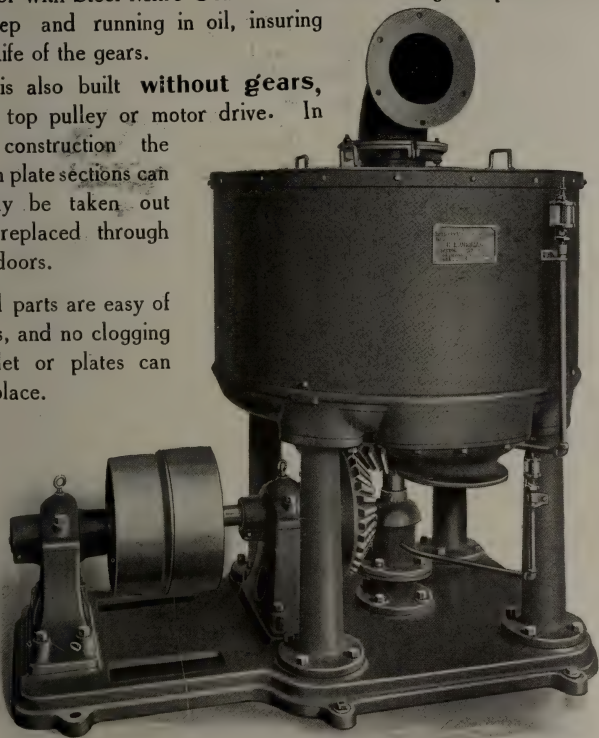

Other prominent features are—

- Simplicity of Construction.
- Small amount of power required.
- Great capacity and Low cost of maintenance.
- Lowest amount of fibre with the tailings.

In these respects this Screen is NOT surpassed by any other Screen in the market.

**P. P. Westbye, M.E., Peterborough, Canada**



**MOVABLE CRANE  
PULP LOG  
STORAGE SYSTEM  
AND UNLOADER**

---

---

**The M. Garland Company**  
BAY CITY, MICHIGAN

**Inventors of the Cable Conveyer**

# Have You Heard the Facts About The Beloit Machines?

---

---

One Fourdrinier built for 500 feet has run 615 feet, and averages 550 feet and makes 72,000 lbs. of print in 23 hours, 110 inch trim.

Another, built for 350 feet, for manillas, is running 490 feet every day on print.

Two others, built for 250 feet on book, are now speeded up to 340 feet on book.

A cylinder machine built for 40 tons of strawboard has made 89 tons in 23 hours, and averages 76 tons per day, dryers are 116 inch face.

---

---

## Beloit Iron Works

BELOIT, WIS., U.S.A.

# DILLON MACHINE CO

## BUILDERS OF PAPER MILL MACHINERY

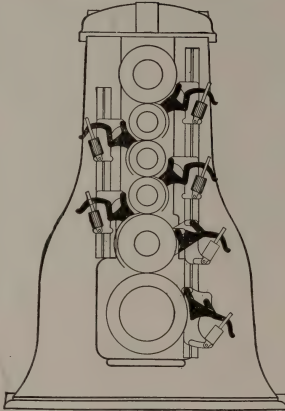

DILLON DOCTORS  
AND  
FEEDS

DILLON MACHINE CO.  
LAWRENCE MASS.

Beating Engines  
Washing Engines  
Jordan's Three Sizes—  
Single, Double & Triple  
Stuff Pumps, with  
Dillon Patent Valve  
Seating  
Brannan Patent Paper  
Folders  
Horizontal and Vertical  
Stuff Chests  
Single and Double Paper  
Cutters  
Backstands  
Plates, Knives and Bars

DILLON  
PATENT  
DOCTORS  
AND FEEDS  
MADE IN  
CANADA  
BY THE  
SHERBROOKE  
IRON WORKS,  
SHERBROOKE, P.Q.

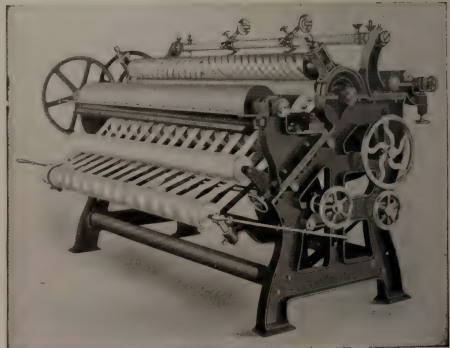

LAWRENCE, MASS., U.S.A.



---

# THE MOORE & WHITE CO.

PHILADELPHIA, PENN., U.S.A.

SEND FOR BULLETIN.

---

**V**ERY severe tests have been made of this winder, but all of them have exceeded expectations. The photograph shows the winder attached to our standard slitter part which takes up less room than any other slitter and has several very good features. The winder can be used as a rewinder by attaching a back stand to carry the roll which is to be rewound.

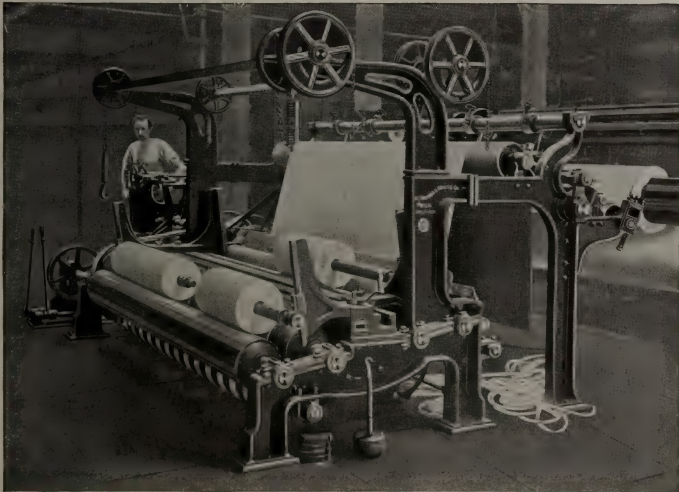

"M & W" Patented Four Drum Winder in operation.

**SATURATING, COATING AND WATERPROOFING  
MACHINERY**

**SPEED CHANGES**

**FRICTION CLUTCHES**

---

# HOLYOKE MACHINE COMPANY

HOLYOKE, MASS., U.S.A.

MANUFACTURERS OF

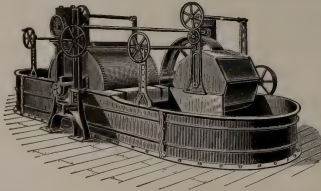

Washing and Beating Engines with  
Patent Double Hoist and Tubs of either  
wood or iron.

Hydraulic Pumps and Presses.

Rag Cutters and Rag Dusters.

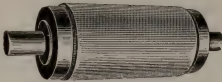

Cotton and Paper Rolls with Patent Fastenings.

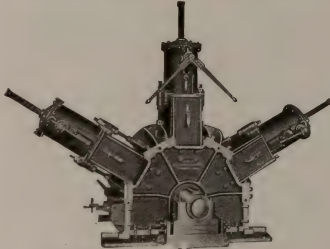

Patent Improved Wood Pulp Grinder.

Elevators, Rotary Fire Pumps and  
Friction Gearing.

Gears Accurately Spaced and Planed.

Shafting, Pulleys and Mill Work.

Machinery for Wood Pulp and  
Paper Mills.

Vertical and Horizontal Water  
Wheels with Flumes and  
all connections.

Wood Barkers, Wood Chippers  
and Wet Machines.

## Newest Designs

AND

## Highest Efficiency

Calenders. All kinds of Super-  
Calenders, Friction Calenders  
and Platers.

Chilled Iron Rolls.

Special Machinery

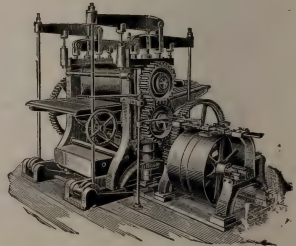

**Description and Estimates Furnished; also Gear List  
and Catalogs sent on application.**

# Pulp Wood Barker Bache Wiig Patent

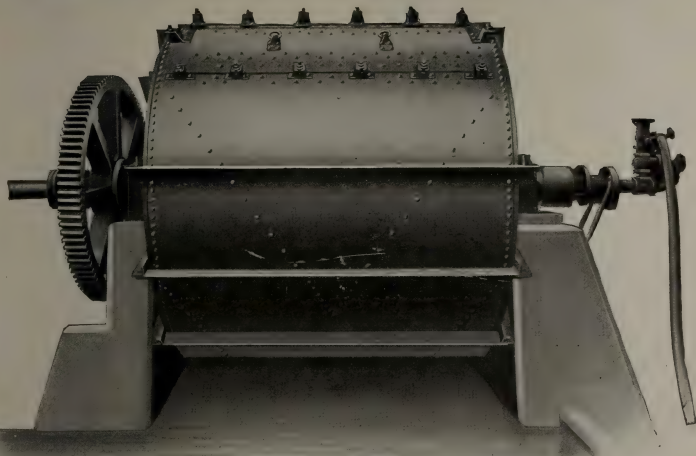

### THE LOSS WITH BARKING DRUM

Round wood covered with bark	-	-	-	8%
Slabs	-	-	-	23.8%
Edgings	-	-	-	9.4%

### LOSS WITH KNIFE BARKER.

Round wood covered with bark	-	-	-	22 to 24%
Slabs	-	-	-	50%

## The Jenckes Machine Co., Ltd.

General Offices: Sherbrooke, Que.

Factories: Sherbrooke, Que., St. Catharines, Ont.

Sales Offices: Sherbrooke      Montreal      St. Catharines  
 Porcupine      Cobalt      Rossland      Vancouver

JAMES BERTRAM & SON, LIMITED

LEITH WALK,

EDINBURGH, - - - SCOTLAND

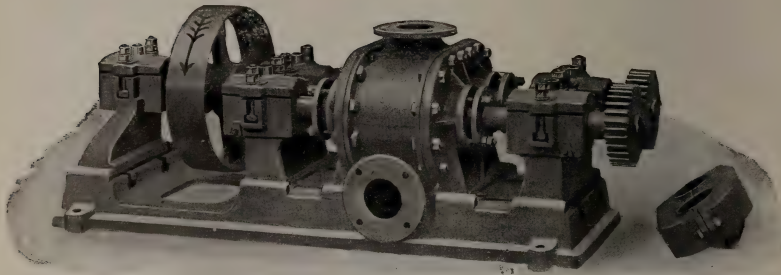

## Rotary Drum Pump

Specially designed for Paper Making Machines

---

Speciality: PAPER MAKING MACHINERY

---

Full Particulars on Application.

Telegrams: BERTRAM, LEITH.

---

---

# Battery Machines

(Save-Alls and Pulp Thickeners)

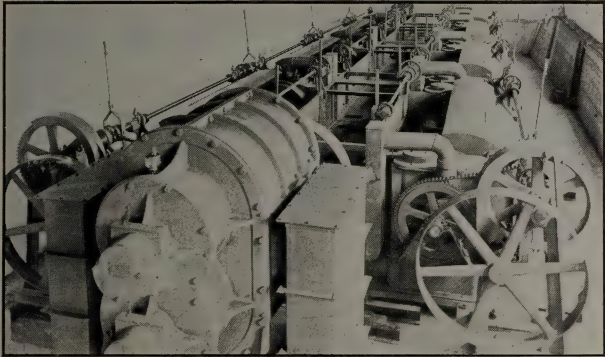

These pneumatic machines are operated in compact rows, by one blower, and by one line of shaft to each row. They have positively standardized the processes of thickening pulp and extracting stock from waste water.

Their operation is automatic, and is automatically maintained at the desired rate or density of output.

Their delivery is continuous, and the operation of the entire battery is in plain view, unobstructed by top gear or overhead connections.

No other class or make of pulp mill machinery affords the operative or the superintendent such a chance to keep his work up to the standard, without waste of time, power or stock.

---

SEND FOR FULL DESCRIPTION

---

## Sherbrooke Machinery Company

Limited

SHERBROOKE

. . .

QUEBEC



TELEGRAMS } MILNE, EDINBURGH  
 CABLEGRAMS }

Code A B C 4th & 5th Editions.

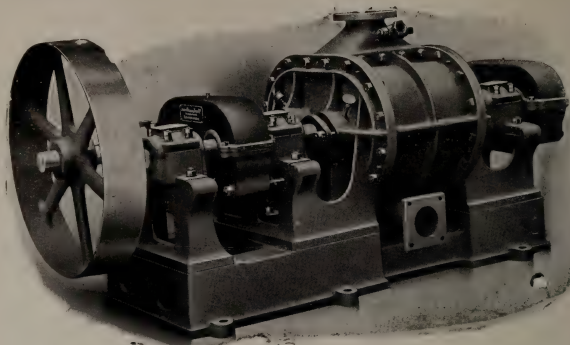

# HIGH DISPLACEMENT VACUUM PUMP

*(Made in Various Sizes)*

Suitable for

SUCTION ROLLS or VACUUM BOXES

MANUFACTURED BY

**JAMES MILNE & SON, LIMITED**

MILTON HOUSE WORKS, EDINBURGH

*DESIGNERS  
 AND  
 MANUFACTURERS  
 OF HIGH CLASS  
 PAPER MILL  
 MACHINERY*

*FAST RUNNING  
 PAPER MILL  
 MACHINERY  
 A SPECIALTY  
 LEAST VIBRATION  
 LEAST BREAKAGES*

*Don't Touch Your Mill Equipment Without Trying Milne.*

— — —  
WHOLESALE LUMBER YARD  
BURLINGTON, Vt.  
— — —

*J. R. Booth*  
*Manufacturer!*

— — —  
LUMBER  
PULP AND PAPER  
— — —

*Ottawa, Ont.* Dec. 8th, 1910

The Green Bay Barker Co.  
Green Bay,  
Wis.

Dear Sirs,

In reference to the Rotary Pulp Wood Barker.

I have four of these in operation, and I find them very satisfactory, particularly on small or crooked wood, and I find quite a saving over the old style of Barkers; they will also do considerably more work. As far as I know there have not been any repairs required on mine since I got them. I can recommend them to any one requiring a good Barker.

Yours truly,

*J. R. Booth*

**WALM**

**High-speed Paper**

175 INCHES

**MAKING PAPER**

**600 FEET PER MINUTE**

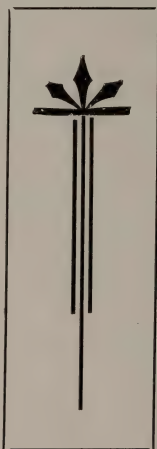

without Friction Clutch

**CHARLES WALM  
BURY, LA**

Estimates Given for Complete Paper-Making Plants.

# SLEY'S

## making Machines

WIDE ARE

ER AT OVER

ER MINUTE

es or Gear Wheels

### SLEY & CO., LTD.

### NCASHIRE

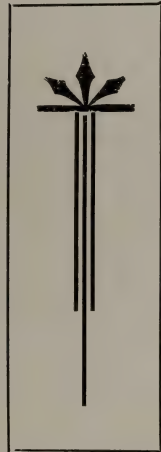

Codes : McNeill's (1908 Edition) Western Union, Bedford  
McNeill's A. B. C. 5th Edition

# Wilson-Paterson Co'y



127 BOARD OF TRADE BLDG., MONTREAL.

Agents for the United Alkali Co. of England

## OFFER TO THE TRADE:

Caustic Soda 60° to 78° Soda Ash, Caustic Potash, Sal Soda, Silicate of Soda, China Clay, Rosin size and a full line of Rosins, direct shipment from the south.

**Contracts made for regular supplies.**

## PARSONS TRADING COMPANY

EXPORTERS OF PAPER TO ALL PARTS OF THE WORLD

20 VESEY STREET, NEW YORK

BRANCH OFFICES AT

LONDON

SYDNEY

MELBOURNE

WELLINGTON

CAPE TOWN

BOMBAY

HAVANA

MEXICO, D.F.

BUENOS AIRES

**CORRESPONDENCE WITH MILLS SOLICITED**

# THE CARTHAGE CHIPPER

WILL INCREASE YOUR CHIPS. WILL  
DECREASE YOUR SAWDUST. By virtue  
of its Design and its Patent Feed Spout it takes a  
MINIMUM AMOUNT OF POWER.

---

Ask Anglo - Newfoundland Development Co.  
Ask Laurentide Pulp and Paper Company.  
Ask The Riordon Paper Company, Limited.

---

OR WRITE

**CARTHAGE MACHINE CO.**  
CARTHAGE, N.Y.



# Pulp and Paper Magazine of Canada

A Magazine devoted to the interests of Canadian Pulp  
and Paper Manufacturers and the Paper Trade.

SUBSCRIPTION PRICE: \$2.00 a year. Single Copies, 20 cents.

The Pulp and Paper Magazine is published on the second Tuesday of each month. Changes of advertisements should be in the Publishers' hands not later than the 1st of the month, and, where proofs are required, four days earlier. Cuts should be sent by mail, not by express.

PUBLISHERS:

BIGGAR-WILSON, LIMITED,

Confederation Life Building, Toronto, Canada

## PAPER SPECIALTIES.

In the report of the Specialty Division of the American Paper and Pulp Association, presented at the recent convention, an interesting distinction was made as to what does and what does not constitute a specialty. It does not mean ordinary white news, book, manila, fibre, or other standard grade of paper. "Manufacturers, however, know well when they are asked to quote on something outside of those lines, or even in those lines, when an unusual basis of weight or finish or color is asked for, that it then becomes strictly a specialty and should be treated as such," with a price commensurate with the trouble, cost and ability to make these special orders.

This is a point well worth making, but the specialties we are about to refer to are somewhat removed from this class. We believe an extraordinary development is at hand in the paper in-

dustry in lines which are only beginning to make themselves evident and in some cases have not even risen above the horizon at all.

In Europe, the mills turn out a great variety of special papers which are scarcely heard of in this country, such as Italian grocers' paper, a thin, heavily loaded product; reinforced paper, which is combined with some light textile fabric; "window" paper for wrapping small metal goods and protecting them from rust; asbestos paper, etc., etc.

The special feature we have more in mind, however, is the adjustment of the paper idea to meet the growing requirements of sanitation. The common drinking cup is already on the downgrade, many cities already having passed ordinances forbidding its use, an example which is being followed by some of the large corporations. The rational substitute is individual "cups" made of paper. Towels made of paper

are even more desirable, if possible. Wrappings for bread are becoming more and more popular. Paper receptacles for such eatables as oysters, butter, have long been in use, while for meats the only truly sanitary means of wrapping is some sort of a paper container which can be closed both ends and will be of sufficient consistency to carry for a considerable time without breaking open.

For clothing purposes, it is easy to believe that paper will unfold untold possibilities. It is a good non-conductor of heat, and the future, we believe, will show that it can be made at a price to permit of a garment being discarded as soon as soiled, surely a great desideratum in view of the dirt and disease germs collected in the mixed crowds of our cities. Already, we believe, the Chicago hospitals are making use of paper garments made from the bark of a species of mulberry. Wood pulp has over and over again proved its usefulness for textile manufacture as witness the "silk" ties, paper vests, and dozens of other articles made from it.

It will pay Canadian manufacturers to keep their eyes open to the possibilities presented by the use of paper for articles now largely composed of glass, woolen and cotton fibre, etc. It may be that the development along these lines will be some day of almost equal importance with newsprint.



#### PEAT AS A PAPER MATERIAL.

During the past ten years peat, among other vegetable fibres, has been discussed as a material for the paper industry, and much time and money have been spent on experiments in Europe

and America. The question is an important one for Canada, because if it can be proved that peat can be profitably turned into paper, then Canada would take first place in peat paper as she is destined to take first place in newsprint and other papers made from wood pulp. One geological authority estimates that Canada has 30,000,000 acres of peat bog, or 10,000,000 more than the United States, and much more than any European nation except possibly Russia, whose extent of peat areas is unknown. Dr. Eugene Haanel, Director of Mines at Ottawa, has great faith in the possibilities of peat as a fuel, as a gas producer, as a raw material for the manufacture of alcohol, for "moss litter" for stable use, for "peat mull," used largely in Germany as a deodorizer and disinfectant, and as a preservative packing for vegetables and fruit. Dr. Haanel sent Erik Nysbrom, a mining engineer, through Europe to report on the commercial uses of peat and he prepared a very interesting report, published by the Department of Mines in 1908.

With regard to the use of the sphagnum marsh peat the report admits that so far the use of peat, either with itself or mixed with wood pulp, has not been an economical success in the paper industry, and this view is confirmed by the article contributed to this number of the Pulp and Paper Magazine by Mr. Marx, of London, Eng. Mr. Marx has shown the same patience and perseverance in trying to work out the peat paper problem as he has in the application of basalt lava stone in the pulp industry, and in the course of years of experiments has accumulated quite a museum of samples and illustrations of processes in this field.

So far the accomplishments in peat paper have not been encouraging, largely for the reasons assigned by Mr. Marx, that there is such a small amount of fibre obtainable for the large amount of raw stuff handled, and that the fibre itself, being weaker than that made from other materials, has to be mixed with these other fibres to give it strength.

In the process invented by K. A. Zschorner of Vienna, and used at Frauenberg in Austria, the peat is chemically treated in a solution of alkali, not higher than 2° Beaume, and gradually decreased in strength by the addition of water. The material is then treated in another tank by a solution of calcium or sodium hypochloride of a strength not greater than 2° Beaume and under high pressure. It is then treated with a solution of alkali weaker than the first, but under greater pressure. After being washed the material is ready for use, either by itself or mixed with other fibres. Brin's process is both chemical and mechanical, the fibres of the peat being opened in a pair of rollers armed with teeth which open up the fibre and free it from the earthy and soluble matters. Subsequent operations squeeze out the coloring matter and the fibre is then bleached in tanks by oxygen gas or oxychloride of hydrogen, injected with steam, the after-treatment being with a solution of caustic soda at 5° to 6° Beaumé.

While peat fibre does not seem likely to replace wood and other fibres for newsprint or finer papers, especially since the introduction of Kraft papers, its use in the production of board is more hopeful, for while the cheapest material in the form of mixed paper stock now

costs about \$11 a ton, a serviceable board can be made with as much as 60 per cent. of peat fibre and this sixty per cent. can be supplied by peat at \$1.50. At a slightly increased cost 80 per cent. of peat can be used with 20 per cent. of rope fibre as a binding material. Since the field of board paper is steadily extending through the increased use of treated paper for wall decorations, for the manufacture of merchandize, "containers" for products shipped in packages, etc., the possibilities of peat as a material will assume importance and in another issue we hope to treat this special phase of the subject, based on experiments that have been made in Canada and the United States.



#### PULPWOOD STATISTICS.

Great interest attaches to the figures of the production and consumption of pulpwood in Canada, just issued for the year 1910 by the Dominion Forestry Branch and compiled by Mr. H. R. Macmillan, who has evidently taken pains to deal with his subject as exhaustively and completely as possible.

The quantity of pulpwood used by the fifty-one mills reporting was 598,487 cords, while the number of cords exported was no less than 943,141. A hasty calculation shows that if all this wood which was exported had been made into pulp here, it would have supplied material for 80 additional mills of the average size of those in Canada. Of the above quantity exported, 779,000 cords went from Quebec, or sufficient for 56 average-sized mills. In Ontario five additional

mills might thus have been operated, while relatively the greatest showing under such conditions would have been made by New Brunswick, for the 90,000 cords shipped away from that province would have been sufficient, if worked up at home, to supply five times the present actual number of mills.

About 23,600 cords less of pulpwood, or 3.8 per cent., was used in 1910 than in the year previous, but notwithstanding that, the total value of it increased by \$121,074. The average price of wood in 1910 was \$7.02 for Ontario or \$6.00 per cord for Canada, as compared with \$5.57 in 1909, when there had been a considerable decline. An interesting feature brought out by the figures is that in 1910 there was an increase of something over 100 lbs. of pulp produced from each cord of wood, owing presumably to the higher cost and consequent greater care and economy to get fullest possible results.

The falling off in spruce was mainly the cause of the smaller consumption of pulpwood, the decrease in this wood being responsible for 45,800 cords. Spruce still forms 78 per cent. of the total consumption, but in 1909 the percentage was 83 per cent. and in 1908, 87 per cent. Balsam, on the other hand, is coming to the front, for whereas in 1908 it formed 12 per cent. of the total, in 1909 it was 16 per cent. and in 1910, 20 per cent. Hemlock, which was reported by the Forest Bureau as a pulpwood for the first time as recently as 1909, was used five times as much in 1910, the soda process using most. Poplar fell off in importance owing to difficulties in working, etc. While in the United States we believe the proportion of ground wood, compared with

other forms of pulp, has shown a decreasing tendency, in Canada during 1910 the former more than held its own.

In 1910 it will surprise many to learn, no less than \$49,000 worth of pulp was imported into Canada, mostly from the United States.

In spite of the slight decrease in pulpwood production in this country in 1910, the export of pulp increased by over 48,000 tons. This export amounted to 69.3 per cent. of the total quantity produced, as against 63 per cent. in the previous year. The United States took 74.3 per cent. of the mechanical and 99 per cent. of the chemical pulp produced. Both mechanical and chemical pulp sent to the United Kingdom decreased.



#### CONSERVATION OF WATER POWER

The degree to which the practical application of the principle of conservation in connection with Canadian water-powers is needed, is indicated by a fact to which public attention in Montreal was recently drawn, namely, that if all the five power companies now in the field and four of which have already been granted franchises by the government for development of power in connection with the St. Lawrence and Ottawa Rivers carry out their present plans they would use the entire flow of the St. Lawrence, lower Lake St. Francis nearly three feet, and leave Cedar Rapids entirely dry. The matter came up at the annual meeting of the Montreal board of trade in the shape of a resolution deprecating the exploitation by individuals or corporations of the waters of the St. Lawrence for power purposes, and set-

ting forth its opinion that the conservation commission should be requested to draw up a comprehensive scheme for the preservation of the St. Lawrence and Ottawa Rivers as great natural waterways; also raising the question whether the Dominion Government should not establish a Hydro-Electric Commission to govern rates of power companies similar to the Board of Railway Commissioners, and possibly itself to develop and distribute hydro-electric power on lines similar to those followed in Ontario.

It is not to be wondered at that the people of Montreal, a city situate in a region of large and inexpensive water-powers, should feel that they ought to be in a position to take advantage of the opportunities thus presented for cheap electric power. The Conservation Commission has already, we believe, made a careful study of the St. Lawrence power question and here is certainly presented an admirable opening for it to show its value to the country, an attribute that nobody acquainted with its energetic personnel will think of denying.



—The water that has passed grinds no grist, but the slabs and trimmings of lumber camps in the year 1910, if ground up into pulp, would have produced as much groundwood as from 36,000 cords of wood. In the United States, about 6 per cent. of the whole production of mechanical pulp is from such waste material. But because this uneconomical lack of method has been going on in Canada, there is no real reason, now that its extravagance is recognized, why it should not be changed. W. Dick, of

Chatham, Ont., writing on this subject to the Canada Lumberman, says that there seems to be a lack of sympathy between sawmill owners and pulp manufacturers, and that both should be made to see that it is to their mutual interest that slabs should go to the pulp mills rather than to the fire. All lumbermen recognize the great destruction of material which goes on in "burners" all over the country, but have always considered it impossible to do anything else with the slabs and trimmings, as there was no demand for them on the spot and the cost of freight to any place where they might be utilized would be prohibitive. With the multiplication of pulp mills, however—and there are dozens of districts where they would be profitable enterprises—this state of things might be radically changed. Certainly sawmill and pulp mill owners might get together with benefit to both.



—President Taft in his recent message to Congress expressed approval of the suggestion to increase the postal rates on second-class matter, by which the rate on newspapers and magazines would be increased from 1c. to 2c. per pound. However, in these times of political uncertainty in the neighboring Republic, "approval" may remain merely that for some time to come. Should the suggestion be carried into effect there is no doubt of its effect upon the paper trade. Publishers, in order to curtail expense as much as possible, will cut down their paper requirements to the lowest limit. Weak publications may go to the wall altogether. Heavy-weight paper will be at a discount. Of course, subscribers



and advertisers will help to share the burden imposed by additional postage rates, but only to a limited extent, we believe. The first effect would be to curtail circulation, and anything which decreases the circulation of a publication lessens by so much its value as an advertising medium.



—The decision recently laid down by the United States Treasury Department that pulp or paper made in Canada from foreign raw materials is dutiable at the ordinary rate of interest, not so much on account of the principle laid down, for on that there was but little doubt in any case, but because of what it might lead to in the event of its being carried out to the letter. As generally understood, the intent of the order merely refers in particular to some paper made in this country from pulp imported from Sweden. But as the order in question prohibits free importation into the United States of paper from Canada made either wholly or in part from materials imported into the latter country from foreign sources, the question comes up, does this ruling mean absolutely and literally what it says? If so, it would bar the free importation into the United States of nearly all paper, because in practically all, there are small quantities of chemicals, etc., which have been imported into Canada from other countries. However, it is generally recognized that such an interpretation would be drawing the line altogether too fine, and that the intention is merely to charge regular duties on Canadian paper when such paper is made chiefly from foreign pulp.

## TESTING AND IMPROVING ROSIN SIZE.

(Continued from Last Issue.)

The residue remaining in the flask, consisting of the unsaponifiable matter, is dried by leaving the flask for an hour in the air bath at 212 to 221 deg. F., and the flask and contents weighed. The flask is then replaced in the air bath for half an hour and reweighed, to make certain that all moisture has been driven off.

The unsaponifiable matter is calculated as a percentage of the weight of rosin originally taken. This ingredient of rosin is apt at times to prove a source of trouble to the papermaker. In instances it separates from the cooling size in crusts, which form on the sides of the vessel. These crusts readily crumble and become detached, eventually finding their way into the paper and giving rise to rosin spots. Having determined the mineral impurities and unsaponifiable matter, what remains may be regarded as consisting of pure rosin. From this the amount of alkali required to convert the rosin to rosin size may be calculated. The combining weight of rosin is 346, so that every 100 pounds of

$$\begin{array}{l} \text{pure rosin requires } \frac{31}{346} \times \frac{500}{8.96} \text{ parts of} \\ \text{alkali, reckoned as sodium oxide (Na}_2\text{O),} \\ \frac{53}{346} \times \frac{100}{50.32} \text{ parts of alkali = sodium} \\ \text{carbonate (Na}_2\text{CO}_3\text{).} \end{array}$$

The amount of pure rosin (abietic acid) in a sample may also be determined by titration with acid. Ten grammes of rosin are dissolved in alcohol and a few drops of phenolphthalein solution added; decinormal caustic soda is then run in until a permanent red color is produced. One c.c. decinormal alkali is equivalent to .346 gramme pure rosin. The alcohol used should first be tested to see that it is of neutral reaction. This test is also a check on the purity of the rosin, as the larger the

percentage of abietic acid the more caustic soda is required to neutralize it. If, instead of neutralizing an alcoholic solution of rosin with caustic alkali, a weighed quantity of rosin be boiled with an excess of aqueous alkaline, neutralization of abietic acid with the formation of the sodium salt will also take place; but, in addition, the alkali will attack other substances present in small quantities in commercial rosin, with the result that altogether more alkali will be required than for neutralization alone.

The operation of boiling rosin with an alkaline liquor, known technically as a saponification process, resembles the actual process used in the manufacture of rosin size. The process is therefore carried out on a small scale to determine what percentage of the commercial rosin is capable of reacting with alkalis to form rosin soap or size. Five grammes of powdered rosin are generally boiled in a large porcelain dish, covered with a quarter glass with exactly 25 c.c. normal caustic soda for an hour or so. The contents of the dish are then taken out with about 50 c.c. neutralized methylated spirit, a few drops of methylorange added to the liquid N, and hydrochloric acid run in from the burette until the liquid turns red. The number of c.c. s of acid required is subtracted from 25 and gives the number of c.c. s of normal alkali required to saponify the 5 grammes of rosin and convert it completely into size. If the liquids are rather darkly colored it is a good plan when titrating to pour off a small quantity into a test tube, and to add to this a drop or two more methylorange; a red color developing is then easily seen.

The percentage of unsaponified matter in the rosin, reckoned as an abietic acid, may be calculated by multiplying the number of c.c. s of normal alkali required to saponify 10 grammes of rosin at 34.6. The figure so obtained generally averages about 10 per cent. more than that obtained by neutralizing an alcoholic solution with caustic alkali.

Of course, in the actual manufacture of size, less alkali is usually taken than is necessary to saponify the whole of the rosin, in order to leave some of the latter in a free state. Sodium carbonate is generally used in the place of the caustic soda in the above tests. The action, however, does not proceed so rapidly and requires more boiling and heating. Some of the darker grades of rosin yield just as good size as the better qualities, the only drawback being the darker color of the size prepared for them. The color is, however, largely separated in the liquor, which comes to the surface on cooling and can be skimmed off.  
—Paper.



#### DEATH OF JAMES DAVY.

We regret to announce the death of James Davy, the veteran Thorold pulp manufacturer, which took place at Niagara Falls, N.Y., on the 18th ult., as the indirect result of an operation some months ago, from which he never fully recovered. He was born in Kingston, Ont., 79 years ago. He acquired the pulp mill in Thorold about 25 years ago, and after putting its methods on a new and more up-to-date basis, turned it into a very profitable proposition. Mr. Davy was interested in all the movements making for the welfare of his district, and was very popular, especially with his employees. At the funeral, which took place from the family home in Niagara Falls, N.Y., there were many beautiful floral emblems from these and business associates.



—The Aktiebolaget Ethyl, Falun, Sweden, has sold the Canadian rights to its sulphite alcohol manufacturing process for \$25,000 cash and 25 per cent. of the resulting net profit. The process makes it possible to produce about eighteen gallons of alcohol per ton of sulphite.

## PEAT IN PAPER MAKING.

By Robt. J. Marx, of J. Marx & Co., London, England.

Ever since wood pulp has come to be largely used for paper making purposes, not a year has passed without an attempt to utilize the world's enormous resources of peat for the paper making industry. We have even heard of peat being bleached to make white paper!

Brown paper made from peat has been reported an accomplished fact many times, and numerous board mills—producing the material exclusively from peat—have frequently been reported as established in many countries.

To the writer's knowledge, a good many of these mills have been established, all with the same dire result of quickly disappearing, falsifying many hopes, and representing the waste of enormous sums and absorbing the energy and many of the best years of hard workers, all giving up the use of peat as the chief raw material.

It must be admitted that peat is, in its appearance, very misleading, not only to the eye of the layman, but also to the eye of the expert.

A cursory examination leads one to think that peat is a substance which contains a large amount of fibre, already in the state of slush, and which only requires just an additional touch to felt the fibres together, and to produce a serviceable sheet of paper, or board.

On many occasions statistical tables have been published of the world's great resources of peat, calculated to be able to supply the requirements of the paper maker for many generations.

The many failures have not, so far, scared off new schemes, which still crop up periodically.

No doubt peat can be made serviceable for many purposes, and one day it will assuredly play a considerable role in our industries, but although it is proverbially unwise to play the prophet, it may be safely asserted that peat, by

itself, will never make a useable sheet of paper or board for general consumption, and fulfilling the average requirements looked for in paper or board.

This article is not intended by any means to deal exhaustively with the subject, so that it will suffice to mention only a few of the difficulties which will always stand in the way of using peat to a large extent in the paper making industry.

The collective name of peat comprises a great variety of vegetable matter, all of which is more or less fibrous, some of greater strength than others, but none capable of standing any appreciable strain.

The decomposition which has been going on during centuries has weakened the material to such an extent, that its fibrous nature remains only in its superficial appearance.

It must be remembered, that peat usually occurs waterlogged, and in a mixture on the average represented by 92%—96% of water mixed with 8%—4% of solid matter, and even these 4%—8% solid matter do not consist of fibres alone, but contain a large admixture of non-fibrous materials.

We may, therefore, say that 100 tons of bog land, which have been handled, will yield at the best 8 tons of solid matter, and that these 8 tons of solid matter contain, at the most, about 2 tons of peat fibre.

Even if a successful method were discovered to employ these 2 tons of so-called fibre for paper making purposes, it is evident that the loss during the process would be enormous, so as not to yield more than 1 ton of paper or board.

It will be seen from the above that cutting, transporting, and stacking operations are required for a weight of 100 tons to secure 1 ton of peat paper, whenever a method which makes its production possible has been found. This hand-

ling of 99 tons of waste is already a serious charge even on the assumption that most of it can be done by suitable machinery.

The expense in connection with this, however, is insignificant when compared to the expense of evaporating-92 tons of water in order to get at this 1 ton of fibre.

In saying that 92 tons of water have to be evaporated for this purpose, the large additional quantity of water necessary to cleanse the fibre is entirely left out of consideration. When we assume it at the low figure of 8 tons, for the sake of this article, it will be seen that to obtain 1 ton of paper necessitates the evaporation of 100 tons of water, a work for which the energy of about 150 tons of steam, or its equivalent, is required.

This problem is made still more difficult by the hygroscopic nature of peat, which parts with its moisture reluctantly, so that even the best mechanical appliances which have so far been devised, have not been able to reduce the moisture from about 92% to 96% to less than about 65%, although the apparatus—all more or less on the lines of pressing devices, have been very ingeniously constructed and many of them have been very powerful machines indeed.

On account of its high cost, artificial evaporation has to be avoided as much as possible, and consequently it has been customary to stack the peat, and to allow it to dry to some extent under the influence of the wind and the sun.

In a country like Canada this must, of necessity, lead to complications, for peat can only be cut while there is no frost, say at the best during 8 months of the year, but the time during which natural evaporation goes on, on an extended scale, is even shorter, as for this in reality only the summer months play an important part.

It, therefore, seems that if operations are to be continuous all the year round, peat would have to be stacked under

cover in large quantities, and artificial evaporation employed on an extensive scale.

A large number of patents, taken out at various times and in many countries, for the preparation of peat for paper making purposes, have come under the writer's personal notice, and in this way he has become familiar with most of the chemical treatments proposed, and most of the mechanical appliances specially constructed, to treat the fibre as gently as possible, and to preserve its entire strength.

With none of these processes has it been possible to produce either a sheet of serviceable paper or board.

Many samples have been submitted of paper, which it was claimed contained from 80% to 100% of peat, but on analysis it was found, in most cases, that the actual quantity of peat contained therein was about 30% to 40%, and even then the paper was of insufficient strength.

The only successful employment of peat, to the writer's knowledge, is in paper or board mills where a small quantity of about 5 per cent. is added as a coloring agent and partly as a filler.

These very general outlines will show that, so far, peat on a large scale has not been successfully employed for paper making, and they will also show that it is very unlikely, if not entirely impossible, to be ever employed in this way, however useful it may be for other purposes, such as fuel, litter, a generator of power, and to recover valuable by-products.



J. F. Whitson, president of the Ontario Land Surveyors' Association, speaking recently of the great possibilities in the Northern Ontario clay belt, said: "If we could only succeed in inducing a few pulp mills to commence operations in that section, so as to give the settlers a market for the spruce on their lots, instead of having to burn it, we would soon settle up New Ontario."

# THE DEGRADATION OF MECHANICAL WOOD PULP DURING STORAGE.

By Fred Barnes, Shawinigan Falls, Que.

(Special to Pulp and Paper Magazine.)

In a previous article the present writer gave some account of various types of fungi he had noticed growing on wood pulp, and it was observed that the larger types of fungus, principally of more or less rapid growth, had no very profound effect on the pulp; on the other hand it was pointed out that a species of microscopic fungus was apparently chiefly responsible for the decay of most of the samples of wood pulp examined.

This article proposes to deal principally with the examination of the decayed wood itself. As mentioned in a

finally, as could be observed from the warmth of the pulp on opening the stacks and bales.

From the advanced rotten condition of the pulp it was not possible to say whether micro-fungi were responsible for the decay in the first place, as the microscope showed no trace of mycelia of fungus. It is probable, however, that such was the case, and the secondary reactions, including heating up of the pulp, took place and destroyed the fungoid growth itself. That bacterial action took place in the pulp to any great extent seems hardly probable, due

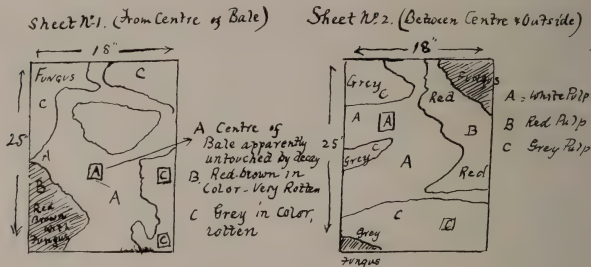

previous article, the discovery, on being opened up, that several stacks of mechanical wood pulp were badly damaged by rot, led the writer to investigate the matter. The mill was situated in the south of England; the pulp had been in stack for a considerable period of time, exposed to the weather.

The entire interiors of the various stacks were found to be almost ruined from the papermaking point of view. Examination of the stacks and opened-up bales clearly showed that more than one action had gone on within the pulp, a large amount of heat being evolved

to the strongly acid character of the final product of decay.

The appearance of the bales of pulp was very diversified, parts of the pulp being almost black in color, others red, but the main bulk was of a greyish color and at a maximum degree of rottenness. A large quantity of black fungus was growing on the rotten pulp in various parts, but this growth was apparently an after effect, the fungi finding a good feeding ground on the decayed pulp.

Microscopic examination of the pulp in its most rotten form showed that the



fibrous structure of the pulp had been entirely destroyed, only a mass of formless waxy looking particles remaining. The degraded pulp resembles the product of the disintegrating action of mineral acids on wood pulp.

It is interesting to point out at this stage, that jute, an analagous substance to wood, when baled in the moist state will sometimes undergo similar changes to the above.

Messrs. Cross & Bevan, of London, have investigated a case for the British Indian Government, which they refer to as "Heart damage in baled jute." The experimental results and conclusions drawn were strikingly similar to those obtained by the writer in the case of rotten wood pulp and a comparison of the two may be advantageous.

A bale of the wood pulp in an advanced state of decay was selected from a rotten stack, opened up and two sheets selected showing strong discoloration which are sketched below.

Sheet No. 1, although showing discoloration almost equal to Sheet No. 2, showed on testing with a knife that it was by no means so rotten as the latter.

The sheets were examined as follows:

- (1) Microscopical examination.
- (2) Yield of furfural.
- (3) Extraction by water for soluble bodies.
- (4) Examination of extractive bodies.

The sheets presented a very diversified appearance as shown in the sketches. The grey portions extended with uniform rottenness right through the sheets which were about one-eighth inch in thickness. The reddish coloration was chiefly confined to the immediate surface of the sheets, averaging perhaps one-twentieth inch in thickness; it was developed chiefly on the outside edges of the sheets, that is, where it had been more or less in contact with the atmosphere.

Microscopic Examination:

Sheet No. 1.—A. White pulp. Fibres in good condition. Appearance of average sample of pulp.

B. Red-brown pulp. Only partially broken down. Consists of large quantities of shapeless yellow particles, with a considerable quantity of short fibres, principally in bundles.

C. Grey pulp. Broken down to a nearly uniform mass of very small pieces of fibre.

Sheet No. 2.—B. Red-brown pulp. Broken down to a mass of structureless, reddish-yellow waxy-looking particles, with here and there a small bit of fibre. This shows a distinct trace of former fibrous structure.

C. Grey pulp. Broken down to a mass of structureless, waxy-looking particles. Hardly a trace of former fibrous structure left.

Yield of furfural— $C_4H_5O.COH$ .

This body, which is yielded on the hydrolytic distillation of pentosan containing bodies with 12 per cent. hydrochloric acid, is an important constant of various fibre substances, such as wood, esparto, straw, jute, etc., and is a measure of certain oxidised bodies other than cellulose present in the particular substance examined; that is to say, the pentosans.

The resulting furfural aldehyde is converted into hydrazone and weighed; then a simple calculation gives the quantity of pentosans present in the body examined.

Samples were taken from the sheets as indicated in the diagrams, dried, and the furfural yield determined.

	Percent'ge of furfural.	Percent'ge of pentosans.
Sheet No. 1.		
A. Undecayed pulp..	4.39	8.97
B. Red-brown pulp..	3.48	7.10
C. Grey pulp .....	3.38	6.93
Sheet No. 2		
A. Undecayed pulp..	4.51	9.20
B. Red-brown pulp..	2.51	5.14
C. Grey pulp .....	2.12	4.35

The red-brown pulp in Sheet No. 2 was picked out from various parts of

the bale where it was most decayed. The grey pulp in this sheet was apparently at its maximum degree of rottenness.

Samples were next extracted with hot water.

	A. White pulp.	B. Red pulp.
Loss in weight %..	1.8	20.3
Weighed extracted matter % .....	...	15.35
Loss in weight % ..	...	18.1
Weighed extracted matter % .....	...	15.7

Further trouble was caused at the mill during 1908 by the arrival of pulp direct from Scandinavia in a badly rotted condition; however, in these cases anything in the nature of black fungus or mould was not observed, the rotten pulp being brownish-grey in color and extremely friable. The ends and outside edges of the bales were chiefly affected.

A representative bale, manufactured in June of the previous year, was taken. This bale, among others, had been under storage in the mill in Southern Norway, and shipped to England in February, 1908. Only about seven months had elapsed since the manufacture, yet about 15 per cent. of the bale was utterly ruined. This bale was rotted from one end inwards, the other end being quite free from decay.

In one case samples were taken from the bale and the furfural determined without drying the pulp, the moisture being separately estimated. In the other case samples were dried from two weeks at 96°-97° C. to ascertain effect of oxidation, if any.

Bale No. 2.—Furfural yield:—

	% Fur-fural.	% Pen-tosans.
* White undecayed pulp	4.32	8.86
* Grey decayed pulp. .	3.35	6.86
† White undecayed pulp	4.50	9.20
† Grey decayed pulp..	3.32	6.80

\* Undried pulp.

† Dried pulp.

It is evident from these figures that prolonged heating has little, if any, effect on the pulp.

Bale No. 2.—Extraction by hot water. One sample of grey pulp dried, the other

C. Grey pulp.	
14.0	Pulp was extracted in the moist condition, the water being estimated separately.
12.5	
10.7	Before extraction the pulp was dried in a steam oven.
8.85	

extracted in the moist state, the water being separately determined.

	Moist sample.	Dried sample.
Loss in weight %.	24.6	22.85
Weighed extracted matter % .....	19.8	19.0

Microscopic examination—Bale No. 2.

The rotten grey pulp consisted mainly of a mass of small bits of fibre with sharp fractures, plus a quantity of fairly long fibres, showing that rotting had not reached its maximum in this case.

Furfural yield of rotten pulp before and after extraction by hot water:—

	% Fur-fural.	% Pen-tosans.
Before extraction with water .....	3.86	7.90
After extraction with water .....	2.90	5.93

#### Examination of Extracted Matters.

The water extract was dark brown in color, and when in a hot, concentrated condition had very much the appearance and smell of logwood extract. On evaporation to dryness at 100° C. a certain amount of apparent charring took place, with a caramel-like smell. The extract was strongly acid in reaction, and reduced Fehling's solution strongly.

Four estimations for furfural yield in the dry extract gave:—

Furfural .....	= 4.44 %
Pentosans .....	= 9.07 %
Or, calculated to dry pulp,	
Furfural .....	= 0.66 %
Pentosans .....	= 1.35 %

If the extract had been practically entirely a pentose sugar, a yield of about 64 % of furfural would have been obtained, consequently the extract must be mainly composed of other bodies.

The reducing power of the extract on Fehling's copper solution, expressed in terms of glucose, = 36.2 %, this being equivalent to 5.38 % on the dry degraded wood.

The extract gave an osazone with phenyl-hydrazine in the cold, this reaction implying a 1 derivative, and  $\text{—CO}$  comes from the lignone groups. The extract also reacts strongly with chlorine with the formation of the characteristic yellow quinone chloride.

The low furfural yield from the grey pulp of Sheet No. 2 shows that the degradation has proceeded to a maxi-

mum in this case, the pentosans having been reduced to less than half their original content, indicating a great chemical change in the pulp.

The higher yield of furfural by the red pulp, coupled with the fact that the redness is found mostly on the surface and edges of sheets, points to the influence of atmospheric oxygen. The furfural yields of the white portions of the pulp are in agreement with what other observers have found for coniferous woods untouched by decay.

The large quantities of water-soluble bodies in the decayed pulp, varying from 14—24 % as compared with a normal quantity of 2 %, again shows the profound nature of the chemical change in the pulp.

The small yield of furfural given by the dry extract on the one hand and the heavy reduction of Fehling's solution on the other shows that the extract consists mainly of bodies of low molecular weight and very readily oxidisable.

Comparing Cross & Bevan's results for damaged jute, a considerable similarity is noted:—

	Jute.		Woodpulp.	
	(Cross & Bevan.)		Damaged	Damaged
	Sound fibres.	Damaged fibres.	fibres.	fibres.
Constituents soluble in water...	1.1	11.5	1.8	14-24½ %
Furfural yield .....	7.8	5.8	4.43	2.12 %
Pentosans .....	15.8	11.8	9.08	4.35 %
Phloroglucinol absorption ....	4.2	8.0	.....	.... %
Chlorination reaction (H C E formed) .....	8.0	10.2	Strong absorption of chlorine	Considerably stronger absorption of chlorine

The aqueous extract reduces Fehling's solution strongly.

Extract reduces Fehling's solution strongly.

Gives an osazone with phenyl-hydrazine.

Gives an osazone with phenyl-hydrazine.

Cross & Bevan observe that: "In its extreme form heart damage in jute results in the total disintegration of the fibre, which breaks down under slight pressure to fine dust. No penetration of the tissues by the mycelia of fungus was observed; the fractures were sharp, and there was no tendency to resolution of the bundles into their ultimate fibres."

They describe "heart damage" as "A profound hydrolytic degradation of the lignocellulose complex as a whole. The changes take place in both lignone and cellulose components simultaneously and equally, no selective separation of either component being observed. The phloroglucinol reaction and the osazone formation point to the opening up of carbonyl groups in the lignone residue as the result of hydrolysis, while the cellulose portion of the molecule is partly converted into soluble carbohydrates. The decrease in the furfural constant may indicate attendant deoxidising conditions."

Further, Cross & Bevan found that, after prolonged incubation of sound bales containing excess moisture, moulds and other aerobic growths developed on the samples superficially, and ultimately attacked the fibre, but this attack bore no resemblance to the very profound and specific form of damage investigated.

These observations on rotten jute agree almost exactly with the present writer's observations of rotten wood-pulp.

Looking over the figures, it will be noted that the furfural yield of the grey pulp in Sheet No. 1 and in Bale No. 2 are about equal, and both show the same appearance under the microscope, namely, tiny pieces of fibre sharply fractured. In Sheet No. 2 the fibrous structure has quite disappeared, accompanied by a fall in the furfural yield by about 40%.

It is probable that all of the bales of rotten pulp were made from wood cut in the spring or early summer, as it is

well known that the sap then contains sugars which are well adapted for feeding fungi, moulds, etc.

It is plainly inadvisable to keep bales of ground woodpulp for any great length of time closely stacked together exposed to the weather, as light and air are cut off from the interior bales, and then the conditions seem to be ideal for a rapid propagation of certain kinds of fungi and other organisms, such as bacteria, etc. This applies more forcibly to those countries with a moist climate, where alternations of rain and sunshine occur frequently.

In stacking pulp, all bales showing any rot or mould growths should be put on one side and kept strictly apart from the normal bales. As much air and light as possible should be allowed to play around the bales, as under such conditions the pulp would largely lose its moisture and systematic degradation would slow down and cease.



—The United States Forest Service, Washington, has issued as one of its Forest Products Laboratory series, a small book entitled, "Paper Pulps from Various Forest Woods," with experimental data and specimens of soda and sulphite pulps, compiled by Henry E. Surface, Chemical Engineer in Forest Products. The samples, of which the greater part of the book consists, will indicate the possibilities of pulp for certain woods, of which some have been used commercially to a slight extent, and others not used at all. Final conclusions would be rash at this stage, but there is no doubt that some of these comparatively unused woods might be taken advantage of by paper manufacturers.



Laurentide Paper Co. made further sensational rises in the price of its stock. It is now 175 on Montreal Stock Exchange or equal to 350 on the old basis.

# PULP WOOD CONSUMPTION IN CANADA, 1910.

The following figures, given for pulpwood consumption, compiled by H. R. Macmillan, B.S.A., M.F., of the Forestry Branch of the Department of the Interior, refer only to wood manufactured into pulp in Canadian mills, and include only wood of domestic origin.

The fifty-one mills reporting used, in 1910, 598,487 cords of wood. There were exported in a raw state 943,141 cords, and for the first time pulpwood was imported into Canada to the extent of \$49,322.

Over 95 per cent. of Canadian mills cut the pulpwood used by them from their own limits, and consequently Ross the wood themselves.

Although 23,642 cords of wood, or 3.8 per cent. less was used in 1910 than the year previous, the average price per cord has increased the value of the pulpwood industry by \$121,074 over its value in 1909. The decrease in the quantity is due to temporary closing of one or two large mills. This year the price of pulpwood recovered from the decline seen in 1909, when the price was only \$5.57 per cord, and is about the same as in the year previous. The price was \$6.07 in 1908 and in 1910 was \$6. In 1910, also, 29,196 more tons of pulp were produced than during 1909, owing to an increase this year of some 145 lbs. in the amount of pulp produced per cord of wood.

Quebec is the premier pulpwood province of Canada because of its extensive spruce and balsam fir forests suitable for pulpwood, abundant and cheap water-power and plentiful supply of labor. The twenty-five mills in Quebec reported the consumption of 57 per cent. of the total for Canada, or 22,820 cords more than in 1909. Ontario likewise increased the amount consumed in its fifteen pulp mills by 23,200 cords, and used over one-third of the total consump-

**Table I.**

Province.	1909.				1910.			
	Wood used. Cords.	Value. \$	Average value per cord. \$ c.	Pulp Produced (1) Tons.	Wood used. Cords.	Value. \$	Average value per cord. \$ c.	Pulp Produced (1) Tons.
Canada	622,129	3,464,080	5 57	445,408	598,487	3,585,154	6 00	474,604
Quebec	319,935	1,866,700	5 83	238,286	342,755	1,879,831	5 48	282,938
Ontario	187,352	1,070,740	5 72	132,491	210,552	1,479,538	7 02	156,076
Nova Scotia	25,076	101,945	4 07	23,396	29,606	135,965	4 59	25,955
New Brunswick	88,450	414,689	4 69	49,991	15,134	87,620	5 79	9,285
British Columbia	1,316	10,006	7 44	644	440	2,200	5 00	350

<sup>1</sup> Approximate.



tion. The two provinces just named furnished over 92 per cent. of the total quantity of pulp. Nova Scotia consumed nearly 20 per cent. more than last year, while New Brunswick used barely one-fifth as much as in 1909.

The decrease in the amount of pulpwood used in 1910 chiefly affected the use of spruce—45,800 cords less of this species being used in 1910 than in 1909.

Although still over 75 per cent. of the total pulpwood consumption, the proportion is gradually becoming less. In 1908 spruce formed 87 per cent. of the total, in 1909, 83 per cent., and in 1910 78.6 per cent.

Balsam fir is a wood which is increasing in importance as a pulp-wood. In 1910, 20 per cent., or 20,380 cords more balsam fir was used than in 1909.

Table 2.

Pulpwood 1909 and 1910, by Species: Total Quantity, Total Value and Per Cent. Distribution.

Kind of Wood	1909		1910	
	Quantity Cords	Value	Quantity Cords	Value
Total .....	622,129	\$3,464,080	598,487	\$3,360,154
Spruce .....	516,030	2,793,318	470,230	2,866,678
Balsam .....	100,095	637,065	120,475	698,608
Hemlock .....	700	3,156	3,810	16,922
Poplar .....	5,188	30,135	3,608	21,366

Table 3.

Pulpwood, 1910, by Provinces, Species and Processes: Quantity of Wood Used.

**Total—All Processes.**

Provinces	Total Cords	Spruce Cords	Balsam		Unspeci-	
			Fir Cords	Hemlock Cords	Poplar Cords	fied Cords
Canada .....	598,487	470,230	120,475	3,816	3,608	358
Quebec .....	342,755	239,824	96,474	3,616	2,483	358
Ontario .....	210,552	189,196	20,256	.....	1,100	...
New Brunswick .....	15,134	15,134	.....	.....	.....	.....
Nova Scotia .....	29,606	25,636	3,745	200	25	.....
British Columbia .....	440	440	.....	.....	.....	.....

**Mechanical Processes.**

Canada .....	388,561	323,350	64,377	600	25	209
Quebec .....	243,362	188,905	53,848	400	.....	209
Ontario .....	115,593	108,809	6,784	.....	.....	.....
Nova Scotia .....	29,606	25,636	3,745	200	25	.....

**Suphite Process.**

Provinces	Total	Spruce	Balsam		Unspeci-	
			Fir	Hemlock	Poplar	fied
Canada .....	192,857	134,959	56,098	.....	1,800	.....
Ontario .....	93,859	80,387	13,472	.....	.....	.....
Quebec .....	86,424	41,998	42,626	.....	1,800	.....
New Brunswick .....	12,134	12,134	.....	.....	.....	.....
British Columbia .....	440	440	.....	.....	.....	.....

**Soda Process.**

Canada .....	17,069	11,921	.....	3,216	1,783	149
Quebec .....	12,969	8,921	.....	3,216	683	149
New Brunswick .....	3,000	3,000	.....	.....	.....	.....
Ontario .....	1,100	.....	.....	.....	1,100	.....

In 1908 it formed 12 per cent. of the total, in 1909, 16 per cent., and in 1910, 20 per cent. of hemlock, over five times as much as was used in 1910 as during 1909. Hemlock was reported as a pulp-wood for the first time in 1909, and this year it was used to a greater extent than poplar, thus becoming the third species in importance.

Nearly four-fifths, namely, 78 per cent. of the pulpwood manufactured in Canada in 1910 was manufactured by the mechanical process; the sulphite process produced one-fifth and the remainder (2 per cent.) was manufactured by the soda process. Quebec made 63 per cent. of the total mechanical pulp in Canada—more than twice as much as did Ontario. Of sulphite pulp, Ontario produced the most, although Quebec was a close second. The latter province manufactured over three-quarters of the pulp made by the soda process.

Spruce, as in former years, was the chief wood used in each process. Over two-thirds (68.8 per cent.) was used for mechanical pulp; over one-quarter (28.7 per cent.) was made into sulphite pulp, and the remaining 2.5 per cent. was manufactured by the soda process.

Balsam fir has not yet been used in the soda process and is used to almost the same extent as the two other processes. The mechanical process consumed some 53 per cent. of this wood, while 47 per cent. was manufactured by the sulphite process. Eighty-four per cent. of the hemlock was manufactured by the soda process, which is adapted for most species of wood. One-sixth of the hemlock was used to make mechanical pulp.

#### **Mechanical Process.**

Pulp manufactured by the mechanical process forms a greater percentage of the total during 1910 than at any time in the past. In the United States the percentage of ground pulp used is decreasing. The cause of the increase this year in Canada is probably due to the interruption of manufacture by the sulphite mills of New Brunswick. Unlimited supply of clean water is a

necessity in the manufacture of wood by the mechanical process. A species of wood is also required which has a long loose fibre, which will not lose its shape and texture in the grinding. For these reasons Quebec with its spruce and balsam fir tracts and numberless waterfalls, is the province best adapted for mechanical pulp manufacture.

Spruce furnished 83.2 per cent. of the wood used for mechanical pulp, and balsam fir contributed 16.6 per cent., with small quantities of hemlock and poplar making up the balance.

The average cord of wood reduced by the mechanical process in Canada during 1910 produced 1,908 pounds of pulp. This is 257 pounds more per cord than was produced last year, but such comparisons depend greatly on the relative condition of air-dryness of pulp. Slightly over half this amount of pulp is produced per cord of wood by either the sulphite or soda processes, but the quality of texture is much better. The paper used in the average newspaper of to-day is composed of about twenty-five per cent. of sulphite fibre and seventy-five per cent. of the ground-wood fibre made by the mechanical process.

#### **Sulphite Process.**

In British Columbia, experiments are being carried on with the sulphite process, and, in 1910, 440 cords of spruce were used in the manufacture of paper.

Seventy per cent. of the wood used in the sulphite process was spruce, mostly from Ontario. Balsam fir furnished 29 per cent., about three quarters of which was from Quebec, and the same province used 1,800 cords of poplar to make sulphite pulp.

The average production of pulp for every cord of wood used in the sulphite process during 1910 was 997 pounds.

#### **Soda Process.**

Canada has the distinction of having the oldest soda mill in America, although the process is, at present, not in general

use, and is found in only a few small mills. The production by this process, however, will shortly be increased by the completion of a large new mill, for the manufacture of Kraft paper from soda pulp.

The soda process was the principal method used in the reduction of hemlock. Small quantities of spruce and poplar were also used in 1910. Balsam fir, however, is not suited to this process. Of the total, spruce formed 71 per cent.; hemlock, 19 per cent., and poplar, 10 per cent.

The annual consumption of pulpwood per mill in Canada, during 1910, was 11,735 cords, as compared with a consumption of 12,442 cords per mill in 1909. The largest mills are those in Ontario, which used an average of 14,037 cords per mill. The average consumption per mill in Quebec was 13,710 cords; in Nova Scotia, 4,934 cords, and in New Brunswick, 3,783 cords.

#### Exports.

Canada's foreign trade in pulpwood and wood-pulp is growing greater. Unfortunately, the tendency is still to export wood in the raw form of pulpwood rather than in the manufactured form of wood-pulp. This is a direct loss to the country, for the increased value due to manufacture is given away. The data in the following tables refer to the calendar years, and have been furnished by the Department of Trade and Commerce.

In 1910, for the first time, \$49,000 worth of pulp was imported into Canada, four-fifths of which was from the United States.

(To be Continued)

\* \* \*

A movement is on foot among United States paper manufacturers, including A. C. Hastings, president of the American Paper and Pulp Association, to explore Labrador thoroughly for its pulpwood possibilities.

#### NEW INCORPORATIONS.

South Shore Power and Paper Co., Limited, Montreal; capital, \$2,000,000. To carry on a lumber and pulpwood business, develop water-powers, etc. R. Chenevert, H. L. Mitchell and P. Gregory, of Montreal.

Forest Reserve Pulp and Paper Co., Limited, Montreal; capital, \$1,000,000. To manufacture and deal in lumber, pulpwood, pulp, paper, peat, wood alcohol, etc. G. W. MacDougall, K.C., and J. G. Cartwright, accountant, of Montreal.

E. M. Wilcox, Limited, Toronto; capital, \$60,000. To do business as printers, publishers, newspaper and magazine proprietors, stationers, etc. K. G. Beaton and G. G. McGarry, Toronto.

Bulgarian National Printing House, Limited, Toronto. To publish papers, magazines, etc. J. Theophilact and G. Stoyanoff, Toronto.

The Morrey Publishing Co., Limited, Ingersoll, Ont.; capital, \$40,000. To take over the interest of J. F. Morrey in the Union Publishing Co. and carry on the business of E. B. Morrey and a general printing and publishing business.

The Ontario Paper Co., Ltd., Toronto. Capital, \$10,000. To manufacture, import and export paper and paper materials, wood pulp, etc. S. G. Shepard, S. E. Thomason, Perry S. Patterson, and F. A. Dean, Jr., Chicago, and H. C. Lufkin, Evanston, Ill.



The New Brunswick Pulp and Paper Co., Millerton, N.B., now have in operation their new machine for making machine-glazed Kraft paper. A considerable quantity of other equipment has also been put in, including triple-set Swenson evaporators and causticising plant, a rotary digester, etc.

## TRADE AND MANUFACTURERS' NOTES

---

The Scandinavian-American Trading Co., New York, referring to the clause in the United States tariff giving free entry of pulp and paper from Canada to United States, have sent out a circular under date of March 4th as follows:—

The United States Government has now finally officially refused to grant those nations enjoying in their relations with the United States the "most favored nation" clause the privilege of free entry of pulp and paper, which privilege is enjoyed by Canada.

The matter is now going to be decided in court. It is, therefore, of utmost importance that such records should be kept by the cellulose makers in Europe that we will have evidence as to the origin of your shipments that will satisfy the American court. We, therefore, request:—

1. That you make, and carefully keep in your possession, records showing as completely as possible the origin of the wood used in each individual shipment of cellulose that you are making us. Please note to keep such records of each individual shipment, and have such records convenient, so that if needed in court a little later we can have access to the same.

2: If possible, give explicitly and concisely in the consular invoice information as to where the wood comes from used in such shipments that you are making us:—

- (a) Name of the place.
- (b) Name of the county.
- (c) Name of the province.

Such information will prevent the Government here from throwing out claims owing to being uncertain as to the origin of the wood used in the shipments.

3. Please also declare in the consular invoice that the cellulose is a product of your country (or whatever country it may be), and that its exportation is not

subject to any "export duty, export license fee, or other export charge of any kind whatsoever (whether in the form of additional charge or license fee or otherwise), or any prohibition or restriction in any way of the exportation (whether by law, order, regulation, contractual relations or otherwise, directly or indirectly)."

By refusing free entry to European cellulose the United States Government has shown its hand; i.e., will not grant the most favored nations what is coming to them. The Government is likely to take up any points in the defence of its attitude, and, therefore, this is written to try to eliminate a few.



### LYFORD, CLARK & LYFORD.

---

Lyford, Clark & Lyford, Forest Engineers, Montreal, have issued an interesting pamphlet on "Forest Surveys: What They Are, Wherein They Serve, and What They Cost." The results to be expected from a forest survey are summarized, among the chief items being a more reliable valuation of the property, more effective general plan of operation, best location of roads and other improvements, increased efficiency of fire protection, etc. Regarding the cost of forest-surveying in the pulpwood region of Eastern Canada and North-Eastern United States, where the stand is light and the value per square mile correspondingly low, it is stated that a complete survey may be made for \$30 to \$40 per square mile, which, while not absolutely accurate in details, is yet complete enough to permit the preparation of reliable contour maps on a scale of four inches to the mile.

A new firm of forest engineers has recently opened offices in Philadelphia under the name of Clark, Lyford & Sterling. The members are Judson F.

Clark, of Vancouver, B.C., C. A. Lyford, of Montreal, Que., and E. A. Sterling, of Philadelphia. Mr. Clark and Mr. Lyford are also identified with the well-known firm of Clark & Lyford, Vancouver, B.C., and Lyford, Clark & Lyford, Montreal, Que. Mr. Sterling has resigned his position as Forester of the Pennsylvania Railroad, which he has held for the past five years. This organization is making a specialty of timber estimates and forest maps, and is prepared to examine and report on timber properties anywhere.

The Smart-Turner Machine Company, Limited, Hamilton, have received an order for an independent jet condenser for the New Brunswick Pulp and Paper Company, of Millerton, N.B.; for a centrifugal pump from the Grenville Board and Pulp Company, of Thorold; for a duplex pot-valve pump from the Jonquiere Pulp Company, Jonquiere; for a centrifugal pump from the Big River Lumber Company, Big River, Sask.; for a single-acting triplex power pump from the Bird Woolen Mill Company, Limited, Bracebridge, Ont.; for a centrifugal pump for the Dryden Timber and Power Company, Dryden, Ont.

\* \* \*

"Kraft—The Gist of the Subject," is the title of a neat little booklet published by the Swenson Evaporator Co., Chicago, for consideration of Kraft manufacturers, present and prospective. Money has been lost by those desirous of installing Kraft manufacturing plants on this continent through their losing sight of the fact that through local causes peculiar to this country the methods which had proved successful in Europe could not be used in their entirety here. The Swenson Evaporator Co. explain the newer, more economical methods which have come into use during the last few years. The newer mills have largely adopted the principle of the multiple effect evaporator, which broadly speaking, is similar to that used in soda pulp mills, and in which the hot gases from the melting

and burning of the black ash are led through a properly designed waste-heat boiler from an outlet flue of the boiler, and pass through an open evaporator of the type used in Europe. The improvements which have been effected in this are described in the book, which may be had on application.

\* \* \*

The Sandy Hill Iron and Brass Works, Hudson Falls, N.Y., send us a catalogue describing Packer's new, open-side, sectional diaphragm pulp screens, built exclusively by this well-known firm. Its strong point is that any number of screens may be set in line, end to end, coupled together and driven from either end, and so arranged that any shaft may be uncoupled and removed from the screen sidewise easily and quickly when required. The diaphragms and working parts of these new open-side screens are practically the same as used in the firm's original Packer screens, of which there are over seven hundred now in use in the best mills in Canada, the United States, Japan, China, Scandinavia, etc., and none of which have ever been rejected for any cause whatsoever.

\* \* \*

—Canadian Facts Publishing Co., 667 Spadina Avenue, Toronto, have issued a new edition of "Five Thousand Facts about Canada." It would take 500,000 facts to do justice to the subject of the material resources of the country, but it should not be inferred from this that these half million facts are to be weighed in the balance with the half dozen ideals which are the real need of Canada to-day. While wealth accumulates men may decay, but happy shall we be as a nation if we apply our wealth and resources generously to the service of mankind. The price of the book remains as before, 25 cents per copy. If the publication had been delayed another month the outline map it contains might have shown the new boundaries of the provinces bordering on Hudson Bay.



## Recent Canadian Patents Granted on Pulp and Paper Machinery and Allied Inventions.

No. 135,993.—Machine for Reducing Wood to Pulp.—Jos. J. Roy, St. Basil, N.B. This is a jointed beater, able to turn vertically, with a circular saw mounted on same, operated by a wheel, which receives its movement from the axis which serves for the turning. There

travelling said bars to close them and cause adjacent edges of said gripped parts of the material to meet one of said series of bars having means for causing the material intervening between adjacent edges of said gripped parts and whereon no pressure is applied initially to become simultaneously folded, as the bars close, in the spaces separating adjacent bars of another

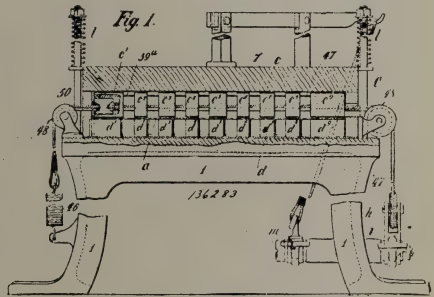
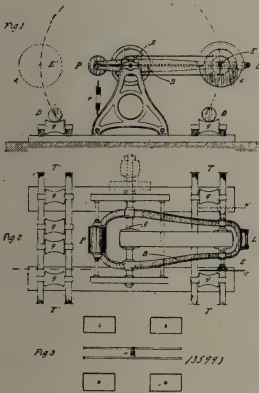

are also a counter-weight and an appliance to effect the automatic return of the saw.

No. 136,283.—Pleating Paper Apparatus.—C. R. Heiser, London, Eng. This is an apparatus for continuously producing sheets of pleated paper for packing and like purposes, comprising successive series of spaced bars adapted to co-act in succession with another series of spaced bars to simultaneously grip predetermined areas of successive lengths of the material between their mutually opposed faces, means for

series whereby the material is formed at one side with a series of spaced pleats or folds alternating with plane areas, means for locking together said adjacent bars, means for further travelling one series of bars, means to cause the application to the under side of each of said lengths of pleated material of an additional backing sheet whereby to hold said meeting adjacent edges to permanently retain the correct relative positions of the folds, and means for releasing said adjacent bars to permit the withdrawal from the machine of the pleated article.



The Scandinavian-American Trading Co., Produce Exchange Building, New York, has our thanks for a pretty calendar printed on a card made of aluminum.

Recently the Edward Partington Pulp and Paper Co., St. John, N.B., has been purchasing pulpwood from the Mispec Pulp Co., whose mill has been closed down.

### ARGENTINE PAPER REQUIREMENTS.

On behalf of enquirers into the newsprint paper needs of the Argentine Republic, we have obtained through the courtesy of the Trade and Commerce Department, Ottawa, the specifications laid down by leading Buenos Ayres newspapers in inviting tenders for stocks for the coming year. While other buyers perhaps have other needs, these specifications are given here as a possible guide of some value to the general needs of the market. We may add that samples may be obtained on application to the Department at Ottawa.

1. A stock of approximately 900 tons of paper should be maintained in this market, in order to provide against strikes or other unlooked for events that might occur either at the manufacturers' end, or at this, and as a reserve stock for a period of three months.

2. In the quantity mentioned in the preceding paragraph would be included bobbins of various sizes, and in the proportions which will be specified lower.

3. The measurements of the paper used in printing our newspapers correspond with the four stamped samples, numbered 1 to 4, said numbers corresponding in width to the number of pages. No. 1 is equivalent to 0.405 millimetres, No. 2 is equivalent to 0.794 millimetres, No. 3 to 1,200 millimetres,

450 bobbins of 62-inch, equivalent to	kilogrammes	238,500
160 " " 0.794 mm. " "	"	40,000
51 " " 1.200 mm. " "	"	20,000
6 " " 0.405 mm. " "	"	1,500

kilogs. 300,000.

and No. 4 to 52 inches. These measurements correspond exactly with the width of the samples forwarded, with which they should be compared.

4. The quality and weight of the paper is the same for Nos. 2, 3 and 4, whose weight is 52 grammes per square metre. Sample No. 1, corresponding

to paper one page wide, weighs 56 grammes per square metre.

These weights may be increased or diminished, always provided that the increased or diminished weight be compensated for in strength, quality and whiteness, conditions of the utmost importance to the object for which the paper is destined. Given the qualities mentioned preference would always be given to a lighter paper

5. All bobbins of whatever width, will have an approximate metrage of 6,000 metres, and the paper will be rolled on a strong tube of cardboard with an interior diameter of 3 inches

6. The bobbins must be numbered inside (on the tops) as near as possible to the centre, the numbering being repeated on the outside packing, very clearly, for purposes of revising and checking.

7. The packing should unite all possible conditions necessary to the proper preservation of the paper, special attention being paid to the edges and tops of the bobbins as being the most exposed parts, any injuries to which render the paper useless. This packing may be of cardboard, or preferably of wood, provided the additional cost be not too great.

8. The approximate monthly quantities which we could use would be 300 tons, and should be divided as follows:

9. Each bobbin will have two cylindrical wooden wedges, perforated, in each end, for the purpose of preventing the flattening of the cardboard tubes due to loading and unloading operations.

10. One page bobbins (sample No. 1) owing to its small bulk may be sent

joined in copules in the same packing, and each numbered inside and out, the lesser number being always the odd one, e.g. 31/32; 345/6.

11. Once the stock referred to in Clause No. 1 has arrived here, and in the proportions established by Clause No. 8, the approximate monthly shipments and proportions would be as follows:—

110/15 bobbins of .....	62	“
40 “ “ .....	0.794	mm.
12/13 “ “ .....	1,200	“
1 or 2 “ “ .....	0.405	“
—		
Total bobbins per ship- ment .....	163	

12. Conditions of payment, etc., will be such as may be arranged by both parties from the study of this estimate.

13. The annual quantity mentioned in Clause No. 1, and the corresponding monthly quantities mentioned in Clause 8, may be increased or reduced by one-half, and any contract which may be made may also be renewed.

14. In accordance with the terms of the preceding clause a price should be sent, as also the conditions, free of all expense in Buenos Ayres, for the total quantity mentioned in this estimate and for one-half the total quantity.

15. In view of the difficulties which might arise, due to the quality of the paper and the other conditions specified in this estimate, we should be glad to receive in the nature of a trial (when the present proposal has been duly studied) some bobbins of 62 “, this being the size presenting the greatest difficulties to our machines.

**Important.**—Amplifying the terms of Clause No. 7, the weight of the packing should be discounted, and, in order to facilitate the calculation of this, an approximate weight per bobbin for each measurement, either in cardboard or wood, may be stipulated.

—A very important hearing came up a few days ago before the Board of United States General Appraisers at the port of New York. Protests were made by the wood pulp and print paper importers of the United States, and the settlement involved the interpretation of old and new treaties existing between this and foreign countries. It was claimed by the importers that by reason of the “most favored nation” clause in the treaties with some of the nations, the products coming from Norway, Sweden, Germany and Russia are entitled to the same free entry that has been accorded to Canadian wood pulp since the passage of Section 2 of the reciprocity compact July 26 last. These protests are for a refund of duties paid since Section 2 became effective and many thousands of dollars in revenue are involved. After much wrangling the United States Government, upon the suggestion of the American Wood Pulp Importers’ Association, agreed to hear ten test cases and hold the others in abeyance until these cases were decided upon. The protests selected for the test case relate to importations from Austria, Norway, Sweden, Germany, England, Belgium and Russia. The matter is the culmination of a long series of protests by not only the importers, but by the nations which export pulp and paper into the country.



The Consolidated Pulp and Paper Co., St. John, N.B., which, as announced in last issue, will take over the Partington pulp mill and extend it, is under the management of N. M. Jones, formerly manager of the Katadin Pulp and Paper Co., Bangor, Me.

\* \* \*

Our interesting contemporary, “Paper,” has made such headway since it started, a year or so ago, that it has moved to larger premises, and is running its own printing and publishing plant. Its new offices are at 373 Fourth Avenue, New York.

## PULP AND PAPER NEWS.

---

Carl Moe is leaving the pulp mill at La Tuque and is going this month to the Wayagamack Pulp and Paper Co., Three Rivers.

\* \* \*

The case of Mann vs. the St. Croix Paper Co., of Halifax, N.S., is being argued before the Supreme Court of New Brunswick.

\* \* \*

R. G. Varey, manager of the Rior-don Paper Mills at Merriton, met with an accident while bobsleighbg, but is now almost recovered.

\* \* \*

The St. Lawrence Paper Co. have moved their Toronto offices from Wellington Street East to the Bell Telephone Building, Adelaide Street West.

\* \* \*

The Eastern Paper Co., at St. Basil, Que., have for the time stopped making felt papers and are running on building papers and board.

\* \* \*

We hear that the Wayagamack Pulp and Paper Co., Three Rivers, has closed contracts in Europe and Australia which will take its whole output for the next nine months.

\* \* \*

The St. Lawrence Pulp and Paper Co., now manufactures board from waste papers from the Dominion Government offices, Ottawa. There are large quantities of this material available.

\* \* \*

The Bathurst, N.B., Lumber Co. has taken over the limits of the Nepisiquit Lumber Co., and, we understand, will shortly begin work on the construction of a pulp and paper mill.

\* \* \*

C. V. Syrett, manager of the Victoria Paper and Twine Co., Toronto, agents for the Continental Paper Bag Co., of Ottawa and other concerns, is convalescing from a serious illness.

Montreal capitalists, including Sir Rodolphe Forget, have bought the Lotbiniere and Megantic Railway, running through valuable pulpwood areas in the eastern townships. Their intention is said to be to extend it.

\* \* \*

The by-law granting a fixed assessment to James Battle, trustee for the company that intends erecting a large paper and pulp mill, with a capital of one million dollars, on the new Welland Canal at Thorold, was carried by a large majority. The site consists of some twenty-five acres immediately adjoining the town limits.

\* \* \*

Geo. Spence, vice-president of W. J. Gage & Co., paper dealers, manufacturing stationers, etc., Toronto, died last month. W. P. Gundy, of the Kinleith Paper Co., has been elected vice-president of the W. J. Gage Co., wholesale paper dealers and stationers, Toronto, replacing the former. Mr. H. H. Love becomes treasurer of the company.

\* \* \*

The Northern Islands Pulpwood Co., Limited, of Windsor and Port Arthur, Ont., has assigned for the benefit of its creditors to G. T. Clarkson, Toronto. A meeting of creditors will take place at his office on the 15th inst. for the purpose of receiving a statement of the company's affairs, appointing inspectors, etc. All claims should be made on or before April 6th next.

\* \* \*

It is again stated that the Bayless Pulp and Paper Co., whose mills at Austin, Pa., recently met with such an overwhelming disaster through the bursting of a dam, will erect mills at Beauré, Que., near which place they already own extensive tracts of timber land. Power will be supplied by the Stadacona Power Co. from Seven Falls, about thirty miles from Quebec.

The Standard Paper Co., which was incorporated some years ago with a capital of \$250,000, are opening offices at 8 Wellington Street East, Toronto, as wholesale dealers in boxboard, mill-board, wall board and plaster board, and will later on deal in wrapping papers.

\* \* \*

Commenting on a recent item in this journal on the subject of sharing profits with employees, a United States company, whose president modestly wishes us to withhold his name, reports that for some years past they have divided among employees an amount equal to two per cent. of the company's capital stock.

\* \* \*

Several industries in the St. Catharines district, including the Lincoln, Riordon, and Kinleith Paper Mills, have been hampered by shortage of coal. The complaint is made that many carloads consigned to them are tied up in Buffalo, and that the railroads are taking out coal for themselves and neglecting supplies for commercial purposes.

\* \* \*

It is stated that the underwriting of the bonds of the Ontario Pulp and Paper Mills, Limited, recently organized to operate the Imperial Pulp and Paper Mills, has been highly successful, practically the entire issue of the \$1,500,000 having been taken. A large amount of these bonds will probably go to England.

\* \* \*

At the annual meeting of the Maniwaki Light and Telephone Co., held at Hull, Que., the statement was made that an English syndicate was desirous of buying the plant and establishing a large pulp and paper mill. Maniwaki is the centre of a large pulpwood producing territory.

\* \* \*

Preparations are now advanced for the reception of machinery at the Chicoutimi Pulp Co.'s new extension, the capacity being increased from 60 tons

daily to 110 tons. As mentioned in our "Quebec Notes" last issue, twelve new 26-inch grinders will be added, besides which there will be thirty-nine flat screens, besides several centrifugals. The wet machines, hydraulic presses, etc., will remain in the old mill. It is hoped to have the mill partly in operation early in May, or the whole of it by July. G. Chabbott, formerly superintendent of the International Paper Co.'s ground wood and sulphite mills at Rumford, Me., is now with the Chicoutimi company. This company recently declared a quarterly dividend of 1½ per cent., an increase of ½ of 1 per cent.

\* \* \*

The St. Catharines Journal thus refers to the new tissue mill: In the Garden City Tissue Paper Mill at Lock 7 St. Catharines possesses the first tissue paper mill ever erected in Canada. This mill has a main building, consisting of three stories, and measuring 50 by 80 feet, and a machine-room 126 feet long by six feet wide. A 184-inch cylinder machine has been installed for the manufacture of toilet and tissue specialties. Among other innovations are two 1,000-pound beaters (another will be installed in the spring), a Jordan engine, electrical equipment by the Crocker-Wheeler Co., a 100 horse-power boiler, supplied by the Jenckes Machine Co., and five toilet paper machines. The building has been arranged for the addition of two more machines at any time when they will be required. This enterprising company will instal its own print plant, and will soon build its own ground wood plant to supply in addition the needs of the L. H. Gardner Paper Co., of Mumford, N.Y. The following are the officers of the Garden City Company: President, Wm. H. Howe, of Buffalo, N.Y.; vice-president and general manager, L. H. Gardner, of Mumford, N.Y.; secretary, Robert E. Myers, of Rochester, N.Y.; treasurer, Robert M. Myers, of Rochester, N.Y.



## FUNCTION OF STARCH IN PAPER.\*

In the manufacture of paper the most important factors in determining the quality of the finished products are: (1) the fibres, (2) the sizing agents. An unsized or water-leaf paper of even the finest quality is relatively soft and absorbent. It is also deficient in strength and cannot resist handling or mechanical wear and tear. The object of paper sizing is to diminish the capillarity by cementing together single fibres, and at the present day two methods are in use, viz., engine-sizing and tub-sizing. Engine sizing means rosin-alum sizing, and for the specific ink and water-resisting quality required in writing, printing and wrapping papers, we are practically limited to rosin. It is not my intention to discuss this type of sizing at all, but papermakers know that it is the result of a complex process, influenced by quite a number of factors, and is not merely the simple process of adding substances of water resisting quality, which property they confer on the paper.

The other method (tub-sizing, as it is called) deals with the finished sheet, and is a simpler process, colloid substances in solution, chiefly gelatin, being used. In this case the paper in the web or sheet is run through the colloid solution at a suitable temperature and concentration. The amount of size absorbed is regulated by the time of immersion, the nip or pressure on the squeezing rollers, viscosity of the size, and other factors. The paper is then dried at as low a temperature as possible by various methods. The colloid taken up by the paper coats the fibres, fills the interstices of the web with a structureless film, and reduces the capillarity of the fibres and the porosity of the paper.

This is the original method of sizing, and is at present universally used in high class papers for writing purposes.

\* Read by J. Traquair at a meeting of the Society of Chemical Industry at Glasgow.

In modern times the use of starch in paper making is intimately related with the introduction and use of various vegetable fibres. Cotton and linen fibres were the earliest paper making materials, and still produce the best paper, for in the raw state they exist as nearly pure cellulose, and therefore require little chemical treatment. The introduction of the Fourdrinier machine in 1803, and its subsequent improvements, was the means of putting paper making in the way of achieving its present industrial importance.

The first method is the one in general use, and the starch performs various functions, according to the class of paper in which it is used, the following being the principal classes:—

(1) Rosin Size.—A solution of starch is generally used to dilute down the rosin size before adding to the beater. The extent of the dilution has a considerable effect on the efficiency of the size, and the presence of starch prevents precipitation of rosin or dilution and lessens the degree of having undissolved particles of sufficient dimensions to cause rosin specks on the paper. The starch colloid also assists in the distribution of the precipitated rosin compounds.

(2) Starch is also used in special papers, such as cheque papers, where it is an important part of the tests. (See English Patent No. 748 Menzies and Bevan, 1891) as an example.

(3) E. S. Writings.—Starch finds a much larger use in this class of paper, and in Scotland, where the finest esparto E. S. writings are made, the use of starch cannot be dispensed with.

We have stated that the function of rosin size is to add water, or ink-resisting quality, to the paper, but it contributes little to the closing or compacting of the sheet. This effect is best and most commonly obtained by starch, but is, of course, also obtained by using other colloids, such as gelatine, casein, viscose, etc. (To be Continued)

## PULP AND PAPER INDUSTRY IN BRITISH COLUMBIA.

An article in the Pulp and Paper Magazine last October describing the state of the industries in the Pacific Province was not so complete as it might have been. The following additional notes, therefore, will prove of interest:—

The Swanson Bay Wood, Pulp and Forest Products Company, Limited, Swanson Bay, B.C., ninety miles south from Prince Rupert on the mainland; timber holdings, 76,000 acres of timber, principally spruce, hemlock and balsam. The plant is operated by water power. This company was organized under the name of the Oriental Pulp and Paper Company. The name was then changed to the Canadian Pacific Sulphite Pulp Company, and again later changed to its present name, as above, the Swanson Bay Wood, Pulp and Forest Products Company, Limited. This is a sulphite mill; two digesters, one 90-inch dryer; capacity, 25 tons sulphite pulp daily. The mill has been in operation one and a half years. Mr. Wood, of London, England, manager; Clarkson, Cross & Helliwell, Molsons Block, Vancouver, financial agents.

Referring to the Powell River Paper Company, Powell River, B.C., seventy miles north of Vancouver, on the mainland; timber holdings, 130,000 acres of spruce, hemlock and balsam; operated by water power. This company was originally known as the Canadian Industrial Development Company; was purchased by Dr. Brooks, of the Brooks, Scanlon & O'Brien Company, a Minneapolis corporation, in 1909. He has built a magnificent plant, having installed twelve grinders and two Pusey-Jones Fourdrinier paper machines, 148-inch and 156-inch, respectively; capacity of plant when completed will be one hundred tons news print in twenty-four hours. About July, 1911, the Wil-

lamette Pulp and Paper Company secured control of this plant. Mr. Johnson, president of the Willamette Paper Company, was elected president, and Mr. Laing, vice-president of the Willamette Pulp and Paper Company, was elected managing director. They have had rather hard luck, one of their penstocks having been carried away through some defect in the joining of the combination wood and steel penstock, and about sixty days later part of their dam being carried away on account of a treacherous quicksand. This company will probably be in operation in about four months. It is a fine plant, and will stand comparison with any plant of its size in United States or Canada.

Another large plant is that of the Ocean Falls Company, situated on Cousins Inlet, 320 miles north of Vancouver, on the mainland, with 80,000 acres of spruce and fir, and operated by water power. This company was formerly known as the Bella Coola Development Company; was purchased by Lester W. David in 1909, who organized the Ocean Falls Company, Limited, and has constructed a twenty-four grinder pulp mill, capacity 150 tons mechanical pulp in twenty-four hours, a 350,000 daily cut saw mill, built a magnificent town of about one hundred houses, hospital, church, school, hotel and large general store. The plant will be in operation in March, 1912. The president of the company is Lester W. David, of Vancouver, B.C.; vice-president, I. Hamilton Benn, of the Western Canada Trust Company, London, England; treasurer, E. F. Randolph, of Seattle, Washington; secretary, Ernest Walker, Vancouver, B.C. This company has spent about \$1,500,000 in the development of the property, and has a plant second to none in the province.

The British Columbia Wood, Pulp and Paper Company—Mills at Howe Sound, B.C., twenty-eight miles from Vancouver; 55,000 acres of spruce, fir and hemlock; operated by steam power. The company was organized in 1908, and a paper mill of ten tons daily capacity was erected, using the soda pulp process. In 1909 it absorbed the Western Canada Wood, Pulp and Paper Company, which company had been organized for the purpose of taking over the Quatsino Pulp and Power Company timber holdings on Quatsino Sound. Both the British Columbia Wood, Pulp and Paper Company and the Western Canada Wood, Pulp and Paper Company were promoted and controlled by the same people, and the amalgamation of the two was the natural sequence. The British Columbia Wood, Pulp and Paper Company started in operation in December, 1909, and ran for four months, but were obliged to close down on account of insufficient capital. Lester W. David, the owner of the Ocean Falls Company, reorganized the British Columbia Wood, Pulp and Paper Company under the name of the Colonial Lumber and Paper Mills, Limited, and proposes to build a twenty-five-ton daily capacity Kraft mill at Quatsino Sound; also a 200,000 daily capacity saw mill, to be run in conjunction with the paper mill. Construction work at Quatsino Sound will begin in April of this year. The company's paper mill, already constructed at Howe Sound, will be immediately put into operation on Kraft, with a daily output of about eight to ten tons. The officers of this company are Lester W. David, Vancouver, president; E. F. Randolph, Seattle, treasurer; Ernest Walker, Vancouver, secretary.

The Western Paper Mills—Located at Sapperton, B.C., ten miles from Vancouver, on the Great Northern Railway; a waste paper mill of about twenty-ton daily capacity. This company is installing a 90-inch cylinder machine, and their output will consist principally of

manilla, wrapping, building paper, roofing and deadening felts, carpet lining, lined and unlined boards. The president of the company is J. Barclay Bonthron, Vancouver; vice-president, A. S. White, New Westminster; secretary-treasurer, J. F. Garvin; managing director, P. N. Smith. The mill will be in operation in March. Electric and steam power.

The British Columbia Sulphite Fibre Company—Plant at Mill Creek, Howe Sound, 35 miles from Vancouver. This company have erected a magnificent plant for the manufacture of sulphite (Mitscherlich) pulp, their plant being one of the show places of British Columbia, being built of reinforced concrete throughout, operated by water power.

Twenty-five years ago Herbert Carmichael conceived the idea of manufacturing paper in British Columbia. Water power was secured on the Alberni River, about two miles from the town of Alberni, on Vancouver Island. A small 42-inch cylinder machine was installed, together with a rotary digester and three small beaters. It was to be a rag and waste paper mill, the material to be secured from Seattle and Victoria. Owing to inexperience on the part of the management and lack of funds the plant was only run about six months, and is now a matter of history. No attempt has ever been made to reorganize the company, plant and machinery having gone to rust and decay.



#### NOVA SCOTIA POWER COMPANY.

We have made reference in these columns to the formation of a company under the name of the Nova Scotia Power Company, to take over the Macleod Pulp Company, Liverpool, N.S., Halifax Tramway Company and other companies. We are informed that the work of organization has not yet been completed, but that this is being carried

on by Mr. Macleod and Mr. F. B. McCurdy, M.P., of Halifax, already well-known in connection with pulp enterprises. The promoters own two or three of the most valuable waterpowers in Nova Scotia, the only ones indeed which are generally regarded as being of commercial value. It is expected to have the company organized shortly and that the work of developing one or other of the sites will be rapidly proceeded with. Surveys and specifications



**Mr. F. B. McCurdy, M.P.**

have already been prepared and passed upon by competent hydraulic engineers. Officers of the company have not yet been appointed. The principal Nova Scotians interested are F. B. McCurdy, M.P., Estate of the late B. F. Pearson and John R. Macleod. Mr. S. Downer is manager of the Macleod Pulp Company.

Mr. McCurdy's career as a financier and business man has been one of the most striking that the Maritime Provinces have seen, for he is still well on the right side of forty. Starting at Truro in the employ of the Halifax Banking Company, which by the way was afterwards absorbed by the Canadian Bank of Commerce, largely through his efforts, he afterwards, about twelve years ago established himself in

Halifax in the brokerage business under the name of F. B. McCurdy & Company, and has experienced a series of noteworthy successes ever since. He contributed many articles to the financial columns of the Halifax Chronicle. In 1903, or thereabouts, he purchased a seat on the Montreal Stock Exchange, and two or three years later opened an office in that city, being the first Halifax broker to break into the Montreal field. The firm now has offices as well in Sydney, C.B., Charlottetown, P.E.I., and St. John's, Nfld. Mr. McCurdy has been a prominent figure in many of the noteworthy Maritime Province industrial organizations during the last dozen years, but though his career has been brilliant, his most striking quality is caution, with a solidity based on knowledge of all the data in any given case. As he described to his auditors in his after-dinner speech before the convention of the American Paper and Pulp Association, he has recently taken a plunge into pulp, and is connected with several pulp manufacturing enterprises in Nova Scotia. At the general elections last September Mr. McCurdy covered himself with glory by emerging triumphant from a hotly fought Reciprocity contest with Hon. W. S. Fielding, the Minister of Finance in the late government.



—C. B. Pride, a Wisconsin capitalist, is endeavoring to interest Nelson, B.C., city council and board of trade in the question of securing a site and cheap power to operate a pulp and 30-ton paper mill at that place. He also contemplates building a power plant on the Kootenay River. Large pulpwood areas are to be met with in this part of the province.



The Jenckes Machine Co., manufacturers of pulp mill and other machinery, Sherbrooke, Que., have been granted by that city a loan of \$100,000. They will employ 250 additional hands.



# AMERICAN PAPER AND PULP ASSOCIATION.

New York, Feb. 23, 1912.

The 35th annual meeting of the American Paper and Pulp Association in New York on the 21st and 22nd ult. was participated in with even greater interest than usual, owing to the extraordinarily important events which had affected the allied industries during the year which had passed since their previous convention. During that time, as it must have seemed to them, they had been completely forsaken by the governmental representatives of American industries, representatives who had for some time past shown a strong disposition to listen to the soothsaying of an industry which had long since shown its teeth as a bitter enemy. The convention in some respects had the appearance of a first meeting of relatives after a long-expected bereavement had at last taken place. Yet it must be confessed that the paper and pulp manufacturers of the United States are a plucky, sporty lot of men, not disposed to whimper over spilt milk. The prevailing sentiment was to make the best of things as they were, even though they were a long way from being what they might be, or as most people in the United States would say, ought to be.

The address of Arthur C. Hastings, the president, under whose energetic guidance the Association is making its influence felt more and more, was full to the brim of this spirit, though it lacked nothing of the equally important spirit not to allow the pulp and paper manufacturers' determination to get ultimate justice to waver for a moment. Briefly, he contended that he had yet to find more than one or two manufacturers who found that the profits of the business are adequate to pay for the natural wear and tear, not only on the plant, but on the individual's physical condition. The trouble was, he thought, that the paper manufacturer is afraid he will not have enough business to run his

business 100 per cent. of the time; he fears over-production, though investigation showed that except for very brief periods, this over-production has been imaginary rather than real. This is the root of the Association's strong efforts, under Mr. Hastings's guidance, to show by up-to-date statistics the exact conditions prevailing in the paper industry over the whole continent. He contended that no branch of the paper industry can be stimulated in demanding lower prices, this being one article in which price has no effect on demand, profits being measured by the difference between cost and selling price.

"There is no industry in the United States," Mr. Hastings went on to say, "that has been so investigated and legislated as has this industry. Possibly some of it is our own fault, but the main cause is that a man who buys one grade of paper that we make considers he is being abused through excessive prices charged him. No credit is given the manufacturer of paper and pulp as to his increased costs in the so-called increased cost of living, which does not mean foodstuffs necessarily, but every one article that goes into the manufacture of paper and pulp. The same publication that rants about the injustice they are subjected to in the extra price of paper over what they have paid for the last ten years, is claiming that the high cost of living is responsible for the advances in everything—except paper—and yet a balance will show a greater advance in the cost than in the finished product. While I believe the intent of Congress was not to give our market freely to all nations, the effect is such, through the passing of Section 2 of the so-called reciprocity act, that we are obliged to defend ourselves through the Customs Courts. The attempt of the publishers has been to create a general tariff uneasiness, and has awakened the manufacturers of all



other commodities to the danger confronting them."

Wednesday, the first day of the convention, was devoted to meetings of the various sub-sections, reports from which were presented to the general meeting on Thursday.

That of the wrapping paper division, presented by H. W. Stokes, contained the following interesting statement on Kraft production:

The production of wrappings during 1911 has also been influenced by the increasing demand for kraft paper, one ton of which, owing to its light weight, will go as far as two tons of ordinary wrapping paper or fibre paper. While the quality of the domestic product is not yet as good as the foreign, several of the mills in this country are turning out a sheet which appears to answer all the requirements demanded, and with more experience and a further development of the sulphate process in this country, our own mills should be able before long to supply all of this grade which our home consumption demands. Those who make domestic kraft paper are still protected by the tariff, but should the present duty be removed, it is evident that its further profitable manufacture would be impossible. There is undoubtedly too great a lack of uniformity in the grades of manila papers made by the different mills, which probably accounts for the fact that this kind of paper is still selling at a price close to cost of making.

Other reports referred to the situation in writing and tissue papers, boards, specialties, chemical pulp, etc.

The news and ground wood division's report had this reference to recent legislation:

"July 26 last the reciprocity act, so-called, became a law, and so far as the paper pulp provision is concerned, which was covered by separate section, became immediately effective and regardless of failure of ratification by Canada. The result is a material increase in the im-

portation of news from Canada. So far as the figures which have been obtainable show, 50 per cent. of the news imported from Canada since that time has come in free, and about 80 per cent. of mechanical ground wood pulp."

Another report was that of Arthur D. Little, the official chemist, who dwelt upon the extent to which paper making in Germany has established itself on a scientific basis.

At the banquet Wednesday evening, the attendance was larger than ever before. Among the Canadians present were Mr. F. A. Ritchie, of Ritchie and Ramsay, Toronto; F. B. McCurdy, M.P., Halifax; F. L. Ratcliff and J. G. Sutherland, of Douglas & Ratcliff, Toronto.

Mr. McCurdy, in a neat and well received speech, referred to the elections of last September. The appeal, then responded to, he said to his auditors, was simply on the basis of whether or not Canada wished to change its fiscal policy. The relations between Canada and the United States, so far as Canada is concerned, were never more cordial than at the present day. They looked upon that appeal as a question as to whether or not they should continue to follow the protectionist policy, or whether or not they should continue to policy of free trade. That was the issue and the answer was emphatic. The present government at Ottawa is committed to the policy of adequate protection, and this fact should be noted by all men who control business in Canada capable of further expansion. In other words, that result assures to invested capital in manufacturing enterprises in Canada adequate protection, so that they may carry on their business with the assurance that their investment in Canada will be properly safeguarded. The public mind in Canada is firmly fixed on the fact that Canada should continue to develop and manufacture its raw products in Canada by its own hands, to be offered for sale in the most highly developed form possible.

## UTILIZATION OF CANADA'S PULPWOOD.

R. H. Campbell, Dominion Director of Forestry, commenting on the recently issued figures on the production of pulpwood in Canada, says:—

Over 60 per cent. of the pulpwood cut in Canada during 1910 was sent out of the country without further labor being expended on it. The amount paid for this wood was \$6,210,042, or an average of \$6.58 per cord. As the average paid by Canadian mills was \$6, this is an average of 58 cents per cord more paid for exported pulpwood at the point of shipment.

In the United States approximately two-fifths of the pulpwood imported by that country is manufactured into mechanical pulp and three-fifths into sulphite pulp, and a cord of wood produces about one ton of mechanical pulp, or half a ton of chemical pulp. This means that from the 943,141 cords of Canadian pulpwood sent to the United States 377,256 tons of mechanical pulp were made, and 282,992 tons of sulphite pulp. The value of these 660,248 tons of pulp, for which, in the form of pulpwood, Canada received \$6,210,042, was, at the average price (\$20.49 per ton), paid in 1910 by United States importers of woodpulp, \$13,528,481. Thus Canada did not get one-half the amount she would have received if all pulpwood were converted into pulp on Canadian soil. Authoritative information supplied by the Department of Customs leads to the statement that the total pulpwood export was cut from the various Provinces in the following amounts and values: 779,000 cords, worth \$5,000,000, from the timber limits of Quebec; 90,000 cords, worth \$647,000 from New Brunswick; and 74,000 cords, worth \$473,000, from Ontario.



The Meyer-Thomas Co.'s plant at Granby, Que., for making different kinds of boxes, is being extended.

## PULP AND PAPER MARKETS.

Toronto, March 11, 1912.

The comparative dullness which was in evidence in the newsprint market during the earlier part of the year may now be said to have disappeared. Prices are steady. A large part of the increased demand comes from the States, and some of the Canadian mills find it difficult enough to keep up with orders.

The book and writing mills are also operating to capacity. Some, indeed, are having to purchase from outside to keep up with contracts.

The position in wrappings is slowly improving though Kraft is still on the easy side in regard to prices.

The market for coated paper is settling down a little after the recent unsettlement, due to cutting of prices through new mills coming into the field.

Demand for paper stock is good, with a tendency to stiffen quotations in some lines.

Owing to the improvement of water conditions in both Eastern and Western States, the demand for pulp from the United States has fallen off considerably, and prices here have shown a drooping tendency. In fact, the "open market" for groundwood is somewhat below contract rates. The contract price is about \$25 per ton, while open market price is nominally \$22.50, with comparatively few sales.

The demand from the States for Canadian pulpwood has been brisk, and the average quotation for high-grade spruce, delivered at Niagara Falls, is around \$13.50 per cord.

In Canada, frosty conditions have continued to a late date, and the mills have not yet got over the handicap presented by these conditions. A break-up of the winter is, however, to be expected at any time in the near future. Stocks are not large, and it is maintained by some that prices will make no material drop for some time.

---

---

# Zaremba Evaporators

FOR RECOVERY OF

# SULPHATE OR SODA

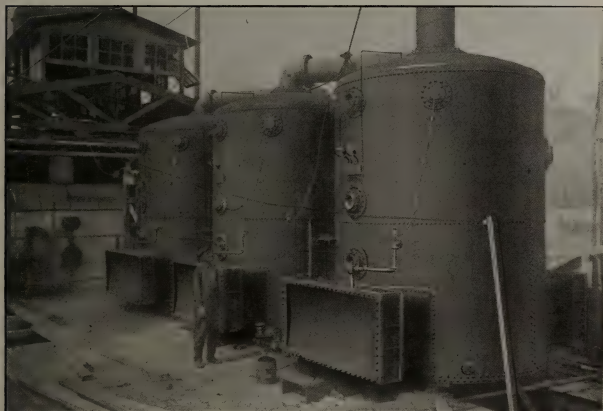

¶ After long experience with other types of evaporator, the largest American manufacturer of soda pulp installed this Zaremba Patent Triple Effect. ¶ The results secured have proven that the best features of old practice are combined with the latest improvements of value. ¶ Our Automatic Liquor Control is remarkable in that it really regulates. ¶ The largest Pulp Mill Evaporator in use is of our make.

## ZAREMBA COMPANY

Morgan Building  
Buffalo, U.S.A.

---

---

## We quote:—

News print, rolled .....	\$1.90 to \$2.00
News print, sheets .....	2.15 to 2.25
Book papers—Carload lots	
No. 3 .....	4¼ to 4½c.
Book papers—Broken lots	
No. 3 .....	4½ to 4¾c.
Carload lots No. 2 .....	4¾c.
Broken lots No. 2 .....	5½ to 5¾c.
Carload lots No. 1 .....	5½ to 6¼c.
Broken lots No. 1 .....	6 to 6¾c.

## Wrappings—

Manila B. ....	2½ to 3¼c.
Fibre . . . . .	3½ to 4 c.
No. 2 Manila . . . . .	3¼ to 3¾c.
No. 1 Manila . . . . .	3½ to 4 c.
Kraft . . . . .	4¼ to 4½c.

## Pulp—

Ground wood (at mill) . . . . .	\$15 to \$17
Sulphite (bleached) . . . . .	\$53 to \$55
“ (unbleached) . . . . .	\$42 to \$44

## Waste Papers—

	Per 100 lb.
	F.o.b. Toronto.
No. 1 Hard White	
Shavings .....	\$1.65 to \$1.75
No. 2 Hard White	
Shavings .....	.....
White Envelope Cut-	
tings .....	\$1.65 to \$1.75
No. 1 Soft White	
Shavings .....	\$1.45 to \$1.50
No. 2 Soft White	
Shavings .....	\$1.25
No. 3 Soft White	
Shavings .....	\$1.10

White Blanks .....	\$1.10
Mixed Shavings .....	35 to 37½c.
Heavy Ledger .....	\$1.27½ to \$1.40
Ordinary Ledger .....	\$1.00 to \$1.10
No. 1 Flat Books .....	80 to 90c.
No. 1 Book Stock .....	75 to 80c.
No. 2 Book Stock .....	39½ to 40c.
No. 1 Manila Envelope Cuttings...	\$1.20
No. 1 Print Manilas .....	65c.
Railway Manilas .....	55c.
Folded News Overissues .....	45c.
Folded News .....	45c.
Crushed News .....	.....
No. 1 Mixed Papers .....	25 to 35c.

## Rags (New and Old)—

Per 100 lb.

1st Old White Cottons .....	\$2.00
2nd Old White Cottons .....	.....
Thirds and Blues .....	\$1.25 to \$1.45

## Roofing Stock—

Flock Satinets .....	75 to 80c.
Ordinary .....	55 to 60c.
Tailor Sweepings .....	55 to 57½c.
No. 1 White Shirt Cuttings	\$4.75 to \$5.00
No. 2 White Sheet Cuttings	.....
Fancy Sheet Cuttings .....	\$3.65 to \$3.75
New Blue Prints .....	.....
New Blue Overalls .....	\$3.42½ to \$3.65
New Black Overalls .....	\$1.60 to \$1.70
New Black Linings .....	\$1.60 to \$1.75
New Unbleached Cottons .....	.....
Bleached and Unbleached Shoe Clips	.....
New Light Flannelettes .....	\$3.75 to \$4.40
New Light Shirt Cuttings	\$3.90 to \$4.35
Light and Dark Cords .....	.....

**CHURCHILL & SIM**

29 CLEMENTS LANE, LONDON, E.C.

And at Manchester

**WOOD PULP AGENTS**Telegraphic Address:—  
“CHURCHILL, LONDON.”A.B.C. CODE  
5th Edition

---

# EMERSON MANUFACTURING CO.

## LAWRENCE, MASS.

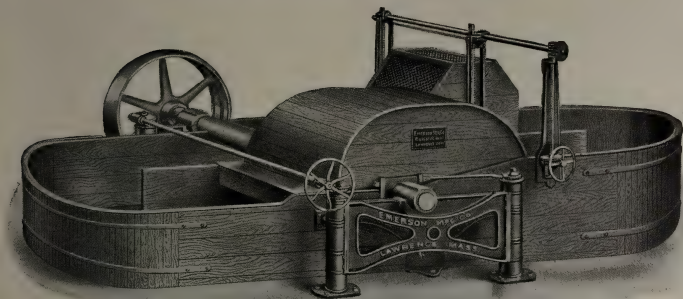

Beating and Washing Engines  
Paper Mill Machinery

---

**THE UNITED WIRE WORKS LTD,**  
EDINBURGH, GLASGOW & NEWCASTLE-ON-TYNE  
**FOURDRINIER WIRES, CYLINDER WIRES,**  
AND WIRE CLOTH OF ALL KINDS.

AGENTS, ARTHUR P. TIPPET & CO. 8 PLACE ROYALE MONTREAL.  
WIRES HELD IN STOCK AT MONTREAL FOR PROMPT DELIVERY.

# ARTHUR P. TIPPET & CO.

Agents and Importers

**PAPER MILL SUPPLIES**

**SULPHUR      FELTS**

Sal Ammoniac,

Borax,

Santitie, etc.

**MONTREAL**

-

**TORONTO**



If you have not ordered a copy of the new "Canadian Pulp and Paper Directory," do it now. Your promptness will save you \$1. The price to non-subscribers, after publication, will be \$3. To subscribers before publication \$2.

Address :

**BIGGAR-WILSON, LIMITED**  
 CONFEDERATION LIFE BLDG,  
 TORONTO

The ::

## West End Engine Works Co.

PAPERMAKERS'  
 ENGINEERS

- - - EDINBURGH

Specialists in all kinds of  
Papermaking Machinery

Duplex, Angle and Square Cutters, Vickery's Laying Machines,  
 Improved Umpherston Beaters, &c., &c.

PRICES ON APPLICATION

Telegrams : West End, Edinburgh

IMPROVED WARREN PATENT

# Double Drum Winder

With Slitter Attachment Combined

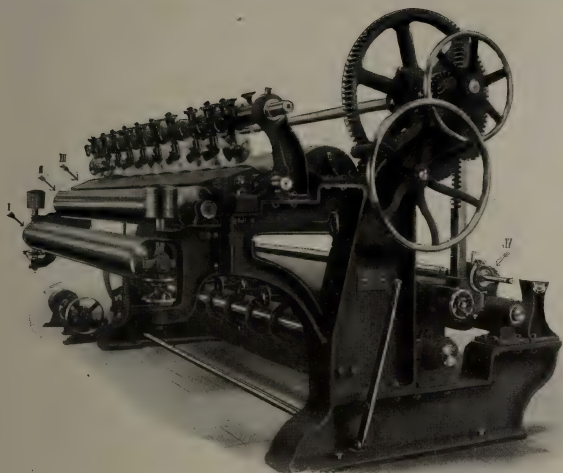

REAR VIEW SHOWING SLITTERS.

REFERENCE :

- I—8-inch Brass Spring Roll.
- II—8-inch Brass Carry Roll
- III—8-inch Adjustable Draw Board.
- IV—Adjustable Core Shaft Box.

Compare this Winder with Others

BUILT BY

## Ticonderoga Machine Works

TICONDEROGA, N.Y., U.S.A.

ALL KINDS OF  
 Machines for Paper, Pasteboard,  
 Cardboard, Cellulose  
 and Pulp Mills

Calenders      Patent Beaters  
 Winders      Calender Roll Lathes  
 Filters (Füllner's Construction)  
 Cutters      Cone Refiners  
 High Power Grinders      Paper Machines  
 Kollergänge (Edge Runners)

FIRST-CLASS REFERENCES

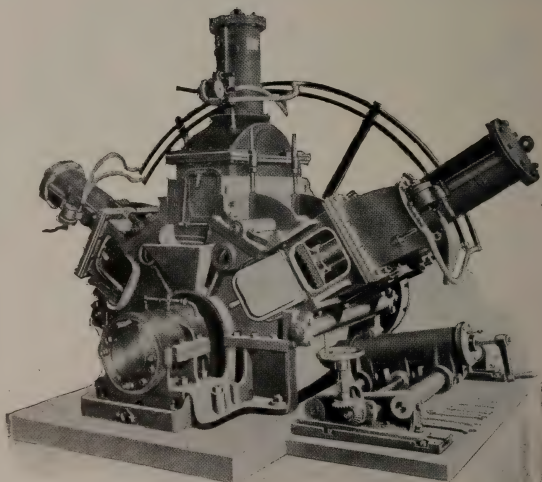

MOST MODERN CONSTRUCTION

Founded 1854

**H. FÜLLNER**

WARMBRUNN  
SILESIA  
GERMANY

Prizes won at all exhibitions where machines have been shown.  
Turin 1911 "Grand Prize," highest award.

# CLASSIFIED ADVERTISERS' INDEX.

If you fail to find what you want in these columns, write us and the desired information will be gladly supplied.

## Architects and Engineers

Ambrusen Hydraulic Con. Co.  
Fred C. Anderson  
Clark & Lyford  
F. W. Dean  
J. A. DeCew  
Eaton & Brownell  
Fibre Development Co.  
Geo. F. Hardy  
Herbert S. Kimball  
International Process Co.  
Arthur D. Little, Inc.  
R. S. Lea & H. S. Ferguson  
Lyford, Clark & Lyford  
H. B. Prather  
T. Pringle & Son  
Stebbins Eng. & Mfg. Co.  
R. O. Swezey  
Jos. H. Wallace & Co.

## Barkers.

Green Bay Barker Co.  
Jenckes Mach. Co.  
Waterous Engine Works.

## Barker and Chipper Knives.

Crookes, Roberts & Co.  
Peter Hay Knife Co.  
A. P. Tippet & Co.

## Beaters.

Dayton Globe Iron Works  
Emerson Mfg. Co.  
Holyoke Mach. Co.  
E. D. Jones & Sons Co.  
Valley Iron Works  
Waterous Engine Works

## Beater Rolls.

J. A. DeCew  
J. Marx & Co.

## Belting.

Dom. Belting Co.  
General Supply Co.  
F. Reddaway & Co.  
Sadler & Haworth

## Bleaching Powders.

Hooker Electro-Chemical Co.  
Winn & Holland

## Boilers

John McDougall Caledonian Iron Works

## Bond Papers.

Northern Mills Co.

## Book Papers.

Canada Paper Co.  
Northern Mills Co.

## Brass Wire Cloth, Fourdrinier W res.

Geo. Christie, Ltd.  
J. M. Douglas & Co.  
Herman Finch  
C. H. Johnson & Sons, Ltd.  
A. P. Tippet & Co.  
United Wire Works.  
P. P. Westbye

## Calendar Rolls.

Camel Hair Belting  
F. Reddaway & Co.  
Farrel Foundry & Mach. Co.

## Chemicals, Colors, etc.

Brunner, Mond & Co.  
Gewerkschaft Sachtleben  
A. Klipstein & Co.  
Paper Makers' Chemical Co.  
United Alkali Co.  
Wilson-Paterson Co.

## China Clay.

China Clay Co.  
A. Klipstein & Co.  
C. A. Meincke & Co.  
Paper Makers' Chem. Co.  
Wilson-Paterson Co.

## Chippers

Carthage Machine Co.

## Coated Paper.

Canada Coating Mills  
Canada Paper Co.

## Conveying Machinery.

Jeffrey Mfg. Co.

## Digester Lining.

Panzl Digester Lining Co.  
Preston's Digester Lining Co.  
Stebbins Eng. & Mfg. Co.

## Digesters

Swenson Evaporator Company

## Drainer Bottoms.

Samuel Snell Co.

## Evaporators

Ernest Scott & Co.  
Swenson Evaporator Co.  
Zarembo Company

## Exporters

Parsons Trading Company

## Felts.

F. Bredt & Co.  
Dallyn, Jardine & Co.  
Hamelin & Ayres Co.  
C. H. Johnson & Sons, Ltd.  
Penman's Ltd.  
Joseph Porritt & Sons.  
J. H. Spencer & Sons  
A. P. Tippet & Co.

## Grinders.

Dayton Globe Iron Works  
Glens Falls Mach. Co.  
Holyoke Machine Co.  
Jenckes Machine Co.  
Waterous Engine Works.

## Kraft Paper.

N. B. Pulp & Paper Co.

## News-Paper, Wrappings, etc.

New Brunswick P. & P. Co.  
Riordon Paper Co.

## Paper and Pulp Dealers

Atterbury Bros.  
Castle, Gottheil & Overton.  
Parsons Trading Co.  
Pulp and Paper Trading Co.  
A. Wertheim & Co.  
Riordon Paper Co.

## Paper Stock, Rags, etc.

Atterbury Bros., Inc.  
J. Christie Co.  
R. Hough  
The Howell Co.  
E. Pullan  
J. R. Walker & Co.

## Paper and Pulp Mill Machinery.

Appleton Machine Co.  
W. G. Ashdown  
Baker & Shevlin Co.  
Beloit Iron Works  
Bentley & Jackson  
James Bertram & Son, Ltd.  
Bertram's, Limited  
The Black-Clawson Co.  
Canadian Boving Co.  
Carthage Machine Co.  
Dayton Globe Iron Works Co.  
Dillon Machine Co.  
Emerson Mfg. Co.  
Farrel Foundry & Machinery Co.  
M. Garland Co.  
Glens Falls Machine Works.  
Green Bay Barker Co.  
Harmon Machine Co.

## Holyoke Machine Co.

Jenckes Machine Co.  
E. D. Jones & Sons Co.  
C. H. Johnson & Sons, Ltd.  
Jas. Milne & Sons.  
Moore & White Co.  
Marx, J. & Co.  
B. F. Perkins & Son.  
Rice, Barton & Fales  
Ryther & Pringle.  
Sandy Hill Iron & Brass Works.  
Ernest Scott & Co.  
Sherbrooke Machinery Co., Ltd.  
S. Morgan Smith.  
Stebbins Engineering & Mfg. Co.  
Swenson Evaporator Co.  
Ticonderoga Machine Works.  
Valley Iron Works.  
J. M. Voith.  
Charles Walmsley & Co.  
Chr. Wandel.  
Wandel Screen Mfg. Co.  
Waterous Engine Works Co. Ltd.  
P. P. Westbye.  
Zarembo Co.

## Paper Testers.

Dohler & Mudge.

## Pipes (Wooden)

Eastern Pipe & Construction Co.

## Pumps.

Lawrence Machine Co.  
Lawrence Pump & Engine Co.  
John McDougall Caledonian Iron Works.  
Smart-Turner Mach. Co.

## Rosin Size.

Paper Makers Chemical Co.  
Vera Chemical Co.  
United Alkali Co.  
Wilson-Paterson Co.

## Screen Plates.

Union Screen Plate Co. of Can.

## Screens.

W. G. Ashdown  
Harmon Machine Co.  
Sherbrooke Machinery Co.  
J. M. Voith.  
Chr. Wandel.  
Wandel Screen Mfg. Co.  
Waterous Engine Works.  
P. P. Westbye.

## Sulphur.

Union Sulphur Co.

## Tanks.

John McDougall Caledonian Iron Works  
G. Woolford Wood Tank Mfg. Co.

## Transmission Machinery.

Dodge Manufacturing Co.

## Travelling Cranes.

Advance Mach. Co.  
Hugh R. Blethen  
Northern Eng. Co.  
Smart-Turner Mach. Co.

## Turbines.

Dayton Globe Iron Works.  
S. Morgan Smith Co.

## Water Wheels.

John McDougall Caledonian Iron Works  
Dayton Globe Iron Works.  
Holyoke Machine Co.

## Wood Pulp Agents.

Castle, Gottheil & Overton  
Parsons Trading Co.  
Scandinavian Amer. Trading Co  
A. Wertheim & Co.

# Worthington Pumps

SPECIALY DESIGNED TO MEET  
... THE CONDITIONS OF ...

## Pulp & Paper Mills

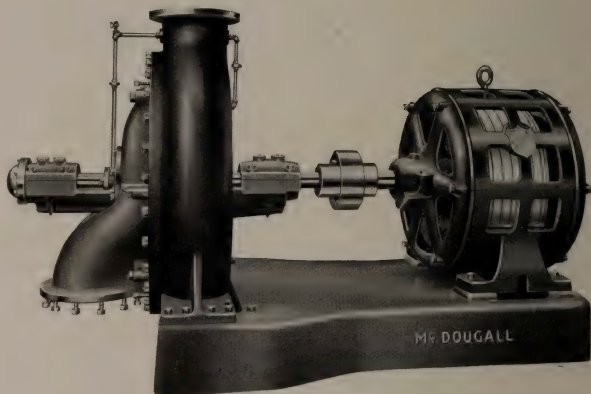

**Turbine Pump Capacity 4,000 U.S. gals. per min.  
for Water Supply.**

---

SEE BULLETIN 108

---

**THE JOHN McDOUGALL  
Caledonian Iron Works Co.  
LIMITED**

**Works**

-

-

-

**Montreal**



The logical  
drive  
for a paper  
or pulp mill  
IS

“**AMPHIBIA**”



(WATERPROOF)



**Leather Belting**

because it IS  
absolutely waterproof

MADE BY

*Sadler & Haworth*

Tanners and Manufacturers.

TORONTO  
511 William St.

ST. JOHN, N.B.  
89 Prince William St.

MONTREAL  
27 Melinda St.

WINNIPEG  
244 Princess St.

VANCOUVER  
217 Columbia Ave.

For over thirty-five years the makers of the  
best leather belts.

PRIME . . . .  
CANADIAN CHICOUTIMI,  
P.Q., CANADA.  
SPRUCE PULP

SUPPLIED BY THE

**CHICOUTIMI**  
**Pulp Co.**

Production: About 100,000 tons.

SOLE AGENTS:

**BECKER & CO.**

LIMITED

64 CANNON ST., - LONDON.

# PAPER AND CLOTH SPECIALTIES

For Rent and Club Cards, Pattern Cards, Map Printing,  
Label Printing, Envelopes, Etc., Etc.

*Cloth Lined Papers. Cloth Centred Papers and Boards. Cloth Lined, Chromo and Enamel. Cloth Lined Boards and Cards, (surfaced and enamelled). Cloth centred Boards, (surfaced and enamelled). Manilla Surfaced Boards and Cards.*

ALSO

*Enamel'ed Blotting.  
Art Papers.*

*Paste Boards.  
Chromo and Surface Papers.*

Customers' requirements in specialties are carefully considered and experiments conducted if necessary.

**ALBERT E. MALLANDAIN,**  
MANUFACTURER

OFFICES : 51 Cheapside  
London, E.C.

MILLS : Park Royal  
Willesden, London, N.W.

## HERMANN FINCKH

REUTLINGEN

*Established 1879*

GERMANY

---

# FOURDRINIER WIRES

---

**SULPHITE - MACHINE WIRES**  
**CYLINDER WIRES**

---

**P. P. WESTBYE, - Peterborough, Ontario**

*Sole Agent for Canada*

**PRESTON'S**

# Lining for Sulphite Digesters

TOTAL THICKNESS ONLY 2½ TO 2¾ INCHES

Resists the action of the acid and ensures absolute protection to the Digester Plates.

Great durability, therefore large saving in upkeep and repairs.

Larger internal space and increased production on account of the small thickness occupied.

Extensively adopted by Scandinavian and Continental Mills.

Over 200 Digester Linings in work and on order.

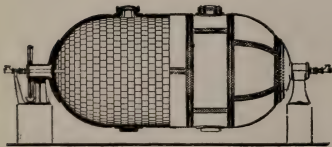
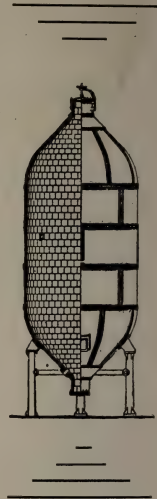

Telegraphic Address :

“**PRESTONS, RADCLIFFE.**”

CODE USED, A. B. C. 4TH & 5TH EDITION.

*Full Particulars and Prices on application to SOLE MANUFACTURERS*

## PRESTON'S DIGESTER LINING CO., LIMITED

RADCLIFFE, near Manchester, Eng.

# Fans for the Paper Mill



We make a specialty of Ventilating and Exhaust Fans for all kinds of Paper Mill Work. Keep a copy of our No. 85 Catalog in your files for ready reference.

**B. F. PERKINS & SON, Inc.**  
**HOLYOKE, MASS.**

**FROZEN PULP AND DRY PULP  
IN A**

## Ryther Shredder

Is shredded at the rate of 5 tons per hour. 17 to 25 H. P. required. The above figures are *dry weight* and absolutely guaranteed.

RELIEVE YOUR BEATERS and INCREASE QUALITY and PRODUCTION. Write for full Particulars.

---

---

**Ryther & Pringle Company**  
Carthage, N.Y.



VALLEY IRON



WORKS COMPANY

# BEATING AND WASHING ENGINES

IRON OR WOOD TUBS

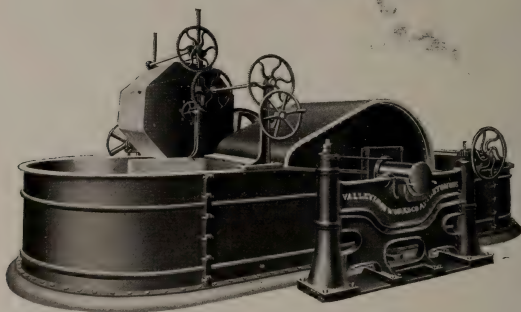

PERFECTION IN EVERY DETAIL.

Beating, Washing and Bleaching Engines. Barkers—Barker Attachments—Chippers—Rechippers—Chip Screens (Revolving)—Knot Screen (Revolving)—Diaphragm Screens—Felt Washers—Deckers (Single and Double)—Stuff Chests (Vertical and Horizontal)—Tanks (Blow Off, Acid and Water)—Pulpwood Saws (Friction and Steam Feed)—Pulpwood Splitters (Vertical and Horizontal)—Shredders and Special Washers for old Paper Stock—Wet Machines and Patent Roll Skinners—Bronze, Semi-Steel, Lead and Iron Castings.

Manufacturers of Paper and Pulp Making Machinery in

*All Standard Forms. — Many Special Designs.*

ENGINEERS, FOUNDERS AND MACHINISTS

*Correspondence Invited*

VALLEY IRON WORKS COMPANY

APPLETON, WIS., U.S.A.

---

---

FARREL FOUNDRY AND MACHINE  
COMPANY

ANSONIA, CONN., - - U. S. A.

Largest Manufacturers in the world of

**CHILLED ROLLS**

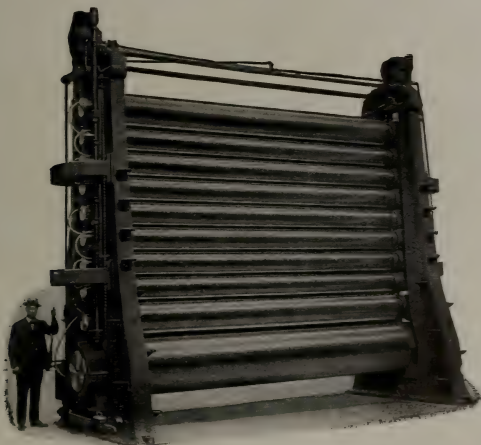

**CALENDERS**

*WITH PATENT HYDRAULIC LIFT*

**ROLL GRINDING MACHINES**

---

---

Would YOU like to enlarge your Business and find new Customers in all parts of the world? If so, ADVERTISE in

# “THE PAPER-MAKER AND BRITISH PAPER TRADE JOURNAL.”

THE LEADING AND MOST POPULAR TRADE ORGAN.

THE ADVERTISER **IS** GOOD FOR **THE** READER

We recently received the following letter:—

“We have hesitated over the matter, as we are at present so busy as to regard further advertising as almost superfluous.

“On the whole, however, we find it pays us better to have to refuse orders than to hunt after them, and will ask you therefore to insert our advertisement on same terms as last.

“We enclose herewith amended matter for advertisement, and shall be glad to have proof of same at your early convenience.”

We are constantly in the receipt of gratifying letters relative to the usefulness of our Journal, and we have pleasure in printing the following:

“Gentlemen,

We beg to advise that we have not as yet received the June number of ‘THE PAPER-MAKER AND BRITISH PAPER TRADE JOURNAL.’

We like the publication so well that we should be very sorry indeed to miss a copy of it.

Thanking you in advance for your kind attention,

We are, dear Sirs, yours very truly,  
F. R. KEYES & SON.  
20 Broad Street, New York.”

## S. C. PHILLIPS & Co.'s STANDARD PUBLICATIONS

### The Paper-Maker

AND BRITISH PAPER TRADE JOURNAL.

Published on the 1st of each month. Price 1s., by post 1s. 6d. Annual Subscription 12s. 6d. post free.

**The Stationery World,  
Printing and Allied Trades,  
AND FANCY GOODS REVIEW.**

Published on the 25th of each month. Price 6d. by post 7½d. Annual Subscription 5s. post free.

Chief Offices:

47 CANNON STREET, LONDON, E.C. (ENGLAND).

### The Paper Box and Bag Maker.

Published on the 19th of each month. Price 6d., by post 7½d. Annual Subscription 6s. 6d. post free.

**Phillips' Paper Trade Directory  
of the World.**

15s. 6d., post free to all countries.

NEW EDITION FOR 1911 NOW READY.

Specimen Copies and Advertisement Rates  
FREE OF APPLICATION.

# “LAWRENCE” Centrifugal Pumps

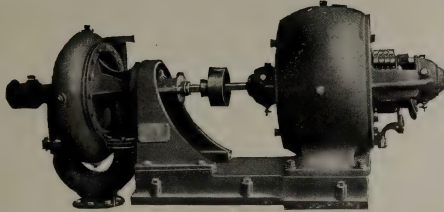

High-grade Pumping Machinery  
for all Purposes

PAPER MILL WORK  
A SPECIALTY

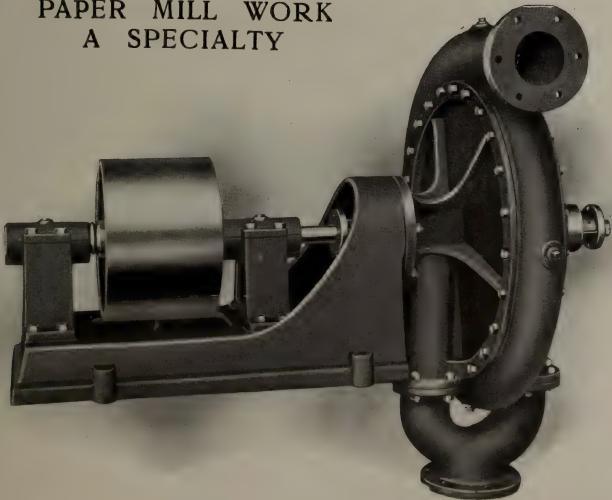

Let us figure on your requirements

**Lawrence Machine Company**  
LAWRENCE - MASS.

**UNDER MANAGER.**—Young man, 14 years' practical experience in English mill making long elephants, news, all-wood printings, cream laid, etc. Experienced mill chemist—testing of papers, fibres, etc. Highest references. Address H. C., c/o Pulp and Paper Magazine.

**WANTED.**—Superintendent for a new 150-ton ground wood mill. One with technical education preferred. Please state education and experience in full; also give age, if married or single, and salary asked for. Address Box 27, care Pulp and Paper Magazine, Toronto.

As we are using all our Water Power at our Pulp Mill for electricity, we are disposing of the Pulp Mill Machinery—including Millard Patent Grinders which were in use only a few months and are absolutely as good as new, also Wet Machines, Barkers, Screens, Pumps, Piping, Shafting, Stones, etc., etc., all in good condition. Full information will be given upon application.

Apply Box "A,"

Pulp and Paper Magazine,

Toronto.

### FOR SALE.

A 92-inch Fourdrinier machine, complete, now running in Canadian mill, to make room for a larger machine.

For particulars, etc., address Box 25, Pulp and Paper Magazine.

**PAPER MILL ENGINEER.**—Technical graduate, ten years' experience, now consulting engineer for one of the best paper mills in United States, wants change. Open for engagement in near future. Will give part or whole time. Apply Box 26, Pulp and Paper Magazine, Toronto.

**A GENTLEMAN** from Scotland, resident in Toronto, having had practical experience in all departments of paper making, would like to hear from firms to whom his services might be of use. He has had wide and varied experience "on the road" in the printing and stationery trades, also the manufacture of paper bags. Box (S.W.) Pulp & Paper Magazine.

**WANTED IMMEDIATELY**—Master mechanic, machinists, millwrights and pipefitters for Canadian soda, pulp and paper mill now under construction. Only experienced men need apply. State wage and give references. Apply Box Box D, Pulp and Paper Magazine.

**GEWERKSCHAFT SACHTLEBEN**

Homburg-Niederrhein  
GERMANY

Largest Makers  
of all Qualities

**Blanc Fixe**

Three  
Varieties

Bright

Matt or Dull

Photographic



**SCOTT'S IMPROVED RECOVERY SYSTEMS**  
**FOR**  
**SODA, SULPHATE AND SULPHITE**  
**SPENT LIQUORS GIVE THE**  
**MAXIMUM ECONOMY AND EFFICIENCY**

*The* **PRINCIPLE**  
*The* **DESIGN**  
*The* **CONSTRUCTION**  
*The* **OPERATION**  
*The* **RESULT** } **IS RIGHT**

Complete Installations made by "THE FIRM WITH THE EXPERIENCE"

**ERNEST SCOTT & CO. MANUFACTURING ENGINEERS**  
**FALL RIVER, MASS. and MONTREAL, P.Q.**

**SODA OR SULPHATE**

RECOVERY SYSTEM  
 MAXIMUM EFFICIENCY      MINIMUM LOSSES

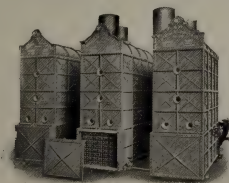

**WELDED DIGESTERS      MULTIPLE EFFECT EVAPORATORS**  
**AND OTHER PULP MILL EQUIPMENT**

**SWENSON EVAPORATOR CO.**

945 Monadnock Bldg. . . . . CHICAGO

---

---

**CHR. WANDEL** REUTLINGEN  
GERMANY

---

ESTABLISHED 1869.

Manufacturer of the

**“ORIGINAL WANDEL”**  
**Rotary Sulphite Pulp Screen**

---

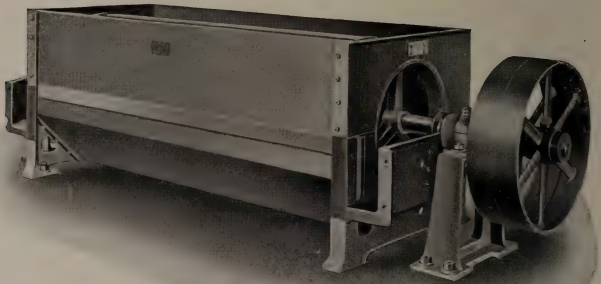

---

Satisfactory service sure. Best by test. Beware of imitations.

---

Largest screening surface, combined with small requirement of room. Absolutely reliable and noiseless work.

---

No contact of the pulp with iron parts. Simple, durable, perfect. Price very moderate.

---

The system now adopted by the most important Sulphite Fibre Mills of Europe.

---

Prices and further particulars gladly furnished.

---

---

**Agent for Canada Wanted**

---

---

HIGH GRADE  
**“VICTORIA” TURBO PUMPS**

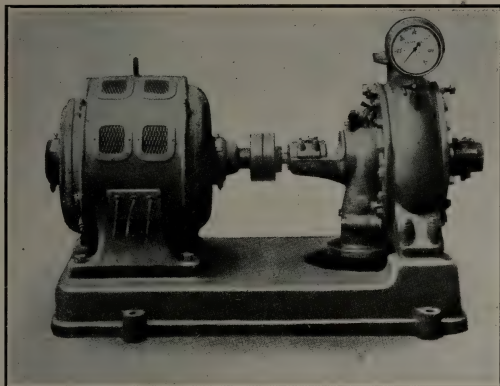

---

Suitable  
for all condi-  
tions. Water,  
pulp, caustic  
or acid. High-  
est efficiency  
Flat charac-  
teristic curve.  
Unrivalled  
workmanship.

---

**THE CANADIAN BÖVING COMPANY, LTD.**  
164 BAY STREET : : : : TORONTO

**A GOOD JORDAN ENGINE**

BUILT IN 3 SIZES.

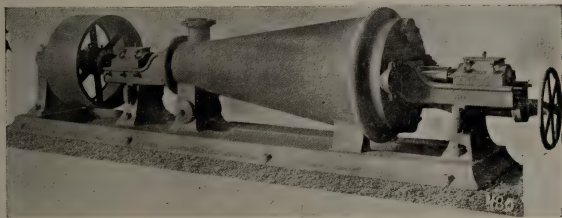

**THE BLACK-CLAWSON CO.**

HAMILTON, OHIO, U.S.A.

Builders of **PAPER MAKING MACHINES** and machinery  
for Paper and Pulp Mills. Our machines are completely erected in shop  
on cast iron levelling plates and carefully inspected before shipment.

*Write for Catalogue.*

**BRITISH MARKETS.**

London, Feb. 23rd, 1912.

Little or no business is passing in mechanical pulp, and the market is almost at a standstill. Buyers show no disposition to accept makers' views regarding prices.

There is rather more activity in the market for chemical pulps, and prices rule very firm.

The market for chemicals is steady, with an improving demand. Ammonia alkali, 58 per cent., is quoted £4 5s. to £4 10s. f.o.b. Liverpool; bleaching powder, £4 15s. per ton, f.o.b. Manchester; caustic soda (high-strength), £10 2s. 6d.; soda crystals, £2 12s. 6d.; and salt cake, £2 2s. 6d.

Business in home rags is fairly active at firm prices. Prices for foreign rags have a marked upward tendency under a good demand.—World's Paper Trade Review.

**NORWEGIAN MARKETS.**

According to last reports there is hardly any unsold pulp in Norway. Small prompt parcels have been sold recently at varying prices, advancing gradually to Kr. 50.00 (\$13.33) for good ordinary quality f.o.b. steamers here.

The makers will hardly be able to supply all they have sold for winter delivery, and for future deliveries it is impossible to obtain reliable quotations.

It may, however, be anticipated that extraordinary figures will be recorded before the winter is over. Before the water situation became quite so desperate as it now is, some fairly large lots for delivery during 1912 were sold at about Kr. 40.00 (\$10.67), and those buyers may consider themselves very lucky. It is rumored that the buyers in England, especially in the Manchester district have agreed to put off buying as long as possible, hoping, as has been the case so many times before, to bring about anxiety among the sellers, and thus force down the prices. The sellers, however, have no reason for anxiety; on the contrary, considering the great and unavoidable limitation of production that has taken place during the winter owing to the lack of water, they may await future chances with confidence.

During 1911, in Norway, in all more than a dozen new paper machines have been erected, besides a few which have been rebuilt after having been destroyed by fire.



—The employees of the Lincoln Paper Mills at Merritton were a week or two ago given a bonus of 6 per cent. of their total wages during the year, this having been the custom during the past eleven successive years. We regret to hear of the death of the mother of W. D. Woodruff, managing director of the mills, in her 85th year.

# TOWNSEND

## ELECTROLYTIC CELL

2,500-5000 AMPERE UNITS. ALKALI AND CHLORINE.  
CAUSTIC SODA. BLEACHING POWDER. — CHLORINE  
FOR ORES. LICENSES GRANTED. CANADIAN PATENTS  
91939 - 105088 - 105089.

**HOOKER ELECTROCHEMICAL COMPANY**  
40 WALL STREET, NEW YORK

Telephone: 2726 BROAD.

Cable Address: "LAGERLÖF NEWYORK."

# Scandinavian-American Trading Company,

PRODUCE EXCHANGE BUILDING, NEW YORK,

IMPORTERS AND EXPORTERS OF

FOREIGN AND DOMESTIC

# WOOD PULP

OF ALL KINDS

AND

# PAPER MILL SUPPLIES.

HANS LAGERLÖF, PRES.



# CROOKES, ROBERTS & CO.

SHEFFIELD ENGLAND

Makers of

Crucible Cast Steel  
 Bed Plates  
 Jordan Fillings  
 Beater Bars



Makers of

Bessemer Cast Steel  
 Crookes' Composition  
 Fillings

And every description of Cutter Knives, Tools and Steel used and required in Paper Mills.

**ARGUS** High-Speed **STEEL** for fine machine tools is unsurpassed.

Once Used - Always Used

YOU SAVE MONEY USING "ARGUS" GOODS

WRITE US

**ARTHUR P. TIPPET & CO.**

Agents for Canada

MONTREAL

# SPENCER'S

ALWAYS



RELIABLE

Best Wool - Best Weave - Best Wear

**J. H. SPENCER & SONS**

BURY ENGLAND

Canadian Agents: **ARTHUR P. TIPPET & CO., MONTREAL**

# INDEX TO ADVERTISEMENTS.

(SEE CLASSIFIED ADVERTISERS INDEX ON PAGE XXVI.)

Ambursen Hydraulic Construction Co. ....lxv  
 Anderson, F. C. ....lviii  
 Appleton Machine Co. ....vi  
 Atterbury Bros. Inc. ....lxii  
 Baker & Shevlin Co. ....vii  
 Becker & Co. ....xxix  
 Beloit Iron Works. ....xiii  
 Bentley & Jackson. ....viii  
 Bertram, James & Son, Ltd. ....xix  
 Bertram's, Limited. ....xlx  
 Black-Clawson Co., The. ....xlxiii  
 Blethen, Hugh R. ....lix  
 Bredt & Co., F. ....li  
 Brunner, Mond & Co., Limited. ....lxvi  
 Canada Coating Mills, Limited. ....lvii  
 Canada Paper Co., Ltd. ....lvii  
 Canadian Boomer & Boschert Press Co. ....lx  
 Canadian Boving Co. ....lxiii  
 Carthage Machine Co. ....xxiv  
 Castle, Gotthel & Overton. ....li  
 Chicoutimi Pulp Co. ....xxxii  
 China Clay Co. ....i  
 Christie, J. Co. ....lxvi  
 Christie, Limited, George. ....lxv  
 Crookes, Roberts & Co. ....xlvi  
 Crossley, T. L. ....lviii  
 Dallyn, Jardine & Co. ....li  
 Dayton Globe Iron Works, Co., ....xxx  
 Dean, F. W. ....lviii  
 DeCew, J. A. ....lix  
 Dillon Machine Co. ....xiv  
 Dobler & Mudge. ....vi  
 Dodge Mfg. Co. ....iv  
 Dominion Belting Co. ....xlxiii  
 Eaton & Brownell. ....lviii  
 Eastern Pipe and Construction Co., The. ....i

Emerson Mfg. Co. ....xxvi  
 Farrel Foundry and Machine Co. ....xxxvii  
 Fibre Development Co., The. ....lviii  
 Finckh, Hermann. ....xxxiii  
 Garland, M. Co. ....xii  
 General Supply Co. of Canada, Ltd. ....lv  
 Gewerkschaft Sachtleben. ....xl  
 Gillespie, Geo. H. Co. ....lxv  
 Glens Falls Machine Works. ....iv  
 Green Bay Barker Co. ....xxi  
 Hamelin, The, & Ayers Co., Ltd. ....lx  
 Hardy, Geo. F. ....lviii  
 Harmon Machine Co. ....v  
 Hay Knife Co., Peter, Limited. ....lxi  
 Holyoke Machine Co. ....xvi  
 Hooker Electrochemical Co. ....xliv  
 Hough, R. ....lxvi  
 Howell Co., The. ....xlxviii  
 International Process Co. ....lii  
 Jeffrey Mfg. Co. ....liii  
 Jenckes Machine Co. ....lvii  
 Johnson & Sons, Limited, C. H. ....xlx  
 Jones, E. D. & Sons Co. ....liv  
 Kimball, Herbert S. ....lix  
 Klipstein & Co., A. ....i  
 Lawrence Pump & Engine Co. ....li  
 Lea, R. S. & H. S. Ferguson. ....lviii  
 Little, Arthur D. Inc. ....lviii  
 Lyford, C. A. & Co. ....lviii  
 Mallandain, Albert E. ....xxxiii  
 Marx, J. & Co. ....v  
 Mardon, Alfred H. ....lx  
 McDougall, John, Caledonian Iron Works  
 Co., Limited. ....liii  
 Milne, Jas., and Son. ....xx  
 Moore & White Co. ....xv

## HYDRAULIC TURBINES

One unit of six with a total capacity of 13,100 Horse Power furnished for the new plant of J. R. Booth, Ottawa, Ontario. We build Turbines for any power for heads from 3 to 600 feet.

WRITE FOR CATALOGUE



**S. MORGAN SMITH CO.,**  
 YORK - PA.

New Brunswick Pulp and Paper Co., Limited.....lvi  
 Northern Engineering Works.....lxvi  
 Northern Mills Co.....lvi  
 Panzl Digester Lining Co.....lvi  
 Paper Makers Chemical Co.....lxi  
 Parsons Trading Co.....xxiv  
 Penman's Limited.....li  
 Perkins, B. F. & Son.....xxxv  
 Phillips, S. C. & Co.....xxxviii  
 Porritt & Son, Joseph.....ii  
 Porritt Bros. & Austin.....xlx  
 Prather, H. B.....lix  
 Preston's Digester Lining Co., Limited.....xxxiv  
 Pringle, T. & Sons.....lviii  
 Pullan, E.....liiv  
 Pulp & Paper Trading Co., The.....lxi  
 Reddaway, F. & Co.....liiv  
 Rice, Barton & Fales.....ii  
 Riordon Paper Co., Limited.....lvii  
 Ryther & Pringle.....xxxv  
 Sadler & Haworth.....xxxii  
 Sandy Hill Iron & Brass Works.....xvii  
 Scandinavian American Trading Co.....xli  
 Scott, Ernest & Co.....xli  
 Sherbrooke Machinery Co., Limited.....xviii  
 Smart-Turner Machine Co.....lxvii  
 Smith, S. Morgan, Co.....xvii

Snell, Samuel Co.....l  
 Spencer, J. H. & Sons.....xlvi  
 Stebbins Engineering & Mfg. Co.....lix  
 Sweezey, R. O.....lix  
 Swenson Evaporator Co.....xli  
 Taylor, J. A.....lxvii  
 Ticonderoga Machine Works.....xxvii  
 Tippet, Arthur & Co.....xxvii-xlvi  
 Union Screen Plate Co.....iii  
 Union Sulphur Co., The.....lxi  
 United Wire Works, Limited.....xxvii  
 Valley Iron Works.....xxxvi  
 Vera Chemical Co.....lxii  
 Voith, J. M.....x  
 Walker, J. R. & Co.....lxii  
 Wallace, Jos. H. & Co.....lix  
 Walmsley, Charles & Co.....xxii-xxiii  
 Wandel, Chr.....xlii  
 Wandel Screen Mfg. Co.....ix  
 Waterous Engine Works Co., Limited.....lxiv  
 Wertheim & Co., A.....lxiii  
 Westbye, P. P.....xi-xxxiii  
 West End Engine Works Co.....xxvi  
 Wilson, Paterson & Co.....xxv  
 Winn & Holland.....lxvi  
 Woolford, G. Wood Tank Mfg. Co.....lxii  
 Zaremba Co.....liv

**KRAFT PULP**



The best Pulp for making

**KRAFT BROWN PAPER**

Sole Selling Agents, United States  
and Canada

**THE HOWELL CO.**

8-10 Wellington St., East

**TORONTO - CAN.**

**MAPLE LEAF**  
**STITCHED COTTON DUCK**  
**BELTING**  
**DOMINION BELTING CO. LTD.**  
**HAMILTON CANADA**

**HAVE YOU GOT YOUR COPY OF THE  
 PAPER MAKERS' POCKET BOOK?  
 SEE PAGE LIV.**

You can Purchase  
Thoroughly Up-to-date  
**Paper Mill Machinery**  
and the Strongest Type of  
**FAST-RUNNING PAPER**  
**MAKING MACHINES**

FROM

**Bertrams Limited**  
SCIENNES  
EDINBURGH

**C. H. JOHNSON & SONS, Ltd.**

WIRE WORKS, ST. HENRY, MONTREAL.

MANUFACTURERS OF

**Fourdrinier Wires, Cylinder Wires,  
Brass, Copper and Iron Wire Cloth, Dandy Rolls**

**PORRITT BROS. & AUSTIN**

Stubbins Vale Mills—RAMSBOTTOM—near Manchester, England

Manufacturers of every description of

**FELTS AND JACKETS FOR  
PULP AND PAPER MILLS**

Agents for Canada: C. H. JOHNSON & SONS, Ltd., ST. HENRY, MONTREAL

**We Manufacture** Wooden Water Pipe for Water Works Systems. Specially  
 Made Pipe for conveying Chemicals. Continuous Stave  
 Pipe for Power Plants. Sizes from 2" to 12' Diameter

**The Eastern Pipe and Construction Co.,**  
 Alexandria, Box 329 Ontario.

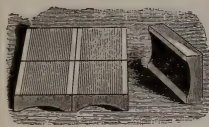

### Use Snell's Drainer Bottoms

They drain quickly and don't let the Pulp go into  
 River. **No Dust. No Splinters. Clean Stock.**  
*Send for Sample and Price.*

**Samuel Snell Co., - Holyoke, Mass.**

Cable Address:—"Kaolin, Manchester." A.B.C. Codes 4th & 5th Edition

# CHINA CLAY CO.

JOHN WILLIAMSON, Manager.

4 St. Anne's Square

**MANCHESTER, ENG.**

MINES—Ruddle, Bojea, Colchester, South Ninestones, Tronance, St. Austen  
 Cornwall.

CONTRACTORS TO H.M. INDIAN GOVERNMENT

Canadian Representatives—C. A. Meincke & Co., 222 Coristine Bldg., Montreal.

## A. KLIPSTEIN & Co. Ltd.

(OF CANADA)

12 ST. PETER ST.

MONTREAL

# SULPHATE ALUMINA

CHINA CLAY, BLEACH and CASEIN  
 PAPER BLUE, both Basic and Acid  
 AURAMINE - RHODAMINE

and all other Aniline Colors

Shades Carefully Matched in our Laboratory Mention Pulp & Paper Magazine

New York Office - 129 Pearl Street



**LAWRENCE PUMP  
AND ENGINE CO.**

P.O. BOX 70, DEPT. 10  
LAWRENCE :: MASS.

**CENTRIFUGAL PUMPS**

We make an exclusive specialty of High Efficiency Centrifugal Pumps for Paper and Pulp Mill. In one mill 49 of our Pumps are running, the customer writes—"Your Pumps are all giving perfect satisfaction."

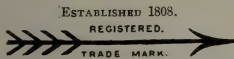
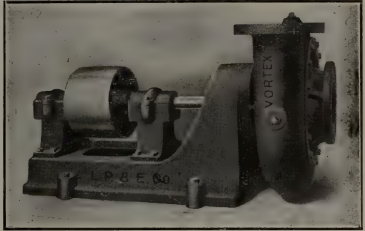

**FELTS** For Pulp and Paper Mills.

**JOSEPH PORRITT & SONS**

Agents for  
Canada  
and United  
States.

**HELMSHORE**

Manchester, England.

All kinds  
Woollen, Lin-  
en and Cotton  
Cloths for  
Mechanical  
Purposes.

**F. BREDT & CO., 240 Water Street, NEW YORK.**

**PENMANS LIMITED**  
**ST. HYACINTHE, QUEBEC**

Manufacturers of  
**PULP AND PAPER MAKERS' FELTS,  
JACKETS, STRAINER CLOTHS, ETC.**

Special sizes and qualities made to order. Satisfaction guaranteed.  
**DALYN, JARDINE & CO. TORONTO Selling Agents**

**CASTLE, GOTTHEIL & OVERTON**

*200 Fifth Avenue, New York*

AGENTS FOR

***Sulphite and Wood Pulp Mills***

Dealers in all kinds of Paperstock, Sizing, etc.

Correspondence Solicited.

THE PROCESSES AND APPARATUS  
THAT MADE "KRAFT PAPERS" SUCCESSFUL



CABLE ADDRESSES  
KRAFTLICH, NEW YORK.  
INPROKRAFT, LONDON.

# INTERNATIONAL PAPER CO.

AMERICAN OFFICES  
5 BEEKMAN STREET  
NEW YORK, N.Y.

SOLE AGENTS IN NORTH AMERICA  
FOR  
CARL P. CARLSON, SWEDEN.  
EVAPORATORS AND LIQUOR SYSTEMS.

JULIUS PINTSCH, ACTIENGESELLSCHAFT, GERMANY.  
DIGESTERS, DIFFUSERS AND SPECIALTIES.

SWEDISH SYSTEM OF RECOVERY FOR  
TURPENTINE, ALCOHOL AND OTHER BY-PRODUCTS.

EUROPEAN OFFICES  
SALISBURY HOUSE,  
LONDON, ENGLAND.

ENGINEERS, CHEMISTS, PULP EXPERTS.

# Twelve Units of New American Turbines

Comprising 60—34 inch wheels now being installed by the Lake Superior Paper Co., Ltd., Sault Ste. Marie, Ontario. Each unit develops

1,000 H.P.

210 R.P.M.

under 18 ft. head,

Driving two Pulp

Grinders Direct

Connected.

The accompanying illustration shows one of these units as it was assembled in our factory.

If interested send for Catalog 27

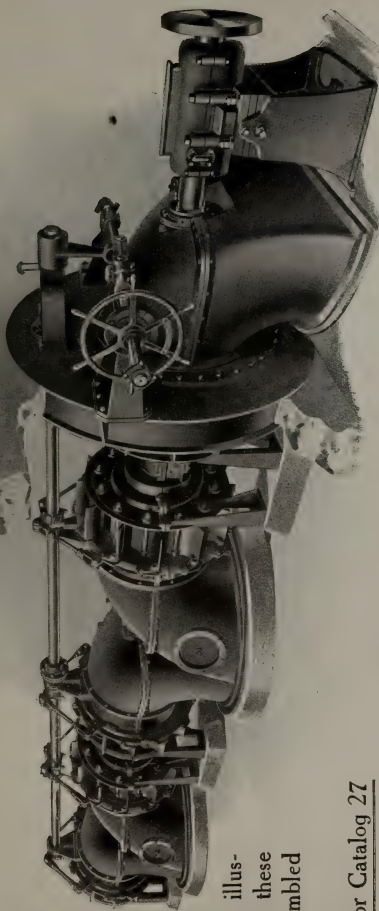

THE

# Dayton Globe Iron Works Co., Dayton, Ohio, U.S.A.

Nearly FIFTY YEARS ago we introduced this Belt. IT HAS STOOD THE TEST OF TIME

2" to 24" in stock

Every Belt is  
Stamped with  
Trade-Mark.



Write or phone us

Beware  
of Imitations

SOLE MAKERS

F. REDDAWAY & CO.,

MONTREAL, CANADA.

**E. PULLAN,** 490 Adelaide St. W.,  
TORONTO

Largest Paper Stock Dealer in Canada

**RAGS AND PAPER STOCK GRADED TO SUIT MILL REQUIREMENTS**

Correspondence Solicited.

Edward A. Jones, President and Treasurer.

Wallace E. Bardwell, Secretary

**F. D. JONES & SONS CO.,** Pittsfield, Mass.

Manufacturers of

**PAPER MAKING MACHINERY  
AND MECHANICAL ENGINEERS**

Beating Engines. Washing Engines. Mixing Engines. Bleaching Engines.  
Cooking Engines. Vertical and Horizontal Stuff Chests.

Jordan Engines of three sizes, either belt or direct-connected motor-driven ;  
fillings of Wagg Steel or stone type, three-part or plain.  
Dusting Machinery of all kinds.

SECOND AND ENLARGED EDITION

# THE PAPERMAKERS' POCKET BOOK

Specially Compiled for

PAPER MILL OPERATIVES, ENGINEERS, CHEMISTS,  
AND OFFICIALS

By JAMES BEVERIDGE

- ☞ This new edition contains more exhaustive chapters on Raw Fibrous Stock, such as Cotton and Linen Rags, Esparto, Bamboo, Megass or Crushed Sugar Cane, etc.
- ☞ The chapter on Wood Cellulose Manufacture by the Soda, Sulphate, and Sulphite methods has been amplified. Very complete information has been given of Soda Recovery, Causticising and Composition of Recovered Soda Liquors.
- ☞ A new but brief chapter has been added relating to Loading Materials.
- ☞ The chapter on Chemical Analysis has been enlarged.
- ☞ It will be found that the additional matter is given in concise form, is of a highly practical nature, and is not generally found in English text books.

PRICE, \$3.50

**BIGGAR-WILSON, LTD., TORONTO**

# VI-BALATA BELTING

Is made in all widths up to 50 inches, and in any thickness from 3 ply to 24 ply. Is absolutely waterproof and not affected by extremes of temperature. Has great strength and durability, and is practically stretchless.

A recent test made by the well-known Testing Engineers, Messrs. Kirkaldy & Sons, London, Eng., gives the following result:

**6-inch 4-ply broke at 13,000 lbs.**

OR

**9,000 lbs. per square inch**

**LARGE STOCKS CARRIED AT ALL BRANCHES**

---

---

SOLE AGENTS:

**THE GENERAL SUPPLY CO.,**  
OF CANADA, LTD.

**356-58-60 SPARKS ST., - OTTAWA, ONT.**

115-125 Adelaide Street West, **TORONTO**

**WOODS WESTERN BUILDING, Cor. Market & Louise Sts., WINNIPEG, MAN.**

**FLECK BROS., LTD., 443 Pender St. West, VANCOUVER, B.C.**



## THE NORTHERN MILLS COMPANY

**Paper Manufacturers. Printing and Writing Papers.**

Super-Calendered, Velvet and Machine Finished Book, Litho and Antique Printing, Engine Sized Writing and Envelope Papers, White and Tinted Bond. Typewriter Papers (Glazed and Rough Finish). Writing Tablets and Envelopes.

Ask for "Canadian Bond," "Provincial Bond," "Adelia," and "Northern Mills."

**Head Office:**

**Montreal, 278 St. Paul Street.**

**Mills:**

**St. Adele, Que.**

## Genuine "KRAFT" Papers MADE IN CANADA

**THE NEW BRUNSWICK PULP & PAPER CO., LTD.**

**Springfield Mills, Millerton, N.B.**

**TORONTO, 145 Wellington St. W.**

**MONTREAL, 404 St. Nicholas Bldg.**

## PANZL'S PATENTED LINING COMPOSITION

IS THE SAFEST AND BEST MATERIAL FOR

**LINING OF SULPHITE PULP DIGESTERS**

AND ACID RECLAIMING TANKS

**PANZL LININGS ARE SAFEST AND  
MOST DURABLE**

They are really acid-proof and practically indestructible.

All Digesters lined with Panzl's patented composition, now as tight and in as good condition after years of continuous use as they ever were, no leaks and no repairs.

Panzl Linings can be made considerably thinner than the other linings, thus increasing the capacity of the digesters.

The composition and the system of constructing of Panzl Linings are patented in all countries where wood pulp is being manufactured by the sulphite process. The PANZL U.S. Patents have been adjudicated to be valid in law and wholly independent of all prior patents relating to linings of digesters.

For information and estimates, address:—

**PANZL DIGESTER LINING COMPANY**

**505 Washington Ave., Muskegon, Mich.**

## The Riordon Paper Company, Limited

Fibre, Paper, Lumber.

MONTREAL - CANADA

News Paper, Hanging Paper, Wrapping Paper, Building Paper,  
Celebrated "Impervious" Spruce Sheathing and Sulphite Fibre for all  
kinds of Paper.

## THE CANADA COATING MILLS, Ltd.

GEORGETOWN, ONT.



Manufacturers of  
SURFACE COATED BOOK and LITHOGRAPHIC  
PAPERS COATED CARDBOARD and COATED  
BOXBOARDS of every description.

### "Chalk White" Coated Book Paper.

The best and whitest coated paper sold.

**ALL REGULAR SIZES AND WEIGHTS IN STOCK.**

Our Art Litho Cover Paper is stocked in four tints,  
2 sizes. 20x25 and 21½x28½. Samples gladly sent.

MONTREAL  
TORONTO

**CANADA PAPER CO.**  
LIMITED

WINDSOR  
MILLS, P.O.

# DIRECTORY

of

## Civil and Chemical Engineers

### T. PRINGLE & SON, Limited

Engineers and Architects

Plans and Specifications for Pulp and Paper Mills, Power Plants and other Industrial Works.  
**Coristine Bldg., Montreal.**      **Continental Life Bldg., Toronto.**  
 Bell Tel.: M. 3890.      Tel.: M. 5917.

### R. S. LEA, and H. S. FERGUSON, ENGINEERS

Pulp, Paper and Chemical Fibre Mills.  
 Water Power Development and Transmission. Steam Power Plants.  
**Telephone Long Distance Up, 751.**  
 405 DORCHESTER ST. West, MONTREAL

### Arthur D. Little Inc.

— LABORATORY OF —  
 ENGINEERING CHEMISTRY  
 93 BROAD ST., BOSTON, - MASS.

Our staff includes experts in Papermaking Chemistry  
 —Sulphite Mill Practice—Fuel Engineering.

### GEORGE F. HARDY, M. AM. SOC., M. E. M. CAN. SOC. C. E.

Consulting Engineer.

Paper, Pulp and Fibre Mills, Examination of Mill Properties, Water Power Developments.  
**Mutual Reserve Building, - 309 Broadway, NEW YORK.**

CHARLES E. EATON,      JAMES P. BROWNELL,  
 M. Am. Soc., M. E.      C. E.

### EATON & BROWNELL, Consulting Engineers and Architects.

Paper, Pulp and Fiber Mills, Water, Steam and Electric Power Development, Examination of Properties, Consultation Reports.  
 SMITH BLDG.      WATERTOWN, N. Y.

### F. W. DEAN, Mill Engineer and Architect

(Formerly of Dean & Main)

**Exchange Building 53 State Street,  
BOSTON, Mass.**

Paper and Pulp Mills. Steam, Hydraulic and Electrical Developments. Examinations and Reports of Projects.

### T. LINSEY CROSSLEY

*Engineering Chemist*

PULP AND PAPER  
TECHNOLOGY

318 LaGauchetiere St., W., Montreal

### THE FIBRE DEVELOPMENT CO. APPLETON, WIS., U.S.A.

*Engineers*

WATER POWERS      STEAM AND ELECTRIC PLANTS  
 PULP AND PAPER MILLS.

### FRED. C. ANDERSON

*Mill Engineer*

20 years practical experience in paper, ground wood and chemical pulp making. Steam Hydraulic and Electrical development, Examinations and Reports on both old properties and new projects.

9-10 Strickland Bldg., CARTHAGE, N. Y.

### FOREST ENGINEERS

FOREST SURVEYS      LOGGING MAPS

WATER POWER      TIMBER ESTIMATES      WATER STORAGE

**CLARK, LYFORD & STERLING**  
 1331 Real Estate Trust Bldg., Philadelphia  
**CLARK & LYFORD**      **LYFORD, CLARK & LYFORD**  
 403 Crown Bldg.      206 Board of Trade Bldg.  
 Vancouver.      Montreal.

**PULP** JOSEPH H. WALLACE & CO.  
**PAPER** INDUSTRIAL ENGINEERS.  
**OWER** TEMPLE COURT BLDG. NEW YORK.  
 SALISBURY HOUSE, LONDON, E.C.  
 CABLES, TRIPLEX, N. Y., TRIPLEX IS, LONDON.

**J. A. De CEW**

M.A. INST. CHEM. ENG.  
 A.M. CAN. SOC. C.E.

Paper Mill Analysis.

Sulphite Fibre

Pulp Testing

*Chemical  
 Engineer*

Soda Fibre

Investigations.

Reports

**Canadian Express Building MONTREAL.**

HERBERT S. KIMBALL, S.B., M. Am. Soc. C.E.  
 Chemical Engineer and Mill Architect.

R. O. SWEEZEY, B.Sc., A.M. Can. Soc. C.E.  
 Civil and Forestry Engineer.

**Chemical and Mechanical Pulp & Paper Mill Engineers**

Canadian Timber Lands and Waterpower Development  
 Consultations solicited on Canadian exploitation.

**Metropolitan Building, QUEBEC, Canada.**

Power, Lighting, Heating, Ventilating and Drying.—Complete New Plants, Improvement of Old Plants;  
 Plans, Specifications, Contracts, Estimates, Tests, Appraisals, Inspections and Reports.—Pulp, Paper,  
 Box Board and Coating Mills.

Lowest

**H. B. PRATHER,**

Guaranteed

Possible

*CONSULTING ENGINEER,*

Results.

Operating Cost. **ROCKFELLER BLDG., CLEVELAND, O.**

**HUGH R. BLETHEN**

**21 PARK ROW, - - - NEW YORK, N.Y.**

Traveling Cranes - Overhead Tramways - Trolleys and Chain

Hoists for Paper and Pulp Mills - Power Houses.

**Stebbins Engineering & Mfg. Co.**

**WATERTOWN, N.Y.**

MANUFACTURERS OF

STEBBINS' ACID SYSTEMS, SULPHUR BURNER

DIGESTER LININGS, RECLAIMERS, ETC.

Engineering Department  
 under

Plans, Estimates and Specifications for Paper,  
 Pulp and Fibre Mills,

Mr. T. L. TOMLINES

Water Power and Hydro-Electric Developments

## LEUNIG PAPER SCALES

Showing correctly at a glance, by weighing a single sheet, the weight of a ream of Paper of any size, containing either 480, 500, or 516 sheets.

Can also be made to indicate in addition to the English weight, the weight in Kilogrammes.

Illustrated Price List on Application.

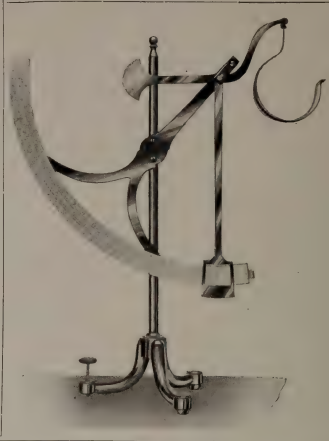

$\frac{1}{2}$  to 80 lbs.

**Price,**  
**Ten Dollars**  
F.O.B., London

$\frac{1}{2}$  to 120 lbs.

**Price,**  
**Fourteen Dollars**  
F.O.B., London

Illustrated Price List on Application.

**Alfred H. Mardon** 150 Shaftesbury Ave. **London, Eng.**

## PULP PRESSES

AND ACCESSORIES

**CANADIAN BOOMER & BOSCHERT PRESS Co., Ltd.**

18 TANSLEY STREET, MONTREAL

" LACHUTE FELTS "

Bell Tel. No. 23

**The Hamelin & Ayers Co., Limited**

LACHUTE MILLS, P.Q.

MANUFACTURERS OF EVERY DESCRIPTION OF

**FELTS** FOR PAPER AND PULP MILLS

"The Best are the Cheapest."



**BARKER  
CHIPPER  
PAPER-CUTTER**

**MACHINE** *Of Every*  
**KNIVES** *Description*

**THE PETER HAY KNIFE CO., LIMITED, GALT, ONT.**

**The PULP & PAPER TRADING CO.**

TEMPLE COURT BUILDING, NEW YORK CITY.  
DEALERS IN

**Paper and Pulp of All Kinds.**

Prices and Samples on Application.

REGISTERED



JOHN KNIGHT, Pres. C. K. WILLIAMS, Treas. C. H. KNIGHT, Sec.

**Paper-Makers Chemical Co.**

FROM MINE TO MILL

**ENGLISH CHINA CLAYS  
MANUFACTURERS**

**Excelsior Felt Cleaner**

GBB Brand China Clay is  
a natural pure white, no artificial tinting Superior Rosin Size  
Unsurpassed for Superior Casein Size  
coating, bleaching, or fine papers.

**EASTON, PA., U.S.A.**

# **The Union Sulphur Company**

**Producers of the Highest Grade Brimstone on the Market**

Absolutely free from Arsenic, Selenium or Tellurium

**The Largest Sulphur Mine in the World**

**CALCASIEU PARISH, - LOUISIANA**

**Main Offices : Whitehall Bldg., 17 Battery Place**

**NEW YORK**

## WE GUARANTEE OUR SIZINGS TO BE ABSOLUTELY CLEAN OUR VERA PAPER SIZE

is purest, strongest and highest free rosin size made. We can furnish you with an ideal rosin size and patented apparatus to use same.

### OUR VERA MILL SIZE

is the best soluble paper makers' rosin size made. Ready to use in cold or warm water in the ordinary way without apparatus. Gives better satisfaction and is more economical than mill made size.

Our sizings are cleaned by our new patented process, and we guarantee this size to be absolutely clean, without the least speck of impurity in the same, preventing thereby black specks in the paper. We are shipping our size in barrels or tank-cars.

## VERA CHEMICAL COMPANY

Main Office and Western Factory  
NORTH MILWAUKEE, WIS.

Eastern Factory  
STONEHAM, MASS.

**J. R. Walker & Co.** Importers and Packers of **GRADED RAGS, PAPER STOCK  
ROPE BAGGING, ETC.**

WAREHOUSE, 35 COMMON ST., MONTREAL.

Also Manufacturers of Roofing and Building Papers. Leatherboard and Friction Board

Mills at Sault au Recollet, P.Q.

**ATTERBURY BROTHERS, Incorporated.**

*Importers and Exporters.*

**Wood Pulp, FOREIGN AND DOMESTIC Rags AND Paper Stock**

Potter Building, 145 Nassau Street, New York City.

Cable address "AFFECTIVE," New York.

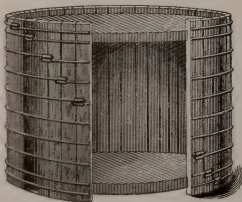

# WOOD TANKS

FOR PAPER MILLS,  
STUFF CHESTS,  
ACID TANKS,  
BLOW TANKS.

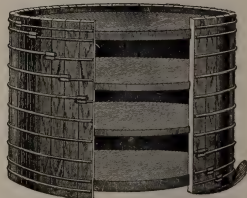

G. WOOLFORD WOOD TANK MFG. CO., 1429 CHESTNUT ST. PHILADELPHIA, PA.

# A. WERTHEIM & Co.

## HAMBURG

---

---

IMPORT AND EXPORT ALL KINDS OF

***Sulphite,  
Soda and  
Mechanical***

# WOOD PULPS

---

---

### **OFFICES AT:**

CHRISTIANIA (Norway) .. Kirkegaden No. 20.  
GOTHENBURG (Sweden) .. Lilla Kyrkogatan No. 20.  
MANCHESTER .. .. Guardian Buildings (opposite Exchange).  
LONDON .. .. 77a Queen Victoria Street, E.C.  
PARIS .. .. Rue de Londres No. 29.  
ANGOULEME (France) .. 43 Rue Louis Desbrandes.  
LYONS .. .. 54 Cours Gambetta.  
MILAN .. .. 24 Via Solferino  
TOLOSA (Spain) .. .. 18 Calle San Francisco.  
NEW YORK .. .. 99 Nassau Street.  
ST. PETERSBURG .. .. Little Podjascheskaja House, 4, Qu. 16.

---

---

**Telegraphic Address :**

**“WERTHEMO, HAMBURG.”**

*Over 70 sold since April, 1911*

When it comes right down to brass tacks, orders, and particularly *repeat* orders, are the best indication of the quality of a machine.

## Quiller Centrifugal Screens

have been manufactured by us in Canada only since last spring. Already some 70 of the machines have been placed and we are busy filling the repeat orders our earlier installations have brought in.

**The Quiller Screen** has been tried out for many years in European mills. Of late years numerous installations have been made in the United States and Canada. Not only has it demonstrated its complete adaptability to American conditions but it has been acknowledged without superior in screening capacity and in economy of operation.

### **With Proved Maximum Capacity.**

Horizontal Type—12 to 14 tons Ground Pulp.

Vertical Type—12 tons Ground, 15 tons Sulphite Pulp.

### **Guaranteed Minimum Power Consumption.**

3/4 H.P. per ton capacity.

*Write us for full information and let us refer you to an installation in your neighborhood.*

**The Waterous Engine Works Co.,**  
Limited  
Brantford, Canada.

**Geo. Christie Ltd.** - - **Glasgow  
Scotland**

## **FOURDRINIER MACHINE WIRES**

Unequalled for Strength, Smoothness and Long Life

## **CYLINDER COVERS**

**Canadian Agent :**

**J. A. Taylor, 22 St. Francois Xavier St., Montreal**

## **CANADIAN TALC FILLER**

**GEO. H. GILLESPIE COMPANY**

**MADOC - - - ONTARIO**

*The only Manufacturers of Paper Filler in Canada.*

Our Filler is used in Canada, United States, England, Germany,  
Austria, Holland, Russia and Scandinavia.

## **AMBURSEN HYDRAULIC CONSTRUCTION CO.,**

**OF CANADA, LIMITED,**

**405 Dorchester St. W. - Montreal.**

(Associated with the Ambursen Hydraulic Construction Co., of Boston, Mass.)



### **Concrete Steel Dam**

OF THE

**MISSISQUOI PULP CO.,**

**Sheldon Springs, Vt.**

Mid-channel, height 40 feet  
Total length 270 feet (only  
180 feet shows in the pic-  
ture, the remainder being  
concealed at the left.)

Dam specially designed to  
withstand heavy ice gorges.  
Factors of safety are calcu-  
lated for a 12-foot flood.

**IF YOU HAVE A DAM TO BUILD, WRITE US NOW.**



Every Grade of Waste for  
Paper Making.

# R. HOUGH,

LONDON, England.

Agent for Canada and U. S.,

**THE J. CHRISTIE CO.**

5 King St. West, TORONTO, Canada.

STEAM PUMPS  
CONDENSERS  
VACUUM PUMPS  
TRIPLEX POWER PUMPS  
CENTRIFUGAL PUMPS

The Smart-Turner  
Machine Co., Limited

HAMILTON

CANADA

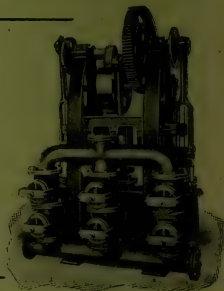

**Cranes and Hoists for Paper Mills and Power Plants**



155



121c



156

NORTHERN ENGINEERING WORKS, 25 Chene Street - DETROIT, Mich.  
ADVANCE MACHINE WORKS, LTD., Manufacturers for Canada, Walkerville.

# WINN & HOLLAND, Limited

MONTREAL

PULP AND PAPER CHEMICALS. Sole Agents for:

**BRUNNER, MOND & CO'S.**

SODA ASH,

BLEACHING POWDER,

SAL SODA,

CAUSTIC SODA, &c.

# PULP AND PAPER MAGAZINE OF CANADA

VOL. 17 TORONTO, APRIL, 1912, No. 4.

## PRINCIPAL CONTENTS

- Experimental Pulp & Paper Laboratory.
- Forest Wealth of Northern Ontario.
- United States and Favored Nation Treaties.
- Argentine Paper Trade.
- Pulp and Paper Consumption for Canada in 1910.
- Treatment of Lignin-Yielding Materials.
- Alum for Stains.
- Coaling Rolls on Paper Machines.

Established 1837

Incorporated 1867

# RICE, BARTON & FALES

## MACHINE & IRON CO.

CHARLES S. BARTON, Pres. & Treas.  
 GEORGE S. BARTON, Secretary.

WORCESTER, MASS.

BUILDERS OF

**Modern Fast Running and Heavy Four-  
 drinier and Cylinder Machines for Making  
 Paper, and Drying Pulp.**

Double Drum Vertical Winders and Re-Winders.

Upright and Revolving Reels.

Large and Heavy Wet Machines.

Revolving Cutters and Layboys.

Hill Patent Diagonal Cutters, which can be equipped with  
 Slitting Arrangement, and Reeling Off Bars.

Chilled Iron Calender Rolls.

Screens and Screen Plates.

Stuff, Suction and Fan Pumps.

Patent Top and Double Edged Slitters.

Pneumatic Re-Winders for Small Rolls.

Additions and Changes made to Old Paper Machines  
 Greatly Increasing Speed and Capacity.

## Sulphite Mill Specialties



Wherever material has to be handled in Pulp and Paper Mills, Jeffrey Conveying Equipments provide the most economical and efficient means. Designed and built to meet every practical requirement.

We also manufacture Elevators, Pulp Lap Shredders, Power Transmission Machinery, Industrial Locomotives, Log Haul Ups, etc.

SEND FOR LATEST CATALOGS.

## The Jeffrey Manufacturing Company

Canadian Main Office and Works—  
MONTREAL. 3-15-12

WINNIPEG OFFICE—  
141 Bannatyne Ave.

E. J. WELCH, *President and Managing Director*  
HENRY W. S. DOWNS, *Superintendent*

EMMONS CROCKER, *Vice-President*  
A. S. MORSE, *Secretary and Treasurer*

# SCREEN PLATES



The "Union" Bronze (best phosphorized cast metal) Plates for Sulphite Mills. The Standard Rolled Brass Plates. The "Union" Cast Metal Suction Plates.

We carry a large stock of blanks of the various sizes in both metals and can fill all orders promptly.

Old plates reclosed and recut by our process are practically as good as new and give better results than by any other process.

## Union Screen Plate Co. of Canada, Limited

FACTORY : LENNOXVILLE, QUEBEC.

OFFICES : Lennoxville, Quebec, and Fitchburg, Massachusetts, U. S. A.

# Glens Falls Machine Works

GLENS FALLS, N.Y.



Sole Manufacturers of  
**Tromblee & Paull Rotary Sulphur Burner**  
**The Moore Rotary Screen**  
**The Reynolds Screen**

Also Manufacture

**Cedar Point Foundry Grinders**  
**Improved Standard Grinders**  
**Improved Wet Machines**  
**Rotary Pumps, etc.**

Write for Particulars and Specifications—they are free.

# DODGE

## Transmission

## Machinery

High Grade Only

**Shafting, Hangers, Pulleys,**  
**Friction Clutch Pulleys.**

## DODGE MANUFACTURING CO.

640 ST. PAUL ST. HAYMARKET SQUARE MONTREAL LIMITED



**J. Marx & Co., - - London, E.C., England**

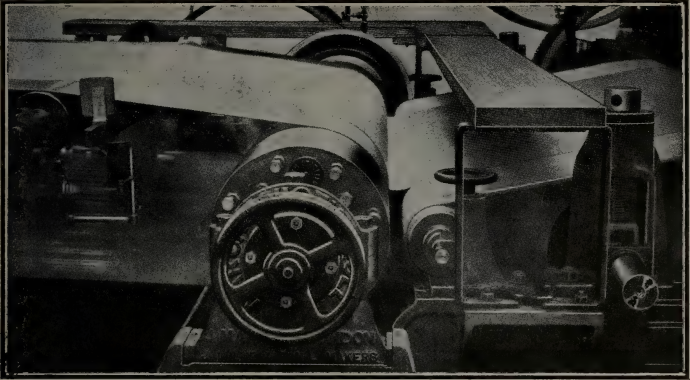

MARGALT SUCTION ROLL AT WORK

**SPECIALITIES** Basalt Lava Stone Beater Rolls, Double Beaters, Stone  
Wet Press Rolls, Basalt Lava Pulp Refiners for Screenings.

Canadian  
Representative

**Judson A. DeCew**

Canadian Express  
Building

**Montreal**

*The*

## Harmon Incline Screening System

Will give greatest capacity.

Will give cleaner stock.

Will save power.

Will save labor.

Does not require use of Rakers.

Write us for full descriptive Catalogue and testimonials from the best mills in the country.

# HARMON MACHINE COMPANY

WATERTOWN, N. Y., U. S. A.

## THE EDDY PAPER TESTER

Will register the breaking strength of paper in pounds per square inch—a recognized standard the world over.

**\$15.00 net**  
postpaid.

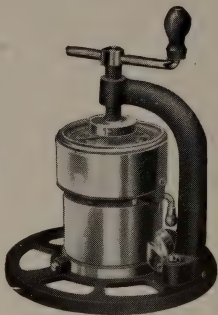

Is provided with an adjustment whereby the user can reset same, if necessary. Will do the work of higher priced machines and do it quicker. 6 inches high.

### DOBLER & MUDGE

BALTIMORE, MD., U.S.A.

— THE BEST —  
**JORDON ENGINE**  
IS BUILT BY THE

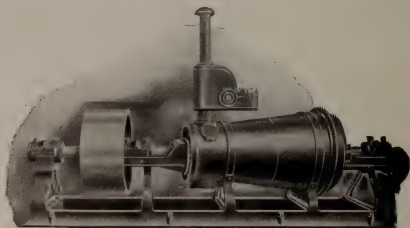

### APPLETON MACHINE CO.

APPLETON, WIS.

SEND FOR PARTICULARS

THE SANDY HILL IRON AND BRASS WORKS, HUDSON FALLS, N.Y.

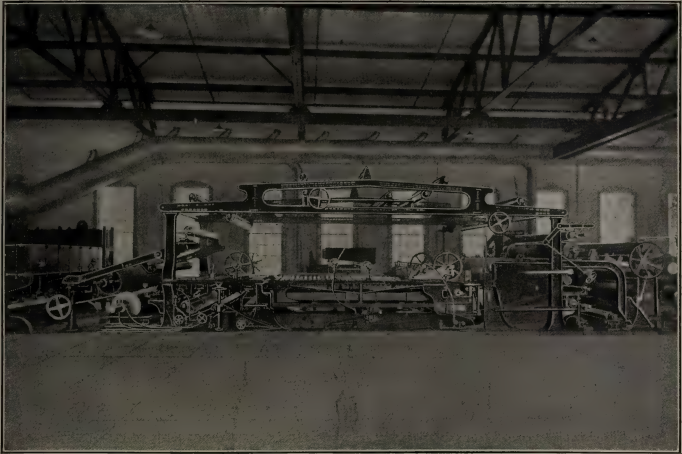

130" HARPER FOURDRINIER PAPER MACHINE.

This illustration is of the

**Ramsey Patent Single**

This valve is made also in what we call the **Double Pressure Type** where different pressures are used

**1 Pressure Grinder Valve**

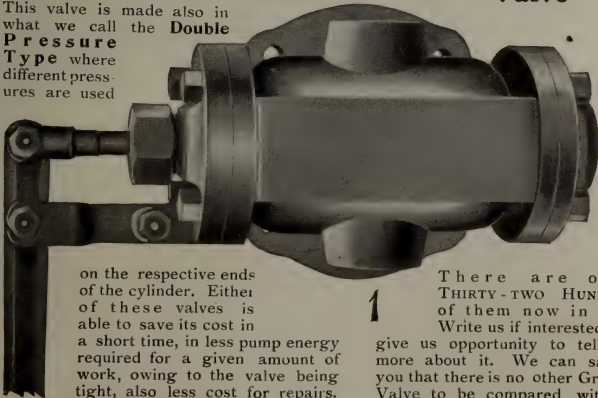

on the respective ends of the cylinder. Either of these valves is able to save its cost in a short time, in less pump energy required for a given amount of work, owing to the valve being tight, also less cost for repairs.

There are over THIRTY-TWO HUNDRED of them now in use. Write us if interested and give us opportunity to tell you more about it. We can satisfy you that there is no other Grinder Valve to be compared with it.

**Sole Manufacturers**

**BAKER & SHEVLIN CO., - Saratoga Springs, N.Y.**

Telegrams :  
"CALENDER, BURY"

Telephone :  
NUMBER 340

# Bentley & Jackson,

Limited

PAPER MAKERS'

.. ENGINEERS ..

BURY, - - ENGLAND

## *SPECIALITIES.*

MODERN HIGH SPEED NEWS PAPER  
MAKING MACHINES

SINGLE CYLINDER PAPER MAKING  
MACHINES

The NEW "*MARSHALL*" *PATENT REFINING ENGINE*, with separate adjustment to cones and discs, and our Patent Ball Thrust Bearing.

---

**APPLY FOR PRICES.**

---

OTTO WANDEL  
President

HERBERT H. MILLER  
Treasurer

# Wandel Screen Manufacturing Co.

WALPOLE, MASS., U.S.A.

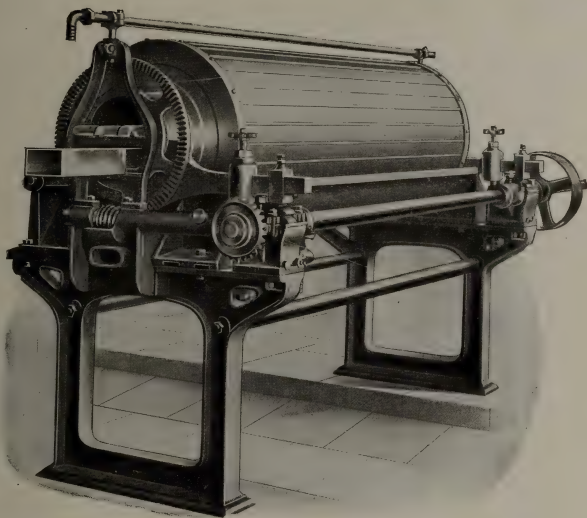

MANUFACTURERS OF THE

Quick Delivery.  
Write for Catalogue  
and list of users.  
We have no author-  
ized Agents in  
Canada.

# WANDEL ROTARY SCREEN

Over 200 Wandel  
Screens have  
been built and sold  
by us in the States  
within two years.

## SUPERIOR CONSTRUCTION



# NEW CENTRIFUGAL SCREEN

## WITH HORIZONTAL SHAFT

PATENTED IN ALL PRINCIPAL COUNTRIES

**SMALLEST POWER  
HIGHEST OUTPUT**

**DIRECT BELT DRIVE  
NOISELESS WORKING**

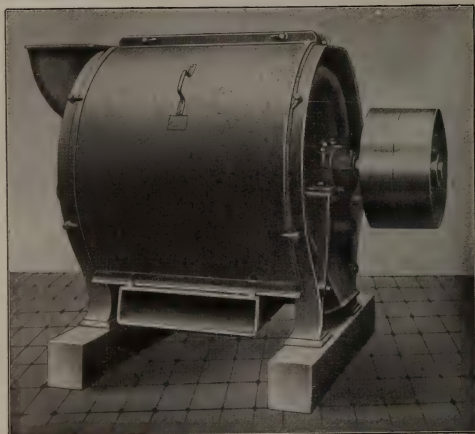

Equally well adapted for **GROUND WOOD**  
and **SULPHITE**.

*I have now sold over 800 of these Screens.*

➤ FURTHER DETAILS, PROSPECTUS AND PRICES ON APPLICATION. ➤

**Complete Machinery for Wood Pulp, Paper and  
Sulphite Mills.**

# J. M. VOITH,

*ENGINEERING WORKS AND FOUNDRIES*

**HEIDENHEIM ON BRENZ, WURTEMBERG, GERMANY**

Branch Office for Canada and U.S.A., 1008 Fifth Ave. Bldg., New York.

Representative: H. F. STORRER, C.E.

## The Improved "RUTH" Centrifugal Pulp Screen

To suit different conditions the "Ruth" is built as shown in the illustration, or with Steel Mitre Gears in a cast iron casing, independent of the footstep and running in oil, insuring long life of the gears.

It is also built **without gears**, using top pulley or motor drive. In this construction the screen plate sections can quickly be taken out and replaced through side doors.

All parts are easy of access, and no clogging of inlet or plates can take place.

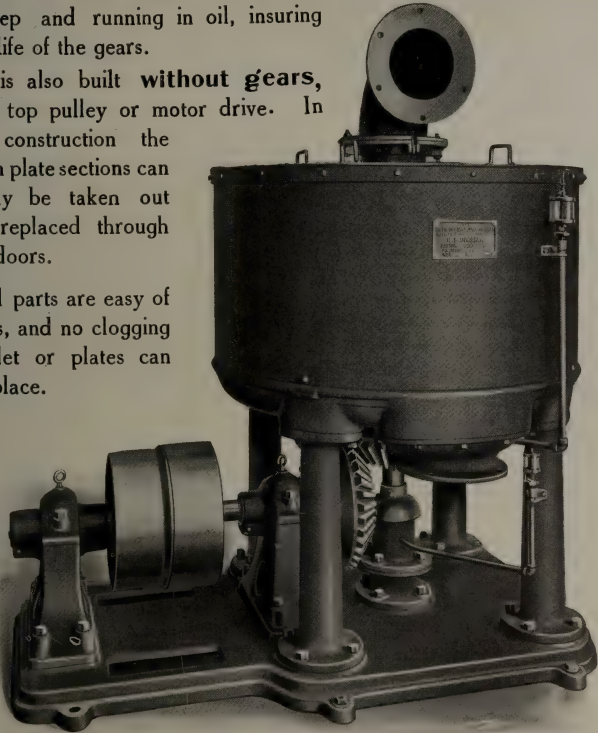

Other prominent features are—

- Simplicity of Construction.
- Small amount of power required.
- Great capacity and Low cost of maintenance.
- Lowest amount of fibre with the tailings.

In these respects this Screen is NOT surpassed by any other Screen in the market.

**P. P. Westbye, M.E., Peterborough, Canada**



## GARLAND PULP LOG Storage and Conveying SYSTEMS

Inventors of the CABLE CONVEYER

We have equipped 50 of the best American PULP and PAPER MILLS with CONVEYERS, LOG CUT OFF SAWS, SLASHERS, SPLITTERS, BAND MILLS and SPECIAL MACHINES.

Send us your plans or ask for  
Representative to call on you

### THE M. GARLAND CO.

Manufacturers of CONVEYING, SAW MILL  
and WOOD DESTRUCTIVE MACHINERY

BAY CITY  MICHIGAN, U.S.A.

# Have You Heard the Facts About The Beloit Machines?

---

---

One Fourdrinier built for 500 feet has run 615 feet, and averages 550 feet and makes 72,000 lbs. of print in 23 hours, 110 inch trim.

Another, built for 350 feet, for manillas, is running 490 feet every day on print.

Two others, built for 250 feet on book, are now speeded up to 340 feet on book.

A cylinder machine built for 40 tons of strawboard has made 89 tons in 23 hours, and averages 76 tons per day, dryers are 116 inch face.

---

---

## Beloit Iron Works

BELOIT, WIS., U.S.A.

# DILLON MACHINE CO

BUILDERS OF

## PAPER MILL MACHINERY

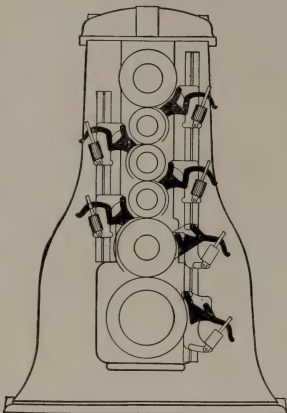

*DILLON DOCTORS  
AND  
FEEDS*

*DILLON MACHINE CO.  
LAWRENCE MASS.*

Beating Engines  
 Washing Engines  
 Jordan's Three Sizes—  
 Single, Double & Triple  
 Stuff Pumps, with  
 Dillon Patent Valve  
 Seating

Brannan Patent Paper  
Folders

Horizontal and Vertical  
Stuff Chests

Single and Double Paper  
Cutters

Backstands

Plates, Knives and Bars

DILLON  
 PATENT  
 DOCTORS  
 AND FEEDS  
 MADE IN  
 CANADA  
 BY THE  
 SHERBROOKE  
 IRON WORKS,  
 SHERBROOKE, P.Q.

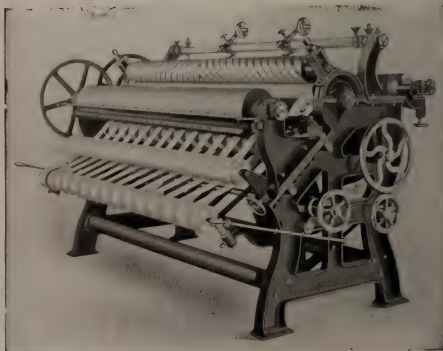

# LAWRENCE, MASS., U.S.A.



---

---

# THE MOORE & WHITE CO.



PHILADELPHIA, PENN., U.S.A.



SEND FOR BULLETIN.

---

**V**ERY severe tests have been made of this winder, but all of them have exceeded expectations. The photograph shows the winder attached to our standard slitter part which takes up less room than any other slitter and has several very good features. The winder can be used as a rewinder by attaching a back stand to carry the roll which is to be rewound.

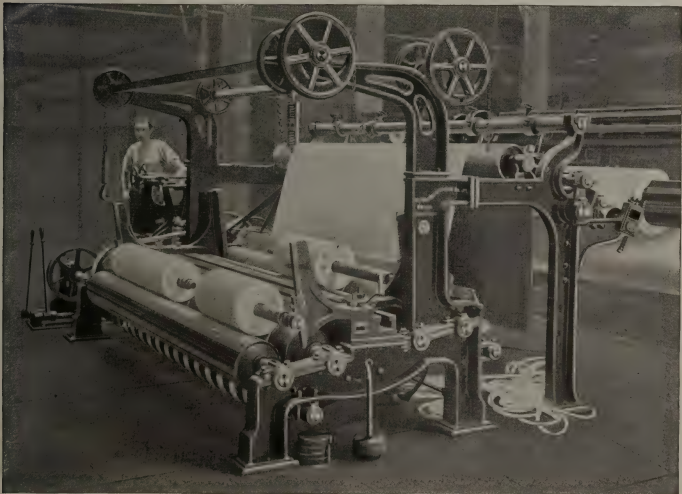

"M & W" Patented Four Drum Winder in operation.

**SATURATING, COATING AND WATERPROOFING  
MACHINERY**

**SPEED CHANGES**

**FRICTION CLUTCHES**

---

---

# HOLYOKE MACHINE COMPANY

HOLYOKE, MASS., U.S.A.

MANUFACTURERS OF

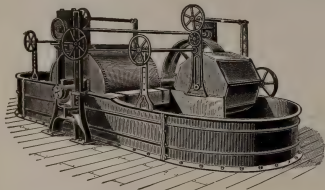

Washing and Beating Engines with  
Patent Double Hoist and Tubs of either  
wood or iron.

Hydraulic Pumps and Presses.

Rag Cutters and Rag Dusters.

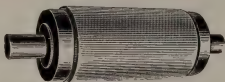

Cotton and Paper Rolls with Patent Fastenings.

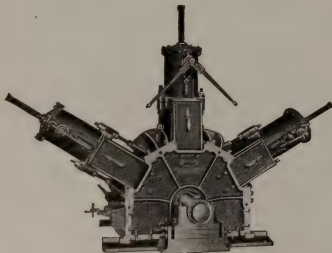

Patent Improved Wood Pulp Grinder.

Elevators, Rotary Fire Pumps and  
Friction Gearing.

Gears Accurately Spaced and Planed.

Shafting, Pulleys and Mill Work.

Machinery for Wood Pulp and  
Paper Mills.

Vertical and Horizontal Water  
Wheels with Flumes and  
all connections.

Wood Barkers, Wood Chippers  
and Wet Machines.

## Newest Designs

AND

## Highest Efficiency

Calenders. All kinds of Super-  
Calenders, Friction Calenders  
and Platers.

Chilled Iron Rolls.

Special Machinery

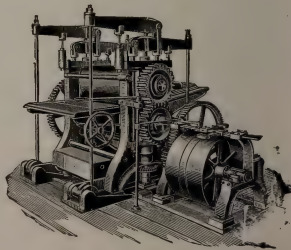

Description and Estimates Furnished; also Gear List  
and Catalogs sent on application.

# Pulp Wood Barker Bache Wiig Patent

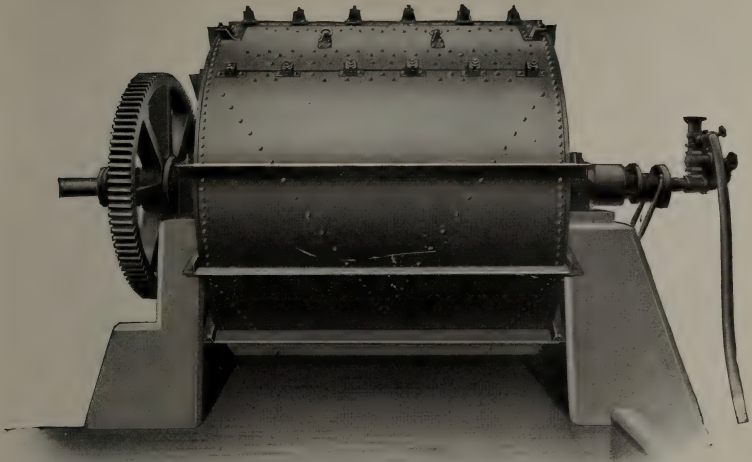

## THE LOSS WITH BARKING DRUM

Round wood covered with bark	-	-	-	8%
Slabs	-	-	-	23.8%
Edgings	-	-	-	9.4%

## LOSS WITH KNIFE BARKER.

Round wood covered with bark	-	-	-	22 to 24%
Slabs	-	-	-	50%

# The Jenckes Machine Co., Ltd.

General Offices: Sherbrooke, Que.

Factories: Sherbrooke, Que., St. Catharines, Ont.

Sales Offices: Sherbrooke      Montreal      St. Catharines  
Porcupine      Cobalt      Rossland      Vancouver

---

---

# JAMES BERTRAM & SON, LIMITED

LEITH WALK

EDINBURGH, - - SCOTLAND

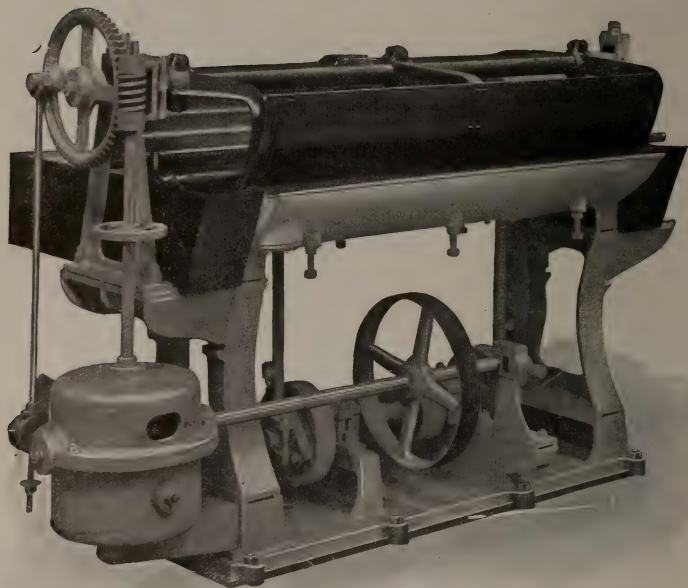

## “Whites” New Patent Strainer

With Oscillating Motion—Easily Cleaned.

Full Particulars on Application.

Telegrams—Bertram, Leith

---

---

# Battery Machines

(Save-Alls and Pulp Thickeners)

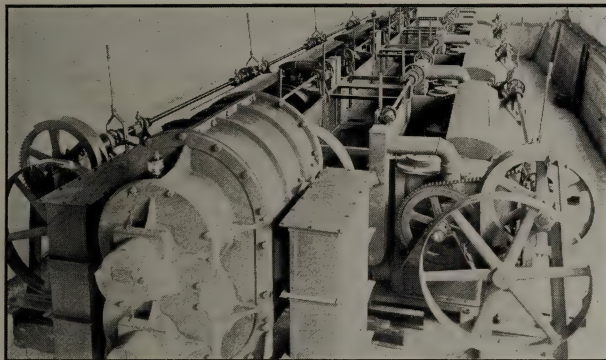

These pneumatic machines are operated in compact rows, by one blower, and by one line of shaft to each row. They have positively standardized the processes of thickening pulp and extracting stock from waste water.

Their operation is automatic, and is automatically maintained at the desired rate or density of output.

Their delivery is continuous, and the operation of the entire battery is in plain view, unobstructed by top gear or overhead connections.

No other class or make of pulp mill machinery affords the operative or the superintendent such a chance to keep his work up to the standard, without waste of time, power or stock.

---

SEND FOR FULL DESCRIPTION

---

**Sherbrooke Machinery Company**  
Limited

SHERBROOKE

. . .

QUEBEC



**PRESTON'S**

# Lining for Sulphite Digesters

TOTAL THICKNESS ONLY 2½ TO 2¾ INCHES

Resists the action of the acid and ensures absolute protection to the Digester Plates.

Great durability, therefore large saving in upkeep and repairs.

Larger internal space and increased production on account of the small thickness occupied.

Extensively adopted by Scandinavian and Continental Mills.

Over 200 Digester Linings in work and on order.

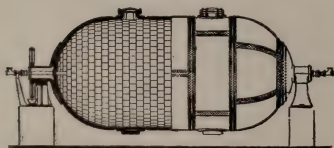
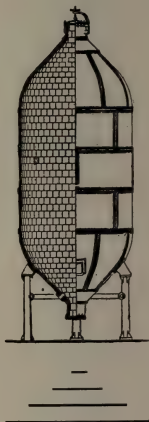

Telegraphic Address :

“ **PRESTONS, RADCLIFFE.** ”

CODE USED, A. B. C. 4TH & 5TH EDITION.

*Full Particulars and Prices on application to SOLE MANUFACTURERS*

## PRESTON'S DIGESTER LINING CO., LIMITED

RADCLIFFE, near Manchester, Eng.

—\*—  
WHOLESALE LUMBER YARD  
BURLINGTON, Vt.  
—\*—

*J. R. Booth*  
Manufacturer!

—\*—  
LUMBER  
PULP AND PAPER  
—\*—

*Ottawa, Ont.* Dec. 8th, 1910

The Green Bay Barker Co.  
Green Bay,  
Wis.

Dear Sirs,

In reference to the Rotary Pulp Wood Barker.

I have four of these in operation, and I find them very satisfactory, particularly on small or crooked wood, and I find quite a saving over the old style of Barkers; they will also do considerably more work. As far as I know there have not been any repairs required on mine since I got them. I can recommend them to any one requiring a good Barker.

Yours truly,

*J. R. Booth*

CABLES, "PUMPS, BURY"

# WALMSLEY'S

We have Paper Making Machines 175 in. wide,

---

Walmsley's Enclosed

FITTED WITH

Specially adapted for the

## DRIVING OF PAPER MACHINES

GIVING A VARIATION OF 10 to 1.

ESTIMATES GIVEN FOR

---

CHARLES WA  
PAPERMAKERS'  
ENGINEERS,

HIGH SPEED

# Papermaking Machines

making paper at over 600 feet per minute.

---

# Steam Engines

FORCED LUBRICATION

OVER 280 OF THESE ENGINES SUPPLIED

FOR PAPER MACHINE DRIVING ALONE.

COMPLETE PAPER MILL PLANT

---

# LMSLEY & Co.,

BURY,

LIMITED.

Near MANCHESTER.

# Wilson-Paterson Co'y



127 BOARD OF TRADE BLDG., MONTREAL.

Agents for the United Alkali Co. of England

## **OFFER TO THE TRADE:**

Caustic Soda 60° to 78° Soda Ash, Caustic Potash, Sal Soda, Silicate of Soda, China Clay, Rosin size and a full line of Rosins, direct shipment from the south.

**Contracts made for regular supplies.**

# PARSONS TRADING COMPANY

EXPORTERS OF PAPER TO ALL PARTS OF THE WORLD

20 VESEY STREET, NEW YORK

BRANCH OFFICES AT

LONDON

SYDNEY

MELBOURNE

WELLINGTON

CAPE TOWN

BOMBAY

HAVANA

MEXICO, D.F.

BUENOS AIRES

**CORRESPONDENCE WITH MILLS SOLICITED**

# THE CARTHAGE CHIPPER

WILL INCREASE YOUR CHIPS. WILL  
DECREASE YOUR SAWDUST. By virtue  
of its Design and its Patent Feed Spout it takes a  
MINIMUM AMOUNT OF POWER.

---

Ask Anglo- Newfoundland Development Co.  
Ask Laurentide Pulp and Paper Company.  
Ask The Riordon Paper Company, Limited.

---

OR WRITE

**CARTHAGE MACHINE CO.**  
**CARTHAGE, N.Y.**



# Pulp and Paper Magazine of Canada

A Magazine devoted to the interests of Canadian Pulp  
and Paper Manufacturers and the Paper Trade.

SUBSCRIPTION PRICE: \$2.00 a year. Single Copies, 20 cents.

The Pulp and Paper Magazine is published on the second Tuesday of each month. Changes of advertisements should be in the Publishers' hands not later than the 1st of the month, and, where proofs are required, four days earlier. Cuts should be sent by mail, not by express.

PUBLISHERS:

BIGGAR-WILSON, LIMITED,

Confederation Life Building, Toronto, Canada

---

## Experimental Pulp and Paper Laboratory.

The article on another page, by Mr. H. R. MacMillan, of the Dominion Forestry Department, Ottawa, should be read with particular interest. We believe the time has arrived—if not indeed overdue—for the establishment in Canada of a pulp and paper testing laboratory, similar to those in other countries. The science and business of agriculture have been advanced untold stages by the aid which has been granted by the Dominion and Provincial Governments, and while this has cost money, it has been repaid a hundred-fold. The manufacturers should pull together with this object in view. Some of them, it is true, may be inclined to leave well enough alone, on the ground that the industry is prospering already. But this is a shortsighted argument. Granted that the pulp and paper mills of Canada are carrying on a successful business to-day, and that all the prospects are rosy, is that any reason why times should not change and business

become depressed? At such a time as that, every little economy counts, and they may then wish they had taken advantage of all the little savings and the greater expertness which scientific investigation brings about—and wish in vain, because it takes some time to get an experimental laboratory in running order, and longer still to obtain authentic results. But even if the present era of prosperity continues, which we are glad to say there is no immediate reason for doubting, is there no reason why we should do our best to perfect the methods of the industry?

There are many details in the process of manufacturing pulp or paper in which accurate knowledge, scientifically acquired, would do much to accelerate or to improve the final results. And then there are several woods which, while perhaps not fully equal to spruce as a pulp producer, might yet become highly valuable, if the best methods of treating them were known. It would be

the purpose of a government experimental bureau to find these things out and to make known the results of its enquiries to the industry at large.

The manufacturers of the United States discovered some time ago the need for enquiry of this class and the work of the government's laboratories at Madison and Wausau, Wis., is encouraged in every possible way by the American Pulp and Paper Association. Some of the problems dealt with in those institutions are referred to in the above-named article. Germany, Scandinavia and other countries also have experimental laboratories, and we hope to be in a position to furnish fuller particulars of their equipment and what they are doing in a future issue.

As is known to most of our readers, there is already the nucleus of a small experimental pulp and paper laboratory at McGill University, Montreal, and this location may be considered for some reasons a good one, though some might consider Ottawa or Toronto University as having equally good claims. But this is a question which may well be left open for the time being. The main point just now is to interest the Dominion Government and the people generally, in a plan which, as it would bring a great advancement of the pulp and paper industry, would mean millions of dollars for the country as a whole. It would not even be necessary to narrow the aims of the bureau to the needs of the pulp and paper industry, as it might quite logically include investigation into all woods, whether for paper-making or lumbering purposes generally. In the case of the Wisconsin institutions, a good deal of the machinery was donated by manufacturers of such equipment,

and perhaps they would be willing to do this in the case of a Canadian laboratory. We would bespeak for this suggestion their attention, also that of the pulp and paper mills and the government.



#### FOREST WEALTH OF NORTHERN ONTARIO.

Mr. Fred. W. Field, of The Monetary Times, did good work as special commissioner of the Toronto Board of Trade to investigate into the resources of Northern Ontario. His recently published report on the result of his enquiries shows how carefully and exhaustively he went into the task of finding his data, while his recommendations will doubtless have weight with the authorities who possibly have not realized what an enormous heritage the province possesses in its northern territory with regard to pulp, lumber and agricultural resources.

To some extent, the discussion of trade prospects and possibilities in a new country, which has known the railroad for only a few years, has the appearance of extreme prophecy. Such is the case in northern Ontario, but imagination can be reduced to something more substantial by examining the extent of natural resources, the amount of development work accomplished, the probable trend of future development, and the work on the part of the Provincial Government, Boards of Trade, municipalities and the individual which up to the present, appears to stand out most prominently.

The forest products of northern Ontario, says Mr. Field, should create new industrial life in that country, giving

employment to many thousands and producing a large revenue for circulation in the province. The Provincial Government has provided that all pine sawlogs, spruce pulpwood, and hemlock, must be manufactured in the Dominion, into lumber, pulp or paper. The effect of this decree should naturally increase the demand for labor, creating a market for many supplies. Canadian industrial development has been marked during the past decade, but it is doubtful whether any single industry has experienced such rapid progress as pulp and paper manufacturing. While the tariff has helped, Canada's natural advantages have figured most. These are:

- (1) Large areas of forest producing timbers best adapted to wood pulp.
- (2) More waterpowers than any other country in the world.
- (3) A population unusually well skilled in wood craft.

The report goes into details respecting the waterpowers of the north. One estimate gives the available supply at 2,030,600 horsepower.



#### UNITED STATES AND FAVORED NATION TREATIES.

It is fortunate that Canadians are not hyper-sensitive, or they might feel a little hurt at the Washington government's alleged reasons for refusing to grant to the Favored Nations the free admission of pulp and paper, as since July last it has seen fit to do to Canada. For the main point in Deputy Attorney-General Payne's argument on the government side before the board of General Appraisers in the matter of the protest of importers of foreign pulps and papers against the payment of duties,

was that Canada is not a country, a nation, or a state. This was in reply to the argument of the importers that the United States Government is certainly bound, by this, the Favored Nations Treaties, to grant the same privileges to those nations as she may at any time gratuitously grant to any other "country." The importers further argue that as the United States has already done this in the case of Canada, by means of section 2, which gives free admission of wood pulp and paper without any concession in return, she is morally and by treaty rights, bound to accord the same privilege to those other nations.

The government, on the other hand, attempted to show that the treaties in question were entered into before the middle of last century and were obsolete in their power to control trade now. Moreover, conditions in Canada were altogether different from those in the other countries referred to, Canada occupying contiguous territory, where the people were similar racially and in habits, wages practically the same, and the product came into the United States not as a foreign product, but manufactured under conditions identical with those that exist in the United States.

The principles involved on both sides are difficult and somewhat delicate, and it will be interesting to see the ultimate affect of the arguments and to note the decision.



#### CANADIAN PULP AND PAPER TRADE RETURNS.

The pulp produced in the whole of Canada in 1910 is estimated at 474,604 tons, produced from 598,487 cords of wood. The exports of wood pulp to all countries in the fiscal year 1911 were

valued at \$5,715,530, of which \$5,094,589 were exported to the United States and \$496,928 to Great Britain, leaving \$124,015 exported to all other countries. The tonnage is not contained in the official returns, but if we reckon the average value at \$38 per ton and then take 80 per cent. of this as representing ground wood and 20 per cent. sulphite, we would have 107,255 tons in ground wood and 26,813 as the tons in sulphite exported to the United States. The total imports of paper to Canada were valued

at \$4,646,014 in 1910, and \$5,537,411 in 1911, and the total exports of Canadian paper in 1911 were valued at \$3,953,283, of which \$2,076,543 were shipped to the United States, that is, practically one-half.

Of the total imports of paper in 1910 \$462,212 were of printing paper, and the printing papers imported in 1911 were \$631,810.

The details of the exports of wood pulp since 1908 are given below:—

#### Wood Pulp Exports.

	To Great Britain. Lbs.	United States. Lbs.	Other countries. Lbs.	Total. Lbs.
1908 .....	987,258	3,803,399	20,506	4,811,163
1909 .....	1,668,569	3,079,033	241,492	4,989,094
1910 .....	1,703,237	4,012,838	187,381	5,903,456
1911 .....	962,878	5,390,349	235,428	6,588,655

#### Values.

1908 .....	\$485,199	\$3,545,530	\$7,123	\$4,037,852
1909 .....	1,084,720	3,064,879	157,330	4,306,929
1910 .....	931,150	4,175,309	98,138	5,204,597
1911 .....	496,928	5,094,589	124,015	5,715,530

#### Total Exports of Paper, 1908-1911.

The following are the exports of paper to the United States and to all other countries since 1908:—

#### To United States.

1908 .....	\$995,280
1909 .....	990,156

1910 .....	1,319,541
1911 .....	2,076,543

#### Total.

1908 .....	\$3,554,437
1909 .....	3,523,816
1910 .....	3,185,324
1911 .....	3,953,283

#### EDITORIAL COMMENT.

Hon. Dr. Roche, Secretary of State, took the occasion presented by his annual report to Parliament, to express approval of the new system of calling for tenders in purchasing paper and stationery supplies. It will be remem-

bered that, when it was first put into operation, great exception was often taken to the stringency of the regulations, but the minister thinks that manufacturers and dealers now realize that in safeguarding the interests of the De-

partment there is nothing which acts unfairly to themselves. He went on to say that the prices paid by the department compare favorably with those paid by large jobbing houses for papers of grades similar to those of the bureau's standard lines, and that the wholesale stationery houses, when competing, quote prices as low, if not lower, than those given their best customers. The tender system is being extended to embrace all purchases, the total of which reaches figures of consequence during the year. Preference ought to be and, we understand, actually is given to Canadian manufacturers and paper firms.

\* \* \*

The Finance Committee of the United States Congress has reported favorably on a bill to repeal the reciprocity agreement, with the exception of section 2, which places unrestricted pulp and paper up to a value of 4c. per pound, on the free list. In other words, the whole of that abortive measure, with the exception of the part affecting the pulp and paper industry, which was provided for by a beneficent administration to lose anyway, is to be struck out of the statute books. The United States, or rather the authors of the bill, evidently think that to hold the door still open is offering the people of this country too much of a temptation to change their mind. We do not think, however, the United States need worry on that score.

\* \* \*

Hon. G. E. Foster, Minister of Trade and Commerce, is to be appointed as representative of Canada on the Inter-Imperial Commission to investigate and encourage trade between the various parts of the Empire and to find out to what extent the trade between the sev-

eral over-seas Dominions has been affected by existing legislation. This proposed commission is the result of the Imperial conference held last June in London. One part of the Empire to which Canada might well give greater attention in the way of encouraging mutual trade, is Australia, with which country attempts have been made to bind Canada through a preferential tariff and other means, but so far without result. The United Kingdom, Canada, Australia, New Zealand and South Africa, have all trade interests which might be furthered by the data found out and the recommendations laid down by such a commission, and there can be no doubt as to the qualifications of the proposed Canadian representative.

\* \* \*

Few people can realize in advance the potentialities of the Panama Canal, or the wonderful effects it may have upon the world's commerce. It is safe to prophesy, however, that the Pacific Coast, both American and Canadian, will reap advantages almost undreamed of. And it will certainly be safe for ports and shipping interests on the British Columbia coast to make arrangements in good time for the great increase in business which is sure to ensue at its completion. These arrangements should most assuredly be made now, for the coast cities of the United States are already engaged in preparing for the future, and trade routes once established are difficult to disturb. When British Columbia becomes a great pulp and paper shipping province, as is quite conceivable in the not far distant future, the interest of the paper industry in the far western route will doubtless be keen, but the moral is, get ready now.



While it is never safe to speak too definitely of a large merger until the combination be actually an accomplished fact, yet it must be said that the rumors of a coming merger of large pulp and paper concerns will not down. The manner in which leading pulp and paper stocks have been booming on the exchanges during the past few weeks would naturally lead one to imagine that there is something more than newspaper talk behind the reports, and that financial men usually "in the know" are assured that something of the above nature is quite likely to take place. Whether it will be so far-reaching, however, as some believe, is another matter. At one time or another practically all the large concerns have been mentioned in this connection, but particular reference is made to the Wayagamack, Laurentide, Belgo-Canadian, Eastern Canada, and Ontario Pulp and Paper Companies. Sir Rodolphe Forget, who has already made his mark as a financial organizer and who is heavily interested at present in pulp and paper enterprises, is the man towards whom the reports chiefly converge.



#### MANN vs. ST. CROIX PAPER COMPANY.

The case of Mann vs. St. Croix Paper Co. was referred to last month. This action was brought in the New Brunswick Court to recover for the difference between the scale of logs allowed by the defendants and that claimed by the plaintiff. The parties had entered into a contract by which plaintiff was to cut logs from the defendant's limits, mark, haul and deliver them at a specified place for \$8 per M.

The contract contained a provision that the logs should be scaled by com-

petent persons, to be appointed by the defendant company, and that they should be scaled, by the scalers, "equal to what, in their judgment, would make good, merchantable lumber."

The logs were scaled by what is known as the "Bangor rule," with certain allowances in favor of the operator, and nothing was deducted for seamy or crooked logs, in short, for nothing but what was rotten.

The plaintiff contended that he should receive the New Brunswick pulp scale which, by legislation enacted in 1910, provided for the measurement of logs intended for pulpwood at the middle diameter in the absence of express agreement.

He also set up that there was a collateral, oral agreement between defendant's company's manager and himself that he should receive a scale such as he had received in previous years. The manager was a new man and claimed that he had never heard of such a mode of scaling as the plaintiff says he previously got, but the jury formed against them on this point.

The plaintiff was allowed 25 per cent. increase over the cut for which he had been paid, and the case has been taken before the Supreme Court, where it was argued last month. It is practically now a question of the construction of the written contract and whether that is affected by the alleged verbal understanding. Judgment can not be given until the middle of April, and may be deferred until June next.

The St. Croix Paper Co. was represented by J. B. M. Baxter, K.C., assisted by Attorney-General Grimmer.



—A fashionable firm of West-end London dress-makers were detected in the fraud of applying the term, "colonial silk" to a coat which was really made of wood pulp, and were fined about \$225.

—F. Reddaway & Co., manufacturers of "Camel" brand belting, etc., will on the 1st prox., move their offices and warehouse to 595 St. Paul St., Montreal.

## ARGENTINE PAPER TRADE.

---

In addition to the information given in last issue respecting the opportunities for exporting Canadian paper to the Argentine Republic, the following particulars, supplied by H. R. Pousette, Canadian trade agent in Buenos Ayres, will be of interest to manufacturers:

It must be noted that many articles in the Argentine customs tariff have a specific value, for customs purposes. For instance, printing paper is assessed at 6 cents gold per kilo, and as a dollar Canadian is equal to about \$1.03 Argentine gold, and a kilo equals two and one-fifth pounds avoirdupois, this arbitrary valuation works out at approximately \$53 a ton avoirdupois. The duty on this commodity is 2.12 cents per kilo.

The Argentine presents a profitable market for the manufacturers of printing paper. Owing to the paper industry being a prominent one in Canada and likely to grow to much larger proportions in the future, this trade should be of particular interest to the mills, or to those which may be reaching out for an extended market.

The detailed statistics for 1909, the latest to date, show that for the quinquennial period ending that year, the republic imported 59,440,918 kilos, or, approximately 60,000 metric tons, valued at \$3,566,449 gold. A metric ton is equivalent to 2,200 lbs. The average for the five years was about 12,000 tons per annum. But the consumption of this article would appear to be a rapidly increasing one, as the imports for the year 1909 amounted to over 16,000 tons, which marked an increase over the previous twelve months of nearly 3,500 tons. The fiscal year, ending December 31, 1910, bears out this statement, for the imports rose to 23,602 metric tons, and the returns for the first nine months of 1911 furnish further proof, as during this period, they are given at 19,544 tons, which is 2,272 tons

better than the same period of the preceding year.

Although the Dominion has vast pulpwood forests, unmeasured water-power, large mills, and, in every way, would seem to be intended by nature to be the greatest producer of paper in the world, up to the present, her manufacturers have evinced but small interest in this great market. From the 1909 report, it is found that Canada is credited with a poor 1,747 tons, for the quinquennial period ending that year, and that her trade was declining, for in the last twelve months her shipments only amounted to 49 tons, a decrease of 480 tons from the previous year. For the quinquennium mentioned, Germany's exports were 25,000 tons, the United States' 20,000, Sweden's 8,000, and the United Kingdom's a little over 3,000. All of these countries bettered their averages in the last year, except the United States, the figures being approximately, Germany 8,000, the United States 2,238, Sweden 3,627, and the United Kingdom 2,299.

As stated above, no later information is available from customs statistics, to indicate the direction of trade by countries, but if the sources available are to be credited, the United States has succeeded in the last two years in placing herself in the front rank. If this be true, it would seem to be due to the efforts put forth by a certain large company. This firm has established its own agency, has its own local wagon transport—at least, the wagons are all marked with its name—and maintains a sufficient quantity on hand at all times to place its customers beyond the fear of strikes, or other unforeseen inconveniences. This company is stated to have dropped its price in front of the German companies, and so secured valuable contracts, and by its wise policy of protecting customers,

and granting every facility, it has succeeded in putting itself into a very enviable position. Needless to say, this is reflected in a better profit by the company.

This is a matter for reflection to Canadian paper mills. Of course, they will know best if they are in a position to compete against the United States exporter, and are the only judges as to the value of this market. There is little doubt but that they can compete if they wish, in fact are doing so in a small way; nor is the desire to sell largely to the newspapers of this republic absent; but apparently, such efforts as have been put forth by Canadian mills have been of a desultory nature—at least, so it is averred—and have lacked determination and system.

Assuming that the Canadian mills can compete with those of the United States and Germany, the affair does not appear to be very complicated. First, a permanent agent must be secured. This need not involve an agency controlled and paid from Canada, although such might furnish the most efficient results. But it may be taken as a *sine qua non*, that if the representation be entrusted to a firm, that firm must be reliable and progressive.

There are two classes of agents who may possess these qualifications; one will secure the orders, but leave the financing to the company; the other who will buy outright from the mill. Undoubtedly the one more likely to win the confidence and business of the newspaper people, will be the latter, as if he has warehouse facilities, financial resources, and a good name, he will be in a position to afford them the assurance of regular supplies that is so necessary, and if fair dealing that is so desirable.

But whatever the arrangement may be, a permanent representative is essential to success. Some mills have tried the experiment of sending a man to this country periodically, to call upon the newspapers; but the plan has not answered. The publishers here will not be

hurried into making contracts, and for good reasons or no reasons at all, will not infrequently put an agent off many times, so that he may have to return again and again. In addition there is a certain time in the year when contracts are made and renewed, so that it is practically useless to try to do business at any other. Besides, the personal factor enters largely into these matters.

The German method of packing is to enclose each roll in wood, but this adds much to the cost that is not warranted of the risk of damage. The United States shippers content themselves with wrapping each bale in burlap, which, with careful handling, is sufficient. But packing is a matter for discrimination, and should depend upon the treatment likely to be experienced. For example, if a consignment were destined to a port where it would be necessary to transfer it to lighters in the open roadstead, the packing would necessarily need to be more secure than if discharged on to a quay, or even into lighters inside of a harbor.

Where a vigorous campaign may have been determined upon, it would be well to consider the permanent maintenance of an expert from the factory, on this continent. Such a man, with, say, his headquarters in Buenos Ayres, would be in a position to aid not only the agents in this republic, but those also in Brazil, Uruguay and Chili, in selling the factory's product, and he would be available for technical advice whenever this might be necessary.

The terms of payment for printing paper vary. Some contracts are for cash, some are arranged for bills at three months, and others for six; it depends on the financial resources of the newspaper, its standing, &c. When the agency is in the hands of a firm who buy outright, the question of credit only applies to that party. But where on the other hand it is in the hands of a commission merchant, it is desirable that he should assume some, or all, of the financial responsibility for the orders sent in by

him, protecting himself if necessary, by insuring the stability of his customers.

The subject of credit is an important one, and for that reason it is the intention to refer to it at greater length in a later report. Some manufacturers in Canada appear to have a very hazy idea as to the system by which shipments not sold for spot cash are financed; and the mere mention of credit is sufficient for them to conjure up doubts and fears about risks.

Much space has been devoted to the subject of printing paper, but this is justifiable, for here in Argentina is a market that has doubled its consumption of the product within the last two years. In 1908, the imports were just over 13,000 tons, and last year, if the first nine months' average was maintained to the end, should show a total of 26,000 tons. And this is but one republic of this vast and rich continent, albeit the wealthiest and most prosperous of them all.

It may be that no one mill is capable of taking care of Argentina's trade, and in that case it would seem a fitting opportunity for two or more to co-operate; or on the other hand, several may desire to enter the field, in which case it might lead to unsatisfactory competition, and again co-operation might be highly effective. The trade of this country is large, that of the continent still more so.



#### PAPER FOR MAPS.

A writer in the "Papier Fabrikant," in referring to the manufacture of a good paper for maps, says:—In mills not possessing a separate department for treating rags, successful manufacture of this paper for maps is scarcely possible. The entire treatment of the rags is here according to quite definite laws whose observance is scarcely practicable in a half-stuff mill. In an English paper mill we employed principally the best linen pulp with an admixture of very small quan-

ties of esparto and bleached cotton pulp. The linen rags cut into pieces the size of a hand were boiled for six hours with about 4 kg. soda at 4 atmos. in a rotating digester of about one ton cubic contents. The pressure should increase only gradually, and the maximum pressure should be used for only two hours. The pulp is then gently washed in the digester after it has been left for some time in chests, and treated with fairly sharp blades in the pulping engine. The pulp should be left in the drain chests for at least a week, then beaten with sharp blades and a high density of pulp, and then equalized by a refining engine. The pulp should run quietly on to the wire without the formation of eddies. The water should be removed by the suction apparatus and presses as uniformly as possible, because otherwise there is readily a tendency to becoming wavy. The tension of the paper both on the wet part and also between the drying cylinders should be as great as possible. The first cylinders should be heated only very slightly. In many mills fan blades are connected into the dry part in order to dry as naturally as possible. The machines for making these papers should not be more than 170 to at most 200 cms. broad, and they should work only at moderate speeds.



—"Ottawa, Canada, the Great Cheap Power City—Illustrated," is the title of a nicely gotten up book issued by Herbert W. Baker, commissioner of the Publicity and Industrial Bureau of that city. Some of the reasons why manufacturers, capitalists and business men should investigate the opportunities presented by Ottawa, are given as follows: cheapest power, raw materials convenient, splendid industrial sites, advantageous freight rates, rail and water transportation, comparative low cost of living, favorable labor conditions, population of 4,127,000 living within 300 miles, direct quick haul to western markets.

TABLE EMBODYING RESULTS OF PAPER STRETCH EXPERIMENTS.

DESCRIPTION OF PAPER.	Amount of Stretch shown in decimals of an inch.		Stretch shown in decimals of 1-32nds of an inch.		Re-drying Shrinkage to less or Stretch to more than 12 inches calculated in decimals of 1-32nds inch.	
	Along the Web.	Across the Web.	long the Web.	Across the Web.	Along the Web.	Across the Web.
1. Litho. printing double crown 60 lbs. at 2¼ d. lb. Sulphite and grass...	.44375	.265625	1.4	8.5	-1.0	0
2. Plate paper royal 60 lbs. at 6d. lb. Linen rag, slightly loaded .....	.028125	.234375	.9	7.5	-2.0	-1.0
3. Antique laid double crown 24 lbs. * at 2¾ d. lb. Esparto grass .....	.03125	.140625	1.0	4.5	-1.0	-.2
4. Antique laid double crown 45 lbs. at 5¼ d. lb. Rag with a mixture of loading only .....	.015625	.11875	.5	3.8	-1.0	+.5
5. Cream wove plain double crown 25 lbs. at 3¾ d. lb. Rag (unloaded).	.028125	.28125	.9	9.0	-1.2	-2.0
6. Superfine litho. royal 48 lbs. at 2⅞ d. lb. Esparto grass .....	0	.125	0	4.0	-2.0	-1.5
7. M.G. litho. double crown 23 lbs. at 2¼ d. lb. Sulphite, free from mechanical wood or loading ....	.025	.109375	.8	3.5	-2.0	-.5
8. M.G. litho. poster double crown 40 lbs. at 2¼ d. lb. Sulphite, free from mechanical wood or loading.	.03125	.0625	1.0	2.0	-1.2	-1.5
9. M.F. printing double crown 33 lbs. at 2d. lb. A good deal of mechanical wood and loading ....	.0625	.328125	2.0	10.5	-2.5	-3.0
10. Plate paper royal 70 lbs. at 7½ d. lb. Rag (linen) .....	0	.125	0	4.0	-2.0	-1.4
11. Good printing royal 48 lbs. at 2⅞ d. lb. Esparto grass paper .....	.015625	.21875	.5	7.0	-2.5	-2.0
12. Antique laid double crown 50 lbs. at 2½ d. lb. Esparto grass paper...	.015625	.0625	.5	2.0	-1.5	-1.0
13. Antique laid double crown 50 lbs. at 2d. lb. Mechanical wood about 80 per cent. ....	.046875	.125	1.5	4.0	-1.2	-.5
14. Collotype Imperial 80 lbs. at 4d. lb. Esparto and rag .....	.00625	.109375	.2	3.5	-1.5	-1.5

—The Ontario Paper Co., Ltd., which, as stated before, will establish a large paper mill at Thorold, will start actual construction work almost immediately.

—Mr. Roy, recently appointed by the

Canadian Government trade commissioner in Paris, France, reports that Canadian pulp, both mechanical and chemical, are products of great interest in the French market.



# THE NEED FOR A CANADIAN EXPERIMENTAL PULP AND PAPER PLANT.

By H. R. MACMILLAN.

*Domestic Forestry Dept*

When the various governments of Canada, Provincial and Federal, have been considering appropriations and plans for aiding and developing the productive industries which constitute the life of the country, one important industry has been overlooked. Agriculture, in all its branches, owes much of its progress to experiments conducted by the different governments and to educational facilities provided by the governments, the fisheries of Canada are protected and propagated by the government, government exploration parties have located many of the most wealthy mining fields, and a Department of Mines is maintained to investigate and improve the mining methods and metallurgical processes of Canada. The smelters and iron and steel mills of Canada have been rendered possible by large cash subsidies. The production of crude petroleum has been encouraged by a subsidy from the Federal Governments. The one great industry which has received no direct government assistance is the manufacture of wood pulp and paper.

The pulp industry does not need the kind of assistance given to the owners of smelters, oil wells and steel mills,—a cash subsidy paid to encourage the investment of capital in plants which cannot, without artificial assistance, produce profits. What the pulp industry needs, both for the good of the country and for the good of the pulp industry, is the type of assistance given to agriculture, the establishing and maintenance of experimental laboratories where skilled chemists and pulp and paper experts will be encouraged to develop uses for woods, and wood waste now thought unsuitable for use in wood pulp manufacture.

Public assistance extended to the pulp industry will profit the country one

hundred fold, both directly and indirectly. The direct return will come from a closer and wiser utilization of the forests of Canada which are owned by the different governments and which are large sources of revenue for the governments. There are three trees in Eastern Canada which occur in pulpwood forests, which are not adapted for pulp under present methods of manufacture, and which because of their low value for any other purpose are at present, to a large extent, wasted when pulp limits are logged over. These trees are jack pine, hemlock and tamarack. If any government experiments could devise a commercial means of converting these trees into pulp and paper, the added revenue accruing to the government from the use of these trees would pay the cost of the experiments. Similar trees in Western Canada which await experimenting are western larch, douglas fir, western hemlock and lodgepole pine. These trees are cut for lumber at present, and a great waste ensues because the small logs, the tops and other portions cannot be used, are left in the woods and no royalty paid. If the government would demonstrate and encourage the use of these species, the closer logging of the forest would mean a great increase in dues.

The profit which would come to the government and the communities from the establishing of more pulp mills cannot be estimated. In 1910 there were produced in Canada about 370,200 tons of mechanical and about 104,400 tons of chemical pulp. Investigations by the United States tariff board show that it costs in labor and other expenditures \$9.56 to produce a ton of mechanical pulp in Canada, and \$26.47 to produce a ton of sulphite chemical pulp. There was a total expenditure of about \$5,433,000 for the manufacture of pulp in Can-

ada in 1910. The average mill in Canada produces 7,260 tons of mechanical pulp, and 200 tons of chemical pulp per year. In the one case it means an expenditure of \$69,500 per year, in the other case an annual expenditure of \$4,300. Government investigations in the manufacture of pulp would surely lead to the establishing of more mills. When each mill means \$73,800 per year to the country in which it is located, surely government assistance to the pulp industry is worth while.

Both in the United States and in India where the conditions are not so favorable to the pulp industry as in Canada, the government has established laboratories and employed experts for the study of more economical methods of making pulp, or to learn, if possible, new and cheaper fibres.

At Wausau, Wisconsin, a ground wood pulp mill was built by the Federal Government for the express purpose of carrying on experiments useful and of interest to pulp makers. This mill is not equipped with a paper machine. The inside dimensions of the mill are 100 x 200 feet, and it is equipped with:—

- 1 40-inch swing cut-off saw.
- 1 Green Bay Barker.
- 1 Friction pulley, 3 pocket, grinder for 54-inch by 27-inch stone.
- 1 Gould's triplex pump 5-inch by 8-inch.
- 1 Gould's triplex pump 4-inch by 6-inch.
- 2 Gould's 6 triplex centrifugal pumps.
- 1 Gould's 5 triplex centrifugal pump.
- 1 Connersville vacuum pump.
- 1 Storage tank—9-feet diameter by 9-feet high.
- 1 Ruth centrifugal screen.
- 1 Harmon Machine Co.'s flat screen.
- 1 Improved Paper Machine Co.'s hydraulic, three roll, wet machine.

Electric power is used. Individual motor drives are provided for each piece of machinery with the exception of the swing cut-off saw, the barker and vacuum pump, all of which are driven by a single motor.

A 500-h.p. variable speed d.c. motor is directly connected with the pulp grinder. The current delivered to this motor is converted from alternative current to direct current by means of the motor generator set and the speed may be varied from 100 to 300 revolutions per minute.

The equipment also includes a number of pieces of analytical apparatus such as balances, stereopticons and standard electric instruments.

The wood is fed to the grinder and the pulp produced is pumped to the storage tank. It is pumped to the screens and led by gravity to the wet machine. The laps or bundles of pulp are shipped to commercial paper mills for testing.

The cost of installing the machinery in the mill was about \$40,000. The yearly cost of carrying on the experiments has been about \$20,000.

The mill is operated by a technical staff of three and a skilled staff of three, in addition to a stenographer.

The technical staff consists of a chemical engineer in charge of the work. The chemical engineer at Wausau is Mr. J. H. Rhickens, who studied paper making at the University of Wisconsin, and had practical experience in the paper industry and at electrical engineering before taking up this work. He supervises the laboratory work, prepares plans for carrying out the different tests and keeps the electrical equipment of the plant in running order. The chemical engineer also makes examinations of fibre.

There are two assistant chemical engineers. One looks after the electrical machinery and supervises the tests and conducts such analytical work as he can look after. He acts as manager when the manager is absent. The other is almost entirely occupied in carrying on analytical work and calculating the results. He also assists in conducting laboratory tests.

The skilled labor consists of a grinderman, wet machine man and press man. The grinderman operates the pulp grinder and keeps it with its auxiliary

equipment in repair. The wet machine operator keeps in repair the screens and wet machine. The press man removes the pulp from the rolls and assists the wet machine man. These men are also employed in the sawing, barking and preparation of the wood for grinding. All have had practical paper mill experience.

The woods experimented with have been furnished by the American Paper and Pulp Association. The species used up to date are from the Lake States, jack pine, hemlock, tamarack and spruce. The experiments carried on have had as their object the making of a newsprint paper from jack pine or hemlock, or from mixtures of jack pine, hemlock and spruce, which would be satisfactory from the standpoint of color, strength and finish, and which might replace the newsprint made from spruce.

The experiments have been under the supervision of a committee of paper makers who have inspected the work every month. Satisfactory pulp has been made from hemlock and jack pine, and a short time ago a batch of the pulp was sent to a paper mill at Port Edwards where test paper was made of the following seven combinations.

First—An all hemlock sheet of news paper, containing 25 per cent. of hemlock sulphite and 75 per cent. of hemlock ground wood.

Second—A sheet containing 25 per cent. of hemlock sulphite, 25 per cent. of hemlock ground wood, 25 per cent. of jack pine ground wood and 25 per cent. of spruce ground wood.

Third—A sheet containing 25 per cent. hemlock and sulphite and 25 per cent. jack pine ground wood.

Fourth—A sheet containing 25 per cent. hemlock sulphite, 50 per cent. hemlock ground wood and 25 per cent. jack pine ground wood.

Fifth—A sheet containing 25 per cent. sulphite, 25 per cent. spruce ground wood and 50 per cent. hemlock ground wood.

Sixth—A sheet containing 25 per cent. hemlock sulphite and 75 per cent. spruce ground wood.

Seventh—A sheet containing 5 per cent. hemlock sulphite and 95 per cent. spruce ground wood.

Each of the seven different papers was satisfactory though some were better than others. From the results of these experiments it has been concluded that it is possible to make useable and saleable ground wood pulp from hemlock and jack pine, and that mixtures of this pulp with sulphite spruce, make satisfactory newsprint and wrapping papers.

The Wausau laboratory will now undertake the manufacture of ground wood pulp from lodgepole pine, Western hemlock, Western larch, Western yellow pine, white and red fir. The use of these species for ground wood pulp will mean much to the provinces of British Columbia and Alberta.

Experiments in the manufacture of chemical pulp are carried on in the Forest Products Laboratory at Madison, Wisconsin. This is the largest and most complete laboratory of its kind in the world. The building, costing \$100,000, was erected by the University of Wisconsin. The equipment, staff and operating expenses are supplied by the Federal Forest Service. The equipment of the chemical pulp laboratory comprises:—

**Digester, semi-commercial, soda.**—This consists of five nickel-steel castings bolted together; shape, cylindrical with conical ends; capacity 63 gallons.

**Digester, semi-commercial, sulphite.**—This consists of a vessel having two bronze castings at the bottom and a steel lid lined with bronze. The main portion is made of fire-box steel and is provided with a lining of concrete three inches thick. The shape is cylindrical with a conical bottom and flat top; capacity about 60 gallons; built by Freidlander Bros., of Baltimore.

**Blow pits.**—These consist of two cylindrical wooden tanks fitted with false bottoms and removable doors; the size of

each pit is  $4\frac{1}{2}$ -feet in diameter, by 11-feet high. The false bottom of the soda blow pit is made of perforated sheet-iron; that for the sulphite blow pit is of drainer tiles. Each pit is provided with two sprays for washing pulp.

**Spent lye tanks.**—These consist of two 200-gallon sheet-steel tanks; they are fitted with gauge glasses and drain cocks.

**Chipper.**—This is a specially designed machine of the guillotine type. It is capable of cutting up discs 12 inches in diameter and  $\frac{5}{8}$ -inches thick.

**Power press.**—This is a 70-ton Bushnell knuckle joint press.

**Shredder.**—This is a Williams Patent Infant Grinder made by the Williams Grinder and Pulverizer Company of St. Louis.

**Pulp screen.**—This is a six-plate diaphragm screen fitted with flat plates having slots of various widths. It was built by the Sandy Hill Iron and Brass Works, Sandy Hill, New York.

**Paper machine screen.**—This is a two-plate diaphragm screen similar to the six-plate screen above described.

**Riffer.**—This consists of three wooden troughs fitted with dams at frequent intervals.

**Stuff chests.**—These are two wooden tanks fitted with agitators; capacity of each is 300 gallons.

**Drum washers.**—These consist of two wire-covered drums or water extractors, each mounted in a vat holding about 24 cubic feet.

**Beating engine.**—This is of the Hollander type having a wooden tub which has a capacity of about 25 lb. of dry stock.

**Fourdrinier and cylinder paper machine.**—This is a combination machine on which either Fourdrinier or cylinder paper can be made into sheets up to 13 inches wide. It is a complete machine driven by 5 h.p. variable speed motor, and was built by the Pusey and Jones Company of Wilmington, Del.

The laboratory started work in June of this year. The results of the work

have not yet been published, but it is known that a good quality of kraft paper has been manufactured from the saw-mill waste of Western yellow pine; that the sawmill waste of Wisconsin has been found satisfactory for chemical pulp manufacture, that great advances have been made in the manufacture of a good quality of chemical pulp from dead and green tamarack, hemlock and jack pine. The staff at Madison have also examined samples of pulp from practically all the mills in the country, and have worked out satisfactory methods of standardizing, comparing and grading wood pulps.

Similar work has been taken up in India by the Imperial Forest Research Station which is maintained at Dehra Dun by the Indian Forest Service. An experienced paper and pulp man, W. Raitt, has been retained by the Imperial government to investigate the suitability of different Indian woods and grasses for the manufacture of pulp.

The development of the science and technique of pulp and paper making to such an extent that commercial plants will find it possible to support themselves upon the vast quantities of wood waste and of inferior species of woods now annually lost in this country, will require continuous systematic investigation by experts. A certain amount of this work will be done by private individuals, by pulp mill operators and by consulting engineers, but no private individual can afford the time and expense necessary to a thorough study of the whole question. On the other hand, the support of such experiment stations as those at Madison and Wausau, which cost \$25,000 and \$20,000 respectively per year to operate, would be an easy matter for a government, especially if the pulp and paper manufacturers of Canada followed the example of the American Pulp and Paper Manufacturers' Association and assisted to some extent. Certainly every pulp and paper manufacturer in Canada would benefit by any scientific work which would extend the sources of pulp



fibre and improve the processes of manufacture.

A soundly planned, thoroughly executed investigation can best be carried out by the Dominion Government. The first step would be to collect under one organization all the available information bearing on the subject, both in Canada and in foreign countries, to correlate this information and put in such shape as to always be readily available. The branch of the government charged with this work would not only passively distribute information on application, but would also take steps to actively bring to the attention of all private individuals who could benefit by it, any new developments in the manufacture of pulp and paper. This work should be carried on with the full co-operation of scientific men and of practical men engaged in the pulp and paper industry everywhere in Canada.

There are several reasons why this work can best be handled by the government. The government can more readily secure confidential and important trade information than can a private individual. Work carried on by the government would be known to be disinterested and impartial. Valuable results secured by the government would quickly and freely be made available to all persons, and the good results would be more widespread than if the same information had been secured by private individuals. The best work can only be done by a central and permanent organization. Such an organization would be more likely to be developed by the government than by a private individual.

The logical branch of the government to undertake the work would be the Forestry Branch. The Forestry Branch has now a greater knowledge of forest conditions in this country than any other organization in Canada. It has, during the past few years, made special studies of the pulp industry and other wood using industries, and is in touch with all the forest industries of Canada. The

employees of the Forestry Branch have covered the country from the Albany River to the Pacific, and will probably, in the next few years, do much scientific work in Eastern Canada. Work conducted by the Forestry Branch would be conducted solely for the good of the country, for the good of the pulp and paper trade, and to demonstrate that "The human race could increase its welfare almost as much by a better ordering of the consumption as by an increased production of wealth, and this without any retrenchment in consumption."



### EASTERN CANADA POWER AND PULP COMPANY.

Advices from the Lower St. Lawrence state that the \$3,000,000 plant of the Eastern Canada Power & Pulp Co., of Murray Bay, will be completed early in June. The company, which possesses some fine spruce areas about four hundred square miles in extent, was organized by Charles W. Tooke and Marcus E. Stoddard, of Syracuse, with whom was associated, amongst others, Sir Rodolphe Forget. The mills are located five miles from Murray Bay, and the power to be generated will amount to 10,000 horsepower. Mr. Stoddard states that a project has been worked out by which a water reserve has been secured sufficient to run the plant every day of the year, while the timber supply is large enough to last one hundred years. A force of five hundred men have been employed all winter at the plant, but 150 will be regularly employed when it starts operations. The output will be 100 tons of pulp a day. Sir Rodolphe Forget placed most of the stock of the company in England and France. The concern will be a large customer of the Quebec and Saguenay Railway, which has ordered a spur from its main line connecting the mill with deep water at Murray Bay.



# PULP WOOD CONSUMPTION IN CANADA, 1910.

(Continued From March Issue).

**Table 4.**

Pulpwood, 1910, by Provinces, Species and Processes: Number of Mills, Quantity of Pulp Wood Used, Quantity of Pulp Produced, Quantity of Each Species of Wood Used, Quantity Produced by Each Process, Total Cost and Average Cost per Cord.

	Total.	Que bec.	Ontario.	Nova Scotia.	New Brunswick.	British Columbia.
<b>Pulp produced—</b>						
Number .....	51	25	15	6	4	1
Aggregate .. tons.	474,604	282,938	156,076	25,955	9,285	350
Mechanical .. "	370,195	235,889	108,351	25,955	.....	.....
Sulphite .. "	95,987	40,681	47,271	.....	7,685	350
Soda .....	8,422	6,368	454	.....	1,600	...
<b>Wood used—</b>						
Aggregate cords.	598,487	342,755	210,552	29,606	15,134	440
Aggregate cost ... \$	\$3,585,154	\$1,879,831	\$1,479,538	\$135,965	\$87,620	\$2,200
Average cost .... \$	6.00	5.48	7.02	4.59	5.79	5.00
<b>Spruce—</b>						
Total .....	470,230	239,824	189,196	25,636	15,134	440
Total cost .....	\$2,846,678	\$1,310,428	\$1,326,275	\$120,155	\$87,620	\$2,200
Average cost .....	6.05	5.47	7.01	4.68	5.79	5.00
Mechanical .. cords.	323,350	188,905	108,809	25,636	.....	.....
Sulphite .....	134,959	80,387	41,998	.....	12,134	440
Soda .....	11,921	8,921	.....	.....	3,000	...
<b>Balsam—</b>						
Total .....	120,475	96,474	20,256	3,745	.....	.....
Total cost .....	\$ 698,608	\$ 537,485	\$ 146,388	\$ 14,735	.....	.....
Average cost .....	5.71	5.57	7.22	3.94	.....	.....
Mechanical .. cords.	64,377	53,848	6,784	3,745	.....	.....
Sulphite .....	56,098	42,626	13,472	.....	.....	.....
Soda .....	.....	.....	.....	.....	.....	.....
<b>Hemlock—</b>						
Total .....	3,816	3,616	.....	200	.....	.....
Total cost .....	\$ 16,922	\$ 15,922	.....	\$ 1,000	.....	.....
Average cost .....	4.43	4.40	.....	5.00	.....	.....
Mechanical .. cords.	600	400	.....	200	.....	.....
Sulphite .....	.....	.....	.....	.....	.....	.....
Soda .....	3,216	3,216	.....	.....	.....	.....
<b>Poplar—</b>						
Total .....	3,608	2,483	1,100	25	.....	.....
Total cost .....	\$ 21,366	\$ 14,416	\$ 6,875	\$ 75	.....	.....
Average cost .....	5.92	5.80	6.25	3.00	.....	.....
Mechanical .. cords.	25	.....	.....	25	.....	.....
Sulphite .....	1,800	1,800	.....	.....	.....	.....
Soda .....	1,783	683	1,100	.....	.....	.....

Others—				
Total	..... cords.	358	358	.....
Total cost	..... \$	1,580	\$ 1,580	.....
Average cost	..... \$	4.42	\$ 4.42	.....
Mechanical	..... cords.	209	209	.....
Sulphite	..... “	.....	.....	.....
Soda	..... “	149	149	.....

Table 5.

Export of Wood-pulp, 1909 and 1910: Quantity, Value and Chief Countries Importing.

Kind of Pulp and Countries to which Exported.	1909.		1910.	
	Quantity. Tons.	Value. \$	Quantity. Tons.	Value. \$
Wood pulp exported, aggregate .....	280,744	4,898,842	328,977	5,694,896
Total mechanical pulp .....	241,750	3,378,225	288,807	4,234,705
Total chemical pulp .....	38,994	1,520,617	40,170	1,460,191
Mechanical pulp:—				
To United States .....	154,179	2,482,221	214,469	3,450,831
To United Kingdom .....	78,510	805,519	62,103	657,183
To other countries .....	9,061	90,485	12,235	126,691
Chemical pulp:—				
To United States .....	37,336	1,459,340	39,947	1,451,068
To United Kingdom .....	1,049	42,007	178	7,398
To other countries <sup>1</sup> .....	609	19,270	45	1,725

(1) Includes the following countries given in their order of importance:— France, Belgium, Mexico, Australia, Cuba and Japan.

Although pulpwood production was less in Canada during 1910 than during the year previous, exportations of wood-pulp were increased by 48,233 tons. Wood-pulp exportations amounted in 1910 to 69.3 per cent. of the total amount produced in Canada, whereas in 1909 it was only 63 per cent. Of the 328,977 tons of wood-pulp exported, 288,807 tons, or 87.8 per cent., was mechanical pulp, which is a little greater percentage than in 1909. Only 78 per cent. of the pulp manufactured in Canada was mechanically prepared. While the increase in export for 1910 consisted of mechanical pulp, 1,173 tons more of chemical pulp were exported in 1910 than during 1909. The 40,170 tons of chemical pulp shipped made up 12.2 per cent. of the total export.

The average value per ton of the pulp exported in 1909 was \$14.67 for the mechanical, and \$36.35 for the chemical

pulp. This is an increase over the 1909 price of 70 cents for the mechanical, and a decrease of \$2.64 for the chemical pulp. The average price for all pulp-wood exported was \$17.31, or 14 cents less per ton than the previous year's price. The prices per ton paid to Canadian exporters by the different importing countries were as follows for mechanical pulp: United States, \$16.09 (exactly the same as in 1909); United Kingdom, \$15.78 (\$5.52 more than in 1909); other countries, \$10.35 (37 cents more than in 1909). For chemical pulp: United States, \$36.32; United Kingdom, \$41.60; other countries, \$38.30.

During 1910, over three-quarters of the wood-pulp exported went to the United States. This country took 74.3 per cent. of the mechanical pulp and over 99 per cent. of the chemical pulp exported from Canada in 1910. Except for an increase of 3,000 tons of mechanical pulp to

small transatlantic countries, export to other countries decreased. The export of chemical pulp to the United Kingdom has fallen off from 7,519 tons in 1908 to 178 tons (not one-fortieth as much) in 1910. The mechanical pulp shipped to the British Isles also decreased by 16,047

tons during 1910. The United Kingdom received in 1909, 32.5 per cent. of the mechanical pulp exported from Canada, while in 1910, only 21.5 per cent. of the amount exported was used in those countries.

**Table 6.**

Canadian Pulpwood Exported Unmanufactured vs. that Manufactured in Canada, 1909 and 1910: Quantity, Value and Per Cent. Distribution.

	1909.			1910		
	Quantity. Cords.	Value. \$	Per Cent.	Quantity. Cords.	Value. \$	Per Cent.
Pulpwood produced in Canada.	1,537,762	9,216,739	100	1,541,628	9,795,196	100
Manufactured in Canada . . . . .	622,129	3,464,080	40.5	598,487	3,585,154	38.8
Exported in raw state . . . . .	915,633	5,752,659	59.5	943,141	6,210,042	61.2

In 1910, only some 4,000 cords more wood were cut for pulp in Canada than in 1909. Of the 1910 amount of 1,541,628 cords, 23,642 cords less were manufactured in Canada than in 1909, and 27,508 cords more were exported. This gradual

change is not so noticeable in the comparative percentages, but even here it may be seen that Canada is increasing the proportion of her natural resources exported in the raw state.



### ONLY SMALL SAVING BY "LOAD-INC" PAPER.

The paper manufacturer does not make an appreciable saving in the use of fillers unless they are added in comparatively large quantities, says H. P. Carruth, of Arthur D. Little, Inc. Let us suppose that in a wood paper the pulp costs \$45 per ton, and the clay \$15. (The cost of fillers ranges from 40 cents to \$1 per 100 lbs.) To obtain 10 per cent. in the paper 20 per cent. of clay must be used (since the fibre retains only half, or less of the added filler), and the cost per ton of paper would be \$42.50 for pulp and clay, showing an apparent saving due to the use of clay of \$2.50 per ton. The real saving, however, is less than this, as there are some other factors to be considered. Clay or any filler tends to reduce the strength of paper. It would, therefore, be necessary to use a slightly

better grade of pulp to offset this loss; again, it is necessary to increase the amount of size in a paper containing filler; this would add to the expense. There are also other factors such as the extra expense for preparing the filler, extra wear on the paper machine, etc. From all this, it is evident that small additions of fillers are not greatly to the financial advantage of the manufacturer, and he is therefore unlikely to resort to them unless they offer some other advantage.



—Walter B. Snow, Publicity Engineer, 170 Summer Street, Boston, has increased his organization by the addition of Mr. Charles L. Mulligan, late of the editorial staff of the Brooklyn Standard Union, and for a considerable period associated with the publicity department of the Western Electric Company.

## TREATMENT OF FIBRE YIELDING MATERIALS.

A patent has been granted by the United States Patent Office to C. F. Sammet and J. L. Merrill, for an improved process for treating fibre-yielding materials, with especial reference to wood pulp for the manufacture of paper. Experiments along this line have only been made with spruce wood, as this is the material from which there is the most complaint, as it is that most generally in use for this purpose, but the suggestion has been made by practical paper men who have seen the process and are enthusiastic in its praise that it should be extended to other classes of woods, with the hope that correspondingly satisfactory results may be obtained, and it is the intention of the inventors to do this at a later date.

The object of the process is to manufacture sulphite fibre in such a manner that the resulting waste liquid will be much less in volume than by the ordinary process, and relates to the treatment of fibre-yielding materials, such as wood, flax, bagasse, straw, etc. The magnitude of the sulphite waste annoyance and the increasing agitation caused thereby is evidenced by the great number of legal actions which have arisen for years past, and with ever increasing frequency. In many sections this nuisance is prohibited or placed under strict legal control. In the United States there are few sulphite mills which have not received complaints from private parties, corporations or municipal authorities with this regard to the discharging of sulphite waste into the water courses.

Of all the methods proposed for disposing of or utilization of this waste, not one has been so perfected that it has found any extended application. The great majority fail or are greatly handicapped by the great amount of water associated with the waste. Many methods which remove the sulphurous acid from the waste by condensation, etc.,

are merely temporary reliefs, and in time will come under legal censure for discharging organic matter into the water courses.

It is thus evident that any process that produces a small volume of waste per ton of fibre is a great stride toward the solution of this problem, and this is the claim for the process set forth in this patent.

For this process actual cooking conditions are obtained in about one-half an hour after the steam is admitted. This effects a great saving of cost and time, and this is due to the fact that there is little liquid in the digester which has to be brought up to temperature. The only liquid resulting from the cooking is that due to the condensation of the steam, which percolating through the pipes removes a very large part of the lyeous matter which has been rendered soluble. This condensed water approximates 6,000 gallons, and this effects a saving of about 25,000 gallons of liquid on a 10-ton digester.

This great reduction means much to many of the disposal or utilization processes where the utilization of the waste is a serious drawback, which processes include evaporating, or, evaporating and burning, drying for tanning purposes, alcohol manufacture, briquette binder, heat value, cattle fodder, paper sizing products, sulphur recovery, dye and mordant products, etc.

Another great advantage of this process is that the resultant stock is not only very light in color but has exceptionally great strength. Experts who have seen the fibre are unanimous in their recognition of this feature. Hand made water loft sheets, without calendering or sizing, have shown strength features of from 1 to 1.5 per cent., thus placing it on a par with the best imported kraft papers; and it is interesting to note that this is the highest strength

test which has ever been obtained either here or abroad.

In regard to the chemical consumption no absolute figures have, as yet, been obtained, but it seems very evident from the work thus far accomplished that the chemical cost will very probably be something less than by the ordinary processes.

The yield of fibre has not yet been determined, but from the nature of the fibre it is very probable that the yield will be high. On account of the promising results thus far obtained, the work will be further continued, and on a much larger scale.

It must be understood that the work is, as yet, merely in an experimental stage. In looking at this problem to see whether there is anything in it or not of a commercial value, there are a number of features that must be taken into consideration; for instance, suppose it costs the same to manufacture, if it gets rid of this pollution annoyance, and if the strength of the fibre is equally as great—that, of course, is a gain.

What can be obtained from the resultant waste is not a feature that can, as yet, be determined. The effect, so far, has been to get it in such small amounts that it can be easily disposed of, and this will lead up, in due time, to the question of the recovery of the chemicals from that waste, and in this connection it must be remembered that the inventors feel confident that the consumption of chemicals will be less than by any of the heretofore known processes.

To sum up briefly:—

Less steam is required. The steam that is saved is the steam required to heat up 26,000 gallons of saved liquid.

The pressure is lower; the cooking has been done very successfully in this process under 50 pounds pressure, as compared with the 75 pounds required under present processes.

Another point is that the cooking starts within one-half hour after the temperature is reached; whereas, under ordinary circumstances cooking does

not take place until about four hours. By the usual process the cooking requires about eight hours; under this proposed method successful cookings have been made in from five to six hours. The fibre is usually as white and possibly a better color than by the ordinary process.

Possibly 100 different chemicals were tested before this combination was discovered, and this large number of compounds was taken to get an idea of the chemical effects upon which this cooking is based; free ammonia, sulphur dioxide and steam was finally found to yield the desired results.

The specifications and description of the patent are given by the inventors, Charles Frank Sammet and Jason Leslie Merrill, of the Department of Agriculture, Washington, D.C., and have been placed at the service of the Government without royalty.

The object of our invention is to provide a process for treating cellulose containing materials by subjecting them to the action of a chemical or chemicals in a gaseous or vaporous condition or medium at ordinary or elevated temperatures or pressures, thus dispensing with the necessity of subjecting the material to the action of chemicals in a solution, as is done by known processes.

Another essential object accomplished by our process is the shortening of the time required in treating the materials. The time of treatment is reduced due to the more rapid penetration and action of chemicals in gaseous or vaporous state or medium. A further result is attained by the lessening of the smaller volume of liquid required to be heated in this process.

The essential advantage of our process is in the small volume of waste liquor produced. In previous processes the by-products are removed in the large volume of cooking solution used, while in our process the products are removed by the small volume of liquor resulting from the condensation of the vapors. The small quantity of waste liquor produced



makes the disposal or utilization of the same much more feasible.

In practising this process, the fibrous material is cut into pieces of appropriate size and then placed in a digesting vessel of any modern type of construction. After which operation the material is then subjected to the action of gases or vapors, i. e., sulphur dioxid, ammonia and steam, under any suitable pressure, preferably from 25 pounds to 125 pounds, and at any suitable temperature, preferably from 125° to 160°. The temperature and pressure within the digester are regarded and regulated and controlled in the usual manner. The gases and vapors are introduced into the digester for action on the material through pipes connected to the digester from tanks, where such gases or vapors are under pressure exceeding those maintained in the digester, said latter pressure being obtained by the use of pumps or by liquids or solutions which evolve gases or vapors, such as an ammonium sulphite solution. We employ free ammonia and ammonia sulphite at the same time in carrying out the process herein disclosed.

The concentration of the chemicals in the digester are regulated and maintained by the quantities introduced therein either continually or intermittently during the process. The vapors condensed within the digester and containing part or all of the products from the chemical action of the material treated may be removed therefrom either continuously or at intervals by the aid of a suitable relief valve attached to the digester. After the material has been subjected to the process herein described for such a period that it becomes readily disintegrated by slight mechanical action, the operation is complete, and the material is then in condition to be removed from the digester.



#### FILLING UP THE FELTS.

---

Clay causes felts to fill up quicker than any other material used in the manufacture of paper. In mills where it is

used largely the felts run less than twenty-four hours, when they must be washed. In fine mills or mills making fine grades of writing paper, the felts used in making the paper run a week without washing. Of course, the moisture of the paper as it passes on to the felts affects the cleanliness of the felt, and where it is customary to have as little wire marks on under surface of sheet, by using no weights on couch roll levers and heavy weights on felt levers, the felts fill up very quickly. The weave of the felt is of great importance. Close woven heavy felts fill up more quickly than do open weave and light weight felts. Size is another factor which has influence in this matter, and the greater the quantity of size used the harder it becomes to keep the felts clean. The size causes the felt to become sticky, and when in this condition it becomes coated with fibres taken from the surface of the paper which runs on it. Paper composed of very short fibres will fill a felt more quickly than will a paper made from long fibres. The shorter fibres will become embedded in the weave of the felt, while the long ones are more difficult to take from the surface of the sheet. The thicker the paper the worse is the effect upon the felt, for when running this class of paper it is subject to more work. Often a new felt becomes filled owing to carelessness of the machine tender, who uses very poor judgment in placing weights upon the press levers, sometimes putting most of the work of extracting water from paper upon a new felt. The cause of a felt filling up in one particular part is usually found in the press rolls not being true, or either in the couch rolls, where one place in the roll does not press as much water from the sheet as does the remainder of the rolls. Old felts or felts which have been used more than once, often fill up, because they are not properly washed after being taken from the machine and are placed on again in an unclean condition; they fill very quickly and cannot be washed satisfactorily on the machine.

## PULP INDUSTRY IN BRITISH COLUMBIA.

Hon. P. Ellison, in introducing his budget in the British Columbia Legislature, said:—The supply of pulpwood in the eastern United States has been hopelessly insufficient for the present needs of their people, and they already import one-quarter of the whole of the raw material for their paper mills from Canada. We are also exporting to them \$4,000,000 worth of manufactured pulp for the paper mills of the eastern states.

I look forward to a rapid growth in that industry. I may add that the completion of the Panama canal in 18 months time cannot but have enormous influence in the development of our lumber trade. It can hardly fail in fact to become by far the most profitable of our staple industries. The cheaper freight rates, which will necessarily accompany the opening of the canal, must give an unprecedented stimulus, and will at the same time prevent a recurrence of periods of depression. With an easy means of communication secured to us by water as well as by land the depletion of the world's timber in other regions cannot fail to make the timber output of our forest lands a most permanent source of revenue for generations to come.

This province more than two years ago outstripped Quebec in the production of lumber, while in 1910 her output was on a par with that of Ontario. It does not require the eye of a prophet to see that, with a vast proportion of her virgin forests still untouched, she will, in proportion to her size, take a prominent place within a year or two among the great timber producing countries in the world.

In order to bring about this end and to encourage the establishment of the paper making industry in the province the government granted in 1901, 21 year leases of pulp wood forests to companies on liberal terms. In 1903 the law granting pulp leases was repealed. The an-

nual rental now paid under these leases is two cents per acre and a royalty of 25 cents per cord of pulp wood cut. Four companies are now either erecting or operating plants, the British Canadian Wood Pulp & Paper Co., the Swanson Bay Forests Wood Pulp & Lumber Mills, the Ocean Falls Co., Bella Coola, and the Powell River Paper Co. As a proof of the prosperity of the industry the last named company is filled up with orders for all the paper and pulp it can produce.

I believe that the mills of Powell River, Swanson Bay, Howe Sound and those of the British Columbia Wood Pulp & Paper Co., vast as they are, are but the pioneers of an enterprise which will fling its tentacles all over the world.

Looking forward into the centuries, one can imagine a time when the great forests of this province will be denuded of most of their timber; but even then, if all the wealth were gone, British Columbia would remain the greatest producing region in the world. No country shares with us our climate or our soil. It is the most congenial for the cottonwood, spruce, balsam, hemlock, and Lombard poplar, which produce the best paper. Already our ships are conveying the output of our forests in pulp and paper to Australia, New Zealand and the Orient, and no far sighted man can doubt that in the near future half of the whole world will be the market place of the pulp and paper produce of British Columbia.

We have in this province a combination of the three factors which together insure the prosperity of the pulp and paper trade—factors without which the industry can nowhere be successfully maintained. These three factors are (1) cheap water power; (2) cheap timber; (3) cheap transportation in close juxtaposition. Washington, Oregon and California have the last two but they lack that most essential factor—cheap water power. My conviction is therefore, that we can always compete successfully against other producing countries in capturing the pulp trade.

# FUNCTION OF STARCH IN PAPER

By J. Traquair.

(Continued from last issue.)

The effect of adding a quantity of swollen or partly swollen starch to the pulp is the coating of the fibres with gelatinous starch hydrate. This adds a wetness or increased capacity for holding water, and as the water is longer retained in the passage of the pulp over the wire, the thorough interlacing of the fibre by the "shake" is assured. Under the action of the press rolls the interlocking of the fibre is favored by the presence of a gelatinous substance which may be regarded as a kind of cement, and in the final drying the shrinkage of the now thoroughly swollen gelatinous starch, which accompanies dehydration, considerably helps the process of compacting the sheet. It is this effect which justifies the use of starch, and although it can be obtained by prolonged beating and consequent hydration of the cellulose, it is more economically obtained by starch.

The makers of tub-sized papers have always viewed with suspicion any starch product which has been offered as a substitute for gelatine. The fact seems to have been entirely overlooked that the earliest papers were exclusively starch-sized, and as far as sizing and durability are concerned, are still unsurpassed.

All efforts to substitute a pure vegetable size for gelatine have ended in failure, and this fact has established the use of gelatine so firmly that tub-sizing has come to mean animal tub-sizing, and is frequently guaranteed as such. The advantage of feculose over animal size is that it can be dried at a high temperature, and, therefore, more quickly; and the elaborate air-drying methods at present in vogue (and necessarily where gelatine is used) can be largely dispensed with. No starch product, however, has the ink-resisting power of gelatine, but this can be easily obviated by adding a little resin size to feculose solution, and then just sufficient sulphate of alu-

mina to decompose it. From one-fifth per cent. of rosin size may be used, and this gives the ink-resisting quality. The feculose solution is distinctly colloidal in character, and does not penetrate the paper so readily as animal size. Comparative tests have shown that when used alone without alum, the paper takes up the same amount of size from a six per cent. solution of gelatine as from a twelve per cent. solution of feculose at 90 deg. F. Experiments run under these conditions on a paper making machine, where the half-dried paper was run through the tub-sizing box, then over three-sparred cylinders, followed by ordinary cylinders and calenders, which dried and finished the paper in one operation, gave excellent results, the paper being in every way equal to that obtained by sizing with gelatine.

The fact that feculose does not give tannic acid reaction has led to its use in conjunction with gelatine. This has opened quite a new field, and feculose is now in regular use in several works for sub-sizing paper. So far its use has been confined to the cheaper class of machine made tub-sized paper, the makers of the higher class tub-sized papers being naturally very conservative. Feculose shows a 30 to 40 per cent. economy over gelatine, but the works where the gelatine is extracted directly the difference is less.

A typical sizing bath is two parts twelve and one-half per cent. solution of feculose and one part of six and one-half per cent. solution of gelatine with just sufficient alum to give the required viscosity to the size. It has been found that feculose gives the paper a distinct quality, improving the handle by making it more pliable, and the writing quality by making the surface less hard and ink-repellant.

Feculose is also used to improve engine-sized writing where the paper (which

nas been fully resin-sized in the beater), when more than half dry, is run through a weak solution of feculose and dried on the paper making machine. The paper is tightly squeezed, so that little size is taken up, and it is endeavored to keep this size as much as possible on the surface. This imparts the handle and writing quality of a tub-sized writing, and leads to new outlets for this class of paper.

In paper of this class the production of a good printing surface is the ultimate criterion of success. Feculose and china clay have been used in weak solution on the water doctor calender with very promising results, but the conditions are rather difficult to adjust, and this use is at present in the experimental stage. Where the paper is tub-sized in feculose and color the conditions are more easily controlled, and encouraging results are obtained, the important point being that the loading is put where it is more required, viz., on the surface of the paper. Of course, under ordinary working conditions you are limited to a very light coat, but the result is an improved printing surface, and the full value of every ounce of sizing material used is obtained on the paper. The china clay can be replaced by other colors, such as blanc fixe or satin white, with superior results, and, as this paper has received what we may term a preliminary coating, a much lighter, finer coat would be required if used as an enamelling paper. This opens a wide field of possibility, as the coating method could be simplified, and the speed of coating greatly accelerated. The problem before paper-makers to-day is the production of a printing surface which will take a process block at a price as near that of ordinary printings as possible. I feel sure that the solutions will be found on the lines I have indicated, but our experiments have not reached such a stage as to warrant a definite statement, although I will deal further with this under paper coating, where positive results have been obtained.

This is a distinct branch of the paper trade, and, in fact, forms a separate industry. The function of size in this case is to fix the mineral coating to the surface of the paper.

Few can have failed to notice in the last decade the enormous growth in numbers and circulation of illustrated papers. The better class periodicals have cultivated a popular taste for good illustrations, and now no book or magazine is acceptable without them.

The development of modern printing paper is closely associated with the introduction of the photo-mechanical processes of illustrating. The application of photography and the designer's art to commercial purposes in the numerous monthly, weekly and even daily papers, not to mention the numberless advertising pamphlets, catalogues, etc., has created a large and ever increasing demand for a cheap paper, to give the most effective printing results. The wood engraving, the copper etching, the colotype, the lithograph, and the half-tone process block have each marked a stage in the advancement of the printer's art, and each required some special characteristic in the paper to obtain the best results. In the modern half-tone block and three-color process work a paper having a smooth surface is essential, if a picture showing a sufficient amount of detail is to be produced. This smoothness of surface in the case of imitation art is secured by loading the paper heavily with china clay and water, finishing on hot calenders, but if one will compare a picture printed on the same block on imitation art and on ordinary art enamel, it is evident why the former is called "imitation" art enamel. The picture in the former is very much inferior in depth and clearness—in fact, has a gray appearance.

It must be pointed out that the degree of surface smoothness should only be sufficient to take the maximum of details possible in a process block, and the ideal position is arrived at when a paper with a surface just sufficiently perfect to take



the maximum of detail possible is produced.

It must be confessed that the heavy art enamel which has been produced in response to the insistent but often unreasonable demand for something cheap, is not really paper. It is generally a sheet of poor vegetable fibres sandwiched between two coats of mineral matter, which frequently amounts to 50 per cent. of the whole.

The coating performs two functions: In the first place, it fills up and levels up the unevenness of the paper, and secondly, it provides a printing surface. This is an important point, and one that is generally overlooked by the paper manufacturers. It is the printing surface which is the essential condition. An imitation art enamel may have a perfectly smooth surface and still give printing results very much inferior to a third or fourth class coated paper. The reason is that the surface has no ink affinity—that is, it has no power of absorbing the ink from the block in the fraction of a second in which they are on contact; in fact, the surface is ink resistant, instead of being ink absorbent. The ideal coating for paper would be solution of cellulose, but up to the present, although a number of attempts have been made, these have not proved successful. The manufacture of art enamel has been dealt with in a paper read before this society by R. W. Sindall, and I propose to confine my remarks to amplifying various points which were only briefly dealt with in his paper, and to deal especially with the application of starch, notably the starch ester or acetate feculose.

At first paper coating was all done by hand, the earliest machines being of the flat type, with round spreading brushes, which have a circular motion. In the early eighties the German cylinder machine was introduced with jigger brushes, and this has remained the standard type until the present day, although with a number of minor improvements. Some of

the large art enamel firms have double coaters, but these are not completely successful, as the trouble of adjusting them scarcely compensates for the increased speed of production.

The paper used varies considerably, the test being pure esparto paper, then mixtures of esparto with chemical wood pulp in various proportions. In the cheaper qualities mechanical wood pulp is used in increasing proportions. The pulp should be free beaten, and the paper as free from wire mark as possible and little more than half resin-sized. For good class chromos, it is essential that good quality body paper be used, as this has a greater influence on the printing results than is generally credited. The colors used are of some interest.



In the matter of the assignment of the Northern Islands Pulpwood Co., Ltd., Port Arthur and Windsor, Ont., a meeting of creditors was held in the office of the assignees, E. R. C. Clarkson & Sons, Toronto, on the 15th ult. It was decided to continue operations in order to bring a large quantity of pulpwood to market. Representatives of the chief creditors, viz., the Detroit Sulphite Pulp and Paper Co., Imperial Bank of Canada, Davidson & Hay, Park, Blackwell & Co., and Nelson & Dowler, were appointed inspectors, with power to continue operations, and, in conjunction with the assignee, to dispose of the assets and wind up the estate. The assets are for the present stated as \$291,540, and the liabilities, \$214,874, the nominal surplus being \$76,666. The company has been engaged in pulpwood operations on the north shore of Lake Superior for four years, with the head office at Port Arthur, and W. H. Russell of that city as president. Much of the stock is held in Port Arthur district. The trade has been largely in exporting pulp to the United States, and the assets, estimated at \$400,000, comprise a Port Arthur plant and timber-cutting rights over a large area.



## ALUM FOR SIZING.

In the market there are four kinds of alums, known as sulphate of alumina. says Papeterie. These may be divided into the following classes: alum, with a potash base or double sulphate of aluminum and potash; alum with an ammoniacal base, or double sulphate of aluminum and ammonia; finally, concentrated alum, or simple aluminum sulphate. The first mentioned salt contains about 10 per cent. of alum, the second 11 per cent., the third 15.5 per cent. It is consequently the latter that has most interest for papermakers. It is composed of sulphuric acid (anhydrous, about 36 per cent.), aluminum in the proportion above indicated, and 48.5 per cent. of water.

It is needless to state that this composition is the theoretical normal composition which good alums should have. As a fact we do not always find it in trade: here, as elsewhere, there may be defects of manufacture, even fraud, rare, however, and without cause, on account of the low price of this substance.

The value of alum depends on the quantity of aluminum which it contains; on its acid reaction, chiefly the absence of uncombined sulphuric acid, and on the amount of iron it contains.

As regards the influence of each of these factors on sizing, we shall consider first of all the quantity of aluminum. It is the aluminum alone which by combining with rosin forms an insoluble compound, impervious, enveloping the fibres of the pulp, forming for them a coating which constitutes the sizing of the paper. It is needless to emphasize the importance of this factor.

The question of acidity possesses hardly less significance. In taking account of it, it is well to consider what are the reactions that take place during sizing and what they produce. Two substances are found present, or to speak more exactly, two compounds: rosin

soap, or sodium resinate, a chemical combination of rosin with soda and alum or aluminum sulphate. As a result of their contact, the acid portion of the alum separates from the aluminum, combines with the soda of the soap and forms with it sodium sulphate. The aluminum, thus set free, associates itself in turn with the rosin, likewise set free, and forms with it, aluminum resinate. The latter is insoluble; it is therefore impervious and this is the real factor in sizing. If each of these four substances occurs in such proportions as to be completely absorbed in the foregoing combinations it is evident that the process has been perfectly effected. But as a rule the aluminum sulphate of commerce is impure; it contains uncombined sulphuric acid in excess of that combined with the aluminum. Under these circumstances, which are no longer those that we have just considered, what takes place?

It is first of all the free sulphuric acid that acts by uniting with a portion of the soda of the soap to form sodium sulphate in such a manner that a certain quantity of rosin is set free. This is then superfluous; it cannot enter into the aluminum resinate combination in the desired proportions and it remains in suspension in the stuff, without being of any use in the sizing. On the other hand, it is very objectionable in the course of manufacture, choking the meshes of the wire and of the felts and sticking to the driers, to the detriment of the cleanliness of the sheet of paper.

But this is not all; it frequently happens that in bleaching in mills where they make use of sulphuric acid, the latter has been used to excess; subsequent washings have failed to fully free the pulp from it.

Fortunately the evil is much less objectionable in practice and that without our doing anything to remedy it. In

reality the remedy is provided, either by nature itself, or by the rosin soap by its own working. In the first place it is because the waters used are almost always impregnated, more or less with carbonate of lime—but also because the alum must be put in the beater a sufficient time before the soap so that the acid acts on the lime before coming in contact with the soda. In the second instance, it is because the rosin soap contains an excess of soda not combined with the rosin, and which is well adapted to receive the first attack of the free acid. It can be seen that in either case, there is a neutralization, more or less extensive, of this free acid and a reduction of its objectionable effect.

It is true, we run a risk of falling into the opposite extreme; that the welcome lime or free soda will be present in excessive amounts and will become harmful; once having utilized the portion necessary for the neutralization of the free acid, there will remain a surplus which, contrary to what has just been stated, will unite with the acid of the alum, and this will remain in turn free without entering into combination with the rosin so necessary to effect the sizing. The stuff will then contain precipitated alum, which will no longer be satisfied with being useless in the sizing; it may have a bad effect on the coloring of the paper.

It will be seen from what has been stated how much depends on knowing the character of the water we are using, for the quantity of alum to be added to the rosin soap is dependent on the amount of lime or soda set at liberty one way or another in the water in the beater.

The surface of the solutions of rosin soap should be carefully skimmed after they have cooled; for a brownish foam composed in large part of free soda forms on the surface. It is moreover for this reason advisable sometimes to allow the resinous soap to "season" before dissolving it; the free soda rises to the surface and can readily be removed.

## NEW INCORPORATIONS.

The O. P. McGregor Paper Company, Ltd., Toronto; capital, \$40,000. To make and deal in paper, box board, pails, bags, envelopes, calendars, labels, etc.; do business as publishers, stationers, envelope manufacturers, book-binders, etc. O. P. McGregor, manufacturer; Wm. Morgan, salesman, D. Arnot, contractor, and J. W. Gale, traveler, all of Toronto.

Litho-Print, Ltd., Toronto; capital, \$100,000. To carry on a lithographing and printing business. A. V. Lewis, manufacturer; G. A. Arlow, salesman, of Toronto.

Labor News Publishing Company, Hamilton, Ont.; capital, \$5,000. To print and publish a newspaper. S. L. Landers, editor, Hamilton.

Newport Sawmills, Ltd., Newport, B.C.; capital, \$50,000. To carry on a lumber, pulp and paper manufacturing business.

The A. L. Olts Company, Ltd., Vancouver; capital, \$100,000. To do business as sawmill, shingle mill and pulp mill proprietors.

Sullivan Bros. and Hiland, Ltd., New Westminster, B.C.; capital, \$300,000. To import, export, prepare for market and deal in lumber, pulp and paper of all kinds. T. J., H. B. and J. B. Sullivan and T. E. Hiland, New Westminster.

Joseph Fortier, Ltd., Montreal; capital, \$100,000. To carry on the business of Joseph Fortier, as merchant, paper manufacturer and dealer in office specialties, printer and book-binder. Jos. Fortier; E. Lalonde, manager; J. W. Butler, printer, all of Montreal.



—H. R. MacMillan, of the Forestry Bureau, Ottawa, last month gave a very interesting address before a large number of Toronto forestry students and others, describing the steps which had been taken for the development and protection from fire of the Dominion Forest Reserves.

## PULP AND PAPER NEWS.

C. V. Syrett, manager of the Victoria Paper and Twine Co., Toronto, has been ill with typhoid fever at St. Michael's Hospital.

\* \* \*

The St. John Pulp & Paper Co. hope to start the inspection mill again by August or September, but their plans at present are somewhat indefinite.

\* \* \*

The D. S. Perrin Co.'s biscuit factory at London, Ont., recently burned, will be rebuilt on an enlarged scale, and it is said that it will have a paper box making plant.

\* \* \*

The Algoma Commercial Co.'s woods and lumbering department will be taken over by the Lake Superior Paper Co. About 60,000 cords of pulpwood are expected to be taken out. H. Dennison, superintendent, will continue in charge.

\* \* \*

In the case of British-American Wax Paper Co., Toronto, vs. Shortiss, to restrain defendant from infringing plaintiff's patent, the defendant was ordered to keep an account of all the output by the machine, and the motion was enlarged to hearing.

\* \* \*

A by-law has been carried at Sherbrooke, Que., granting free site and exemption from taxes to the Sherbrooke Iron Works Co. The firm manufactures paper machinery and general iron works. Tenders will be called later for construction work. Estimated cost, \$35,000.

\* \* \*

It is understood that satisfactory arrangements have been concluded between Mr. Backus, president, and R. J. Young, manager, of the Minnesota and Ontario Power Co., and the town of Fort Frances, Ont., and that now the long delayed work of building pulp and paper mills to cost \$1,000,000 and employ 500 men, will speedily be in full progress.

The Belgo-Canadian Pulp and Paper Co., Ltd., will shortly remove their sales department office from Montreal to Shawinigan Falls.

\* \* \*

The British Columbia Sulphite Fibre Co. has completed the construction of a sulphite pulp and paper mill on Howe Sound, with a capacity of 50 tons daily.

\* \* \*

The Wayagamack Pulp and Paper Co., Three Rivers, now have on hand all the machinery required for the paper mill and they expect to begin manufacturing paper early in June.

\* \* \*

A new company has been organized under the name of the Victoria Paper Goods Co., R. T. Guild, manager; offices and factory, 80 Colborne St., Toronto. They will make paper specialties of all kinds, paper covers and paper bags.

\* \* \*

The Brompton Pulp and Paper Co. has just purchased about 5,000 acres of timber limits near Lambton, Que., from L. S. Roberge, the price being about \$60,000. This company's new pulp mill extension at East Angus, Que., started operations a week or two ago.

\* \* \*

The Partington Pulp and Paper Co. has been granted by the municipal council a fixed assessment of \$225,000 for fifteen years, on its property at Lancaster, N.B., provided that \$100,000 be spent within two years, 50 more hands engaged, and eventually a paper mill be built.

\* \* \*

Some of the lumber and pulp and paper mill men in British Columbia are petitioning the Provincial Government to allow the export of pulpwood cut on Crown lands, in order to obtain duty-free access for paper to the States, though no wood would actually be exported.

Sault Ste. Marie, Ont., has passed a by-law to exempt the Lake Superior Paper Co. from taxation. Construction work on the additional sulphite plant and on the improvement of the ground wood mill is going on rapidly. The capacity of the newsprint mill will be doubled.

\* \* \*

The Dominion Envelope Co. are now using a single side seam machine of their own manufacture which turns out 12,000 envelopes an hour and prints 2 sides 2 colors, all in one operation. They have opened a branch office in London, England (58 Southwark St. S.E.), under the name of The National Envelope Co., who are handling these envelopes.

\* \* \*

A. E. Reed & Co., Ltd., Bishop's Falls, Nfld., will shortly have their additional equipment in operation, when the maximum capacity of the plant will be 144 tons of ground wool pulp per day. The plant comprises 18 grinders, 6 pairs of waterwheels for grinding and 1 pair for electric power, 7 horizontal centrifugal screens, 8 wet machines, and refiner. Plans were made by Geo. F. Hardy, New York.

\* \* \*

W. J. Gage, of W. J. Gage & Co., Toronto, and president of the Kinleith Paper Co., who has already shown his generous interest in the cause of eradicating that dread disease, consumption, has again shown his liberality towards the Weston Sanitarium for Consumptives, by a donation of \$60,000 for the erection of a children's cottage, to take the place of the building destroyed by fire some months ago.

\* \* \*

Dr. B. E. Fernow, head of the faculty of forestry of Toronto University, is about to survey 1,000 square miles of waste lands in Eastern Canada, principally in Haliburton and Peterboro counties, on behalf of the Conservation Commission, with a view to discover the cause of their present condition, and what remedies can be applied to restore

them to usefulness. Fires were the principal cause, and in some cases the land has been farmed when it should not have been.

\* \* \*

The proposed railroad to connect Montreal with the National Transcontinental at the head of the Ottawa River, will open up several fine pulpwood areas. It will cross the Lievre, Gatineau and Coulange rivers at places where wood and power can be secured in large quantities.

\* \* \*

F. N. McCrea, president of the Brompton Pulp and Paper Co., and B. F. Howard, pulpwood dealer, Sherbrooke, Que., have been retained on the advisory board for the province of Quebec in the matter of the Canadian Bank of Commerce taking over the Eastern Townships Bank.

\* \* \*

As a significant commentary on the argument used by opponents of the legislation in New Brunswick prohibiting the export of wood from Crown lands, to the effect that it would decrease the price of wood on other lands and so injure the farmers, it may be stated that pulpwood cut from private lands along the St. John River is now selling for the highest prices ever known, or \$6.50 to \$7.00 per cord.

\* \* \*

The annual statement of the Spanish River Pulp & Paper Mills, Limited, shows gross revenue for the year 1911 of \$309,263. Of this amount bond interest took \$106,627 and dividends on preferred stock \$105,000. In addition, the sum of \$39,328 was applied to renewals and depreciations and \$2,000 written off deferred charges, leaving \$56,317 to be carried forward to surplus account. These results were obtained without any contribution from the large paper mills which are now nearing completion and which should add very materially to the earnings for the coming year, as it is expected that the entire new portion will be in operation by May 1st.



The Spokane, Wash., capitalists who contemplate building a pulp and paper mill at Nelson, B.C., have now acquired a site of 100 acres of land at the foot of Graham Falls, where they will develop 5,000 horsepower. The power development and the first units of the pulp and paper plants will involve an outlay of \$300,000. The soda process will be employed. Among those chiefly interested are Henry Hall, C. Pride and W. C. Bigelow, hydraulic engineer, Spokane.

\* \* \*

Judgment in the Supreme Court case of Benjamin F. Howard, pulpwood dealer, Sherbrooke, Que., against Quebec and St. Maurice Industrial Co., has been reserved. Both parties carry on large operations on the Gilbert and Chaudiere Rivers. The period for pulpwood and log driving is very short, and when there is sufficient water in the Gilbert River for driving, it is necessary for the several owners to accommodate each other. Each party alleges that the other obstructed his logs by booms placed at the mouth of the river and cross actions were brought to get a declaration as to their respective rights. A large portion of the pulpwood shipped to Berlin Mills, N.H., is handled by the Quebec & St. Maurice Industrial Co.

\* \* \*

A number of the largest pulp mill and power development companies dependent upon the waterpower and timber resources of the St. Maurice River Valley in Quebec province, have formed the St. Maurice Valley Forest Protective Association. It will patrol the whole district, placing men in all the larger streams to follow the prospectors, hunters, fishermen and others, and see that they extinguish all camp fires and observe government regulations. Look-out stations will be established on high hills, telephone lines constructed, etc. This is an attempt to put fire protection by several companies on a mutual and systematic basis. The Quebec Government will probably give some assistance. Three Rivers will be the head office of the Association.

Floods in Georgetown a few days ago did some damage at Wm. Barber & Bros.' paper mill there.

\* \* \*

The annual meeting of the Canada Paper Co. took place in Montreal last month, when the reports showed a very prosperous year for 1911. Although no dividends were declared, the progress made was so satisfactory that it is believed they will be resumed shortly. The following were elected directors: Joseph Kilgour, Toronto, president; Sir Montague Allan, Montreal, vice-president; and Hugh A. Allan, C. R. Hosmer, H. S. Holt, H. Markland Molson and Hon. Robert Mackay, all of Montreal.

\* \* \*

In the case of Davey v. Foley-Rieger Pulp Co., an appeal was made by plaintiff from part of the judgment of a Divisional Court of the 9th of June, 1911, on plaintiff's appeal from trial Judge. The plaintiff's action was for damages, and an injunction restraining defendants from discharging into the tail-race of plaintiff's mill a volume of water, much greater than was formerly discharged therein by defendant's predecessors in title, and breaking down the stone wall which had been erected and maintained by plaintiff there for over twenty-five years. The trial Judge dismissed the action with costs, the Divisional Court varying that judgment by holding that the title to the tail-race was vested in defendants; that the defendants were entitled to break the wall in question, but that plaintiff was entitled to an easement acquired by prescription in the tail-race, and that defendants were only entitled to discharge into the tail-race 100 horsepower of water, but that the defendants had the right to enlarge the tail-race to such an extent as would enable the increased discharge needed by them. The judgment appealed from is varied by declaring parties entitled in common to the small triangular piece of land for their respective raceways with all necessary directions and variations consequent on such declaration. No costs of appeal. Magee, J. A., dissents.



## TRADE AND MANUFACTURERS' NOTES

### GREEN BAY BARKER COMPANY.

The Green Bay Barker Company, Green Bay, Wis., has finished installing five Green Bay barkers for the Lake Superior Paper Co., Sault Ste. Marie, Ont., and additional installations for the Dells Pulp and Paper Company, Eau Claire, Wis.; Menasha Paper Company, Ladysmith, Wis.; Emmet Lumber Company, Cecil, Mich.; Hollingsworth & Whitney Company, Madison, Me.; Cheboygan Paper Company, Cheboygan, Mich.; Fletcher Paper Company, Alpena, Mich.; Brompton Pulp and Paper Company, East Angus and Bromptonville, Quebec; Rhinelander Paper Company, Rhinelander, Wis., and the Colonial Wood Products Company, Thorold, Ont. The Green Bay Barker Company has orders on hand for these barkers from Norway, Finland, Sweden, Germany and Austria, and has just completed shipments to Denmark, Switzerland and Belgium. Kymenne Aktiebolag, Kymennebruk, Finland, was the first European mill to install this machine and has since added eight more. Other Scandinavian mills followed, until there are now nearly a hundred of them in the various mills throughout the European continent, and the barkers have met with demonstrated success wherever installed.

\* \* \*

### HOW TO GET DURABLE PAPER FOR PERMANENT RECORDS.

In specifying the qualities of a paper for permanent records, says H. P. Caruth, of Arthur D. Little, Inc., a large percentage of ash is to be avoided, and a clause should be inserted in the specifications limiting the amount allowed. In cases where no filler is to be allowed it should be remembered that "broke" (paper waste) is not disadvantageous under ordinary conditions, and the ash limit should therefore be set sufficiently

high, say 2.5 per cent., as to allow of its use in reasonable quantities. A properly drawn specification containing limits on strength and rosin will effectively guard against undue percentages of "broke." Such a specification besides insuring satisfactory results to the purchaser will leave the paper manufacturer a reasonable elasticity under ordinary manufacturing conditions.

\* \* \*

The name of the Advance Machine Works, Limited, Walkerville, Ontario, who are manufacturers of Northern Cranes and Hoists in Canada, has been changed to Northern Crane Works, Limited. They will continue the manufacture of Northern Cranes, Hoists, etc., the same as heretofore. They have recently completed a new plant at the corner of Argyle Road and Essex Terminal, in Walkerville, and report a large number of contracts in progress and covering electric traveling and hand power traveling cranes and electric hoist work of various large Canadian companies. They report an increasing demand for Northern patented type "E" electric traveling cranes.

\* \* \*

### DIRECTORY OF PAPER MAKERS.

We have received the 1912 edition of the Directory of Paper Makers of the United Kingdom, which has been thoroughly revised up to date. Special attention is drawn to the list of trade designations, divided into two sections, viz.: (1) Actual watermarks, and (2) Trade names (not being actual watermarks), making the book particularly valuable to printers, stationers, and paper buyers generally. Full lists are given of the British paper manufacturers under various headings. The price of the book, which is published by Marchant, Singer & Co., 47 St. Mary Ave., London, is 1s. 4d. net, post free in United Kingdom, or 1/8 abroad.

### COOLING ROLLS ON PAPER MACHINES.

A writer in *Wochenblatt* discussing the question whether to damp the paper on the machine before reeling or afterwards on a special damping machine, strongly contends that the damping on the paper machine can be done quite satisfactorily provided proper arrangements are to hand. On most German paper machines the paper is slit on leaving the machine and is reeled up on spar drums. If the distance between the slitting knives and the reeling drums be too great the tension cannot be kept sufficiently taut and in such cases damping on the machine is liable to cause the reels to run askew. This, however, is no argument against damping on the machine, since it is easily remedied by proper regulation of the distances. No doubt a separate damping machine possesses certain advantages, especially for fine papers, but uniform working, followed by uniform glazing, can only be ensured if the reels of paper have been thoroughly cooled before damping. If the paper is still warm the moisture is absorbed irregularly and trouble is likely to arise just as much as if the damping were done on the paper machine. However carefully the paper machine be attended, it is never possible to dry a reel of paper perfectly evenly; there are innumerable stages between the conditions of "just dry," "hot-dry" and "over-baked," which cause irregularities in damping unless the paper be first cooled. For instance, when a break occurs, cylinders become over-heated unless the steam is turned off at the same moment.

The trouble and expense of a special damping machine may quite well be avoided, but only if the paper machine be provided with a large and efficient cooling roll, so that the paper may be cooled before damping. Improvements in the design of cooling rolls have not kept pace with improvements in paper machines of recent years and their increased speeds. Many paper machines are run without any cooling roll at all,

whilst in others the cooling surface is altogether inadequate, being provided by a roll 10 to 16 inches in diameter, with which the paper comes in contact over only one-half or two-thirds of its circumference. Such rolls cannot possibly cool the paper sufficiently to ensure the moisture of the damper being evenly distributed, and they are a fertile source of trouble owing to the paper sticking to the surface and winding round the roll. The writer gives his views as to what a properly constructed cooling roll should be in order that its presence should prove a real benefit to the manufacturer. It should have a diameter of at least 30 to 46 inches and should be constructed of cast-iron with a shell of copper. It is absolutely essential on fast machines that a doctor should be fitted to prevent the paper winding round the cylinder, and a plain copper shell without a cast-iron support will not stand the pressure of a doctor. A sufficient flow of cold water inside must be provided, and the paper should be pressed in contact with the cylinder by means of a woolen felt. Some mills have so far recognized the importance of cooling the paper that they have fitted up the last drying cylinder as a cooling roll, supplying it with cold water instead of with steam. The advantage is felt not merely with damped and super-calendered papers, but also in the case of rough or machine-finished papers, since the cooling roll removes the electricity from the paper; it also enables the machineman to judge his weights more accurately, since irregular drying means irregular weights.



—The International Paper Company has given official notice of an advance in wages of 1c. per hour to all its employees working on an hourly basis, to take effect May 1st. The increase, which is a voluntary action on the part of the company, will mean an additional outgo of \$150,000 per year, as it affects the employees of all its mills in the United States, thirty-two in number.

## ONTARIO PULP AND PAPER COMPANY.

The Ontario Pulp and Paper Company have taken possession of the large paper and sulphite mills recently acquired at Sturgeon Falls, and already over 200 men are at work on the different plants, getting things in readiness. A large proportion of the plant is in readiness for operations, while the newsprint paper mill will be under way by the beginning of May.

The recent equipment of the different mills give them a producing capacity of 18,000 tons of sulphite per year, 15,000 tons of newsprint paper and 18,000 tons of ground wood pulp. The cut made on the company's limits during the present winter will enable the different plants to keep in full operation from the time they start. T. H. Watson, managing director, and A. E. Millington, general manager, have been busy concluding arrangements for the opening of the mills.

It had been arranged by the Dominion Bond Co. to issue \$1,500,000 of 6 per cent. bonds and \$1,500,000 of common stock. At the time it was the intention to place a considerable portion of the securities on the market, but the statement is now made that of the \$1,500,000 of bonds, already subscriptions have been received of \$1,400,000, so that only \$100,000 of bonds were placed on the market, which were offered at par, carrying a bonus of 25 per cent. common stock. The company's officers are as follows: President, W. J. Sheppard; vice-president and managing director, T. H. Watson; directors, J. B. Tudhope, G. P. Grant, R. L. Innes, A. H. B. Mackenzie, C. Kloepfer and R. A. Lyon. Messrs. J. R. Barber, W. H. Tottie and A. McPherson retire.

### SAVING OF MILL REFUSE.

Wallace P. Cohoe, Ph.D., vice-chairman of the Canadian Section of the Society of Chemical Industry, in an address before that body in Toronto last

month, outlined a scheme for the conversion of sawdust into glucose, which can either be refined and sold as commercial glucose, or mixed with yeast and made into alcohol.

Experiments are being made in a laboratory, and it is claimed that the industry has a great future in view of the fact that gasoline is getting high in price, and that it will be possible to use the product in question in an ordinary automobile. In the United States and Germany it is used largely in the manufacture of explosives and varnishes.

On a laboratory scale, Mr. Cohoe said they had been able to produce alcohol that ran 25 gallons of 94 per cent. spirits per ton, and on an industrial scale 20 gallons of 94 per cent. spirits per ton.

It was claimed that other by-products would be even more profitable to the manufacturer than the glucose or alcohol. The alcohol produced by the combination was said to be high grade, and entirely free from fusel oil.



## CANADIAN PULP AND PAPER MARKETS.

Toronto, April 6, 1912.

There is a strong demand for newsprint, both for domestic and United States requirements. In spite of the increased production in the latter country, all offerings have been readily absorbed, the demand seeming to increase with the approach of the pre-election campaign. Prices are very firm.

Not much complaint is made as to the amount of business coming in to the book and writing mills, but some expect greater briskness in the demand in the near future. English firms are pushing hard for business.

There is a better feeling in the kraft and fibre branches. Manilas are selling materially better, with an upward tendency in prices. Building papers are in strong demand.

There is no particular change to re-

cord in the situation of miscellaneous paper stock.

Ground wood pulp is easier in price and the demand for it from the States is not very brisk, owing to the good water conditions there. It is not likely that prices will regain their strength until dry conditions begin to prevail again. Sulphite, on the other hand, is in a strong position, partly owing to the scarcity in Europe, where the demand seems to have overtaken the consumption.

We quote:—

News print, rolled .....	\$1.90 to \$2.00
News print, sheets .....	2.15 to 2.25
Book papers—Carload lots	
No. 3 .....	4¼ to 4½c.
Book papers—Broken lots	
No. 3 .....	4½ to 4¾c.
Carload lots No. 2 .....	4¾c.
Broken lots No. 2 .....	5½ to 5¾c.
Carload lots No. 1 .....	5½ to 6¼c.
Broken lots No. 1 .....	6 to 6¾c.

#### Wrappings—

Manila B. ....	2½ to 3¼c.
Fibre ..	3½ to 3¾c.
No. 2 Manila ..	3¼ to 3¾c.
No. 1 Manila ..	3½ to 4 c.
Kraft .....	4¼ to 4½c.

#### Pulp—

Ground wood (at mil) .....	\$14 to \$16
Sulphite (bleached) .....	\$53 to \$55
“ (unbleached) .....	\$43 to \$44

#### Waste Papers—

	Per 100 lb.
	F.o.b. Toronto.
No 1 Hard White	
Shavings .....	\$1.65 to \$1.75
No. 2 Hard White	
Shavings .....	.....
White Envelope Cuttings .....	\$1.65 to \$1.75
No. 1 Soft White	
Shavings .....	\$1.45 to \$1.50
No. 2 Soft White	
Shavings .....	\$1.25
No. 3 Soft White	
Shavings .....	\$1.10
White Blanks .....	\$1.10
Mixed Shavings .....	35 to 37½c.

Heavy Ledger .....	\$1.27½ to \$1.40
Ordinary Ledger .....	\$1.00 to \$1.10
No 1 Flat Books .....	80 to 90c.
No. 1 Book Stock .....	75 to 80c.
No. 2 Book Stock .....	39½ to 40c.
No. 1 Manila Envelope Cuttings...	\$1.20
No. 1 Print Manilas .....	65c.
Railway Manilas .....	55c.
Folded News Overissues .....	45c.
Folded News .....	45c.
Crushed News .....	.....
No. 1 Mixed Papers .....	25 to 35c.

#### Rags (New and Old)—

	Per 100 lb.
1st Old White Cottons .....	\$2.00
2nd Old White Cottons .....	.....
Thirds and Blues .....	\$1.25 to \$1.45
Roofing Stock—	
Flock Satinets .....	75 to 80c.
Ordinary .....	55 to 60c.
Tailor Sweepings .....	55 to 57½c.
No. 1 White Shirt Cuttings .....	\$4.75 to \$5.00
No. 2 White Sheet Cuttings .....	.....
Fancy Sheet Cuttings .....	\$3.65 to \$3.75
New Blue Prints .....	.....
New Blue Overalls .....	\$3.42½ to \$3.65
New Black Overalls .....	\$1.60 to \$1.70
New Black Linings .....	\$1.60 to \$1.75
New Unbleached Cottons .....	.....
Bleached and Unbleached Shoe Clips...	.....
New Light Flannelettes ..	\$3.75 to \$4.40
New Light Shirt Cuttings ..	\$3.90 to \$4.35
Light and Dark Cords .....	.....



#### NORWEGIAN MARKETS.

C. E. Sontum, Canadian trade commissioner in Norway, reports that there is hardly any unsold pulp in Norway. The latest sales, small prompt parcels, have been at \$13.33 for "good ordinary quality" f.o.b. steamer, Norway. Makers, he asserts, will not be able to supply all they have sold for winter delivery. For future deliveries it is impossible to obtain reliable quotations. Lack of water is still hampering production, so that prices are looked upon as likely to remain firm. Over a dozen paper machines were erected in Norway during 1911.



---

# EMERSON MANUFACTURING CO.

## LAWRENCE, MASS.

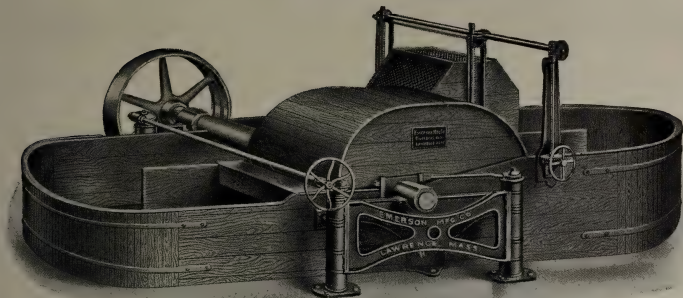

Beating and Washing Engines  
Paper Mill Machinery

---

**THE UNITED WIRE WORKS LTD,**  
EDINBURGH, GLASGOW & NEWCASTLE-ON-TYNE  
**FOURDRINIER WIRES, CYLINDER WIRES,**  
AND WIRE CLOTH OF ALL KINDS.

AGENTS, ARTHUR P. TIPPET & CO 8 PLACE ROYALE MONTREAL.  
WIRES HELD IN STOCK AT MONTREAL FOR PROMPT DELIVERY.

# ARTHUR P. TIPPET & CO.

Agents and Importers

**PAPER MILL SUPPLIES**

**SULPHUR FELTS**

Sal Ammoniac,

Borax,

Santitie, etc.

**MONTREAL**

-

**TORONTO**



ALL KINDS OF  
Machines for Paper, Pasteboard,  
Cardboard, Cellulose  
and Pulp Mills

Calenders      Patent Beaters  
Winders      Calender Roll Lathes  
Filters (Füllner's Construction)  
Cutters      Cone Refiners  
High Power Grinders      Paper Machines  
Kollergänge (Edge Runners)

FIRST-CLASS REFERENCES

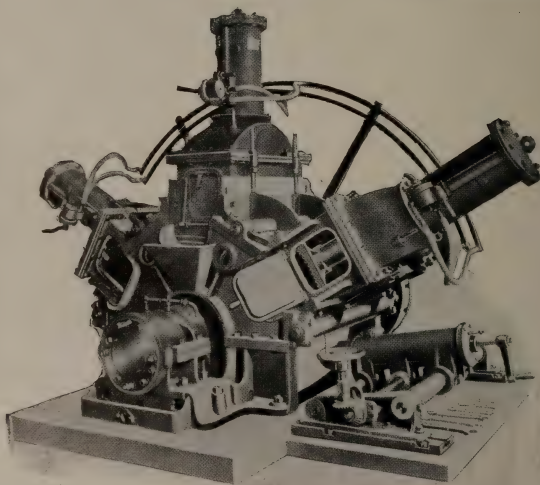

MOST MODERN CONSTRUCTION

Founded 1854

**H. FÜLLNER**

WARMBRUNN  
SILESIA  
GERMANY

Prizes won at all exhibitions where machines have been shown.  
Turin 1911 "Grand Prize," highest award.

# CLASSIFIED ADVERTISERS' INDEX.

If you fail to find what you want in these columns, write us and the desired information will be gladly supplied.

- Architects and Engineers**  
 Arbursen Hydraulic Con. Co.  
 Fred C. Anderson  
 Clark & Lyford  
 F. W. Dean  
 J. A. DeCew  
 Eaton & Brownell  
 Fibre Development Co.  
 Geo. F. Hardy  
 Herbert S. Kimball  
 International Process Co.  
 Arthur D. Little, Inc.  
 R. S. Lea & H. S. Ferguson  
 Lyford, Clark & Lyford  
 H. B. Prather  
 T. Pringle & Son  
 Stebbins Eng. & Mfg. Co.  
 R. O. Sweezy  
 Jos. H. Wallace & Co.
- Barkers.**  
 Green Bay Barker Co.  
 Jenckes Mach. Co.  
 Waterous Engine Works.
- Barker and Chipper Knives.**  
 Crookes, Roberts & Co.  
 Peter Hay Knife Co.  
 A. P. Tippet & Co.
- Beaters.**  
 Dayton Globe Iron Works  
 Emerson Mfg. Co.  
 Holyoke Mach. Co.  
 E. D. Jones & Sons Co.  
 Valley Iron Works  
 Waterous Engine Works
- Beater Rolls.**  
 J. A. DeCew  
 J. Marx & Co.
- Belting.**  
 Dom. Belting Co.  
 General Supply Co.  
 F. Reddaway & Co.  
 Sadler & Haworth
- Bleaching Powders.**  
 Hooker Electro-Chemical Co.  
 Winn & Holland
- Bollers**  
 John McDougall Caledonian Iron Works
- Bond Papers.**  
 Northern Mills Co.
- Book Papers.**  
 Canada Paper Co.  
 Northern Mills Co.
- Brass Wire Cloth, Fourdrinier W. res.**  
 Geo. Christie, Ltd.  
 J. M. Douglas & Co.  
 Herman Finckh  
 C. H. Johnson & Sons, Ltd.  
 A. P. Tippet & Co.  
 United Wire Works.  
 P. P. Westbye
- Calender Rolls.**  
 Camel Hair Belting  
 F. Reddaway & Co.  
 Farrel Foundry & Mach. Co.
- Chemicals, Colors, etc.**  
 Brunner, Mond & Co.  
 Gewerkschaft Sachtleben  
 A. Klipstein & Co.  
 Paper Makers' Chemical Co.  
 United Alkali Co.  
 Wilson-Paterson Co.
- China Clay.**  
 China Clay Co.  
 A. Klipstein & Co.  
 C. A. Meincke & Co.  
 Paper Makers' Chem. Co.  
 Wilson-Paterson Co.
- Chippers**  
 Carthage Machine Co.
- Coated Paper.**  
 Canada Coating Mills  
 Canada Paper Co.
- Conveying Machinery.**  
 Jeffrey Mfg. Co.
- Digester Lining.**  
 Panzl Digester Lining Co.  
 Preston's Digester Lining Co.  
 Stebbins Eng. & Mfg. Co.
- Digesters**  
 Swenson Evaporator Company
- Drainer Bottoms.**  
 Samuel Snell Co.
- Evaporators**  
 Ernest Scott & Co.  
 Swenson Evaporator Co.  
 Zarembo Company
- Exporters**  
 Parsons Trading Company
- Felts.**  
 F. Bredt & Co.  
 Dallyn, Jardine & Co.  
 Hamelin & Ayres Co.  
 C. H. Johnson & Sons, Ltd.  
 Penman's Ltd.  
 Joseph Porritt & Sons.  
 J. H. Spencer & Sons  
 A. P. Tippet & Co.
- Grinders.**  
 Dayton Globe Iron Works  
 Glens Falls Mach. Co.  
 Holyoke Machine Co.  
 Jenckes Machine Co.  
 Waterous Engine Works.
- Kraft Paper.**  
 N. B. Pulp & Paper Co.
- News-Paper, Wrappings, etc.**  
 New Brunswick P. & P. Co.  
 Riordon Paper Co.
- Paper and Pulp Dealers**  
 Atterbury Bros.  
 Albert E. Mallandian  
 Castle, Gottheil & Overton.  
 Parsons Trading Co.  
 Pulp and Paper Trading Co.  
 A. Wertheim & Co.  
 Riordon Paper Co.
- Paper Stock, Rags, etc.**  
 Atterbury Bros., Inc.  
 J. Christie Co.  
 R. Hough  
 The Howell Co.  
 E. Pullan  
 J. R. Walker & Co.
- Paper and Pulp Mill Machinery.**  
 Appleton Machine Co.  
 W. G. Ashdown  
 Baker & Shevlin Co.  
 Beloit Iron Works  
 Bentley & Jackson  
 James Bertram & Son, Ltd.  
 Bertram's, Limited  
 The Black-Clawson Co.  
 Canadian Boving Co.  
 Carthage Machine Co.  
 Dayton Globe Iron Works Co.  
 Dillon Machine Co.  
 Emerson Mfg. Co.  
 Farrel Foundry & Machinery Co.  
 M. Garland Co.  
 Glens Falls Machine Works.  
 Green Bay Barker Co.  
 Harmon Machine Co.
- Holyoke Machine Co.**  
 Jenckes Machine Co.  
 E. D. Jones & Sons Co.  
 C. H. Johnson & Sons, Ltd.  
 Jas. Milne & Sons.  
 Moore & White Co.  
 Marx, J. & Co.  
 B. F. Perkins & Son.  
 Rice, Barton & Fales  
 Rytther & Pringle.  
 Sandy Hill Iron & Brass Works.  
 Ernest Scott & Co.  
 Sherbrooke Ma-hinery Co., Ltd.  
 S. Morgan Smith.  
 Stebbins Engineering & Mfg. Co.  
 Swenson Evaporator Co.  
 Ticonderoga Machine Works.  
 Valley Iron Works.  
 J. M. Voith.  
 Charles Walmsley & Co.  
 Chr. Wandel.  
 Wandel Screen Mfg. Co.  
 Waterous Engine Works Co. Ltd.  
 P. P. Westbye.  
 Zarembo Co.
- Paper Testers.**  
 Dobler & Mudge.
- Pipes (Wooden)**  
 Eastern Pipe & Construction Co.
- Pumps.**  
 Lawrence Machine Co.  
 Lawrence Pump & Engine Co.  
 John McDougall Caledonian Iron Works.  
 Smart-Turner Mach. Co.
- Rosin Size.**  
 Paper Makers Chemical Co.  
 Vera Chemical Co.  
 United Alkali Co.  
 Wilson-Paterson Co.
- Screen Plates.**  
 Union Screen Plate Co. of Can.
- Screens.**  
 W. G. Ashdown  
 Harmon Machine Co.  
 Sherbrooke Machinery Co.  
 J. M. Voith.  
 Chr. Wandel.  
 Wandel Screen Mfg. Co.  
 Waterous Engine Works.  
 P. P. Westbye.
- Sulphur.**  
 Union Sulphur Co.
- Tanks.**  
 John McDougall Caledonian Iron Works  
 G. Woolford Wood Tank Mfg. Co
- Transmission Machinery.**  
 Dodge Manufacturing Co.
- Travelling Cranes.**  
 Advance Mach. Co.  
 Hugh R. Blethen  
 Northern Eng. Co.  
 Smart-Turner Mach. Co.
- Turbines.**  
 Dayton Globe Iron Works.  
 S. Morgan Smith Co.
- Water Wheels.**  
 John McDougall Caledonian Iron Works  
 Dayton Globe Iron Works.  
 Holyoke Machine Co.
- Wood Pulp Agents.**  
 Castle, Gottheil & Overton.  
 Churchill & Sim  
 Parsons Trading Co.  
 Scandinavian Amer. Trading Co  
 A. Wertheim & Co.

If you have not ordered a copy of the new "**Canadian Pulp and Paper Directory**," do it now. Your promptness will save you \$1. The price to non-subscribers, after publication, will be \$3. To subscribers before publication \$2.

Address :

**BIGGAR-WILSON, LIMITED**  
 CONFEDERATION LIFE BLDG,  
 TORONTO

The ::

# West End Engine Works Co.

PAPERMAKERS'  
 ENGINEERS

- - - EDINBURGH

Specialists in all kinds of  
Papermaking Machinery

Duplex, Angle and Square Cutters, Vickery's Laying Machines,  
 Improved Umpherston Beaters, &c., &c.

PRICES ON APPLICATION

Telegrams : West End, Edinburgh

# PAPER AND CLOTH SPECIALTIES

For Rent and Club Cards, Pattern Cards, Map Printing,  
Label Printing, Envelopes, Etc., Etc.

*Cloth Lined Papers. Cloth Centred Papers and Boards. Cloth Lined, Chromo and Enamel. Cloth Lined Boards and Cards, (surfaced and enamelled). Cloth centred Boards, (surfaced and enamelled). Manilla Surfaced Boards and Cards.*

ALSO

*Ename led Blotting.*

*Paste Boards.*

*Art Papers.*

*Chromo and Surface Papers.*

Customers' requirements in specialities are carefully considered and experiments conducted if necessary.

**ALBERT E. MALLANDAIN,**  
MANUFACTURER

OFFICES : 51 Cheapside  
London, E.C.

MILLS : Park Royal  
Willesden, London, N.W.

# HERMANN FINCKH

REUTLINGEN

*Established 1879*

GERMANY

---

# FOURDRINIER WIRES

---

**SULPHITE - MACHINE WIRES**  
**CYLINDER WIRES**

---

---

**P. P. WESTBYE, - Peterborough, Ontario**

*Sole Agent for Canada*

# Worthington Pumps

SPECIALY DESIGNED TO MEET  
... THE CONDITIONS OF ...

## Pulp & Paper Mills

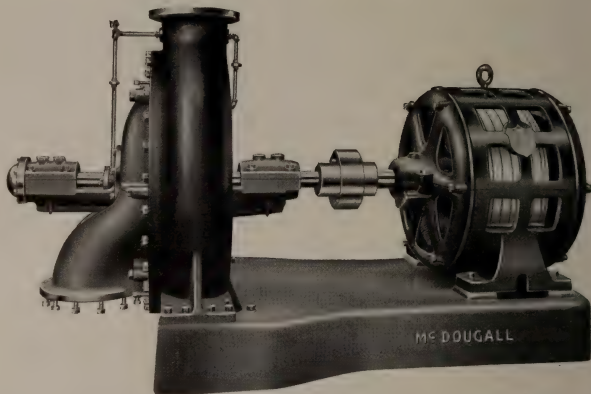

**Turbine Pump Capacity 4,000 U.S. gals. per min.  
for Water Supply.**

---

SEE BULLETIN 108

---

**THE JOHN McDOUGALL  
Caledonian Iron Works Co.**

LIMITED

Works

-

-

-

Montreal



## Perkins Bleach Ejectors

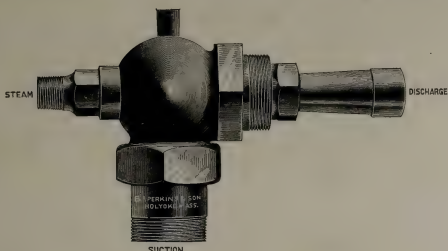

will pump your Bleach at practically no cost, first or last. Made in different sizes to meet all requirements. Write for special circular with list of references.

**B. F. Perkins & Son, Inc., - Holyoke, Mass.**

**FROZEN PULP AND DRY PULP  
IN A**

## Ryther Shredder

Is shredded at the rate of 5 tons per hour. 17 to 25 H. P. required. The above figures are *dry weight* and absolutely guaranteed.

RELIEVE YOUR BEATERS and INCREASE QUALITY and PRODUCTION. Write for full Particulars.

---



---

**Ryther & Pringle Company**  
Carthage, N.Y.

VALLEY IRON



WORKS COMPANY

# BEATING AND WASHING ENGINES

IRON OR WOOD TUBS

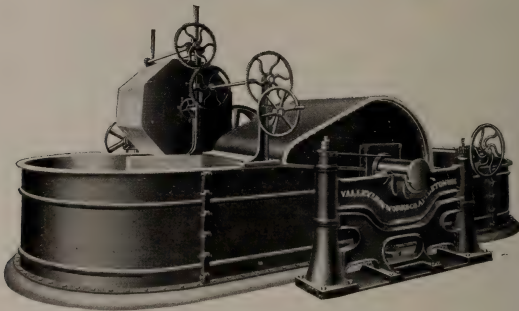

*Perfection in Every Detail.*

Beating, Washing and Bleaching Engines. Barkers—Barker Attachments—Chippers—Rechippers—Chip Screens (Revolving)—Knot Screen (Revolving)—Diaphragm Screens—Felt Washers—Deckers (Single and Double)—Stuff Chests (Vertical and Horizontal)—Tanks (Blow Off, Acid and Water)—Pulpwood Saws (Friction and Steam Feed)—Pulpwood Splitters (Vertical and Horizontal)—Shredders and Special Washers for old Paper Stock—Wet Machines and Patent Roll Skinners—Bronze, Semi-Steel, Lead and Iron Castings.

**Manufacturers of Paper and Pulp Making Machinery in**

*All Standard Forms — Many Special Designs*

**ENGINEERS, FOUNDERS AND MACHINISTS**

*Correspondence Invited*

**VALLEY IRON WORKS COMPANY**

**APPLETON, WIS., U.S.A**

---

---

FARREL FOUNDRY AND MACHINE  
COMPANY

ANSONIA, CONN., - - - U. S. A.

Largest Manufacturers in the world of

**CHILLED ROLLS**

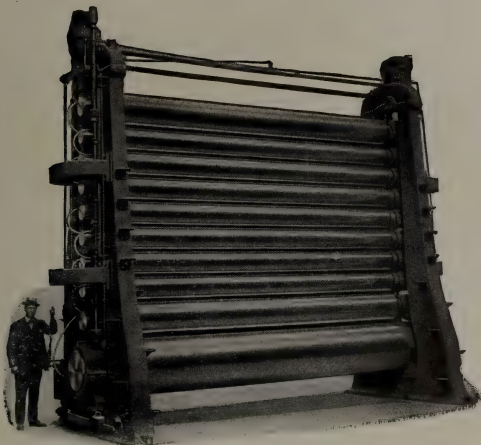

**CALENDERS**

*WITH PATENT HYDRAULIC LIFT*

**ROLL GRINDING MACHINES**

---

---

Would YOU like to enlarge your Business and find new Customers in all parts of the world? If so, ADVERTISE in

# “THE PAPER-MAKER AND BRITISH PAPER TRADE JOURNAL.”

THE LEADING AND MOST POPULAR TRADE ORGAN.

**THE ADVERTISER IS GOOD FOR THE READER**

We recently received the following letter:—

“We have hesitated over the matter, as we are at present so busy as to regard further advertising as almost superfluous.

“On the whole, however, we find it pays us better to have to refuse orders than to hunt after them, and will ask you therefore to insert our advertisement on same terms as last.

“We enclose herewith amended matter for advertisement, and shall be glad to have proof of same at your early convenience.”

We are constantly in the receipt of gratifying letters relative to the usefulness of our Journal, and we have pleasure in printing the following:

“Gentlemen,

We beg to advise that we have not as yet received the June number of ‘THE PAPER-MAKER AND BRITISH PAPER TRADE JOURNAL.’

We like the publication so well that we should be very sorry indeed to miss a copy of it.

Thanking you in advance for your kind attention,

We are, dear Sirs, yours very truly,  
F. R. KEYES & SON.  
20 Broad Street, New York.”

## S. C. PHILLIPS & Co.'s STANDARD PUBLICATIONS

### The Paper-Maker

AND BRITISH PAPER TRADE JOURNAL.

Published on the 1st of each month. Price 1s., by post 1s. 6d. Annual Subscription 12s. 6d. post free.

**The Stationery World,  
Printing and Allied Trades,**  
AND FANCY GOODS REVIEW.

Published on the 25th of each month. Price 6d. by post 7½d. Annual Subscription 5s. post free.

Chief Offices:

47 CANNON STREET, LONDON, E.C. (ENGLAND).

### The Paper Box and Bag Maker.

Published on the 19th of each month. Price 6d., by post 7½d. Annual Subscription 6s. 6d. post free.

**Phillips' Paper Trade Directory  
of the World**

15s. 6d., post free to all countries.

NEW EDITION FOR 1911 NOW READY.

Specimen Copies and Advertisement Rates  
FREE OF APPLICATION.

# "LAWRENCE" Centrifugal Pumps

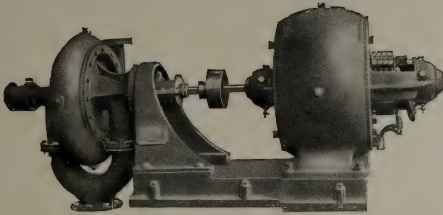

High-grade Pumping Machinery  
for all Purposes

PAPER MILL WORK  
A SPECIALTY

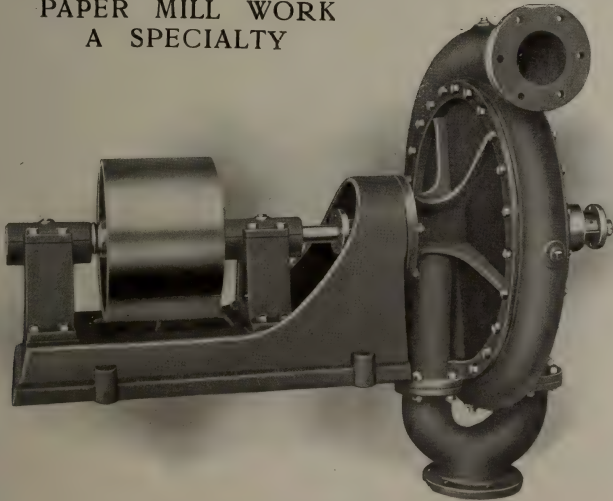

Let us figure on your requirements

## Lawrence Machine Company

LAWRENCE

MASS.



**UNDER MANAGER.**—Young man, 14 years' practical experience in English mill making long elephants, news, all-wood printings, cream laids, etc. Experienced mill chemist—testing of papers, fibres, etc. Highest references. Address H. C., c/o Pulp and Paper Magazine.

**WANTED.**—Superintendent for a new 150-ton ground wood mill. One with technical education preferred. Please state education and experience in full; also give age, if married or single, and salary asked for. Address Box 27, care Pulp and Paper Magazine, Toronto.

As we are using all our Water Power at our Pulp Mill for electricity, we are disposing of the Pulp Mill Machinery—including Millard Patent Grinders which were in use only a few months and are absolutely as good as new, also Wet Machines, Barkers, Screens, Pumps, Piping, Shafting, Stones, etc., etc., all in good condition. Full information will be given upon application.

Apply Box "A,"

Pulp and Paper Magazine,

Toronto.

**FOR SALE.**

A 92-inch Fourdrinier machine, complete, now running in Canadian mill, to make room for a larger machine.

For particulars, etc., address Box 25, Pulp and Paper Magazine.

**PAPER MILL ENGINEER.**—Technical graduate, ten years' experience, now consulting engineer for one of the largest paper mills in United States, wants change. Open for engagement in near future. Will give part or whole time. Apply Box 26, Pulp and Paper Magazine, Toronto.

**A GENTLEMAN** from Scotland, resident in Toronto, having had practical experience in all departments of paper making, would like to hear from firms to whom his services might be of use. He has had wide and varied experience "on the road" in the printing and stationery trades, also the manufacture of paper bags. Box (S.W.) Pulp & Paper Magazine.

**WANTED IMMEDIATELY**—Master mechanic, machinists, millwrights and pipefitters for Canadian soda, pulp and paper mill now under construction. Only experienced men need apply. State wage and give references. Apply Box Box D, Pulp and Paper Magazine.

**GEWERKSCHAFT SACHTLEBEN**

Homburg-Niederrhein

GERMAN Y

Largest Makers  
of all Qualities

**Blanc Fixe**

Bright

Matt or Dull

Photographic

Three  
Varieties

**SCOTT'S IMPROVED RECOVERY SYSTEMS**  
**FOR**  
**SODA, SULPHATE AND SULPHITE**  
**SPENT LIQUORS GIVE THE**  
**MAXIMUM ECONOMY AND EFFICIENCY**

*The* **PRINCIPLE**  
*The* **DESIGN**  
*The* **CONSTRUCTION**  
*The* **OPERATION**  
*The* **RESULT** } **IS RIGHT**

Complete Installations made by "THE FIRM WITH THE EXPERIENCE"

**ERNEST SCOTT & CO. MANUFACTURING ENGINEERS**  
**FALL RIVER, MASS. and MONTREAL, P.Q.**

**SODA OR SULPHATE**

**RECOVERY SYSTEM**  
**MAXIMUM EFFICIENCY                      MINIMUM LOSSES**

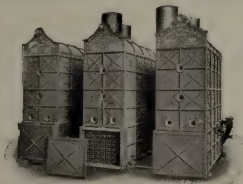

**WELDED DIGESTERS      MULTIPLE EFFECT EVAPORATORS**  
**AND OTHER PULP MILL EQUIPMENT**

**SWENSON EVAPORATOR CO.**

945 Monadnock Bldg. . . . . CHICAGO

Established  
1869

**CHR. WANDEL,**

Established  
1869

REUTLINGEN . . . GERMANY

Paper Machine Wire and Engineering Works

SOLE MANUFACTURER OF

The Original "WANDEL" Rotary Screen

Over  
3,000  
Apparatus  
Sold

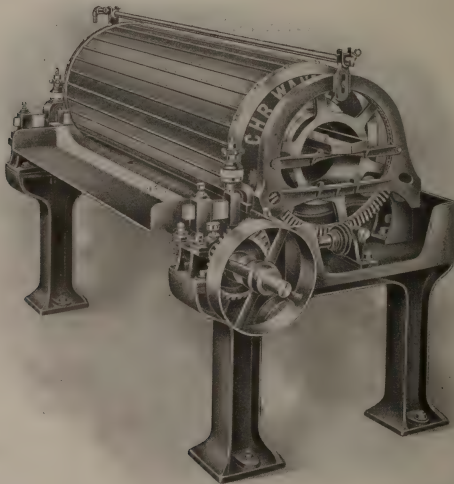

No authorized  
builder in  
Canada  
or the States

**ADVANTAGES:**

Regular output of Pulp  
Large working ability

Automatic removal of Knots  
Avoidance of Stoppage

Less Power . . . Great Strength and Durability  
Suitable for all classes of Paper

**Agent for Canada Wanted**

HIGH GRADE  
"VICTORIA" TURBO PUMPS

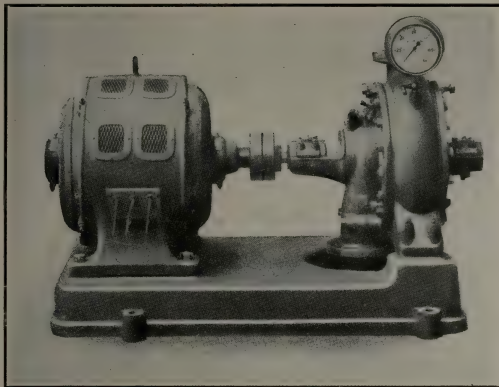

---

---

Suitable for all conditions. Water, pulp, caustic or acid. Highest efficiency. Flat characteristic curve. Unrivalled workmanship.

---

---

**THE CANADIAN BÖVING COMPANY, LTD.**  
164 BAY STREET : : : : TORONTO

**A GOOD JORDAN ENGINE**

BUILT IN 3 SIZES.

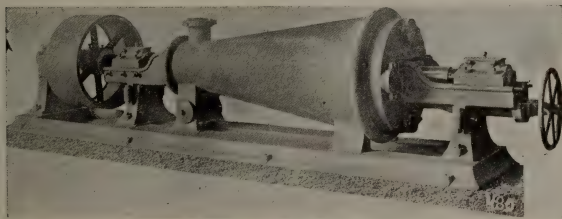

**THE BLACK-CLAWSON CO.**

HAMILTON, OHIO, U.S.A.

Builders of **PAPER MAKING MACHINES** and machinery for Paper and Pulp Mills. Our machines are completely erected in shop on cast iron levelling plates and carefully inspected before shipment.

*Write for Cata'ogue.*

**BRITISH MARKETS.**

—  
London, March 22nd, 1912.

The market for mechanical pulps is inactive with little or no business passing, though the circumstances do not seem to warrant this weakness, says "World's Paper Trade Review." Chemical pulp keeps firm in spite of the business depression due to the coal strike.

A fair inquiry is still experienced for chemicals, but actual business is on restricted lines. Reduced output and curtailed deliveries are reported as a consequence of the prolonged strike in the coal trade. Bleaching powder is said to be now practically unobtainable, many manufacturers having ceased production and cleared out stocks. Makers of ammonia alkali are arranging contracts for 1913 on terms tending to favor buyers. A reduction of 17s. 6d. per ton in the price of soda ash is authoritatively announced to take place as from July 1st next, subject to certain conditions. Ammonia alkali, 58 per cent., is quoted £4 5s. to £4 10s. f.o.b., Liverpool; bleaching powder, £4 15s. f.o.r.; caustic soda (high-strength), £10 2s. 6d.; soda crystals, £2 12s. 6d.; salt cake, £2 2s. 6d.

The market for rags is good.

**KRAFT PAPER FOR TEXTILE PURPOSES.**

—  
A special type of kraft paper is being manufactured in a Norwegian paper mill for spinning into yarn for textile purposes. Spruce wood, 10 to 11 inches in

diameter, felled in the winter, is employed, the wood chosen being a slow growth in hilly country. Vomiting boilers of 28 to 30 cubic metres capacity are used. The chips are cut into lengths about four-fifths of an inch and digested for four hours with a maximum pressure of 100 pounds per square inch, the heating being done exclusively by indirect steam, and the maximum pressure of 100 pounds only being reached one hour before discharging. The digestion liquor contains 6 per cent. of caustic soda and 3 per cent. of sodium sulphide.

By this treatment the wood is only cooked to the extent of about three-quarters, and whilst still warm it is thoroughly rubbed down in the Kollergang and then beaten in hollanders with blunt tackle for six or eight hours, first being gently brushed out, then treated more heavily, and afterwards beaten for half an hour with the roll full down. Finally the roll is raised again by slow degrees to refine the stuff. The speed on the paper machine does not exceed 165 feet per minute. The strainers have slits of 32/1,000 inch width. The paper is extremely tough, having a breaking length of 8,400 metres average, and breaking stretch of 5 per cent.; the resistance to folding and creasing on the Schopper machine shows an average of 3,400. The boiling made with direct steam does not give anything like so tough a fibre. This paper has given the greatest satisfaction to the spinners who are producing an excellent yarn by twisting it into threads.

# TOWNSEND

## ELECTROLYTIC CELL

---

2,500-5000 AMPERE UNITS. ALKALI AND CHLORINE.  
CAUSTIC SODA. BLEACHING POWDER. CHLORINE  
FOR ORES. LICENSES GRANTED. CANADIAN PATENTS  
91939 - 105088 - 105089.

---

**HOOKER ELECTROCHEMICAL COMPANY**  
40 WALL STREET, NEW YORK



Telephone: 2726 BROAD.

Cable Address: "LAGERLÖF NEWYORK."

# Scandinavian-American Trading Company,

PRODUCE EXCHANGE BUILDING, NEW YORK,

IMPORTERS AND EXPORTERS OF

FOREIGN AND DOMESTIC

# WOOD PULP

OF ALL KINDS

AND

# PAPER MILL SUPPLIES.

HANS LAGERLÖF, PRES.

# CROOKES, ROBERTS & CO.

SHEFFIELD ENGLAND

Makers of

Crucible Cast Steel  
Bed Plates  
Jordan Fillings  
Beater Bars



Makers of

Bessemer Cast Steel  
Crookes' Composition  
Fillings

And every description of Cutter Knives, Tools and Steel used and required in Paper Mills.

**ARGUS** High-Speed **STEEL** for fine machine tools is unsurpassed.

Once Used - Always Used

YOU SAVE MONEY USING "ARGUS" GOODS

WRITE US

**ARTHUR P. TIPPET & CO.**  
Agents for Canada MONTREAL

## SPENCER'S

ALWAYS



RELIABLE

Best Wool - Best Weave - Best Wear

**J H SPENCER & SONS**  
BURY ENGLAND

Canadian Agents: **ARTHUR P. TIPPET & CO., MONTREAL**

# INDEX TO ADVERTISEMENTS.

(SEE CLASSIFIED ADVERTISERS INDEX ON PAGE XXVI.)

Ambursen Hydraulic Construction Co.....	lxix	Farrel Foundry & Machine Co .....	xxxliii
Anderson, F. C.....	liv	Finch, Hermann.....	xxxix
Appleton Machine Co.....	vi	Fullner .....	xxvi
Atterbury Bros. Inc.....	lviii		
Baker & Shevlin Co.....	vii	Garland, M. Co .....	xii
Becker & Co.....	E.O.M.	General Supply Co. of Canada, Ltd .....	li
Beloit Iron Works.....	xiii	Gewerkschaft Sachtleben.....	xxxvi
Bentley & Jackson.....	viii	Gillespie, Geo. H. Co.....	lxi
Bertram, James & Son., Ltd.....	xix	Glens Falls Machine Works.....	iv
Bertram's, Limited.....	xiv	Green Bay Barker Co.....	xxi
Black-Clawson Co., The.....	xxxix		
Blethen, Hugh R.....	lix	Hamelin, The, & Ayers Co., Ltd.....	lvi
Bredt & Co., F.....	xlvii	Hardy, Geo. F.....	liv
Brunner, Mond & Co., Limited.....	lxvi	Harmon Machine Co.....	v
		Hay Knife Co., Peter, Limited.....	lvii
Canada Coating Mills, Limited.....	liii	Holyoke Machine Co.....	xvi
Canada Paper Co., Ltd.....	liii	Hooker Electrochemical Co.....	xl
Canadian Boomer & Boschert Press Co.....	lvi	Hough, R.....	lxii
Canadian Boving Co.....	xxxix	Howell Co., The.....	xlvi
Carthage Machine Co.....	xxiv		
Castle, Gottheil & Overton.....	lxvii	International Process Co.....	xlvi
Chicoutimi Pulp Co.....	E.O.M.		
China Clay Co.....	xlvi	Jeffrey Mfg. Co.....	iii
Christie, J. Co.....	lxii	Jenckes Machine Co.....	xvii
Christie, Limited, George.....	lxi	Johnson & Sons, Limited, C. H.....	xlv
Churchill & Sim.....	lviii	Jones, E. D. & Sons Co.....	1
Crookes, Roberts & Co.....	xlii		
Crossley, T. L.....	liv	Kimball, Herbert S.....	lv
		Klipstein & Co., A.....	xlvi
Dallyn, Jardine & Co.....	xlvii		
Dean, F. W.....	liv	Lawrence Machine Company.....	xxxv
DeCew, J. A.....	lv	Lawrence Pump & Engine Co.....	li
Dillon Machine Co.....	xiv	Lea, R. S. & H. S. Ferguson.....	liv
Dobler & Mudge.....	vi	Little, Arthur D. Inc.....	liv
Dodge Mfg. Co.....	iv	Lyford, Clark & Co.....	liv
Dominion Belting Co.....	xlvi		
		Mallandain, Albert E.....	xxix
Eaton & Brownell.....	lviii	Marx, J. & Co.....	v
Eastern Pipe and Construction Co., The.....	xlvi	Mardon, Alfred H.....	lvi
Emerson Mfg. Co.....	xxv		

## HYDRAULIC TURBINES

One unit of six with a total capacity of 13,100 Horse Power furnished for the new plant of J. R. Booth, Oitawa, Ontario. We build Turbines for any power for heads from 3 to 600 feet.

WRITE FOR CATALOGUE



**S. MORGAN SMITH CO.,**  
 YORK - PA.

McDougall, John, Caledonian Iron Works Co., Limited ..... xxviii  
 Milne, Jas., and Son ..... E.O.M.  
 Moore & White Co. .... xv  
 New Brunswick Pulp and Paper Co., Limited ..... lii  
 Northern Engineering Works ..... lxii  
 Northern Mills Co ..... lii  
 Pänzl Digester Lining Co. .... lii  
 Paper Makers Chemical Co. .... lvii  
 Parsons Trading Co. .... xxiv  
 Penman's Limited. .... xlvii  
 Perkins, B. F. & Son ..... xxxi  
 Phillips, S. C. & Co. .... xxxviii  
 Porritt & Son, Joseph ..... ii  
 Porritt Bros. & Austin ..... xlv  
 Prather, H. B. .... iv  
 Preston's Digester Lining Co., Limited ..... xx  
 Pringle, T. & Sons ..... liv  
 Pullan, E. .... l  
 Pulp & Paper Trading Co., The. .... lvii  
 Reddaway, F. & Co. .... l  
 Rice, Barton & Fales ..... ii  
 Riordon Paper Co., Limited ..... liii  
 Ryther & Pringle ..... xxxi  
 Sadler & Haworth ..... xlix  
 Sandy Hill Iron & Brass Works ..... vii  
 Scandinavian American Trading Co. .... xli  
 Scott, Ernest & Co. .... xxxvii  
 Sherbrooke Machinery Co., Limited ..... xviii

Smart-Turner Machine Co ..... lxi  
 Smith, S. Morgan, Co. .... xliii  
 Snell, Samuel Co ..... xlvi  
 Spencer, J. H. & Sons ..... xlii  
 Stebbins Engineering & Mfg. Co. .... lv  
 Sweezy, R. O ..... xxxvii  
 Swenson Evaporator Co. .... xxxvii  
 Taylor, J. A. .... lxi  
 Ticonderoga Machine Works ..... E.O.M.  
 Tippet, Arthur & Co ..... xxv - xlvj  
 Union Screen Plate Co ..... iii  
 Union Sulphur Co., The ..... lvii  
 United Wire Works, Limited ..... xxv  
 Valley Iron Works ..... xxxii  
 Vera Chemical Co ..... lviii  
 Voith, J. M. .... x  
 Walker, J. R. & Co ..... lviii  
 Wallace, Jos. H. & Co. .... lix  
 Walmsley, Charles & Co. .... xxii - xxiii  
 Wandel, Chr. .... xxxviii  
 Wandel Screen Mfg. Co. .... ix  
 Waterloo Engine Works Co., Limited ..... lx  
 Wertheim & Co., A ..... lx  
 Westbye, P. P. .... xi - xxi  
 West End Engine Works Co. .... xxx  
 Wilson, Paterson & Co. .... xxiv  
 Winn & Holland ..... lxii  
 Zarembo Co. .... E.O.M.

**KRAFT PULP**



**MADE IN SWEDEN**

The best Pulp for making

**KRAFT BROWN PAPER**

Sole Selling Agents, United States  
and Canada

**THE HOWELL CO.**

8-10 Wellington St., East

**TORONTO - CAN.**



**MAPLE LEAF**

**STITCHED COTTON DUCK**

**BELTING**

**DOMINION BELTING CO. LTD.**

**HAMILTON CANADA**

**HAVE YOU GOT YOUR COPY OF THE  
 PAPER MAKERS' POCKET BOOK?  
 SEE PAGE LIV.**

You can Purchase  
Thoroughly Up-to-date  
**Paper Mill Machinery**

and the Strongest Type of  
**FAST-RUNNING PAPER**  
**MAKING MACHINES**

FROM  
**Bertrams Limited**  
SCIENNES  
EDINBURGH

**C. H. JOHNSON & SONS, Ltd.**

WIRE WORKS, ST. HENRY, MONTREAL.

MANUFACTURERS OF

**Fourdrinier Wires, Cylinder Wires,  
Brass, Copper and Iron Wire Cloth, Dandy Rolls**

**PORRITT BROR. & AUSTIN**

Stubbins Vale Mills—RAMSBOTTOM—near Manchester, England

Manufacturers of every description of

**FELTS AND JACKETS FOR  
PULP AND PAPER MILLS**

Agents for Canada : C. H. JOHNSON & SONS, Ltd., ST. HENRY, MONTREAL



**We Manufacture** Wooden Water Pipe for Water Works Systems. Specially Made Pipe for conveying Chemicals. Continuous Stave Pipe for Power Plants. Sizes from 2' to 12' Diameter

**The Eastern Pipe and Construction Co.,**  
**Alexandria, Box 329 Ontario.**

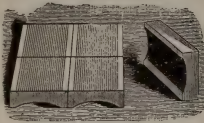

### Use Snell's Drainer Bottoms

They drain quickly and don't let the Pulp go into River. **No Dust. No Splinters. Clean Stock.**

*Send for Sample and Price.*

**Samuel Snell Co., - Holyoke, Mass.**

Cable Address:—"Kaolin, Manchester." A.B.C. Codes 4th & 5th Edition

# CHINA CLAY CO.

JOHN WILLIAMSON, Manager.

4 St. Anne's Square

**MANCHESTER, ENG.**

**MINES—Ruddle, Bojea, Colchester, South Ninestones, Tronance, St. Austen Cornwall.**

**CONTRACTORS TO H.M. INDIAN GOVERNMENT**

**Canadian Representatives—C. A. Meincke & Co., 222 Coristine Bldg., Montreal.**

## A. KLIPSTEIN & Co. Ltd.

(OF CANADA)

12 ST. PETER ST. - - MONTREAL

# SULPHATE ALUMINA

**CHINA CLAY, BLEACH and CASEIN  
 PAPER BLUE, both Basic and Acid  
 AURAMINE - RHODAMINE**

and all other Aniline Colors

Shades Carefully Matched in our Laboratory Mention Pulp & Paper Magazine

**New York Office - 129 Pearl Street**

**LAWRENCE PUMP  
AND ENGINE CO.**

P. O. BOX 70, DEPT. 10  
LAWRENCE :: MASS.

**CENTRIFUGAL PUMPS**

We make an exclusive specialty of High Efficiency Centrifugal Pumps for Paper and Pulp Mill. In one mill 49 of our Pumps are running, the customer writes— "Your Pumps are all giving perfect satisfaction."

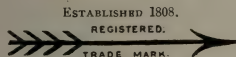
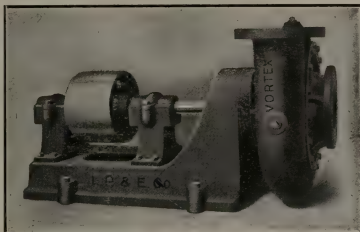

**FELTS** For Pulp and Paper Mills.

**JOSEPH PORRITT & SONS**

Agents for  
Canada  
and United  
States.

**HELMSHORE**  
Manchester, England.

All kinds  
Woollen, Lin-  
en and Cotton  
Cloths for  
Mechanical  
Purposes.

**F. BREDT & CO., 240 Water Street, NEW YORK.**

**PENMANS LIMITED**  
ST. HYACINTHE, QUEBEC

Manufacturers of  
**PULP AND PAPER MAKERS' FELTS,  
JACKETS, STRAINER CLOTHS, ETC.**

Special sizes and qualities made to order. Satisfaction guaranteed.  
**DALLYN, JARDINE & CO. TORONTO Selling Agents**

**CASTLE, GOTTHEIL & OVERTON**

**200 Fifth Avenue, New York**

AGENTS FOR

***Sulphite and Wood Pulp Mills***

Dealers in all kinds of Paperstock, Sizing, etc.

Correspondence Solicited.

THE PROCESSES AND APPARATUS  
THAT MADE "KRAFT PAPER'S" SUCCESSFUL



CABLE ADDRESSES  
KRAFTLICH, NEW YORK.  
INPROKRAFT, LONDON.

AMERICAN OFFICES  
5 BEEKMAN STREET  
NEW YORK, N. Y.

SOLE AGENTS IN NORTH AMERICA  
FOR  
CARL P. CARLSON, SWEDEN.  
EVAPORATORS AND LIQUOR SYSTEMS.

JULIUS PINTSCH, ACTIENGESELLSCHAFT, GERMANY.  
DIGESTERS, DIFFUSERS AND SPECIALTIES.

SWEDISH SYSTEM OF RECOVERY FOR  
TURPENTINE, ALCOHOL AND OTHER BY-PRODUCTS.

EUROPEAN OFFICES  
SALISBURY HOUSE,  
LONDON, ENGLAND.

INTERNATIONAL PAPER PROCESSING CO.  
ENGINEERS, CHEMISTS, PULP EXPERTS.

# “AMPHIBIA”



(WATERPROOF)



## Leather Belting

is the kind that costs you Less Per Day of Service and, therefore, the cheapest in the long run.

This “cost-per-day-of-service” basis is the only one to use when figuring out your belting costs. Our belts may cost a little more at first but they last longest. What’s more,—“AMPHIBIA” Belting is absolutely unaffected by moisture.

MADE ONLY BY

*Sadler & Haworth*

Tanners and Manufacturers.

MONTREAL  
511 William St.  
ST. JOHN, N.B.  
89 Prince William St.

TORONTO  
27 Melinda St.  
WINNIPEG  
244 Princess St.

VANCOUVER  
217 Columbia Ave.

For over thirty-five years the makers of the best leather belts.

Nearly FIFTY YEARS ago we introduced this Belt. IT HAS STOOD THE TEST OF TIME

2" to 24" in stock

Every Belt is  
Stamped with  
Trade-Mark.



Write or phone us

Beware  
of Imitations

SOLE MAKERS

F. REDDAWAY & CO.,

MONTREAL, CANADA.

**E. PULLAN,** 490 Adelaide St. W.,  
TORONTO

Largest Paper Stock Dealer in Canada

**RAGS AND PAPER STOCK GRADED TO SUIT MILL REQUIREMENTS**

**Correspondence Solicited.**

Edward A. Jones, President and Treasurer.

Wallace E. Bardwell, Secretary

**F. D. JONES & SONS CO., Pittsfield, Mass.**

Manufacturers of

**PAPER MAKING MACHINERY  
AND MECHANICAL ENGINEERS**

Beating Engines. Washing Engines. Mixing Engines. Bleaching Engines.  
Cooking Engines. Vertical and Horizontal Stuff Chests.

Jordan Engines of three sizes, either belt or direct-connected motor-driven ;  
fillings of Wagg Steel or stone type, three-part or plain.  
Dusting Machinery of all kinds.

SECOND AND ENLARGED EDITION

# THE PAPERMAKERS' POCKET BOOK

Specially Compiled for

PAPER MILL OPERATIVES, ENGINEERS, CHEMISTS,  
AND OFFICIALS

By JAMES BEVERIDGE

- ☞ This new edition contains more exhaustive chapters on Raw Fibrous Stock, such as Cotton and Linen Rags, Esparto, Bamboo, Megass or Crushed Sugar Cane, etc.
- ☞ The chapter on Wood Cellulose Manufacture by the Soda, Sulphate, and Sulphite methods has been amplified. Very complete information has been given of Soda Recovery, Causticising and Composition of Recovered Soda Liquors.
- ☞ A new but brief chapter has been added relating to Loading Materials.
- ☞ The chapter on Chemical Analysis has been enlarged.
- ☞ It will be found that the additional matter is given in concise form, is of a highly practical nature, and is not generally found in English text books.

PRICE, \$3.50

**BIGGAR-WILSON, LTD., TORONTO**



# VI-BALATA BELTING

Is made in all widths up to 50 inches, and in any thickness from 3 ply to 24 ply. Is absolutely waterproof and not affected by extremes of temperature. Has great strength and durability, and is practically stretchless.

A recent test made by the well-known Testing Engineers, Messrs. Kirkaldy & Sons, London, Eng., gives the following result :

**6-inch 4-ply broke at 13,000 lbs.**

OR

**9,000 lbs. per square inch**

**LARGE STOCKS CARRIED AT ALL BRANCHES**

---

---

SOLE AGENTS :

**THE GENERAL SUPPLY CO.,**

OF CANADA, LTD.

**356-58-60 SPARKS ST., - OTTAWA, ONT.**

115-125 Adelaide Street West, **TORONTO**

**WOODS WESTERN BUILDING, Cor. Market & Louise Sts., WINNIPEG, MAN.**

**FLECK BROS., LTD., 443 Pender St. West, VANCOUVER, B.C.**

## THE NORTHERN MILLS COMPANY

**Paper Manufacturers. Printing and Writing Papers.**

Super-Calendered, Velvet and Machine Finished Book, Litho and Antique Printing, Engine Sized Writing and Envelope Papers, White and Tinted Bond. Typewriter Papers (Glazed and Rough Finish). Writing Tablets and Envelopes.

Ask for "Canadian Bond," "Provincial Bond," "Adelia," and "Northern Mills."

**Head Office:**

**Montreal, 278 St. Paul Street.**

**Mills:**

**St. Adele, Que.**

## Genuine "KRAFT" Papers MADE IN CANADA

**THE NEW BRUNSWICK PULP & PAPER CO., LTD.**

**Springfield Mills, Millerton, N.B.**

**TORONTO, 182 Adelaide St. W.**

**MONTREAL, 404 St. Nicholas Bldg.**

## PANZL'S PATENTED LINING COMPOSITION

IS THE SAFEST AND BEST MATERIAL FOR

**LINING OF SULPHITE PULP DIGESTERS**

AND ACID RECLAIMING TANKS

**PANZL LININGS ARE SAFEST AND  
MOST DURABLE**

They are really acid-proof and practically indestructible.

All Digesters lined with Panzl's patented composition, now as tight and in as good condition after years of continuous use as they ever were, no leaks and no repairs.

Panzl Linings can be made considerably thinner than the other linings, thus increasing the capacity of the digesters.

The composition and the system of constructing of Panzl Linings are patented in all countries where wood pulp is being manufactured by the sulphite process. The PANZL U.S. Patents have been adjudicated to be valid in law and wholly independent of all prior patents relating to linings of digesters.

For information and estimates, address:—

**PANZL DIGESTER LINING COMPANY**

**505 Washington Ave., Muskegon, Mich.**

## The Riordon Paper Company, Limited

Fibre, Paper, Lumber.

MONTREAL - CANADA

News Paper, Hanging Paper, Wrapping Paper, Building Paper,  
Celebrated "Impervious" Spruce Sheathing and Sulphite Fibre for all  
kinds of Paper.

## THE CANADA COATING MILLS, Ltd.

GEORGETOWN, ONT.



Manufacturers of  
SURFACE COATED BOOK and LITHOGRAPHIC  
PAPERS COATED CARDBOARD and COATED  
BOXBOARDS of every description.

### "Chalk White" Coated Book Paper.

The best and whitest coated paper sold.

**ALL REGULAR SIZES AND WEIGHTS IN STOCK.**

Our Art Litho Cover Paper is stocked in four tints,  
2 sizes. 20 x 25 and 21½ x 28½. Samples gladly sent.

MONTREAL  
TORONTO

**CANADA PAPER CO.**  
LIMITED

WINDSOR  
MILLS, P.O.

# DIRECTORY

of

## Civil and Chemical Engineers

### T. PRINGLE & SON, Limited

Engineers and Architects

Plans and Specifications for Pulp and Paper Mills, Power Plants and other Industrial Works.  
**Coristine Bldg.**      **Continental Life Bldg.**  
**Montreal.**              **Toronto.**  
 Bell Tel.: M. 3890.              Tel.: M. 5917.

### R. S. LEA, and H. S. FERGUSON,

ENGINEERS

Pulp, Paper and Chemical Fibre Mills, Water Power Development and Transmission. Steam Power Plants.  
 Telephone Long Distance Up, 751.  
 405 DORCHESTER ST. West, MONTREAL

### Arthur D. Little Inc.

— LABORATORY OF —  
 ENGINEERING CHEMISTRY  
 93 BROAD ST., BOSTON, - MASS.

Our staff includes experts in Papermaking Chemistry  
 —Sulphite Mill Practice—Fuel Engineering.

### GEORGE F. HARDY, M. AM. SOC., M. E. M. CAN. SOC. C. E.

Consulting Engineer.

Paper, Pulp and Fibre Mills, Examination of Mill Properties, Water Power Developments.  
 Mutual Reserve Building, - 309 Broadway,  
 NEW YORK.

CHARLES E. EATON,      JAMES P. BROWNELL,  
 M. Am. Soc., M. E.      C. E.

### EATON & BROWNELL,

Consulting Engineers and Architects.

Paper, Pulp and Fiber Mills, Water, Steam and Electric Power Development, Examination of Properties, Consultation Reports.  
 SMITH BLDG.      WATERTOWN, N. Y.

### F. W. DEAN, Mill Engineer and Architect

(Formerly of Dean & Main)  
 Exchange Building 53 State Street,  
 BOSTON, Mass.

Paper and Pulp Mills. Steam, Hydraulic and Electrical Developments. Examinations and Reports of Projects.

### T. LINSEY CROSSLEY

Engineering Chemist

PULP AND PAPER  
TECHNOLOGY

318 Lagauchetiere St., W., Montreal

### FOREST ENGINEERS

FOREST SURVEYS      LOGGING MAPS

WATER POWER      TIMBER ESTIMATES      WATER STORAGE

CLARK, LYFORD & STERLING  
 1331 Real Estate Trust Bldg., Philadelphia  
 CLARK & LYFORD      LYFORD, CLARK & LYFORD  
 403 Crown Bldg.      206 Board of Trade Bldg.  
 Vancouver.      Montreal.

### FRED. C. ANDERSON

Mill Engineer

20 years practical experience in paper, ground wood and chemical pulp making. Steam Hydraulic and Electrical development, Examinations and Reports on both old properties and new projects.

9-10 Strickland Bldg., CARTHAGE, N. Y.

ENGINEERS SHOULD WRITE  
 THE PUBLISHERS FOR RATE  
 OF CARDS ON THIS PAGE.

**PULP  
PAPER  
POWER** JOSEPH H. WALLACE & CO.  
INDUSTRIAL ENGINEERS.  
TEMPLE COURT BLDG. NEW YORK.  
SALISBURY HOUSE, LONDON, E.C.  
CABLES, TRIPLEX, N. Y., TRIPLEX IS, LONDON.

**J. A. De CEW**

M.A. INST. CHEM. ENG.  
A.M. CAN. SOC. C.E.

Paper Mill Analysis.

Pulp Testing

Investigations.

**Chemical  
Engineer**

Sulphite Fibre

Soda Fibre

Reports

**Canadian Express Building MONTREAL.**

**HERBERT S. KIMBALL**

M. Am. Soc. C.E.

**CONSULTING ENGINEERS**

**Metropolitan Building**

**R. O. SWEEZEY**

A.M. Can. Soc. C.E.

**QUEBEC CITY**

**PULP AND PAPER MILLS**

Design and Reports

Steam and Water Power Development

**SCIENTIFIC FORESTRY**

Limit Cruising

Water Storage

Power, Lighting, Heating, Ventilating and Drying.—Complete New Plants, Improvement of Old Plants;  
Plans, Specifications, Contracts, Estimates, Tests, Appraisals, Inspections and Reports.—Pulp, Paper,  
Box Board and Coating Mills.

Lowest

Possible

Operating Cost.

**H. B. PRATHER,**

**CONSULTING ENGINEER,**

ROCKFELLER BLDG., CLEVELAND, O.

Guaranteed

Results.

**HUGH R. BLETHEN**

**21 PARK ROW, - - - NEW YORK, N.Y.**

Traveling Cranes - Overhead Tramways - Trolleys and Chain

Hoists for Paper and Pulp Mills - Power Houses.

**Stebbins Engineering & Mfg. Co.**

**WATERTOWN, N.Y.**

MANUFACTURERS OF

STEBBINS' ACID SYSTEMS, SULPHUR BURNER

DIGESTER LININGS, RECLAIMERS, ETC.

Engineering Department  
under

Mr. T. L. TOMLINES

Plans, Estimates and Specifications for Paper,  
Pulp and Fibre Mills,

Water Power and Hydro-Electric Developments



# LEUNIG PAPER SCALES

Showing correctly at a glance, by weighing a single sheet, the weight of a ream of Paper of any size, containing either 480, 500, or 516 sheets.

Can also be made to indicate in addition to the English weight, the weight in Kilogrammes.

Illustrated Price List on Application.

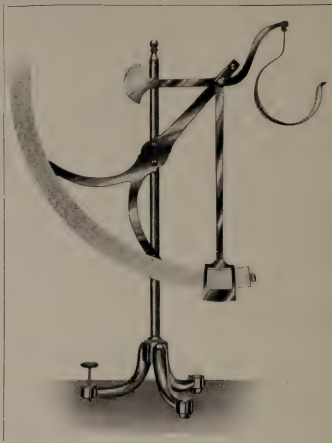

$\frac{1}{2}$  to 80 lbs.

**Price,**  
**Ten Dollars**  
F.O.B., London

$\frac{1}{2}$  to 120 lbs.

**Price,**  
**Fourteen Dollars**  
F.O.B., London

Illustrated Price List on Application.

**Alfred H. Mardon** 150 Shaftesbury Ave. **London, Eng.**

# PULP PRESSES

AND ACCESSORIES

**CANADIAN BOOMER & BOSCHERT PRESS Co., Ltd.**

18 TANSLEY STREET, MONTREAL

"LACHUTE FELTS"

Bell Tel. No. 23

**The Hamelin & Ayers Co., Limited**

LACHUTE MILLS, P.Q.

MANUFACTURERS OF EVERY DESCRIPTION OF

**FELTS** FOR PAPER AND PULP MILLS

"The Best are the Cheapest."

**BARKER  
CHIPPER  
PAPER-CUTTER**

**MACHINE** *Of Every*  
**KNIVES** *Description*

**THE PETER HAY KNIFE CO., LIMITED, GALT, ONT.**

**The PULP & PAPER TRADING CO.**

TEMPLE COURT BUILDING, NEW YORK CITY.  
DEALERS IN

**Paper and Pulp of All Kinds.**

Prices and Samples on Application.

REGISTERED



JOHN KNIGHT, Pres. C. K. WILLIAMS, Treas. C. H. KNIGHT, Sec.

**Paper-Makers Chemical Co.**

FROM MINE TO MILL

**ENGLISH CHINA CLAYS  
MANUFACTURERS**

**Excelsior Felt Cleaner**

GBB Brand China Clay is  
a natural pure white, no artificial tinting  
Unsurpassed for  
coating, bleaching, or fine papers.

Superior Rosin Size  
Superior Casein Size

**EASTON, PA., U.S.A.**

# **The Union Sulphur Company**

**Producers of the Highest Grade Brimstone on the Market**

Absolutely free from Arsenic, Selenium or Tellurium

**The Largest Sulphur Mine in the World**

**CALCASIEU PARISH, - LOUISIANA**

**Main Offices : Whitehall Bldg., 17 Battery Place**

**NEW YORK**

**WE GUARANTEE OUR SIZINGS TO BE ABSOLUTELY CLEAN  
OUR VERA PAPER SIZE**

is purest, strongest and highest free rosin size made. We can furnish you with an ideal rosin size and patented apparatus to use same.

**OUR VERA MILL SIZE**

is the best soluble paper makers' rosin size made. Ready to use in cold or warm water in the ordinary way without apparatus. Gives better satisfaction and is more economical than mill made size.

Our sizings are cleaned by our new patented process and we guarantee this size to be absolutely clean, without the least speck of impurity in the same, preventing thereby black specks in the paper. We are shipping our size in barrels or tank-cars.

**VERA CHEMICAL COMPANY**

Main Office and Western Factory  
NORTH MILWAUKEE, WIS.

Eastern Factory  
STONEHAM, MASS.

**J. R. Walker & Co.**

Importers and  
Packers of

**GRADED RAGS, PAPER STOCK  
ROPE BAGGING, ETC.**

WAREHOUSE, 35 COMMON ST., MONTREAL.

Also Manufacturers of Roofing and Building Papers. Leatherboard and Friction Board

Mills at Sault au Recollet, P.Q.

**ATTERBURY BROTHERS, Incorporated.**

*Importers and Exporters.*

**Wood Pulp, FOREIGN AND DOMESTIC Rags AND Paper Stock**

Potter Building, 145 Nassau Street, New York City.

Cable address "AFFECTIVE," New York.

**CHURCHILL & SIM**

29 CLEMENTS LANE, LONDON, E.C.

And at Manchester

**WOOD PULP AGENTS**

Telegraphic Address:—  
"CHURCHILL, LONDON."

A.B.C. CODE  
5th Edition

# A. WERTHEIM & Co.

## HAMBURG

---

---

IMPORT AND EXPORT ALL KINDS OF

***Sulphite,  
Soda and  
Mechanical***

# WOOD PULPS

---

---

**OFFICES AT:**

CHRISTIANIA (Norway) .. Kirkegaden No. 20.  
GOTHENBURG (Sweden) .. Lilla Kyrkogatan No. 20.  
MANCHESTER .. .. Guardian Buildings (opposite Exchange).  
LONDON .. .. . 77a Queen Victoria Street, E.C.  
PARIS .. .. . Rue de Londres No. 29.  
ANGOULEME (France) .. 43 Rue Louis Desbrandes.  
LYONS .. .. . 54 Cours Gambetta.  
MILAN .. .. . 24 Via Solferino  
TOLOSA (Spain) .. .. 18 Calle San Francisco.  
NEW YORK .. .. . 99 Nassau Street.  
ST. PETERSBURG .. .. Little Podjascheskaja House, 4, Qu. 16.

---

---

**Telegraphic Address:**

**“WERTHEMO, HAMBURG.”**

*Over 70 sold since April, 1911*

When it comes right down to brass tacks, orders, and particularly *repeat* orders, are the best indication of the quality of a machine.

## Quiller Centrifugal Screens

have been manufactured by us in Canada only since last spring. Already some 70 of the machines have been placed and we are busy filling the repeat orders our earlier installations have brought in.

**The Quiller Screen** has been tried out for many years in European mills. Of late years numerous installations have been made in the United States and Canada. Not only has it demonstrated its complete adaptability to American conditions but it has been acknowledged without superior in screening capacity and in economy of operation.

**With Proved Maximum Capacity.**

Horizontal Type—12 to 14 tons Ground Pulp.

Vertical Type—12 tons Ground, 15 tons Sulphite Pulp.

**Guaranteed Minimum Power Consumption.**

3/4 H.P. per ton capacity.

*Write us for full information and let us refer you to an installation in your neighborhood.*

**The Waterous Engine Works Co.,**  
Limited  
Brantford, Canada.



**Geo. Christie Ltd.** - - **Glasgow  
Scotland**

## **FOURDRINIER MACHINE WIRES**

**Unequalled for Strength, Smoothness and Long Life**

## **CYLINDER COVERS**

**Canadian Agent :**

**J. A. Taylor, 22 St. Francois Xavier St., Montreal**

## **CANADIAN TALC FILLER**

**GEO. H. GILLESPIE COMPANY**

**MADOC - - - ONTARIO**

*The only Manufacturers of Paper Filler in Canada.*

Our Filler is used in Canada, United States, England, Germany,  
Austria, Holland, Russia and Scandinavia.

## **AMBURSEN HYDRAULIC CONSTRUCTION CO.,**

**OF CANADA, LIMITED,**

**405 Dorchester St. W. - Montreal.**

(Associated with the Ambursen Hydraulic Construction Co., of Boston, Mass.)



### **Concrete Steel Dam**

**OF THE**

**MISSISQUOI PULP CO.,**

**Sheldon Springs, Vt.**

Mid-channel. height 40 feet  
Total length 270 feet (only  
180 feet shows in the pic-  
ture, the remainder being  
concealed at the left.)

Dam specially designed to  
withstand heavy ice gorges.  
Factors of safety are calcu-  
lated for a 12-foot flood.

**IF YOU HAVE A DAM TO BUILD, WRITE US NOW.**

Every Grade of Waste for  
Paper Making.

# R. HOUGH,

LONDON, England.

Agent for Canada and U. S.,

**THE J. CHRISTIE CO.**

5 King St. West, TORONTO, Canada.

STEAM PUMPS  
CONDENSERS  
VACUUM PUMPS  
TRIPLEX POWER PUMPS  
CENTRIFUGAL PUMPS

The Smart-Turner  
Machine Co., Limited

HAMILTON

CANADA

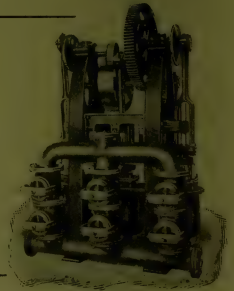

**Cranes and Hoists for Paper Mills and Power Plants**

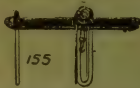

155



121C



158

NORTHERN ENGINEERING WORKS, 25 Chene Street - DETROIT, Mich.  
NORTHERN CRANE WORKS, LTD., Manufacturers for Canada, Walkerville.

## WINN & HOLLAND, Limited

MONTREAL

PULP AND PAPER CHEMICALS. Sole Agents for:

**BRUNNER, MOND & CO'S.**

SODA ASH, BLEACHING POWDER,  
SAL SODA, CAUSTIC SODA, &c.



# THE JONASSEN PULP REFINER

For the Reclaiming of Ground  
Wood and Sulphite Screenings

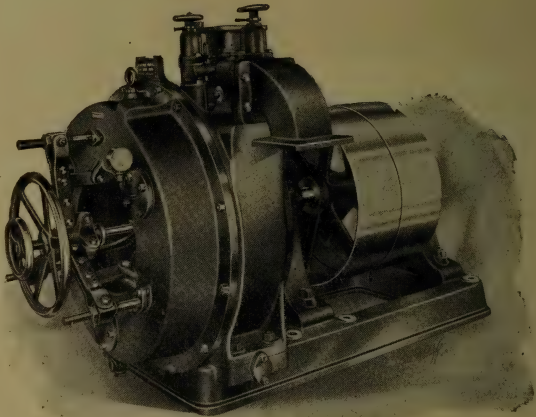

With this Refiner you save all your Ground Wood and Sulphite Tailings or Screenings, which now go to waste.

Capacity of Machine: From 8 to 10 tons of Screenings a day.

Power required to operate same: 20 horse power.

Write us for prices and further information.

## Rice Barton and Fales Machine and Iron Co.

WORCESTER, MASSACHUSETTS, U.S.A.

# JEFFREY PULPWOOD CONVEYERS AND STACKERS



Traveling Stacker  
Boom Conveyor,  
handling 200 Cords  
in 10 hours.

Storage extended by  
Skidways from top of  
Boom. A Maximum  
of Storage with a Mini-  
mum of Outlay.

Designers and builders of Elevating, Conveying and Power Transmission Machinery for all purposes in Pulp and Paper Mills. Pulp Lap Shredders, Chains, Cable wheels, Sprockets, Industrial Locomotives, etc.

*Our latest Catalogs are always available. Write for free copies.*

## The Jeffrey Manufacturing Company

Canadian Main Office and Works—  
MONTREAL

Winnipeg Representatives—  
N. J. DINEEN & CO.

E. J. WELCH, *President and Managing Director*  
HENRY W. S. DOWNS, *Superintendent*

EMMONS CROCKER, *Vice-President*  
A. S. MORSE, *Secretary and Treasurer*

# SCREEN PLATES



The "Union" Bronze (best phosphorized cast metal) Plates for Sulphite Mills. The Standard Rolled Brass Plates. The "Union" Cast Metal Suction Plates.

We carry a large stock of blanks of the various sizes in both metals and can fill all orders promptly.

Old plates reclosed and recut by our process are practically as good as new and give better results than by any other process.

## Union Screen Plate Co. of Canada, Limited

FACTORY: LENNOXVILLE, QUEBEC.

OFFICES: Lennoxville, Quebec, and Fitchburg, Massachusetts, U. S. A.



# Glens Falls Machine Works

GLENS FALLS, N.Y.



Sole Manufacturers of

**Tromblee & Paull Rotary Sulphur Burner**

**The Moore Rotary Screen**

**The Reynolds Screen**

Also Manufacture

**Cedar Point Foundry Grinders**

**Improved Standard Grinders**

**Improved Wet Machines**

**Rotary Pumps, etc.**

Write for Particulars and Specifications—they are free.

# DODGE

## Transmission

## Machinery

### High Grade Only

**Shafting, Hangers, Pulleys,  
Friction Clutch Pulleys.**

## DODGE MANUFACTURING CO.

640 ST. PAUL ST.  
HAYMARKET SQUARE

**MONTREAL**

LIMITED

Telegrams :  
"CALENDER, BURY"

Telephone :  
NUMBER 340

# Bentley & Jackson,

Limited

PAPER MAKERS'

.. ENGINEERS ..

BURY, - - ENGLAND

*SPECIALITIES.*

MODERN HIGH SPEED NEWS PAPER  
MAKING MACHINES

SINGLE CYLINDER PAPER MAKING  
MACHINES

The NEW "*MARSHALL*" *PATENT REFINING ENGINE*, with separate adjustment to cones and discs, and our Patent Ball Thrust Bearing.

---

**APPLY FOR PRICES.**

---

## THE EDDY PAPER TESTER

Will register the breaking strength of paper in pounds per square inch—a recognized standard the world over.

**\$15.00 net**  
postpaid.

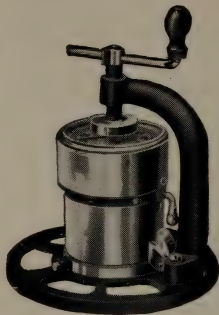

Is provided with an adjustment whereby the user can reset same, if necessary. Will do the work of higher priced machines and do it quicker. 6 inches high,

### DOBLER & MUDGE

BALTIMORE, MD., U.S.A.

— THE BEST —  
**JORDON ENGINE**  
IS BUILT BY THE

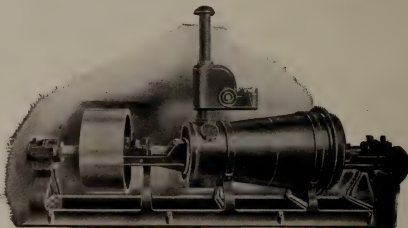

### APPLETON MACHINE CO.

APPLETON, WIS.

SEND FOR PARTICULARS

# J. M. VOITH

*Engineering Works and Foundries*

HEIDENHEIM  $\text{o}/\text{Brz.}$  (Wurt.)

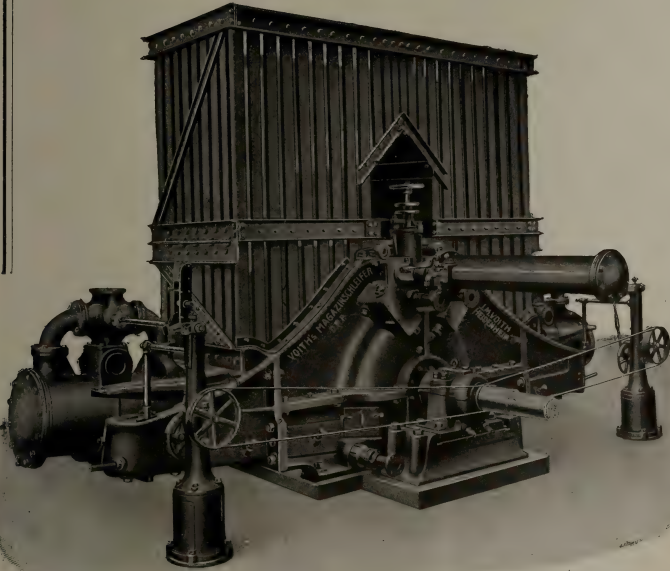

## VOITH'S MAGAZINE GRINDER

Patented in all principal countries.

Automatic Feeding and Reversing of Presses. 1 Grinder consume up to 1000 H.P. Of more than 50 apparatus ordered, 25 already delivered and working most satisfactorily.

SPECIALITIES :

COMPLETE MACHINERY FOR  
WOOD PULP, PAPER **MILLS**  
AND SULPHITE

Branch Office for Canada and U.S.A., 1008 Fifth Ave. Bldg., New York.

Representative: H. F. STORRER, C.E.

**J. Marx & Co., = = London, E.C., England**

Double Beaters with 1 Basalt Lava Roll and 1 Steel Roll in Concrete Beater Troughs, greatly improve quality of paper, especially News.

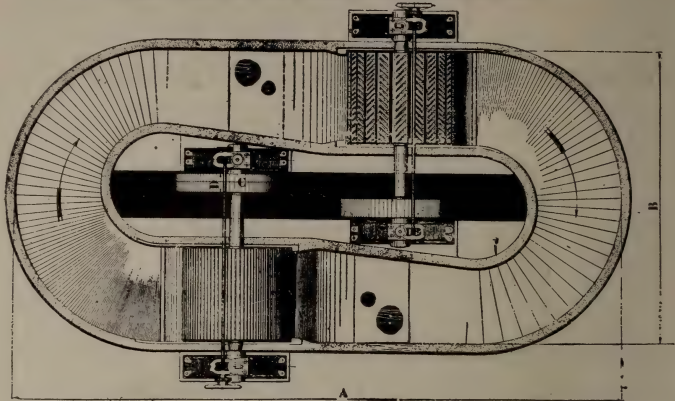

**SPECIALITIES:** Margalt Suction Rolls, Basalt Lava Stone Beater Rolls, Stone Wet Press Rolls, Basalt Lava Pulp Refiners for Screenings.

Canadian  
Representative

**Judson A. DeCew**

Canadian Express  
Building

**Montreal**

*The*

## Harmon Incline Screening System

- Will give greatest capacity.
- Will give cleaner stock.
- Will save power.
- Will save labor.
- Does not require use of Rakers.

Write us for full descriptive Catalogue and testimonials from the best mills in the country.

**HARMON MACHINE COMPANY**

**WATERTOWN, N. Y., U. S. A.**



OTTO WANDEL  
President

HERBERT H. MILLER  
Treasurer

# Wandel Screen Manufacturing Co.

WALPOLE, MASS., U.S.A.

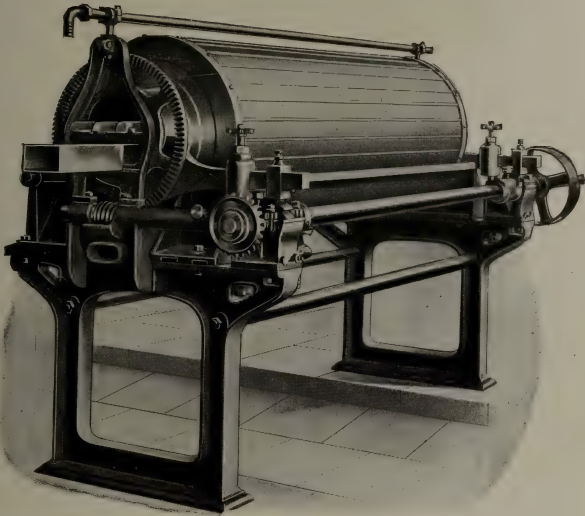

MANUFACTURERS OF THE

Quick Delivery.

Write for Catalogue  
and list of users.

We have no author-  
ized Agents in  
Canada.

## WANDEL ROTARY SCREEN

Over 200 Wandel  
Screens have  
been built and sold  
by us in the States  
within two years.

SUPERIOR CONSTRUCTION

THE SANDY HILL IRON AND BRASS WORKS, HUDSON FALLS, N.Y.

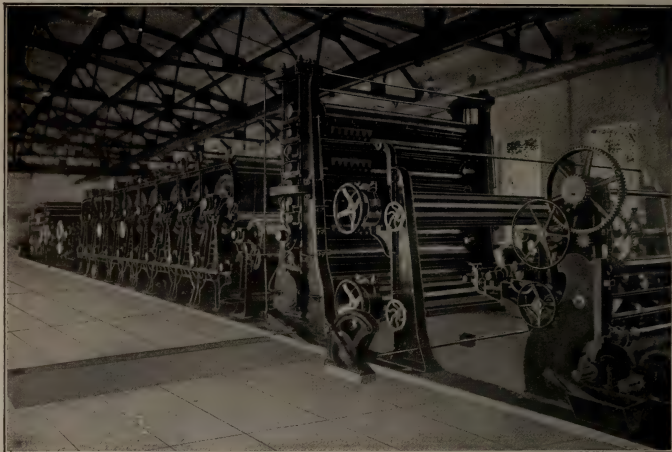

130" HARPER FOURDRINIER PAPER MACHINE.

The ::

# West End Engine Works Co.

PAPERMAKERS'  
ENGINEERS

- - - EDINBURGH

Specialists in all kinds of  
Papermaking Machinery

Duplex, Angle and Square Cutters, Vickery's Laying Machines,  
Improved Umpherston Beaters, &c., &c.

PRICES ON APPLICATION

Telegrams : West End, Edinburgh

## The Improved "RUTH" Centrifugal Pulp Screen

To suit different conditions the "Ruth" is built as shown in the illustration, or with Steel Mitre Gears in a cast iron casing, independent of the footstep and running in oil, insuring long life of the gears.

It is also built **without gears**, using top pulley or motor drive. In this construction the screen plate sections can quickly be taken out and replaced through side doors.

All parts are easy of access, and no clogging of inlet or plates can take place.

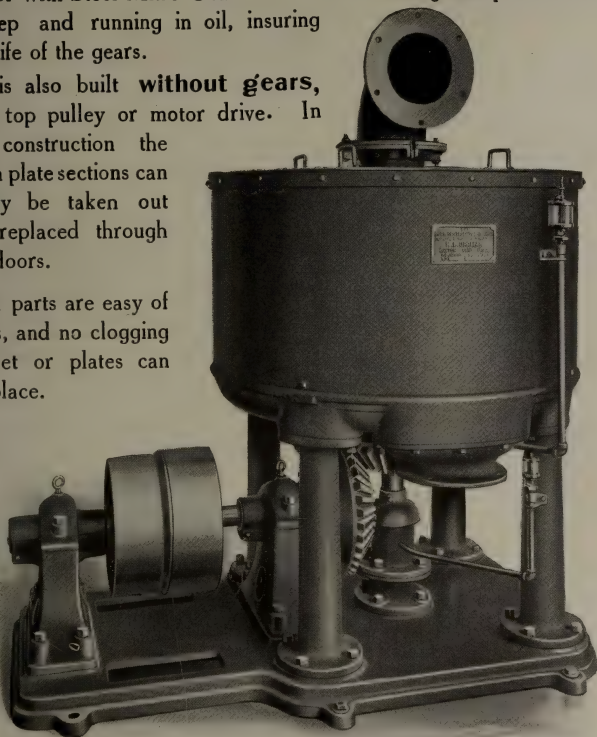

Other prominent features are—

- Simplicity of Construction.
- Small amount of power required.
- Great capacity and Low cost of maintenance.
- Lowest amount of fibre with the tailings.

In these respects this Screen is NOT surpassed by any other Screen in the market.

**P. P. Westbye, M.E., Peterborough, Canada**



**MOVABLE CRANE  
PULP LOG  
STORAGE SYSTEM  
AND UNLOADER**

---

---

**The M. Garland Company**

BAY CITY, MICHIGAN

**Inventors of the Cable Conveyor**

# Have You Heard the Facts About The Beloit Machines?

---

---

One Fourdrinier built for 500 feet has run 615 feet, and averages 550 feet and makes 72,000 lbs. of print in 23 hours, 110 inch trim.

Another, built for 350 feet, for manillas, is running 490 feet every day on print.

Two others, built for 250 feet on book, are now speeded up to 340 feet on book.

A cylinder machine built for 40 tons of strawboard has made 89 tons in 23 hours, and averages 76 tons per day, dryers are 116 inch face.

---

---

## Beloit Iron Works

BELOIT, WIS., U.S.A.



# DILLON MACHINE CO

BUILDERS OF

## PAPER MILL MACHINERY

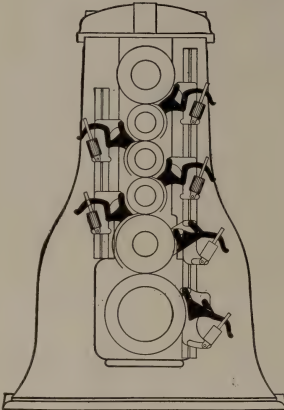

*DILLON DOCTORS  
AND  
FEEDS*

*DILLON MACHINE CO.  
LAWRENCE MASS.*

Beating Engines  
 Washing Engines  
 Jordan's Three Sizes—  
 Single, Double & Triple  
 Stuff Pumps, with  
 Dillon Patent Valve  
 Seating  
 Brannan Patent Paper  
 Folders  
 Horizontal and Vertical  
 Stuff Chests  
 Single and Double Paper  
 Cutters  
 Backstands  
 Plates, Knives and Bars

**DILLON  
 PATENT  
 DOCTORS  
 AND FEEDS  
 MADE IN  
 CANADA  
 BY THE  
 SHERBROOKE  
 IRON WORKS,  
 SHERBROOKE, P.Q.**

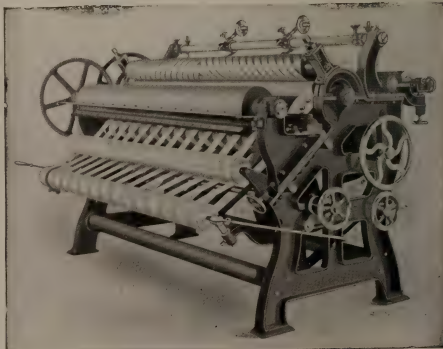

**LAWRENCE, MASS., U.S.A.**

---

---

# THE MOORE & WHITE CO.

ENGINEERS, FOUNDERS, MACHINISTS

PAPER MACHINE BUILDERS

Inquiries solicited and given prompt and careful attention.

Specifications and estimates for paper and pulp machinery on either new or repair work cheerfully given.

Quality guaranteed strictly high-grade



Office and Works, North Philadelphia Station, P. R. R.  
Philadelphia, U. S. A.

PAPER MACHINES FOR ALL GRADES OF PAPER

ALL GRADES OF BOX BOARDS

ROOFING, FELT AND BUILDING PAPERS

---

SATURATING AND ASPHALT COATING MACHINERY

“M & W” FRICTION CLUTCHES

AND “M & W” VARIABLE SPEED CHANGES

PRINTING MACHINES

FOR FLOOR CLOTH AND LINOLEUM

*Bulletins and information on any of the above subjects sent on request.*

---

---

# HOLYOKE MACHINE COMPANY

HOLYOKE, MASS., U.S.A.

MANUFACTURERS OF

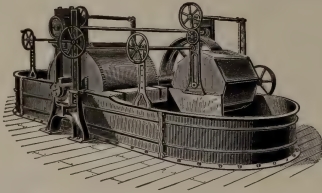

Washing and Beating Engines with Patent Double Hoist and Tubs of either wood or iron.

Hydraulic Pumps and Presses.

Rag Cutters and Rag Dusters.

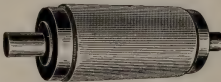

Cotton and Paper Rolls with Patent Fastenings.

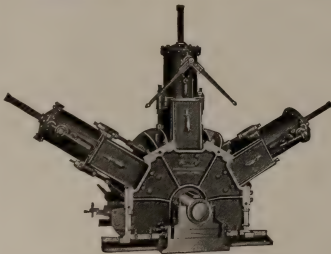

Patent Improved Wood Pulp Grinder.

Elevators, Rotary Fire Pumps and Friction Gearing.

Gears Accurately Spaced and Planed  
Shafting, Pulleys and Mill Work.

Machinery for Wood Pulp and Paper Mills.

Vertical and Horizontal Water Wheels with Flumes and all connections.

Wood Barkers, Wood Chippers and Wet Machines.

## Newest Designs

AND

## Highest Efficiency

Calenders. All kinds of Super-Calenders, Friction Calenders and Platers.

Chilled Iron Rolls.

Special Machinery

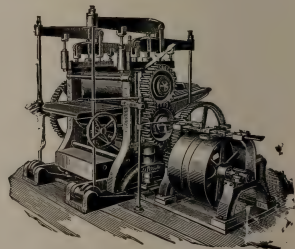

**Description and Estimates Furnished; also Gear List and Catalogs sent on application.**



# James Bertram & Son,

LIMITED.

LEITH WALK - EDINBURGH

---

## “LEITH WALK”

### PATENT HALF DRUM STRAINER

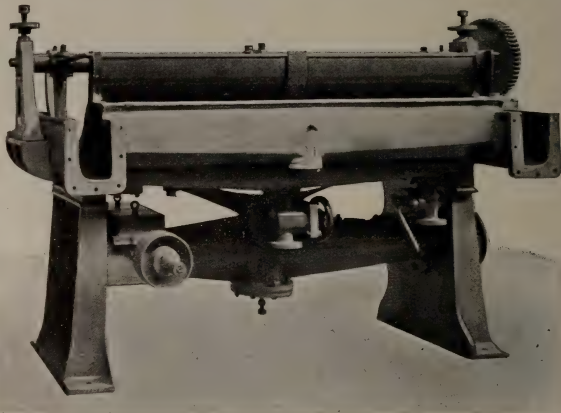

#### *ADVANTAGES :*

Enclosed Self Lubricating Driving Gear  
Stroke can be altered whilst Strainer is at work  
Plates can be cleaned in a few minutes without removal  
Noiseless in action, with small cost in upkeep  
Great capacity with upward flow of Pulp

---

Telegrams : “Bertram, Leith”



# STRAIGHT FACTS

## THE \_\_\_\_\_ PNEUMATIC SAVE-ALL \_\_\_\_\_ IS A SUCCESS

Its success has been widely recognized and it is now the standard means of saving waste.

Its service is not limited to ground wood or to sulphite waste, but includes the entire range of pulp and paper waste water.

It is equally successful with fine and coarse stocks, saving up to 90% of the waste fibres (and even more). It is a success when fibre only is supplied to it, and when the fibre is mixed with large percentages of filler. In the latter case (when so desired) it saves fibre and filler together.

In this save all, the waste stock, which would otherwise escape, is caught and held upon a revolving cylinder mold by pneumatic suction only. With this action comparatively coarse screens give vastly better results than are possible (even with the finest screens) on an ordinary pulp thickener.

Yet we can—and do—use excessively fine screens because there is no mechanical wear upon them in this device. With these screens we save virtually all the waste.

Yet even with these fine screens this save-all possesses very large capacity—200,000 to 300,000 gallons a day—because the filtered water is forced through by the same pneumatic action that leaves all solids on the screen.

## MONEY-SAVING MILL EQUIPMENT

Every machine we make is a money-saver. It begins to save money as soon as it is put into service, and that is why you see, in a rapidly increasing proportion of the mills, not only our Pneumatic Save-All, but other types of our machinery also. Re-orders for more save-alls and orders for wet machines and our other machinery from users of the save-all are now a very considerable part of our business.

*This fact is conclusive proof that the claims we make for these machines are fully borne out by the machines themselves.*

**Pneumatic Save-Alls  
Pneumatic Thickeners**

**Pneumatic Filters  
Wet Machines**

CORRESPONDENCE INVITED

**Sherbrooke Machinery Co., Ltd.**  
SHERBROOKE, P.Q.

# RENOLD PATENT SILENT CHAIN

## WHAT USERS THINK

Messrs. Jones & Glassco, Montreal  
 Montreal, Feb. 8, 1909

### RE RENOLD SILENT CHAIN DRIVE.

GENTLEMEN,—In reply to your inquiry of Jan. 30th, I may say that the Renold Silent Chain Drives we have installed are giving every satisfaction.

Our first drive was installed to replace a 12 in. belt which was giving us trouble on account of short centres; this chain has run continuously for four years without the slightest trouble.

Our second drive was installed on a mixing machine doing heavy duty and which had previously broken up two sets of spur gearing; this chain has run over three years with no sign of wear yet.

Our third drive was installed on a calendaring machine after breaking two sets of helical gears, and this has been so successful that we are now installing two more similar drives.

I would be perfectly willing to make an appointment with any person genuinely interested and show him the drive in operation.

*The above comes from one of the largest manufacturers in Montreal and is signed by the Mechanical Superintendent. Up to the present (1911) these drives have not received repairs of any kind.*

So satisfactory has their experience been that they are ordering (for a new extension) Renold Chain Drives throughout, transmitting about 400 H.P.

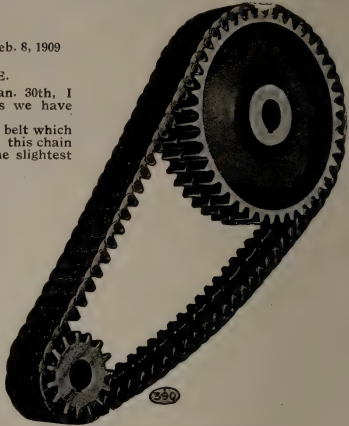

Write for Catalogue

**JONES & GLASSCO** Sole Canadian Agents **MONTREAL**

REGISTERED

# J. H. Horne & Sons

COMPANY

Lawrence

Mass.

— MANUFACTURERS OF —

## PAPER MILL MACHINERY

Fourdriniers  
 Cylinders and  
 Wet Machines  
 Improved Horne Engines

Horne Jordan Engines  
 Doubled Bevelled Roll Bars  
 Horne Friction Cullers  
 Barbed Jordan Bars

— SEND FOR CATALOGUE —

# THE LITTLE CHUTE PULP CO.

MILLS AT BUCHANAN, WIS.  
DAILY CAPACITY 50 TONS

LITTLE CHUTE, WIS.,

Mr. J. H. Taylor, V. P.

March 31, 1909.

McCartney National Bank,

Green Bay, Wis.

Dear Sir:

Answering your inquiry of the 30th inst. with reference to New Barker Machine, made by the Green Bay Foundry & Machine Works of Green Bay, will say, we installed one of their barkers in our mill here on a 60 days' trial with guarantee as to its saving of wood and cordage with the old style of barkers. During the 60 days trial, we gave this barker a most thorough and severe test, covering the parts named in their guarantee, and have decided that the machine will do all that is claimed for it, in the saving of wood and in amount barked.

We feel sure that the machine will pay for itself in less than 6 months' time. On Spruce wood it has no equal that we know of.

We have bought the machine put in on trial and ordered one additional machine to be delivered as soon as possible, for our mill here, also ordered one machine for the Outagamie Paper Company at Kaukauna.

Mr. J. C. Kimberly and Mr. Peter Thom, after looking into the merits of the machine here, tell me, they have ordered one machine for their mill at Kimberly and two for Quinnesec.

Any further information you may want; we will be very glad to give it.

Very truly yours,

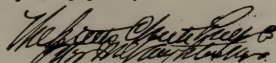

**THE GREEN BAY BARKER CO.**  
Green Bay, Wis.

**WALM**  
**High-speed Paper**

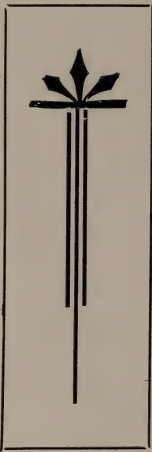

175 INCHES

**MAKING PAPER**

**600 FEET PER**

without Friction Clutch

**CHARLES WALM**  
**BURY, LA**

Estimates Given for Complete Paper-Making Plants.

**Sole Agents for Canada : C. H. Johnson**

# SLEY'S

## making Machines

WIDE ARE

ER AT OVER

ER MINUTE

s or Gear Wheels

### SLEY & CO., LTD.

### CASHIRE

odes: McNeill's (1908 Edition) Western Union, Bedford  
McNeill's A. B. C. 5th Edition  
Cables: Pumps, Bury

Sons, Ltd. - St. Henry, Montreal

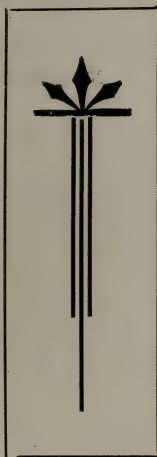



# Wilson-Paterson Co'y



127 BOARD OF TRADE BLDG., MONTREAL.

Agents for the United Alkali Co. of England

## **OFFER TO THE TRADE:**

Caustic Soda 60° to 78° Soda Ash, Caustic Potash, Sal Soda, Silicate of Soda, China Clay, Rosin size and a full line of Rosins, direct shipment from the south.

**Contracts made for regular supplies.**

# PARSONS TRADING COMPANY

EXPORTERS OF PAPER TO ALL PARTS OF THE WORLD

20 VESEY STREET, NEW YORK

BRANCH OFFICES AT

LONDON

SYDNEY

MELBOURNE

WELLINGTON

CAPE TOWN

BOMBAY

HAVANA

MEXICO, D.F.

BUENOS AIRES

**CORRESPONDENCE WITH MILLS SOLICITED**

# THE CARTHAGE CHIPPER

WILL INCREASE YOUR CHIPS. WILL  
DECREASE YOUR SAWDUST. By virtue  
of its Design and its Patent Feed Spout it takes a  
MINIMUM AMOUNT OF POWER.

---

Ask Anglo- Newfoundland Development Co.  
Ask Laurentide Pulp and Paper Company.  
Ask The Riordon Paper Company, Limited.

---

OR WRITE

**CARTHAGE MACHINE CO.**  
**CARTHAGE, N.Y.**

# Pulp and Paper Magazine of Canada

A Magazine devoted to the interests of Canadian Pulp  
and Paper Manufacturers and the Paper Trade.

SUBSCRIPTION PRICE: \$2.00 a year. Single Copies, 20 cents.

The Pulp and Paper Magazine is published on the second Tuesday of each month. Changes of advertisements should be in the Publishers' hands not later than the 1st of the month, and, where proofs are required, four days earlier. Cuts should be sent by mail, not by express.

PUBLISHERS:

BIGGAR-WILSON, LIMITED,

Confederation Life Building, Toronto, Canada

## Prospect For Canadian Paper.

The prospect of large quantities of newsprint being added to the daily output through the large new mills and extensions which are nearing completion in Canada does not appear to be having any depressing effect, either on prices or demand. The trade has been particularly active, both in this country and the United States. Indeed, such a heavy increase to the paper production could not come at a better time, so far as its effect on the market is concerned, than this year. In the United States the increase of the call for paper on account of the Presidential election seems already to be preparing to beat the record. In Canada the rapid advance of every branch of trade and industry is bringing about a similar condition on even a larger and probably a more permanent scale.

The more important city newspapers, in spite of the high price of their raw material, news print, have increased their number of pages very considerably

during the last year or two, while the establishment of so many new communities in the West, each with its own journal, during a year or so after its projection from the prairie, is another factor. All these causes conspire to bring up such a heavy demand for paper that the multiplication of new mills seems to have but slight effect.

While largely increasing exports of paper to the United States will probably prove to be the most outstanding feature of the Canadian trade when the new mills to be completed this year make their showing, that market by no means exhausts the possibilities. A significant fact during the past two months has been the enquiry for Canadian newsprint from Great Britain, although this may be said to be due to the exigencies created by the great coal strike. As is shown by remarks in recent issues, there are important openings in the West Indies, Australia, New Zealand, South Africa, the Argentine Republic and else-

where. The United States, with its rapidly increasing consumption, will doubtless require larger and larger quantities of paper from this country. But the point is that, even should that market be loaded up, almost unbounded opportunities exist in other parts of the world if they be only properly developed.



### CHAIRMAN MABEE.

---

It is not often that the press has to record the death of a man who was so liked, admired and honored by all sections of the community, both on the side of the corporations and the masses as Judge J. P. Mabee, Chairman of the Dominion Board of Railway Commissioners. Probably this universal respect and affection were due not so much to his admittedly great knowledge of the law as to the fact that, through his marvellous grasp of inside principles, together with a keen sense of fairness, he could effect that rare combination, make law synonymous with justice. No complainant was too obscure to obtain redress at his hands, whatever might be the size or importance of the corporation whose methods were complained of. On the other hand, what is almost rarer still, the rights and interests of the railroads were never lost sight of in a demagogic desire to obtain the applause of the multitude.

In other words, Mr. Mabee's death is a national calamity at this stage of Canada's growth which cannot be exaggerated. We will not say his place is unfillable; yet it looks almost as if that were the case. To a keen insight and knowledge of the workings of the

human mind, in both a private and corporate capacity, he added an energy and industry in the carrying out of an almost superhuman task which it is doubtful can be duplicated. Yet that is what Premier Borden is called upon to do. We believe he will do his honest best to find a fitting successor. Nevertheless, it is so imperatively important at the present stage of railroad and corporate influence in Canada that the Government should be on guard against their insidious suggestions that we cannot refrain from the hope that the record of any man whose name is considered in connection with the chairmanship of the Commission should be looked at from every point of view—and apart from politics—and then that it should be searched again.



### RECIPROCITY WITH WEST INDIES AND AUSTRALIA.

---

The paper trade should reap some more or less substantial benefit from successful reciprocity negotiations which the Dominion Government has been carrying on for some time past with the West Indies and with Australia. In the case of the former, a trade agreement between certain of the West Indian islands and Canada, affecting the freer interchange of a large number of products, has already been signed by the Dominion Government and representatives of the various islands. Details will not be made public until final ratification by all the legislatures concerned, but it is understood that it is based on a generous preference for the products of each country in the markets of the other. The agreement is between

Canada and the colonies affected, leaving to both the liberty to make tariffs with other countries. Provision is made for including Jamaica, Bermuda, British Honduras and the Bahamas, should they express their willingness.

It is hinted that this agreement, which has been formulated largely through the efforts of Hon. Geo. E. Foster, Minister of Trade and Commerce, will follow more or less closely the lines of that suggested by the Royal Commission under Lord Balfour of Burleigh a year or two ago. If so, it will be of very great importance to Canadian trade. Paper and all manufacturers of the same, will be subject to a reduction of duty when shipped to the West Indian Islands affected, from Canada.

Several articles produced in the West Indies which, according to the terms of the agreement, are to enjoy a Canadian preference, are at present on the free list, so it will be necessary apparently to make an extensive revision of the Canadian tariff schedule affecting them.

The trade of the West Indian Islands amounts to about \$100,000,000 annually, that with Canada being in the neighborhood of (for 1911) \$10,580,000, of which we exported \$4,113,270 and imported \$6,469,382. The principal imports from the islands are cocoa, coconuts, coffee, fruits, spices, sugar and syrup.

It is recognized that trade without transportation facilities is handicapped from the start, and it is gratifying to note that attention to improvement of shipping and cable facilities is to be given at once.

The Dominion Government is also carrying on negotiations with Australia for reciprocity, or a system of mutual preferences. The intention of Hon. G.

E. Foster, when he makes his proposed visit to the Antipodes, is supposed to be to ask for a reduction of the Australian tariff on several lines of goods, including paper.

The general conditions of trade in the Commonwealth are reported by the Canadian Trade Commissioner at Melbourne to be very satisfactory. The country is prospering, and the prospects are that this will continue. The following table showing the marked development of Australia during the past ten years will indicate the rapidity of her expansion. The figures are in pounds sterling:—

Year.	Imports.	Exports.
1901 . . . . .	£42,434,011	£49,696,172
1902 . . . . .	40,675,910	43,915,087
1903 . . . . .	37,811,471	48,250,112
1904 . . . . .	37,020,842	57,485,915
1905 . . . . .	38,346,731	56,841,035
1906 . . . . .	44,744,912	69,737,763
1907 . . . . .	51,809,033	72,824,247
1908 . . . . .	49,799,273	64,311,058
1909 . . . . .	51,171,896	65,318,836
1910 . . . . .	60,014,351	74,491,150
1911 . . . . .	66,860,303	79,484,226
		Total trade.
1901 . . . . .		£92,130,183
1902 . . . . .		84,591,037
1903 . . . . .		86,061,583
1904 . . . . .		94,506,757
1905 . . . . .		95,187,766
1906 . . . . .		114,482,675
1907 . . . . .		124,633,280
1908 . . . . .		114,110,331
1909 . . . . .		116,490,732
1910 . . . . .		134,505,501
1911 . . . . .		146,344,529

Until the trade figures for each State are analyzed by the office of the Commonwealth Statistician, there is no way

of ascertaining to what extent Canadian manufacturers and exporters benefited by the expansion in Australian imports. It will be some months hence before detailed information respecting Australian importations from Canada (or any other country) will be available. With one or two exceptions, every item of the principal lines of Australian imports in 1911 shows expansion.

It is supposed in Australia that the preference to be given on Canadian paper will amount to thirty-three and one-third per cent. Canada's total exports to Australia in 1911 were \$4,000,000, while her imports were \$500,000. The value of Canadian paper shipped there was \$435,392, and there is undoubtedly a big opening.

Some Reciprocity enthusiasts affect to find food for sarcasm in the fact that the same people who turned down Reciprocity with the United States are nevertheless ready to seek it with the West Indies and Australia. But they miss the point. Reciprocity, or mutual preference, between various parts of the British Empire is an entirely different thing from Reciprocity with our neighbors on the South. The former builds up; the latter destroys.



### DECISION IN FAVORED NATIONS CASE.

Although Canada's interests are only indirectly affected, and the argument between the United States Government and the pulp importers is on a domestic subject, the decision arrived at is of so important and far-reaching a character that we cannot forbear making some comment. The Board of General Appraisers decided unanimously in favor

of the Government's claim that the free entry of pulp and paper into the United States from Canada, as provided for in Section 2, does not include the countries which have favored-nations treaties with the United States.

Whatever one may think of the decision itself, the chief argument upon which it was based seems a peculiar one. We already in last issue gave an idea of what this argument was, but would repeat it in the words of the majority report presented by the Board:—

"The words 'country, nation or state' are used to represent an organized body politic, and mean the same thing as country, which embraces all the possessions of a foreign state, however widely separated, which are subject to the same supreme executive and legislative control. Hence Canada is not a country, but only a part of the country of Great Britain."

Another point on which the Government's contention turned seems more reasonable, and was to the effect that any arrangement affecting the revenue of the United States cannot be completed without the consent of Congress, and, as this body has passed no Act specifically giving the foreign countries named such privileges, they cannot be deemed capable of taking advantage of the same.

We have already also referred to the argument of the importers. That of the manufacturers against the free entry of pulp and paper from Sweden was presented by ex-Senator J. C. Spooner. He pointed out that Section 2 of the Reciprocity Act not only constitutes a gratuitous grant of commercial favor to Canada, but that the Act admits the products mentioned upon the condition precedent that no export duty shall



have been imposed upon such paper, board or wood pulp, or the wood used in the manufacture of such paper, board, etc. The power remains with the Dominion of Canada, or the respective provinces, he stated, to impose an export duty upon fee land pulpwood, and also upon pulpwood taken from the provincial public lands, in which event Section 2 would cease to be operative. It, therefore, is a consideration to prevent the imposition of restrictions upon the exportation to the United States of fee-land pulpwood, and it is also a continuing offer of consideration or inducement (and so intended to be) to the provinces to remove the restrictions which they have placed upon the importation of pulpwood cut from the provincial public lands.

"It is not to be denied," Mr. Spooner pointed out, "that we have made heavy drafts upon our forests of pulpwood, and that it is in the highest degree important the the vast and measurably untouched supply of Canadian pulpwoods shall become available to American manufacturers of paper. The accomplishment of this was a substantial motive for the negotiation of the proposed reciprocity agreement with the Dominion of Canada. Not one of the nations under the 'favored nation' clause of whose treaty free entry of the articles covered by the protests is sought can by any possibility pay or make to the United States in any substantial degree the same compensation which is paid or made by Canada under the provisions of the Act."

The importers have appealed the case to the Customs Court. Meantime, the United States Government evidently fears that the foreign countries affected may attempt commercial reprisals of some kind.

## NO POLITICS IN RECIPROCITY?

Remembering how the opponents of Reciprocity were laughed at last September for their "childish fears" of what would happen under closer trade connections with the United States, let us glance at the correspondence which passed on the subject between President Taft and ex-President Roosevelt. It is a case of when politicians fall out, honest men get the truth, for it is only now the letters have been published, although written a few days before the famous agreement was signed.

### Extract from President Taft's Letter.

"It (Reciprocity) might at first have a tendency to reduce the cost of food products somewhat; it would certainly make the reservoir much greater and prevent fluctuations. Meantime, the amount of Canadian products we would take would produce a current of business between Western Canada and the United States that would make CANADA ONLY AN ADJUNCT OF THE UNITED STATES. IT WOULD TRANSFER ALL THEIR IMPORTANT BUSINESS TO CHICAGO AND NEW YORK, WITH THEIR BANK CREDITS AND EVERYTHING ELSE, AND IT WOULD INCREASE GREATLY THE DEMAND OF CANADA FOR OUR MANUFACTURES. I see this is an argument against Reciprocity made in Canada, and I think it is a good one."

### Col. Roosevelt's Reply.

"It seems to me that what you propose to do with Canada is admirable from every standpoint. I firmly believe in free trade with Canada for BOTH ECONOMIC AND POLITICAL REASONS."

Nothing but a purely economic policy to reduce the cost of living in both countries!!! Of course!!!

## NEWFOUNDLAND PULP AND PAPER COMPANIES.

The budget speech of the Newfoundland Minister of Finance contained the following figures relating to the development of the pulp and paper industry of the Island:—

In 1909 no paper or pulp was produced in Newfoundland. In year ended June 30th, 1910, 7,866 tons of paper, valued at \$352,155, and 6,853 tons of pulp, valued at \$69,164, were produced. In following year output was 21,064 tons of paper, valued at \$943,699, and 27,177 tons of pulp, valued at \$251,048. In the six months ended December 31st, 1911, 17,184 tons of paper, valued at \$769,920, and 31,933 tons of pulp, valued at \$360,218, were produced.

Output of pulp and paper this year in Newfoundland will be double that of last year, and next year it will doubtless be doubled again. The Harmsworth mills at Grand Falls, owned by Lord Northcliff, employ 2,000 men, and the payroll this year will amount to \$1,000,000, while the mills are expected to have an annual output, when the new machines are installed, of about 40,000 tons of wood pulp and 60,000 tons of paper.

The Sebert Reed mills at Bishop Falls employ 800 men, and another large pulp mill is being built at Bay of Islands.



## POST'S PAPER AND MILL DIRECTORY.

Post's well-known Paper Mill Directory for 1912 is as complete as ever, containing nearly 700 pages in a strong cover. It comprises lists of the paper, pulp and chemical fibre mills in operation in the United States and Canada, together with lists of mills in operation or projected, classified according to the goods made. A Buyers' Guide to First Hands, giving names of manufacturers of machinery appliances and dealers in paper makers' supplies, is another feature. Jobbing houses in the United

States that carry stocks are also listed. Other useful features are names of rag and paper stock dealers, general paper dealers, paper box manufacturers, manufacturers of paper bags and envelopes, glazed and coated papers, cardboard, etc. Water-marks and brands, trade statistics, etc., help fill out a very valuable volume. The price of this directory is \$2, and it is published by L. D. Post, Tribune Building, New York.



## PAPER FROM FLAX.

The manufacture of linens and paper from flax fibre on an extensive scale in the prairie provinces, where flax is grown extensively, and where hundreds of thousands of tons of flax straw are now thrown away each year, has been, it is said, rendered possible by a new process of handling flax fibre. The incorporation of the Canadian Flax Fibre Co., Limited, of Toronto, last week with a capital of \$3,000,000 marks a first step towards the exploitation of what promises to be a most important manufacturing industry in the West. Paper manufacturers declare that the cultivation of flax in the prairie provinces for its fibre value alone, irrespective of the value of the seed, is destined to become immensely profitable.

By the new process the fibre can be prepared for manufacture in twenty-four hours, whereas under the old process, which has been in vogue since the time of the Pharaohs, over twenty days have been required. Experts consider that there is a great field for industrial development in the manufacture of paper and cloth or linen fabric from the new unused flax straw in the West.



It is understood that the new paper mill at Westminster, B.C., will start up this month. It will make building and wrapping papers, getting its supplies of stock from old papers from the cities of British Columbia and adjoining states. It has one machine trimming to 80 inches.

## A Scottish Paper Maker's Impressions of Canadian and United States Mills.

By ALEX ANNANDALE.

The first thing to make a deep impression on the writer's mind during a visit to Canadian and American paper mills was the extremely kind way in which he was received, and the trouble managers and every one concerned took to explain the conditions under which they worked, and to show their methods to one who was in most cases quite a stranger. This was a very marked feature throughout the trip, and one which some British firms would do well to imitate.

Another noteworthy feature was the magnificent water-powers, and the scientific way in which they have been harnessed. We read about them, but do not grasp their magnitude till they, and the work they are made to do, are actually seen. In the limited time at the writer's disposal he only saw a few (and those not the largest), but still quite enough to enable him to realize their inestimable value to the country that owns them.

With regard to the actual working of the mills, there is no doubt that the paper machines are made to turn out more paper (especially as regards the finer qualities) than those in Great Britain. But the writer could not help thinking that with a little more time given to the beating of the material, the resulting paper would be improved without necessitating any serious reduction in the output; or to put it in another way, a slightly cheaper grade of material could be used to obtain the same results as at present.

The system of calendering the paper is also different from that used generally in Great Britain, where, as a general rule, the rolls are much wider. But, as high and even surface is apparently more wanted by American and Canadian consumers, there is no doubt that the narrower rolls are best. The writer

was, however, surprised to find that water finishing on machine calenders was not more generally used. If it were, it would in many cases save putting paper twice, or even thrice, through the calendar stocks. In Great Britain the water-finished papers (more particularly in the better grades of book papers) have to a large extent supplanted super-calendered papers. When paper is super-calendered, it is almost invariably damped with some water-spraying arrangement, re-reeled, and allowed to be some time before being run through the super-calender, which usually takes the full width of web made on the paper machine.

The cutting, sorting and finishing departments were also a source of much interest to the writer. In Great Britain much more labor is used in these departments, especially in the sorting. Except for cutting water-marked papers to register, single-sheet cutters are rarely used; in fact, most revolving cutters are now arranged to cut water-marked papers to register to the extent of two or three rolls at a time. These cutters cut five or six rolls at a time of ordinary plain papers. All British cutters take the edging or shaving off, so that machine tenders are relieved of that work.

The system of drying fine writing papers in lofts was also of great interest to the writer, who, without seeing it done, would not have believed it possible to "loft-dry" such large quantities of paper. The skeleton drum and hot-air drying machine are almost invariably used by British makers for this class of paper, few mills using lofts except those making genuine hand-made paper.

From what the writer saw and heard, the great trouble in America is the scarcity of labor. Wages appear to run

quite double British average rates, but still help is hard to obtain and keep. This is probably the only important point where the British mill owners have a distinct advantage. They can always at once obtain trained men of experience for any vacancy.

Without doubt there is no want of push and vigor in both Canadian and American paper-making. Apparently Canada is extending most rapidly at present, and from all the writer saw and heard he could not but realize that the prospects there are most promising. During his trip the writer repeatedly saw good cause to regret that he did not cross the sea and remain twenty years ago. However, he hopes soon to be able to do so, and make use of old knowledge and gain new for the advancement of the "trade."



#### SILK FROM WOOD PULP.

In the manufacture of artificial silk in the United States wood pulp from Norway is utilized, being shipped in bales. The pulp is cut into thin sheets, each individual sheet is carefully weighed, and a certain quantity placed in a metal tank for chemical treatment.

The various chemical solutions used are mixed in huge iron tanks, from which they are pumped underground through a series of lead pipes to the departments requiring the various compounds. This pulp having been macerated and digested, is submitted to still further chemical action under certain fixed temperatures, which are not allowed to vary even one-half of a degree.

When it is ready for final transformation into silk the solution closely resembles molasses in color and consistency. At this stage it is pumped from the tanks to the spinning frames. Here specially constructed pumps are attached to each spindle, which carefully measures out the required quantity of the solution.

This is forced through tubes, with an outlet containing just as many perforations as there are to be filaments in the thread. Through these it is passed to a tank running the length of the frame, and containing a chemical mixture which fixes the solution instantaneously into a thread.

This strand is carried over a wheel down through a tube to a rapidly revolving spindle; the rate of speed is about 5,000 revolutions a minute. From this the strands are afterward unwound on reels into skeins. The air in the spinning-room is completely changed every three minutes, being pumped off through hoods placed over each of the spinning frames. This is done to remove any possible fumes and to provide thorough ventilation for the operatives.

One of the interesting features in connection with the entire operation is the fact that the yarn is handled as little as possible. The specially constructed stoves and bleaching arrangements are ideal, and when the skeins are finally carried to the large drying-room on the fifth floor one marvels at the change which has so rapidly taken place. From here they are taken to the sorting-room.



—Alex. Annandale, late manager of the Chirnside Bridge Paper Mills of Scotland, has been visiting the principal paper manufacturing centres of the United States and Canada. Mr. Annandale is a paper maker of wide experience, and has been called to Italy to give expert advice to some paper manufacturers regarding the introduction of the esparto pulp and paper industry in that country. He has made some interesting suggestions for connecting that industry with a fresh development of paper making in Canada, and we hope to treat of this in our next issue. An article by Mr. Annandale, giving his impressions of the Canadian and United States paper industry appears in this issue.



## PULP WOOD REGULATIONS IN BRITISH COLUMBIA.

The British Columbia Legislature recently passed an Act providing that all timber sold must first be surveyed and cruised, and that it shall be put up at public auction at an upset price, which will include cost of same, and will also include an annual rental of five cents an acre and a stumpage duty of 25 cents a cord, the timber to be sold to the highest bidder. The Minister of Crown Lands may decide whether the competition will be based upon bids per square mile or per cord.

When the Crown timber, the license to cut and remove which is proposed to be sold, are chiefly valuable for the manufacture of wood pulp, the license shall be described as a "pulp license," and every person or company tendering will be required to produce proof that they have expended not less than \$350,000 upon the erection of a mill for the manufacture of wood pulp and paper, said mill not being appurtenant to any existing pulp leasehold; or to give a bond of fifty thousand dollars and such other guarantee as the Minister may think fit for the expenditure of not less than this amount upon the erection and completion within three years of a mill, not less than one hundred thousand dollars of such amount to be expended during each of the first two years of the license; and that pulp licenses issued to or held by any person or company shall be appurtenant to the pulp mill in respect to which they were issued, and the total area held under such licenses in respect to any mill shall be governed and limited by the output capacity of such mill, and shall not comprise at any one time more than thirty years' supply of pulpwood for said mill.

To any holder of a pulp license who has erected and completed a pulp mill in the manner prescribed by this section of this Act, and who has operated said mill to full capacity to the satisfaction of the Minister, the upset price as

provided by this Act shall be varied in respect to rental, so that half only of the rental otherwise payable under license shall be due and paid.

The intention of the Act is to prevent sale for speculative purposes. It provides further as follows:—

Upon timber suitable for the manufacture of pulpwood or paper cut as aforesaid (except in so far as may otherwise be provided in any existing pulp lease), a royalty of twenty-five cents per cord, or, when the Minister may so decide, an equivalent royalty per ton of pulp or paper;

Provided that a number of feet, board measure, to be established by Order-in-Council, shall be taken as equal to a cord of pulpwood; and that until such order be issued seven hundred feet, board measure, shall be so taken; but in any case in which he may deem it desirable the Minister may require pulpwood logs to be measured by the cubic foot, or alternatively may require the scale of such logs to be computed on the mean diameter or diameter at the middle of each log, one thousand feet, board measure, of such scale being taken as the equivalent of a cord;

Provided also that a weight of ground wood-pulp and a weight of chemical pulp, to be established by Order-in-Council, shall be taken as equivalent to a cord of pulpwood, and that until such Order-in-Council be issued one short ton of air-dry ground wood-pulp or half that quantity of air-dry chemical pulp shall be so taken.

Upon all other wood or bark cut as aforesaid a royalty of twenty-five cents per cord;

Provided that all timber left uncut, or cut and not removed, in any logging operations upon any such land, which timber, according to the regulations of the Department, should have been cut removed, shall be subject to royalty payable upon demand, to the Department.



The mills already established will have advantage over those which may be established hereafter as regards price paid for raw material. Pulp leases at present running in British Columbia require the payment of two cents per cord rental and 25 cents per cord stumpage, which is less than one-half of what will have to be paid hereafter.



#### NEWFOUNDLAND NOTES.

(Special to Pulp and Paper Magazine.)

April 25, 1912.

The Newfoundland Government during the recent session of parliament passed a bill having for its object the erection of a large pulp and paper mill on the banks of the Humber, in the vicinity of Deer Lake, similar in capacity, etc., to the one now in operation at Bishop Falls and owned by the Albert Reed Co., of London, England. The bill authorizes the raising of the water of Grand Lake ten feet and that of Deer Lake fifteen feet above low water mark. The American-Newfoundland Pulp and Timber Company, comprised at present of H. C. Dykehouse, of Grand Rapids, Michigan; R. G. Williams, Buffalo, N.Y.; W. C. Grobhiser, of Holland, Mich.; and B. C. Crittsinger, of Niagara Falls, N.Y., is the company seeking the rights. This company own 600 square miles of timber lands along the shores of Deer Lake. The lakes are to be dammed for the purpose of generating sufficient power for the operation of the proposed pulp and paper mill. The bill provides that the company shall put up as security \$250,000 before the 1st day of next October, and that actual construction work will commence not later than the first of May, 1913. Machinery for the original installation of the plant is to be admitted into the country duty free, and the company is given freedom from municipal taxation. About \$350,000 have already been expended by the company in the way of purchase of the 600 square miles of

timber lands and surveys on the same. The sum of \$3,000,000 has been subscribed towards the erection of the proposed mills.

The Premier, when introducing the resolutions for the aforementioned bill, stated that one or two other proposals of a similar character were before the Government for the establishment of pulp and paper mills on the south-west coast and also at Gander Lake.

Surveys have been going on for the past few months on timber limits in the vicinity of Corner Brook, with a view to the establishment of a pulp and paper mill at Bay of Islands. So that there will be two large pulp and paper establishments on the banks of the Humber in the not far distant future. At Corner Brook there is a splendid natural watershed capable of generating not only sufficient power to operate such a mill but also to supply light for all the settlements on the Humber.

The two new paper making machines at Grand Falls have been installed and are now working at full capacity. These machines are turning out paper for the Daily Mail and Daily Mirror of London, England.

The A.D.N. Co.'s steamer Tritona has made another trip from London to Botwood in mid-winter. She has discharged her cargo of supplies and is taking on board a cargo of paper and pulp and will sail within a few days for London.

A large quantity of paper and pulp, the products of the Harmsworth mills at Grand Falls, and the Reed mills at Bishop Falls, has accumulated at the warehouses at the Falls and at Botwood, to be shipped to England, and a large fleet of steamers will take up that service with the opening of navigation in May.



James Wood, of Athabasca Landing, has organized a syndicate to build a pulp mill in that district if they can get the timber land. The mill would be operated by natural gas.

## EXPERIMENTS ON GROUND WOOD AT GOVERNMENT LABORATORY, WAUSAU, WIS.\*

It will be unnecessary for me to go into details regarding the purpose of the Wausau laboratory, or as to the equipment which has been installed to carry out this purpose. Howbeit, suffice it to say that all necessary provisions have been made to study the suitability of woods which are available in large quantities for the manufacture of ground wood pulp.

You undoubtedly know that the cost of production of news print paper, as determined by the tariff board, has advanced directly with the increased cost of wood from which it is manufactured; also that the cost of production of ground wood pulp has similarly increased. Ninety-three per cent. of the increased cost of production of ground wood during the past decade can be directly traced to the increased cost of raw material. With this fact in mind, the necessity of securing woods other than spruce which are suitable for the manufacture of ground wood pulp is evident. It is on this account that equipment and technical help were secured which makes possible the study of this problem in all its details.

The entire plant installed at Wausau was so arranged and the machinery so selected as to provide for a variation of all factors which might have an influence on the quality or quantity of pulp produced from any wood or combination of woods. In the grinding process it is possible to vary the pressure, speed, temperature, and surface of stone to widely differing values, and it is also possible to hold any of these factors constant. The general method used in conducting tests on any species was to hold constant all but one of the vari-

ables, and to secure such data on the power, yield and production as are necessary for complete interpretation of the test. In each case graphic records were made of the surface of the stone, and the power applied to the grinder. The quality of the resultant product was recorded by means of photo-micrographs, and in some cases by conversion into news print paper. There has been secured by conducting a large number of tests, data on spruce, balsam, fir, jack pine, hemlock, tamarack, lodgepole pine, and red fir; the last two species, however, have only been touched upon up to the present time.

Before discussing any of the difficulties or disagreeable features of grinding any of the woods which we hope to substitute for spruce in the mechanical process, it may be well to present a summary of the results which have been obtained, and the relations which have been found to exist when spruce is ground under widely varying conditions. The study on spruce has been made primarily to determine the results of the variation of the most fundamental factors which are encountered in the production of mechanical pulp from this wood, since it is believed that many of these relations will exist in the grinding of other woods.

The variables which have been considered are peripheral speed of grinding, pressure, surface of stone, temperature, diameter of wood, and weight per cubic foot. The results which appear to be influenced by the variation of these factors are horse power to the grinder, horse power consumption per ton of pulp, production in twenty-four hours, yield per cord, and quality of pulp.

In all of these spruce tests a single Lombard stone was used and in each case the wood had seasoned for approxi-

\*Report presented before convention of American Paper and Pulp Association.

mately one year. Tests are contemplated in which stones of different grits, both natural and artificial, and green wood will be used, but these have not yet been started.

As a result of the tests which were conducted the following relations have been found to exist:

#### Power to the Grinder.

The power to the grinder increases directly with the speed and pressure, and inversely with the sharpness of stone. There is also a very slight increase with the temperature. It is possible to estimate very closely the power which is being used upon the grinder, knowing the character of surface which is being used, pressure and speed. This estimate can be secured by means of the equation: Horse power = a constant  $\times$  the pressure per square inch of pocket area  $\times$  the peripheral speed in feet per minute.

The constant here spoken of varies with the pressure, speed, and surface of stone, and has a direct relation to the coefficient of friction of wood on sandstone under these various conditions.

1. It has been found that when the pressure is increased and all other conditions are kept constant the horse power consumption per ton falls off according to a definite law which is dependent to a great degree upon the character of the surface of the stone. For instance, you will note on one of the prints which have been distributed two series of three curves, each representing the relations between pressure per square inch on the grinder cylinder, or per square inch of pocket area, and the horse power consumption per ton of bone dry pulp in twenty-four hours, the two series of curves being obtained at peripheral speeds of 2,445 and 3,145 feet per minute. The points which are shown on these curves have been determined by actual experimentation, while the continuations in either direction were plotted in accordance with the geometrical law determined by the use of the three

experimental points. The curves here shown represent conditions which can be obtained on the surfaces of stone given in the legend. It appears to me unnecessary to comment on these curves further, since they present an accurate idea of the power necessary to grind under the conditions of the tests.

2. It has been found that the variation of speed, the other conditions being kept constant, gives a similar curve; that is, upon increasing the speed the horse power consumption per ton is reduced not in a straight line, but rather in a curve, the amount of reduction in horse power consumption per ton being greater for values between 100 and 150 revolutions than the reduction between 200 and 250 revolutions. A chart showing the variation of power consumption with speed and also that of production with speed has been distributed.

The falling off of power consumption at high speed and pressure is important, in that it can be made the basis of an argument in favor of the use of more power on the grinder.

3. The temperature, diameter of wood, and weight per cubic foot do not materially affect the horse power consumption per ton. It is true that the power to the grinder must necessarily be more under conditions of hot grinding, due to the pulp in the grinder pit. However, there is also an increased production, due to the higher temperature, but both the increase in production and the horse power which must be applied to the grinder are only slightly higher than in the cases of cold grinding.

1. The variation of pressure or speed has a direct effect on the production per day, the production increasing almost in direct proportion with the increase of speed or pressure.

2. The surface of stone has a most marked effect on the rate of production. Sharpness of stone corresponding to depth and breadth of burring causes greater production, but at the same time the quality is sacrificed to this increase.

3. The temperature, diameter and weight per cubic foot affect the rate of production much less than is generally supposed, the last factor undoubtedly causing the greatest variation from normal. The production of pulp per day is greatest when the weight per cubic foot is greatest, all of the other conditions being the same.

The yield per cord of wood is dependent upon the surface of stone, pressure, and weight per cubic foot of wood, bone dry, the latter factor being by far the most important. All of the tests which have been conducted indicate that the yield is almost directly proportional to the bone dry weight per cubic foot of wood, when other conditions are the same.

Increasing the pressure causes a direct increase in the yield of pulp at the same time it causes an increase in the amount of slivers which are obtained. This apparently contradictory statement may be explained by the fact that at low pressure, low yield is due to a greater amount of woody material in the white water.

The quality varies greatly with the surface of stone, less greatly with pressure, and least with speed. The weight per cubic foot, and diameter of wood do not affect it materially, and, so far as can be judged from the pulp, the temperature only affects it slightly.

Up to the present time no method has been devised to study the quality of pulp except that of running it into paper and later testing the paper made. The fibre can readily be examined microscopically, but this, of course, gives no measure of the suitability of the pulp for various grades or kinds of paper. It seems almost impossible to obtain tests or series of tests which can be made upon pulp that will give satisfactory information regarding the felting qualities, the finish that can be obtained, strength of sheet, etc.

All of the tests which have been conducted on spruce at the laboratory were run with the view in mind of running a

portion of the pulp obtained from each test into paper. Later, tests will be made on this paper; tests of strength, color, and finish, and comparison of these various factors of quality will be secured. In this way it will be possible, if all of the paper can be made under exactly the same conditions of machine operation, to secure a relation, for instance, between pressure of grinding and quality, or speed and quality. However, this feature of the work has not yet been entered into. Tests have been outlined which will be conducted with this purpose in view, and these tests will be started within a short time.

Record is made of the general character of the pulp simply by observation and feel of pulp from the lap. Of course, this is only a crude means of getting an idea of the quality of this material.

The work on woods other than spruce has, as I have said, included balsam, hemlock, jack pine, tamarack, lodgepole pine, and red fir. None of these series have been fully completed, since in several cases it will be necessary to determine the factors on production and power consumption, quality, etc., after the woods have been given steaming or boiling treatments. The tests on balsam and tamarack have only been completed in so far as pulp of promising fibre have been secured. No paper tests have been made up to the present time.

There seems to be very little difficulty in obtaining pulp from either jack pine or hemlock which will be suitable for production of news and other cheaper grades of paper. It is certain, however, that these woods require a somewhat more careful handling than spruce, particularly hemlock. There is need of considerable care in the preparation of the surface of the pulp stone in grinding this wood. If the stone is at all sharp, a very soft and short fibred pulp will be obtained, and the yield will be quite low. It is almost impossible to obtain a grade of pulp from hemlock which will operate satisfactorily on a paper machine unless



a fairly dull stone is used, and this means the consumption of from 90 to 100 horse power per ton of pulp in twenty-four hours.

The principal objections to jack pine are the pitch present and the softness of the resultant pulp. Both of these, however, can be remedied to some extent. Either prolonged soaking, treatment with steam, or seasoning will, it is believed, eliminate the pitch, and tests are contemplated which deal with this phase of the manufacture of jack pine pulp. The softness of the pulp may also be influenced by these treatments, but it seems that this is an objection which will require treatment in the beater. The colors of both jack pine and hemlock are at fault, too. The hemlock has a decided reddish tinge, while the jack pine is more inclined to be a brownish shade.

The most successful tests which have been conducted resulted when mixed woods were ground, that is, when hemlock was ground in two pockets, and spruce in one, or jack pine in two pockets and spruce in one. Various other combinations have been used, and by the addition of spruce the quality of pulp is greatly bettered. Commercially, it would seem entirely feasible to grind hemlock in one grinder and spruce in another, and later mix the pulps. In this way, the different woods could be ground under conditions of pressure, speed and surface of stone which are most suitable to the individual woods. Many of you, no doubt, have tried the grinding of hemlock and jack pine, and have, perhaps, been more or less prejudiced against either of these woods on account of color, shortness of fibre, or pitch. The various commercial tests which have been conducted at the mills in the vicinity of Wausau indicate very strongly that it is possible to produce news paper and wrapping papers from either of these woods or mixtures with spruce. There have been distributed for your examination a number of samples of paper made from mixed pulps, and jack pine and

hemlock pulps also. You will note, of course, that the color is not what it might be, but this objection could be partly eliminated by carefully conducted tests in coloring.

The color of these sheets is the result of a single trial, and on that account some allowance should be made for the color which has been obtained. Allowance should also be made for the appearance of these sheets as regards brown shives. The presence of these shives is due entirely to the hemlock sulphite which was used and not to the ground wood.

There was almost no difficulty in running the various samples on the paper machines. They were formed at a speed of 465 feet per minute, and gave no trouble, either on the wire, presses or calenders. The jack pine sheet, Run No. 24, is the only exception to perfect operation. It was necessary to remove the dandy after about an hour's operation, since the pitch present caused the stock to stick to it.

One feature of the jack pine paper which you will undoubtedly note is the fluffing up of the fibre brought about by rubbing the sheet. The fibres stand up and give the sheet a very hairy appearance. It is possible, however, that this can be eliminated by the addition of greater quantity of size.

As I have pointed out, the question of color can be partly solved by experimentation in coloring. However, it is certain that the color can never be brought to the color attained in an ordinary spruce sheet of news paper, and it will probably be necessary to co-operate with the newspapers to determine the possibilities of using for news print purposes paper which is slightly off color. For the cheaper grades of wrapping paper, butcher's manila, white manila, and the like, this factor is not of great importance, and it is possible to obtain a sheet which compares favorably with one of spruce, using hemlock or jack pine, without sacrificing any of the advantages of spruce grinding.



# QUALITIES OF CANADIAN PULP WOODS.

By Judson A. DeCew, Chemical Engineer, Montreal.

The classification of certain species of timber as pulpwood, in contradistinction to other kinds of wood, is but an arbitrary nomenclature based upon the commercial application of these particular woods in the paper trade.

The pulp woods of North America are quite distinct species from those in common use in Europe, and were it not for the more or less free interchange of these products on this continent, these distinctions might eventually develop with us. Since the increased necessity for a more economical use of available woods has forced investigations, resourceful workers have evolved methods for converting practically any kind of wood into good pulp and paper. The problem resolves itself into one of total cost, the cost of wood and the cost of conversion being variables for each species of wood used.

Since the spruce woods have proven to be the best adapted for the manufacture of a good paper at the least cost, these woods have become the standard from which all others are judged, and have become invested with such values as the best raw material always brings. The use of the other woods for making pulp is a matter of trade knowledge rather than public recognition, although the practice of the future in this regard will likely alter the popular viewpoint.

There are a number of woods which from their properties and use may be easily classed as pulp-woods, a goodly portion of these being inhabitants of Eastern Canada, while others are found only in the Far West.

## Eastern Woods.

White Spruce—*Picea canadensis*.  
 Black Spruce—*Picea mariana*.  
 Balsam Fir—*Abies balsamea*.  
 Hemlock—*Tsuga canadensis*.

Jack Pine—*Pinus Banksiana*.  
 Poplar—*Populus tremuloides*.  
 Balm of Gilead—*Populus balsamifera*.  
 White Birch—*Betula populifolia*.  
 Canoe Birch—*Betula alba*, var. *papyrifera*.

## Western Woods.

Engelmann (White) Spruce—*Picea Engelmanni*.  
 Sitka (Tideland) Spruce—*Picea sitchensis*.  
 Western Hemlock—*Tsuga heterophylla*.  
 White (Balsam) Fir—*Abies concolor*.  
 Lowland (White) Fir—*Abies grandis*.  
 Amabilis (Red) Fir—*Abies amabilis*.  
 Bull Pine—*Pinus ponderosa*.

In studying these woods in their relationship to paper making, let us first consider those properties which make the spruce wood so suitable for this purpose.

## Eastern Conifers.

The white spruce, *Picea canadensis*, which is the most important tree north of the 60th degree of latitude, is somewhat larger in size than its near relative, the black spruce. Its wood is light, soft, straight-grained and satiny. The bands of summer cells are thin and the resin passages few. The color of the heart and sap is hardly distinguishable. The resin content may vary from 0.2 to 0.4 per cent. The specific gravity is 0.4051 and ash 0.32. In this wood the structure of the spring and summer growth is more uniform than in most of the coniferous woods, the fibres are long and regular, and therefore it is found to grind easily, giving a pulp of light yellow color and a fibre that readily forms in a sheet of paper.

The black spruce, *Picea mariana*, generally occurs with the white spruce, and its wood is very similar in character

and structure, although the summer cells are more resinous and there are fewer medullary rays. The color of the wood is from red to white, the specific gravity is 0.4584, the ash 0.27, and the resin from 0.3 to 0.5 per cent. It is noticeable that the black spruce is heavier than the white spruce, and the yield of pulp from it is therefore proportionately larger.

The Balsam Fir, *Abies balsamea*, is found with the spruces above described and is used in greater or less quantities, mixed with the spruce pulp wood of commerce. The only noticeable difference in its character from the above, is the fact that it is lighter in weight, slightly more coarse-grained and a little more resinous. Specific gravity 0.3819, ash 0.45. When ground a somewhat smaller yield is obtained, and the pulp is a little rougher in its character.

Hemlock, *Tsuga canadensis*. This wood is found in greatest abundance in Canada, although it occurs also in Michigan, Wisconsin and in the Alleghany mountains. Its wood is soft, not strong, brittle, coarse and non-resinous. It shows broad summer bands, and the color varies from light brown to white. Its specific gravity is 0.4239 and ash 0.46. The resin content is very low, being about 0.2 per cent. Chiefly owing to its color and large summer bands, it is much less suitable for ground wood than spruce or balsam, but, owing to its non-resinous character, it is quite suitable for the production of sulphite fibre. The hemlock fibre is larger and coarser than the spruce, and, since the wood is more lignified there is a lower percentage yield of cellulose.

Jack Pine, *Pinus Banksiana*. This is a species of conifer which should be of importance in pulpmaking, for there are very large quantities growing in some districts, and the tree is really too small to be of much importance for lumber. This wood, which is locally called Jack Pine, presents some important technical difficulties in its use, but it will no doubt in the near future be generally

utilized. The wood is light, soft and rather close-grained. The medullary rays are numerous, and these are generally very much in evidence in any low-grade sulphite made from this wood. In comparison with other pulp woods, this wood is very resinous, the resin content probably averaging about 2 per cent. The heart is light brown in color and the sap white. Specific gravity 0.4761, ash 0.23. This wood is now being used to some extent for railway sleepers and pulp, there being no unsurmountable objections to its use in pulp making, when proper working processes are employed. The fibre of the jack pine resembles the hemlock in structure, but the wood is of softer nature, although heavier in weight. Amongst pulp woods, therefore, these two woods, with some others of similar character, might easily be placed in a class by themselves, a second grade.

#### Hardwoods Used for Pulp.

Amongst the broad-leaved trees we have the poplar and white birch, which are destined to take a place of considerable importance in the manufacture of pulp.

Poplar, or aspen, *Populus tremuloides*. This is the most widely distributed North American tree, and it occurs in almost any place where virgin timber is being replaced by a younger growth. It is a small tree, barely large enough for lumber, and its wood is light, soft, close-grained and compact. The color of the heart is a light brown, but it has a thick sapwood which is nearly white. The wood is also non-resinous and its specific gravity is 0.4032, while its ash is 0.55.

Balm of Gilead, *Populus balsamifera*. This is an allied species to the poplar, common along the shore of northern rivers. It is a large tree, but the fibre and the characteristics of the wood are quite similar to that of the poplar. The fibre in both of these woods is short, being about one-half the length of the spruce and this is the factor which re-

gulates largely the use of these pulp woods. The balm, however, is a lighter wood than the poplar, since it has a specific gravity of 0.3636; its ash being 0.66.

Of the birch family there are two closely allied species, each of which is quite suitable for making pulp.

The White Birch, *Betula populifolia*. This is a short-lived tree of rapid growth, which sometimes reaches a diameter of two feet. It grows with the poplar on abandoned or burned lands. The wood is soft, light, close-grained and not durable. The color of its heart is light brown and the sap nearly white, the young trees having the larger percentage of sap, being the best adapted for pulp. The specific gravity of this wood is 0.5760 and the ash 0.29 per cent.

The Paper Birch, *Betula papyrifera*. This is a very widely distributed tree throughout the whole of Canada. It is very common in the northern Atlantic region, and grows farther north than any other deciduous tree. The wood is light, hard, non-resinous and close-grained. The heart has a brownish tinge, but the sap is white. Specific gravity, 0.5955, ash 0.25 per cent.

The fibre of the birch woods is but slightly longer than the poplar, and they can be used to good advantage along with it or replacing it. Being about 40 to 50 per cent. heavier than poplar, however, they are more difficult to bring from the forest, as they are very heavy while green and do not float well. The evident advantage in yield per cord, however, is one that should fully compensate for the extra cost of driving these woods.

#### Western Conifers.

Engelmann, or White Spruce, *Picea Engelmanni*. This wood is found chiefly in the central Rocky Mountain region and the Peace River plateau. In this locality it forms extensive forests, at altitudes of over 5,000 feet, and grows to be a large tree, except at extreme heights. The wood is soft, satiny, and

with a close, straight grain. Like the eastern white spruce, the summer bands are not conspicuous and the heart wood can hardly be distinguished from the sap. The wood is lighter in weight, however, than the eastern variety, for its specific gravity is but 0.3449, and its yield of pulp will therefore be from 15 to 20 per cent. lower. The ash is 0.32.

Sitka, or tideland, Spruce, *Picea sitchensis*. This tree is found in British Columbia, within 50 miles of the coast, and grows to a large size, sometimes ten feet in diameter. The wood is soft, with a close, straight grain, the heart being of a light brown color and the sap nearly white. The wood is almost as heavy as the eastern black spruce, its gravity being 0.4287. The ash is 0.17. The fibre of this tideland spruce is very long and strong, being about 30 per cent. longer than the eastern spruce. The maximum length would be about 6.7 mm. as against 5 mm. in the eastern species. The cellulose made from this wood should be very desirable for the manufacture of strong papers providing it is not weakened in the process of conversion.

Western Hemlock, *Tsuga heterophylla*. This wood is found in British Columbia and the Pacific States, growing along with other large trees of the country. It is somewhat heavier, harder and darker than the spruce, but it is superior in many ways to the Eastern Hemlock. This wood can be satisfactorily ground, but owing to the blackness occurring in some trees, its average color would be a disadvantage. It is non-resinous in character, however, and well adapted for the manufacture of sulphite fibre.

White, or Balsam, Fir, *Abies concolor*. This is used with the spruce for sulphite and ground wood, but, like the eastern woods, the balsam is the more resinous. Its wood is soft, coarse-grained, and compact. The summer bands are narrow and the color is from light brown to white. The gravity is 0.3638 and the ash 0.85 per cent. The fibre is almost as long as the tideland spruce.

Lowland, or White, Fir, *Abies grandis*. This is a large tree found all along the Pacific slope. It is hardly suitable for ground wood except in young trees, and then the resin content is a disadvantage. Owing to the broader summer bands, it is harder than the other woods described, but it has a long strong fibre, and will make excellent cellulose by any alkaline process.

Amabilis, or Red, Fir, *Abies amabilis*. This is another species of fir, which is found in the valleys of the Fraser and Columbia, and on the mountain sides. In the valleys it is a fairly large tree, but on the hillsides it exists very largely as a scrub, with a very close-ringed growth. This scrub growth is very little use for anything except pulp, for a tree from 50 to 60 years old would have a diameter of about 6 inches. It contains about 1 per cent. of resin, which is about the same as the species of black spruce, which also grows as scrub in these mountain regions. The specific gravity is 0.4228 and ash 0.23. The color is not too dark for ground wood, and some day it will probably be used for that purpose, although it is rather too resinous for present requirements.

In the interior of British Columbia, there is another species of pine called the Bull Pine, *Pinus ponderosa*, which is a wood quite variable in character. This wood is supposed to be very resinous, but an average sample examined by the writer, was found to contain but 0.67 per cent. of resin, which is quite within the workable limit. As scrub this is a faster-growing wood than the spruce, and it is somewhat surprising that it should be heavier in weight. The specific gravity of this wood will average 0.4715, and the ash 0.35.

To those interested in the study of woods from either their scientific or commercial aspect, it is a well-recognized fact, that any species having a wide distribution, will, when growing under different influences of climate, soil, altitude, etc., show a considerable vari-

ation in its structure and physical characters. Any fixed data, therefore, although it may represent the species of a number of observations, can only be taken as a basis from which other specimens may be judged.

In the above descriptions it has been the writer's endeavor to show from the properties of the various woods, those attributes which are essential in any wood for the present requirements of pulp making.

The conditions of growth in a northern country seem to be best adapted for the development of those species which have a soft and non-resinous wood. Naturally these woods will be exploited and used in the production of pulp and paper, until the costs of working from this source are such as to allow the profitable working of the cheaper but more resistant woods.



#### QUEBEC LIMIT HOLDERS' ANNUAL MEETING.

The ninth annual meeting of the Province of Quebec Limit Holders' Association was held in Quebec city last month. Among those present or represented were: Alex. MacLaren, president; Geo. Chahoon, jr., vice-president; Wm. Power, Beauce Pulp and Lumber Co.; F. Anderson, River Ouelle Pulp and Lumber Company; Price Bros. & Co., Jonquiere Pulp Co., Wayagamack Pulp and Paper Co., Union Bag and Paper Co., Laurentide Paper Co., Quebec, and St. Maurice Industrial Co., Battle Island Pulp and Paper Co., Lake Megantic Pulp Co., J. M. Dubuc, Rioridon Paper Co., J. Small. The election of officers resulted as follows: Wm. Power, M.P., president; F. M. Anderson and J. A. Rousseau, vice-presidents. Executive Committee—D. C. Atkinson, Arch. Fraser, G. M. Stearns, Wm. Price, H. C. Foy, J. B. White, W. G. Power, H. A. Calvin, D. P. Brown, B. A. Scott; secretary-treasurer, Paul G. Owen; auditor, P. B. Murphy.



## REPORT OF COMMITTEE ON PAPER.

The Committee of Paper of the American Newspaper Publishers' Association, have issued a report, part of which is as follows:

During 1911, as a result of helpful legislation, 54,000 tons of news print paper and 560,000 tons of pulp were imported to offset the restrictive methods of the paper makers and to supply the deficiencies of American wood supply. The Paper Committee helped to broaden the paper market. It inspired proceedings which promise ultimately to bring an ample stock of Canadian Crown land wood to American paper mills. It brought conspicuously into notice the fact that American paper mills of modern equipment could and do make paper more cheaply than mills of any other country. The agitation of paper matters by the Paper Committee promoted many new pulp and paper enterprises. Over 1,000 tons per day of new production of news print paper will probably come upon the market during 1912. Eighty-one companies, aggregating a capitalization of \$83,000,000 were incorporated within seven months, to engage in pulp and paper manufacture in the United States and Canada. Through the efforts of the Paper Committee the mechanical pulp of all countries, when made from unrestricted wood has been put on the free list by Congress. Pulp and paper of all kinds from Canada, costing not more than four cents per pound, were put on the free list by Congress during 1911. It is possible that Sweden, Norway, Germany, Denmark, Great Britain, Belgium and Austria-Hungary, in addition to Canada, may be able to sell paper in the American market free of import duties through the application of the "favored nation" treaties. The matter has been referred to the courts by President Taft.

### Starving the Paper Market.

The output of news print paper in the United States for three years, based on reports of some of the mills to the Bureau of Corporations, has been as follows:

	Tons.
1909 .....	1,023,563
1910 .....	1,112,817
1911 .....	1,204,079

It will be noticed that the average annual increase representing production and consumption has been 90,000 tons per annum, or 300 tons per day per annum. The increase in 1911 was 91,262 tons. In face of this great advance in consumption no new machines have been started by the American paper makers during the year 1911. They were trying to starve the market by reducing the margin between demand and capacity for supply. During 1911 the paper mills which reported to the Bureau of Corporations averaged 3,859 tons per day though the capacity of the mills was 5,038 tons per day, including wallpaper. The paper makers closed the year with a stock of paper on hand sufficient to keep newspapers supplied for less than seven days. At the end of the year 1911 the stock on hand was less than at the beginning of the year. The supply in stock has been steadily declining since August, 1911. At the end of February, 1912, it had dropped to 24,795 tons or less than half the August stock. The exportation of paper for February, 1912, exceeded the importations by 1,500 tons.

At the annual convention of the paper makers, held February 15, 1912, in New York, President Hastings explained to the paper makers how the statistics of their Association purporting to show over-production had been used to deter investment in new paper mills. Prospective investors were told that new machines would enter a market already glutted. The figures furnished at the



annual meeting of the American Paper and Pulp Association show an obvious attempt on the part of the paper makers to restrict production. Such a policy, if successful, would force the consumer to buy the products of antiquated machines which are turning out less than 40 per cent. of the capacity of modern equipment.

The paper makers contrived to offset the importations of 54,483 tons of Canadian news print paper during 1911 by exporting 48,920 tons of domestic paper and thereby avoiding accumulation in the market which would have forced lower prices. They are now scouring South American markets for orders to offset the inevitable increase due to the opening of new mills in June, 1912. Some of this paper they are selling abroad at lower prices than they will sell to the American consumer. They calculate that the consumption normally increases 90,000 tons per annum at the rate of 300 tons per day. All increase in production in excess of 300 tons per day they must offset by exportation or they must curtail the output of each mill correspondingly or they must abandon the present method of starving the market.

#### **The Two-Pound Leeway in Paper Contracts.**

Publishers whose print paper contracts provide a leeway of two pounds upon the standard of 32 pounds for 500 sheets, measuring 24 by 36 inches, should advise the contracting paper maker that the International Paper Company undertakes to furnish paper of a given weight without any given leeway. In other words, it will adhere closely to standard. Competent paper makers agree that the leeway of 6 per cent. either way or two pounds upon a 32-pound standard is an imposition upon the buyer. It is demanded principally by smaller mills, which depend upon petty exactions of that sort to enable them to offset their disadvantages of antique machinery, unfavorable location and inability to furnish any width that may be required.

The larger mills, operating three or more machines, can adjust their runs to any width that may be offered, though a standard width of roll and standard weight, color and surface will tend generally to reduce cost of production and thereby ultimately cheapen the cost to the consumer.



#### **A LARGE PAPER MACHINE.**

The Bury Times describes a new paper machine installed by Charles Walmsley & Co., Limited, paper mill engineers, of Bury, in the Sittingbourne mills of Edward Lloyd, Limited. This machine is in No. 3 Mill, and is the same size as its near neighbor, No. 16 machine, which is also a "Walmsley" machine. These two machines are easily the largest in Great Britain, and probably in the whole world. No. 17 machine makes a web of paper 162 ins. wide, and will make over 40 tons of paper per day, increasing the output of the mills by another 250 tons per week. The machine has on it all the latest improvements and devices ever yet introduced into the manufacture of paper. It is driven without friction clutches or gear wheels, and the builders of this machine are to be congratulated upon the great success which has attended the drives in this direction, as its utility and great efficiency are undoubted. Messrs. Walmsley & Co. are to be congratulated upon this fine record.

The Bury Times adds: This firm have, during recent years rapidly come to the front as makers of paper-machines, and there are probably few larger firms in the world. Messrs. Walmsley & Co. are still engaged in making considerable extensions to their works. They have obtained a lease of a good deal of ground adjoining their present works, and are engaged in extensions which will take some time to complete. In the meanwhile the productive capacity of the present works is being tested to the utmost.

## IMPORTATIONS OF PAPER INTO SOUTH AFRICA.

There are no paper mills in the Johannesburg consular district, comprising the Transvaal, Orange Free State, and Rhodesia, says the Canadian trade agent there. Three English manufacturers of paper have branch houses in Johannesburg, in all of which large stocks of paper of nearly all kinds are carried. Several wholesale houses also import paper in large quantities and carry it in stock.

Practically all of the paper used by the daily and other newspapers of this district is imported from Canada, while the paper for the general printing trade, outside of the newspaper offices, comes mainly from England, the balance being received principally from Germany, Sweden, Belgium and Norway. The great bulk of colored printing paper for poster and cover work is imported from Sweden. Nearly all of the ordinary grades of book paper come from England, while the art papers and others in which superior finish is required are imported mainly from England and Germany.

About one-third of the wrapping paper imported into this consular district is of Swedish manufacture, the countries of exportation next in importance being Germany, England and Norway, in the order named. Wrapping paper is chiefly imported in sheets 29 by 45 inches, folded, and is supplied in all weights. Other sizes in use are 36 by 46 inches, and 14½ by 22½ inches. Wrapping paper in reel form, to be torn off as used, such as is in vogue in the United States, is seldom seen here. It would seem that if properly introduced it might find favor in this community. The kinds of wrapping paper most popular in this market are drab sealing and "kraft." These are shipped in bales, with wood at top and bottom, and are strapped with hoop iron. Wrapping paper is usually ordered in one-ton (2,240 pound) lots.

### Writing and Toilet Paper Largely from England.

Of the imports of commercial paper, such as typewriting, faint-ruled foolscap, foolscap with money columns, letter-size writing, notepaper, blotting, drawing paper, envelopes, and toilet paper, about 80 per cent. comes from the United Kingdom. Note papers, including envelopes, are principally imported from England, Germany, and France, and England now sends most of the typewriting papers. Some time ago a fairly large amount was received from the United States, but owing to keen competition the trade reverted to England.

Nearly all of the carbon paper coming into this district is from the United States, a small supply being brought from England. It is generally conceded that American carbon papers are much superior to others. Ruled commercial papers and letter pads are chiefly purchased from England. There is a large demand for letter-size writing-pads with faint-ruled sheets, 100 to a pad.

Practically all of the commercial envelopes are of English manufacture, although the "outlook" or "window" envelopes made in the United States and Canada are becoming popular with some of the leading business houses.

England supplies nearly all of the blotting paper used here, principally white, a small quantity coming from the United States. The English article comes to a great extent in sheets 22½ by 17½ inches, folded, in quire lots, 38 pounds, the 60-pound paper of the same size being in the flat. American blotting papers are all imported flat. The drawing paper in use here all comes from England, and an enormous quantity is used. All of the imports of blank books are also of English manufacture.

Toilet papers (medicated tissues) come both in reels and flat packets. The

principal importations are from England, although a few firms stock the American article, in rolls. Japan also supplies a small quantity of tissue paper in flat packets.

#### Methods of Packing.

Note papers are packed in cardboard boxes of one-fourth ream each, four of these boxes being packed in a larger paper box making one ream. Envelopes for note paper are packed in cardboard boxes containing 100 each. Typewriter papers are put up in paper boxes of one ream each, while carbon papers are packed 100 sheets in each box. Ruled commercial papers and blotting papers are sold by the quire, and toilet papers in reels are packed in cases of either 100 reels or three gross each, while the toilet papers in the flat are packed in cardboard boxes of six packets each.

In commercial and letter size envelopes, the better quality is packed in boxes of 250, while the cheaper grades are packed in boxes of 500. Large size commercial envelopes are packed 100 in a box.

Paper bags are much used by storekeepers, green grocers and fruiterers, and all are imported, there being no paper bag manufactory in this consular district. The demand is nearly altogether for English made bags on account of their low cost. Some shopkeepers prefer the American made bag, although it is a little higher in price than the English article, for the reason that it is considered stronger and better made than the others.

Strawboards and "leather board" are both classed as cardboard, and are almost entirely imported from Sweden. These are used for the manufacture of cardboard boxes and paper tubes. Crinkled tissue or crêpe paper for lamp shades and other ornamental purposes is imported in all colors in six-foot lengths, all of it coming from Germany.

#### Much Wall Paper Sold.

The sale of wall papers in this consular district is very large, owing to the fact that in the erection of private houses

there are very few white plastered walls. Inasmuch as contractors substitute a cement plaster wall, which is a great deal rougher and not so well finished as the white plastered wall, it is necessary to cover the walls of houses with wall paper before they are let, in order to give the interior a finished appearance. The demand here is for medium-priced and cheap grades of wall paper, very little high-class paper being used.

Over 80 per cent. of the wall paper imports into this consular district are of English manufacture, Germany following with 10 per cent. The American wall paper is generally considered too expensive for the trade here and is imported in very small quantities. The little that is imported comes in rolls 16 yards in length by 21 inches in width, while the English and continental wall papers are in rolls 12 yards in length by 21 inches in width. Frieze comes in rolls 9 yards in length.



#### MORE PNEUMATIC MACHINES.

The Sherbrooke Machinery Company, Limited, Sherbrooke, Que., have completed shipments of a pneumatic save-all system and pneumatic sulphite thickener system to Price Brothers Co., Limited, "Kenogami Paper Mills," Jonquière, Que., both equipments being the "Battery Design Machines" (patented). These pneumatic machines being operated in compact rows by one blower (and by one long line of shaft to each row), have positively standardized the processes of thickening pulp and extracting stock from waste water. Their operation is automatic, and is automatically maintained at the desired rate or density of output. Their delivery is continuous, and the operation of the entire battery is in plain view, unobstructed by top gear or overhead connections.

No other class of make of pulp mill machinery affords the operative or the superintendent such a chance to keep his work up to the standard without waste of time, power or stock.

# MOISTURE TESTING OF SULPHITE PULP.

By T. L. CROSSLEY.

In articles dealing with this important question of mill routine and market relations, commercial practicability has been sacrificed to mathematical accuracy. The pulps with which American chemists have to deal vary so widely in moisture content and form of package, that the study of moisture distribution in one form of package gives no data applicable to other forms.

Breaking bales or rolls and cutting wedges or strips from several parts of the bale is a quite impracticable procedure for routine testing in a large mill from the standpoint of both time and

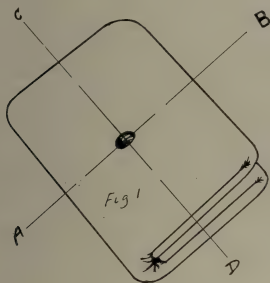

space. It is difficult if not out of the question to hold a carload of pulp pending test.

The sheets vary greatly in thickness and moisture. A thin dry sheet weighs much less per square foot than the thick wet sheet so often alternating with it under mill conditions. With the wide range of moisture content mentioned, accuracy in sampling can only be approached by taking the average of many samples. One bale in ten is insufficient for a 60,000 lb. car of 250 lb. bales, but quite sufficient for a lot of ten cars. The variation in moisture for a car of machine dried sulphite will often be as much as 25%, sometimes

even 30%. It can readily be seen that samples accurately representing twenty-five individual bales in a lot of 250 with a variation of 25% may not be representative of the total content of the car. A more expeditious, even if less accurate, sampling of twice as many bales may come nearer the correct figure for the whole car.

The chemist at a paper mill buying wood pulp, may be called upon as a detail of his routine to determine for several cars in a day, the moisture contents of the kinds of pulp and forms of package described below. Academic methods of sampling are out of the question.

**FIRST. — Machine dried Sulphite Pulp.**—This comes in two forms of package, the bale and the roll. The bale weighs about 250 lbs., the roll from 100 to 150 lbs. A car usually contains from 250 to 300 bales, and about twice as many rolls. Bales are fastened with strings, wires, or bands. Rolls are usually tied round once with string or fastened by a notched fold on the pulp. Bales are prepared by running the output of the machines through a cutter after the continuous web from the machine has been divided longitudinally into three or four strips. The machine dried pulp is thus cut into sheets about 24" x 30" and carried by hand or conveyor to the baling machine. If carried by hand, it will often be found that the knives being dull on the cutter, the pulp has merely been scored and folded instead of being cut. This condition complicates the sampling of such a bale by the strip or wedge method. Any one of the bales in such a state of affairs may contain pulp from several machines, or it may contain "wet broke" surreptitiously added by the machine men, thus adding to the already wide moisture variation and the com-



plex requirements of an accurate moisture test. Rolls are subject to similar treatment. The writer has seen rolls made up by running in with the machine web, a web that owing to a break in the sheet was accumulated under the machine. He has seen tests for moisture made by cutting a strip from one thickness of such a roll, and this test used in making up machine output. This kind of test leads up to the condition in which the shipper finds that he has shipped in a month several tons less than the mill is credited with.

The writer has made several series of moisture tests to see if there is any ap-

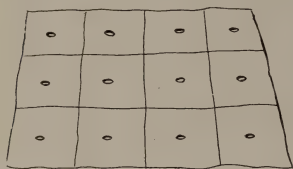

Fig. 2

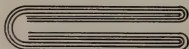

Fig. 3

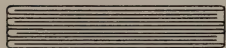

Fig. 4

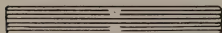

Fig. 5

preciable difference in the moisture test on average car load samples from top, bottom or middle of machine dried pulp in bales as received at the paper mill. Tests of ten cars from which samples were taken at top, middle and bottom of bales and taking one bale in ten from each car, showed an average variation of little more than one-fourth of one per cent. for the three positions:

Top . . . .	76.22%	air dry pulp
Middle . .	76.24	" " "
Bottom . .	76.50	" " "

Efficient sampling of such pulp may be done by cutting out a circular core from the upper side of each bale or roll and cutting to the same depth, re-

jecting two or three of the resulting discs from the outside of the bale.

In the case of baled pulp, i.e., bales of 250 lbs., or thereabouts, not less than one bale in five should be sampled to represent a car unless the lot in question consists of ten or more carloads. In the case of rolls of pulp one roll in ten is sufficient.

**SECOND.—Wet Sulphite Pulp.**—This pulp also appears on the market in several forms. For all-rail handling from pulp mill to paper mill this pulp is shipped in single wet "laps," that is the sheet cut by hand from the roll of the wet machine and folded. The moisture variation in this form is not so great as in the machine dried. It will run about 40% "air dry" pulp. The writer has found that the sampling of this pulp is best done by cutting a core in the centre right through the lap as shown in the diagram (Fig. 1). If the sheet has been folded in three, with ends turned over and doubled in to centre, it will be found on unfolding that the sheet has been sampled in 12 places (Fig. 2).

This can be rapidly done with a proper sampling tool. It precludes sources of error from difference in moisture due to uneven pressure on the machine. It prevents the error arising from a difference in the two sides of a thick sheet due to the fact that one side is pressed against a non-absorbent wooden roll while the other side is pressed against an absorbent felt. This difference may be quite considerable. Thirty laps through a carload have been found to give close duplicate results in a series of carload tests in which sixty laps were sampled throughout each car and alternate samples kept for duplicate test. In sampling this form of pulp, it is necessary to get a reasonable proportion of light and heavy laps.

Another form in which wet sulphite is shipped is in that of hydraulically pressed single laps. These are produced by folding the sheet taken from the wet machine in a similar way to that shown in Fig 1, and then submitting the



folded lap to pressure between felts in a hydraulic press. In this case another condition has to be reckoned with. The sheets being cut and folded by hand, are very seldom folded along the same lines. In some laps a section at A-B Fig. 1 would be represented as Fig. 3 with a section at C-D as in Fig. 4.

In other laps the corresponding sections will have A-B as in Fig. 3, but C-D as in Fig. 5.

These two cases are types and each has variations. When these laps are

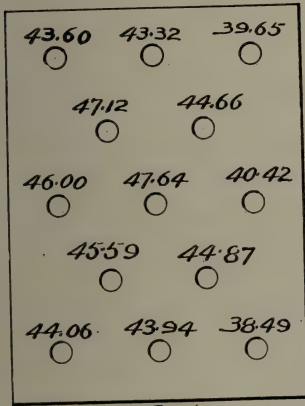

Fig 6.

pressed, the pulp at voids becomes wetter than the average of the rest of the lap. On the contrary, if folding be so that there are more thicknesses of pulp at any point, then that area will be drier.

The procedure in sampling such laps as these must be radically different.

Fig. 6 shows the figures for moisture on one such lap, tested by the writer.

These figures show the "bone dry" pulp at each point sampled. The reason for the low test at the right hand of the lap is, that these points coincide with a void similar to that shown on left of Fig. 3. These laps may be sampled so that close duplicates can be had from a car by cutting one core from each

lap tested and taking each successive core from a different one of the thirteen positions shown in Fig. 6. Five such series or sixty-five laps will give reliable figures for a car load.

The circular core has been adopted by the writer for the following reasons: rapidity of cutting, equal area, possibility of taking equal weights from packages, compactness and portability of samples and ease of weighing.

The form of oven is important and, for saving of time, its location. Two concrete instances in actual practice will show the need for attention to this aspect of the pulp and paper trade. These are not exceptional cases.

The writer was on one occasion called to sample at a mill some hundred miles from his laboratory. On phoning from the city, he was told that the mill had every facility for making moisture tests. Unfortunately, having to leave hurriedly, this was assumed to be the case. A small sheet-iron box was shown by lantern as the oven, on the top of the boilers, up a ladder in a very dark and dirty boiler house and the only available thermometer was obtained after several hours' search from a cheese factory about a mile away. This mill "tested" pulp regularly by weighing one or two strips in a paper scale, and entered claims for excess moisture with the data so obtained.

Another mill whose shipments were continuously found short, made the ingenious statement in the course of correspondence, that they never heated their pulp testing oven higher than 135° F. Of course they would not if they could find customers who would take their billed weight. It made a difference of twenty-nine thousand dollars a year to them if they did with their other customers what they did with one mill, i.e., bring their average shortage down from fifteen hundred pounds per car to an almost exact agreement with purchaser. It is quite impracticable to sample a full car properly without unloading. Receiving mills would therefore have to

provide means of storing car lots pending test, and in such a manner, that goods from each car are kept separate and distinguishable, a simple but often neglected detail. The test lots may be put aside as unloaded and left with the car lot until tested. All this may be avoided as will be shown later. Who is to do the testing? This is an important point. It is manifestly useless to attempt regulation of sale by moisture test without mutual confidence; and, therefore, independent testing is indicated. Here again a point arises. A quite impartial man may take an unfair sample if he is not familiar with conditions in pulp mills. For special cases an outside man may be necessary but it is obvious that for at least two reasons the moisture testing must be done by regular employees. First, to arrive at figures for mill output. Second, because in mills of any size, shipments are made daily, and at the receiving mill cars are received daily. For acceptable figures, integrity and experience are called for in the person of the tester. It is absurd to put any man to testing who is not conversant with mill details and the composition of the various packages.

The system of sampling must be such that similar and equal samples can be taken both at the shipping and receiving mills. The rapid core system provides for this, and also obviates the necessity for completely unloading a car before checking moisture test. The packages, bales, rolls or laps tested at shipping mill not being broken, may be kept out of car until nearly loaded when they can be placed at centre of car between the doors and on top. When the car arrives at receiving mill, the man in charge will be able to sample the same packages and check the test. He will, from time to time, check by taking a second lot throughout car. It is manifestly unfair for the shipping mill to force a stipulation accepting their moisture test with the only alternative of a joint test, because this can in the nature of things only be done on a few cars at

a time. It is largely due to this take-it-or-leave-it-alone attitude that there has been so much trouble over moisture tests.



### TRADING ON REPUTATION.

There are a number of trade expressions that have almost the force of a brand. "Manila paper" has had for many years the reputation of being the strongest sort of wrapping paper available. The papermakers began to trade upon that reputation and upon the insistence of the consumer for paper of that name and they kept lowering the quality of such papers until to-day "manila paper" does not mean paper containing any manila film, but a paper made from sulphite fibre, with sometimes 60 per cent. of ground wood.

At the present time there are far better wrapping papers on the market than any of these so-called manilas. What the buyer of wrapping paper wants is area and strength. By considering these two factors in connection with price and without regard to what the paper may be called, many of the larger consumers of wrapping papers could easily save thousands of dollars a year.

Purchasing from brand-names and not from specifications, is condemned as an extravagant practice in a recent paper by Mr. Arthur D. Little, president of the American Chemical Society. He quotes this instance:

There is a special sort of clay, very much favored by paper-makers. Its popularity has become so great that this clay, which originally came from a particular pit, is now in demand far beyond the capacity of that pit to supply. The result is that the operators buy up clay from a number of pits in the district and put it out under the old brand, whereas clays from these pits without brand could probably be bought for substantially less money.—From paper on "The Abuse of Brand," by Mr. A. D. Little, president of Arthur D. Little, Inc.

## PULP AND PAPER NEWS.

The Rolland Paper Co. may issue bonds in order to obtain additional capital for making extensions to its mills.

\* \* \*

The Miramichi Pulp and Paper Co., Chatham, N.B., has been bought for \$26,000 above mortgage by the Royal Trust Co., Montreal.

\* \* \*

H. Austin, manager for Ernest Scott & Co., Fall River, Mass., the well-known manufacturers of evaporators, was in Toronto last month.

\* \* \*

E. O. Babcock, of Niagara Falls, N.Y., is now carrying on the James Davy mill. He is the son-in-law of the late J. Davy. T. H. Loftus remains as superintendent.

\* \* \*

F. J. Welwood & Co., Limited, a company recently organized to take over the business of F. J. Welwood, will erect a pulp mill and cardboard factory in Elmwood, Man., at a cost of \$125,000.

\* \* \*

The Pigeon River Lumber Co. are asking Port-Arthur, Ont., council to arrange to supply them with 5,000 to 6,000 horse-power at \$12 per annum per horse-power with a view to erecting a pulp mill.

\* \* \*

The Colonial Wood Products, Limited, Thorold, have their output fully provided for for a considerable time to come. In fact, all the pulp manufacturers in that locality may be said to be in the same position.

\* \* \*

The Quebec Government and Laurentide Park authorities have not yet given consent to create storage on the limits of the Bayless Pulp Co., who are to build mills at Beauré. They require storage on the St. Anne, to increase their water-power.

Price Bros. are said to contemplate building another large pulp and paper mill at Chicoutimi as soon as the one under construction at Jonquiere is finished.

\* \* \*

The Hamilton & Ayers Co., Limited, Lachute Mills, Que., are disposing of their pulp machinery, and will not make any more pulp, using their water-power for electrical purposes.

\* \* \*

W. H. Rowley, president and managing director of the E. B. Eddy Co., Hull, has bought Stadacona Hall, Ottawa, a former residence of Sir John A. Macdonald, and a very fine building.

\* \* \*

The Berlin Mills Co. have bought about 22,000 acres of freehold land from B. C. Howard, and are said to be negotiating for 13,000 acres more from the Chaudiere Lumber Co. in Quebec Province.

\* \* \*

The Oyamel Co., of which Col. B. A. Scott, Quebec, is general manager, contemplates building a 400-ton pulp mill on the Grande Discharge, where they have an immense water-power. Their limits at Lake St. John comprise 1,500 square miles.

\* \* \*

The Interlake Tissue Paper Co., Merriton, Ont., has started work on the construction of its plant. The building will be of two stories, 208 by 70 feet, of reinforced concrete, brick and steel and concrete foundations. Machinery has been ordered.

\* \* \*

The Union Bag and Paper Co.'s recently completed addition to the pulp mill at Cap Magdeleine, Que., is now operating. The building is of one story, of brick, with concrete foundations and steel roof trusses. Electric power from Shawinigan Falls is used.

Prof. W. P. Cohoe and Col. J. B. Miller, of Toronto, are behind a project to construct a plant to utilize sawdust and other waste materials from lumber mills. By the process to be employed the sawdust is converted into glucose, and, by the addition of yeast, into alcohol.

\* \* \*

In connection with the project for building a pulp and paper mill at Nepigon, we are informed by Thomas Marks that only the development of the Cameron's Falls water-powers is being proceeded with at present, and it is not known when operations will begin on the construction of the mill. MacKenzie and Mann are behind the enterprise.

\* \* \*

A factory for making wire cloth for paper and pulp mills is to be established in Ottawa at a cost of \$25,000 by J. R. Buchanan, of the Appleton Wire Works, Appleton, Wis., associated with J. W. Perazo and L. M. Peebles. The city of Ottawa has granted a fixed assessment of \$5,000 for ten years on the plant.

\* \* \*

The Lake Superior Corporation recently was granted power to issue \$30,000,000 in bonds to cover present liabilities and provide for additions and extensions amounting, in all, to several million dollars, including the steel rail mill. The bond issue will represent 5 per cent. first mortgage and refunding bonds of the Algoma Steel Corporation, and will be guaranteed as to principal and interest by the Lake Superior Corporation. The Algoma Steel Corporation will be a consolidation of all the Lake Superior Corporation steel-making plants, and the new capital arrangements are to effect permanent financing of these properties. It is proposed to issue only \$13,000,000 of the authorized \$30,000,000 bonds at present. Of this amount \$10,000,000 will be devoted to taking up of two issues of three-year notes now outstanding, and the remainder will be devoted to extensions and improvements.

The Ontario Government will shortly invite tenders for the Abitibi pulp limits as the first step in its development policy for Northern Ontario, for which \$5,000,000 was appropriated at last session. A provision of the lease of the limit will be the construction of a mill at Iroquois Falls.

\* \* \*

The Brompton Pulp and Paper Co. purchased 5,200 acres of woodland in the Weedon district, Quebec, from the George Van Dyke estate. The price is understood to have been \$150,000 cash. This is said to be the best and dearest tract of land ever sold in the Eastern Townships for timber purposes.

\* \* \*

The plant and business of the Kingston Paper Box Co., Kingston, Ont., have been acquired by the British Whig Publishing Co., though the former name will be retained. Some extensions will be made. The company makes paper and cardboard boxes for confectioners, tailors, milliners, dry goods houses, etc.

\* \* \*

The building of J. R. Walker & Co., Montreal, importers of and dealers in rags, paper stock, etc., was last month almost destroyed by fire with a loss of \$25,000. The roof, however, was not burned, so the firm hope to get cleaned up soon and be at work again. The stock will have to be dried or used at once. The loss is covered by insurance.

\* \* \*

The paper mill of Crabtree & Son, located near Joliette, Que., on the shore of Lake Oiseau, on the 7th inst., was totally destroyed by fire, and a watchman named Payette killed. The fire, the origin of which is not known, had secured a good hold on the building before it was noticed. An explosion also occurred, which blew up the floors of the building, and enabled the fire to completely destroy its interior. Payette was caught in the premises, and his escape was cut off by flames and smoke. The damage will amount to \$75,000 or \$100,000, partially covered by insurance.

\* \* \*

The application of the James MacLaren Co., pulp manufacturers, Buckingham, for rights on the Gatineau River, hinging on the question of whether that is a navigable stream, was left undecided by the Supreme Court of Canada and will go before the Privy Council in England.

\* \* \*

The Bayless Pulp and Paper Co., formerly of Austin, Pa., and who have a rossing mill and timber limits at Beaupré, Que., contemplate building a dam on the St. Anne River to develop 5,000 horse-power and obtaining 5,000 horse-power in addition from the Stadacona Hydraulic Co., with the ultimate view of building a 100-ton pulp mill.

\* \* \*

The Consolidated Pulp and Timber Co. was recently formed, with ex-Senator Jones, of Bangor, Me., as president, to take over the business of the Naskwaak Lumber Co., Limited. The promoters also had expectation of acquiring the Edward Partington Pulp and Paper Company's business, but so far the negotiations have not been successful.

\* \* \*

J. R. Booth, Ottawa, is having trouble with some of his men. He made them an offer of an increase of 6½ cents per hour, but they turned this down and demanded a day of three eight-hour shifts. Those who did not accept the latest offer were told to leave, and about forty in the beater-room drew their money and severed their connection with the firm.

\* \* \*

The Ontario Paper Co., which will erect the large pulp and paper mill at Thorold, has awarded a contract for 11,000 horse-power to the Ontario Power Co. Work on the new buildings is to commence at once. There will be twenty grinders and two large newsprint machines. We understand that Warren Curtis, jr., son of the Mr. Curtis who was construction manager for the International Paper Co., will be manager.

The Toronto Paper Manufacturing Company's plant at Cornwall, Ont., was closed down for a while last month to allow of improvements being made at the Cornwall Canal, and the occasion was taken advantage of to overhaul and make improvements to the mill buildings.

\* \* \*

The Ontario Pulp and Paper Co.'s new sulphite plant at Sturgeon Falls, Ont., will be operating within a few days with an output of thirty tons per day. In the news print mill a new electrical equipment is being put in. A. E. Millington has retired from the management of the company and his place taken by Joseph Slater, formerly of the International.

\* \* \*

Another large pulp and paper mill may soon be built in Quebec Province by a strong English syndicate. Mr. R. O. Swezey, C.E., of the firm of Kimball & Swezey, pulp and paper mill engineers, Quebec city, is the forestry engineer commissioned to examine and report upon several tracts of limits and water-powers in different parts of the Province of Quebec, and upon this report will depend the choice of site for the proposed mills.

\* \* \*

The St. Lawrence Paper Co., Mille Roches, Ont., has taken over the Montrose Paper Co., Thorold, and the new concern will be entitled the St. Lawrence Paper Mills, Limited, the capital of which is \$2,000,000. It is believed considerable economies can be effected by the union of the two companies. The president will be I. H. Weldon, of the St. Lawrence; T. A. Weldon, of the Montrose, vice-president, while S. F. Duncan will be secretary, with headquarters probably in Toronto. The Thorold mill will make chiefly ledgers, bonds and writings, and the Mille Roches mill largely book paper. At the Thorold mill a new 140-inch machine is now being put in which will increase its capacity to nearly 25 tons per day.



R. O. Swezey, Forestry Engineer, of Quebec, is going to speak, May 17th, on "Natural Resources of Quebec," dealing chiefly with the pulp and paper possibilities at a banquet in Boston, Mass., of the Society of Chemical Industry and American Chemical Society. Prominent Boston business men will attend.

\* \* \*

In accordance with the judgment in action of Diehl et al vs. Carritt et al in the High Court of Justice, dated the 7th of October and the 16th of November, 1907, and under which judgment E. R. C. Clarkson was appointed receiver of the assets of the Imperial Paper Mills of Canada and the Northern Sulphite Mills of Canada, the creditors of the said receiver are, on or before the sixth day of June, 1912, to send to George Kappelle, K.C., official referee, at his chambers, 54 Victoria Street, Toronto, full particulars of their claims, or they will be excluded from benefit of the said judgment.

\* \* \*

The by-law at Fort Frances, Ont., to fix the flat rate of assessment of the Ontario and Minnesota Power Company at \$25,000 for a period of ten years was carried by an overwhelming majority. President Backus, of the Power Company states that 600 men will at once commence work on the construction of the 120-ton paper and pulp mill and the work rushed to completion. Over \$1,500,000 will be expended, and about 500 men will be employed the year round. The terms of the agreement as ratified by the ratepayers provide one-half the power must be retained always for use on the Canadian side. This now ends the long and drawn-out dispute between Fort Frances and the corporation. The work of erection of the plant will be in charge of T. D. McNulty, formerly of Ottawa, but more recently of St. Paul, Minn., who has superintended construction of some of the largest mills in the States.

## NEW INCORPORATIONS.

Heaps-Brick Co., Limited, Vancouver; capital, \$100,000. To manufacture and deal in pulpwood, pulp and paper.

Nadena Valley Land Co., Limited, Vancouver; capital, \$250,000. To manufacture and deal in paper and pulp.

Denman Supply Co., Limited, Vancouver; capital, \$200,000. To manufacture and deal in pulp and paper, cardboard, etc.

English Bay Lumber Co., Limited, Vancouver; capital, \$30,000. To import, export and prepare timber, pulp and paper.

Riordon Pulp and Paper Co., Limited, Montreal; capital, \$6,000,000. To purchase the business of the Riordon Paper Co., Limited.

J. & A. D. Grimond (Canada), Limited, Toronto; capital, \$50,000. To manufacture and deal in paper and all kinds of merchandise made from paper.

Bilandeau-DuBord, Limited, Montreal; capital, \$50,000. To manufacture and deal in wood and pulp, etc. J. E. Saucier, R. Chenevert and F. Callaghan, all of Montreal.

P. D. McTavish, Limited, Vancouver; capital, \$10,000. To manufacture and deal in wood pulp, paper and articles made therefrom, including cardboard, millboard, etc.

Lake Superior Iron and Steel Co., Limited, has been authorized to change its name to Algoma Corporation, Limited., and to increase its capital from \$1,000,000 to \$30,000,000; also to manufacture pulp and paper.

Gulf of Georgia Coal Mines, Limited, Vancouver; capital, \$60,000. To make and deal in pulp and paper and products made from them, and to carry out the agreement made between G. A. McLeod, H. R. Swayne and Thetis Island Coal Syndicate.

Frontenac Realty Co., Limited, Quebec; capital, \$140,000. To manufacture wood, pulp and paper, exploit pulp and paper factories, etc. E. Roberge, M.P.P., Lambton, Que.; E. de Varennes, M.P.P., of Waterloo, Que.; E. Dubord, M.P.P., of Beauport, Que.

TELEGRAMS } MILNE, EDINBURGH  
CABLEGRAMS }

Code A B C 4th & 5th Editions.

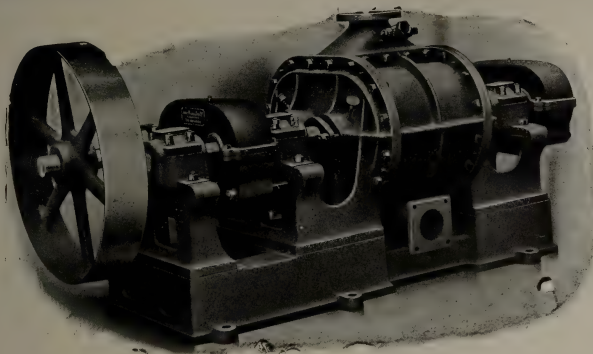

# HIGH DISPLACEMENT VACUUM PUMP

*(Made in Various Sizes)*

Suitable for  
SUCTION ROLLS or VACUUM BOXES

MANUFACTURED BY

## JAMES MILNE & SON, LIMITED

MILTON HOUSE WORKS, EDINBURGH

*DESIGNERS  
AND  
MANUFACTURERS  
OF HIGH CLASS  
PAPER MILL  
MACHINERY*

*FAST RUNNING  
PAPER MILL  
MACHINERY  
A SPECIALTY  
LEAST VIBRATION  
LEAST BREAKAGES*

*Don't Touch Your Mill Equipment Without Trying Milne.*

—Special trains of shareholders and others interested in the Espanola mills leave Montreal and Toronto on the 14th inst. for the purpose of inspecting the new plant.



### TRADE AND MANUFACTURERS' NOTES.

Bertrams, Limited, Sciennes, Edinburgh, have appointed Chambers & Co., of 152 Bay Street, Toronto, sole agents for Canada.

The branch office of H. B. Legge & Co., of London, England, situated for several years at the Tribune Building, New York, has recently been closed and the business transferred to 156 Yonge Street, Toronto, under the name of Gilbert B. Legge. Mr. Legge is the direct representative for several of the largest mills in Sweden, Norway, Germany and England, manufacturing all grades of wrapping, fancy and writing papers. Enquiries are solicited.



### BRITISH MARKETS.

London, April 29, 1912.

There is no improvement in the market for mechanical pulp, which continues weak. Stocks are by no means heavy, and makers anticipate more firmness on a resumption of active business by British papermakers.

The market for chemical pulps maintains its firmness, but little business is reported.

Business in chemicals, although considerably improved, is still restricted pending full supplies of coal. Ammonia alkali, 58 per cent., stands at £4 5s. to £4 10s. f.o.b. Liverpool; bleaching powder, £4 15s. f.o.r. Lancs; caustic soda (high-strength), £10 2s. 6d.; soda crystals, £2 12s. 6d.; and salt cake, £2 2s. 6d.

For house rags the demand is good, most mills having plenty of orders, and a good summer's business is anticipat-

ed. Most grades of foreign rags continue in steady demand and prices are firm.



### BRITISH ENQUIRIES FOR CANADIAN NEWS.

One of the results of the recent coal strike in this country was to divert to Canada enquiries for news for this market. We learn from Toronto that very little assistance can be hoped for from Canadian manufacturers as the output of their mills is in regular demand for the home market and the United States. The American market of late has been particularly active, and large supplies of news have been called for on account of the general expansion of trade and the coming Presidential election. Another point of some interest to consumers on this side is that the Canadian manufacturers regard the American market more favorably than the English, as business is held to be more profitable. During recent years the imports of Canadian paper into the United Kingdom have fallen off considerably; for instance, the receipts classified "for printing or writing" amounted to only £92,691 in 1910 as compared with £167,139 in 1906.—World's Paper Trade Review, London.



### PULP AND PAPER MARKETS.

Toronto, April.

All branches of trade in this country are in a buoyant condition, and the paper business is no exception to the general rule. All the new mills are running to full capacity, and prices are firm. There has been no specially noticeable upward movement, which has been checked, perhaps, by the feeling that with so many new outputs coming on the market shortly such would not be warranted. However, manufacturers have no fear of the production being over-large for the absorptive capacity of the market, and it is realized also that the increase could not come at a better

---

**EMERSON MANUFACTURING CO.  
LAWRENCE, MASS.**

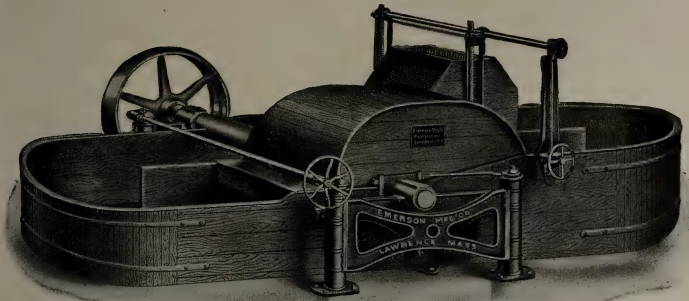

**Beating and Washing Engines  
Paper Mill Machinery**

---

**THE UNITED WIRE WORKS<sup>LTD.</sup>**

**Edinburgh, Glasgow & Newcastle on Tyne.**

**FOURDRINIER WIRES  
CYLINDER WIRES**

**Wire Cloth all meshes, in Brass, Copper Bronze & Steel.**

**SOLE AGENTS FOR CANADA**

**ARTHUR P. TIPPET & CO. 8 Place Royale, MONTREAL.**

**Wires held in stock at Montreal for prompt delivery.**

time, in view of the extra heavy demands from the United States on account of the presidential election.

Trade in the book and writing branches is fair to good. There is still considerable talk of a coming merger, so as to allow of greater specialization, which, it is believed, would result in smaller cost of production.

There is a slight advance in paper bags. Wrappings are in better demand, and so is Kraft. There is considerable complaint heard on the score of quality of some brands. The burning of the Crabtree mill has shortened the supply of manila.

Ground wood is being exported to the United States in much smaller quantities than has been the case during the last year or two. This is on account of the good water conditions in New England and elsewhere. There is very little evidence however, of any accumulation of stocks on this side, though the mills have been fully occupied. This is because of the fact that the domestic demand has been more than usually active, and this has absorbed a large proportion of the big output. Prices are likely to keep firm. Sulphite has advanced, partly because, it is said, of the coal strike in England:—

We quote:—

News print, rolled .....	\$1.90 to \$2.00
News print, sheets .....	2.15 to 2.25
Book papers—Carload lots	
No. 3 .....	4¼ to 4½c.
Book papers—Broken lots	
No. 3 .....	4½ to 4¾c.
Carload lots No. 2.....	4¾c.
Broken lots No. 2.....	5½ to 5¾c.
Carload lots No. 1.....	5½ to 6¼c.
Broken lots No. 1.....	6 to 6¾c.

#### Wrappings—

Manila B. ....	2½ to 3¼c.
Fibre . . . . .	3½ to 3¾c.
No. 2 Manila . . . . .	3¼ to 3¾c.
No. 1 Manila . . . . .	3½ to 4 c.
Kraft . . . . .	4¼ to 4¾c.

#### Pulp—

Ground wood (at mill)....	\$16 to \$18
---------------------------	--------------

Sulphite (bleached) .....	50 to 52
“ (unbleached) . . . . .	40 to 42

#### Waste Papers—

No.	Description	Per 100 lbs.
		F.o.b. Toronto.
No. 1	Hard White	
Shavings . . . . .		\$1.65 to \$1.75
No. 2	Hard White	
Shavings . . . . .		.....
White Envelope Cuttings . . . . .		1.65 to 1.75
No. 1	Soft White	
Shavings . . . . .		1.45 to 1.50
No. 2	Soft White	
Shavings . . . . .		1.25
No. 3	Soft White	
Shavings . . . . .		1.10
White Blanks . . . . .		1.10
Mixed Shavings . . . . .		35 to 37½c.
Heavy Ledger . . . . .		\$1.27½ to \$1.40
Ordinary Ledger . . . . .		1.00 to 1.10
No. 1	Flat Books . . . . .	80 to 90c.
No. 1	Book Stock . . . . .	75 to 80c.
No. 2	Book Stock . . . . .	39½ to 40c.
No. 1	Manila Envelope Cuttings..	\$1.20
No. 1	Print Manilas . . . . .	65c.
Railway Manilas . . . . .		55c.
Folded News Overissues . . . . .		45c.
Folded News . . . . .		45c.
Crushed News . . . . .		.....
No. 1	Mixed Papers . . . . .	25 to 35c.

#### Rags (New and Old)—

	Per 100 lbs.
1st Old White Cottons .....	\$2.00
2nd Old White Cottons .....	.....
Thirds and Blues . . . . .	\$1.25 to \$1.45
Roofing Stock —	
Flock Satinets . . . . .	75 to 80c.
Ordinary . . . . .	55 to 60c.
Tailor Sweepings . . . . .	55 to 57½c.
No. 1 White Shirt Cuttings	\$4.75 to \$5.00
No. 2 White Shirt Cuttings.....	.....
Fancy Sheet Cuttings.....	\$3.65 to \$3.75
New Blue Prints . . . . .	.....
New Blue Overalls.....	\$3.42½ to \$3.65
New Black Overalls.....	\$1.60 to \$1.70
New Black Linings.....	\$1.60 to \$1.75
New Unbleached Cottons . . . . .	.....
Bleached and Unbleached Shoe Clips...	.....
New Light Flannelettes..	\$3.75 to \$4.40
New Light Shirt Cuttings	\$3.90 to \$4.35
Light and Dark Cords.....	.....



Telephone: 2726 BROAD.

Cable Address: "LAGERLOF NEWYORK."

# Scandinavian-American Trading Company,

PRODUCE EXCHANGE BUILDING, NEW YORK,

IMPORTERS AND EXPORTERS OF

FOREIGN AND DOMESTIC

# WOOD PULP

OF ALL KINDS

AND

# PAPER MILL SUPPLIES.

HANS LAGERLÖF, PRES.

ALL KINDS OF  
Machines for Paper, Pasteboard,  
Cardboard, Cellulose  
and Pulp Mills

Paper Machines      Calenders  
Winders      Calender Roll Lathes  
Filters (Füllner's Construction)  
Cutters      Cone Refiners  
High Power Grinders      Patent Beaters  
Edge Runners

FIRST-CLASS REFERENCES

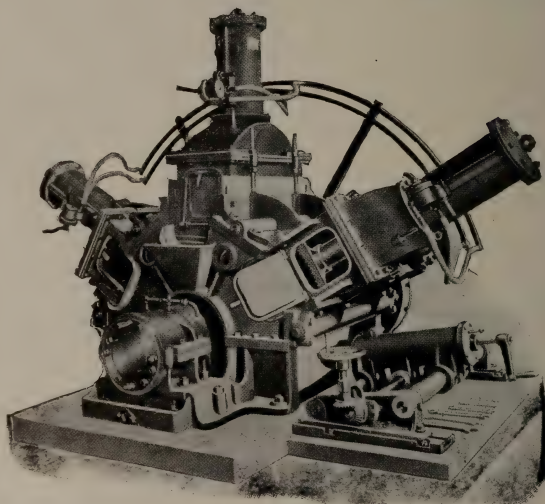

MOST MODERN CONSTRUCTIONS

Founded 1854

**H. FÜLLNER**

WARMBRUNN  
SILESIA  
GERMANY

Prizes won at all exhibitions where machines have been shown.  
Turin 1911 "Grand Prize." Paris 1900 "Grand Prix" und "Kreuz der  
Ehrenlegion." Leipzig 1897 "Gold Medaille." Paris 1907 "Grand Prix."

**CLASSIFIED ADVERTISERS' INDEX.**

If you fail to find what you want in these columns, write us and the desired information will be gladly supplied.

**Architects and Engineers**

Ambursen Hydraulic Con. Co.  
 Fred C. Anderson  
 Clark & Lyford  
 F. W. Dean  
 J. A. DeCew  
 Eaton & Brownell  
 Fibre Development Co.  
 Geo. F. Hardy  
 Herbert S. Kimball  
 International Process Co.  
 Arthur D. Little, Inc.  
 R. S. Lea & H. S. Ferguson  
 Lyford, Clark & Lyford  
 H. B. Prather  
 T. Pringle & Son  
 Stebbins Eng. & Mfg. Co.  
 R. O. Sweezey  
 Jos. H. Wallace & Co.

**Barkers.**

Carthage Machine Co.  
 Green Bay Barker Co.  
 Jenckes Mach. Co.  
 Waterous Engine Works.

**Barker and Chipper Knives.**

Crookes, Roberts & Co.  
 Peter Hay Knife Co.  
 A. P. Tippet & Co.

**Beaters.**

Dayton Globe Iron Works  
 Emerson Mfg. Co.  
 Holyoke Mach. Co.  
 E. D. Jones & Sons Co.  
 Valley Iron Works  
 Waterous Engine Works

**Beater Rolls.**

J. A. DeCew  
 J. Marx & Co.

**Belting.**

Dom. Belting Co.  
 General Supply Co.  
 F. Reddaway & Co.  
 Sadler & Haworth

**Bleaching Powders.**

Hooker Electro-Chemical Co.  
 Winn & Holland

**Bollers**

John McDougall Caledonian Iron Works

**Bond Papers.**

Northern Mills Co.

**Book Papers.**

Canada Paper Co.  
 Northern Mills Co.

**Brass Wire Cloth, Fourdrinier Wires.**

Geo. Christie, Ltd.  
 J. M. Douglas & Co.  
 Herman Finckh  
 C. H. Johnson & Sons, Ltd.  
 A. P. Tippet & Co.  
 United Wire Works.  
 P. P. Westbye

**Calender Rolls.**

Camel Hair Belting  
 F. Reddaway & Co.  
 Farrel Foundry & Mach. Co.

**Chemicals, Colors, etc.**

Brunner, Mond & Co.  
 Gewerkschaft Sachtleben  
 A. Klipstein & Co.  
 Paper Makers' Chemical Co.  
 United Alkali Co.  
 Wilson-Paterson Co.

**China Clay.**

Ahina Clay Co.  
 C. Klipstein & Co.  
 C. A. Meincke & Co.  
 Paper Makers' Chem. Co.  
 Wilson-Paterson Co.

**Chippers**

Carthage Machine Co.

**Coated Paper.**

Canada Coating Mills  
 Canada Paper Co.

**Conveying Machinery.**

Jeffrey Mfg. Co.

**Digester Lining.**

Panzl Digester Lining Co.  
 Preston's Digester Lining Co.  
 Stebbins Eng. & Mfg. Co.

**Digesters**

Swenson Evaporator Company

**Drainer Bottoms.**

Samuel Snell Co.

**Evaporators**

Ernest Scott & Co.  
 Swenson Evaporator Co.  
 Zarembo Company

**Exporters**

Parsons Trading Company

**Felts.**

F. Bredt & Co.  
 Dallyn, Jardine & Co.  
 Hamelin & Ayres Co.  
 C. H. Johnson & Sons, Ltd.  
 Penman's Ltd.  
 Joseph Porritt & Sons.  
 J. H. Spencer & Sons  
 A. P. Tippet & Co.

**Grinders.**

Carthage Machine Co.  
 Dayton Globe Iron Works  
 Glens Falls Mach. Co.  
 Holyoke Machine Co.  
 Jenckes Machine Co.  
 Waterous Engine Works.

**Kraft Paper.**

N. B. Pulp & Paper Co.

**News-Paper, Wrappings, etc.**

New Brunswick P. & P. Co.  
 Riordon Paper Co.

**Paper and Pulp Dealers**

Atterbury Bros.  
 Albert E. Mallandian  
 Castle, Gottheil & Overton.  
 Parsons Trading Co.  
 Pulp and Paper Trading Co.  
 A. Wertheim & Co.  
 Riordon Paper Co.

**Paper Stock, Rags, etc.**

Atterbury Bros., Inc.  
 J. Christie Co.  
 R. Hough  
 The Howell Co.  
 E. Pullan  
 J. R. Walker & Co.

**Paper and Pulp Mill Machinery.**

Appleton Machine Co.  
 W. G. Ashdown  
 Baker & Shevlin Co.  
 Beloit Iron Works  
 Bentley & Jackson  
 James Bertram & Son, Ltd.  
 Bertram's, Limited  
 The Black-Clawson Co.  
 Canadian Boving Co.  
 Carthage Machine Co.  
 Dayton Globe Iron Works Co.  
 Dillon Machine Co.  
 Emerson Mfg. Co.  
 Farrel Foundry & Machinery Co.  
 M. Garland Co.  
 Glens Falls Machine Works.  
 Green Bay Barker Co.  
 Harmon Machine Co.

**Holyoke Machine Co.**

Jenckes Machine Co.  
 E. D. Jones & Sons Co.  
 C. H. Johnson & Sons, Ltd.  
 Jas. Milne & Sons.  
 Moore & White Co.  
 Marx, J. & Co.  
 B. F. Perkins & Son.  
 Rice, Barton & Fales  
 Ryther & Pringle.  
 Sandy Hill Iron & Brass Works.  
 Ernest Scott & Co.  
 Sherbrooke Machinery Co., Ltd.  
 S. Morgan Smith.  
 Stebbins Engineering & Mfg. Co.  
 Swenson Evaporator Co.  
 Ticonderoga Machine Works.  
 Valley Iron Works.  
 J. M. Voith.  
 Charles Walmsley & Co.  
 Chr. Wandel.  
 Wandel Screen Mfg. Co.  
 Waterous Engine Works Co. Ltd  
 P. P. Westbye.  
 Zarembo Co.

**Paper Testers.**

Dobler & Mudge.

**Pipes (Wooden)**

Eastern Pipe & Construction Co

**Pumps.**

Carthage Machine Co.  
 Lawrence Machine Co.  
 Lawrence Pump & Engine Co.  
 John McDougall Caledonian Iron Works.  
 Smart-Turner Mach. Co.

**Rosin Size.**

Paper Makers Chemical Co.  
 Vera Chemical Co.  
 United Alkali Co.  
 Wilson-Paterson Co.

**Screen Plates.**

Union Screen Plate Co. of Can.

**Screens.**

W. G. Ashdown  
 Harmon Machine Co.  
 Sherbrooke Machinery Co.  
 J. M. Voith.  
 Chr. Wandel.  
 Wandel Screen Mfg. Co.  
 Waterous Engine Works.  
 P. P. Westbye.

**Sulphur.**

Union Sulphur Co.

**Tanks.**

John McDougall Caledonian Iron Works

G. Woolford Wood Tank Mfg. Co

**Transmission Machinery.**

Dodge Manufacturing Co.

**Travelling Cranes.**

Advance Mach. Co.  
 Hugh R. Blethen  
 Northern Eng. Co.  
 Nmart-Turner Mach. Co.

**Turbines.**

Dayton Globe Iron Works.  
 S. Morgan Smith Co.

**Water Wheels.**

John McDougall Caledonian Iron Works  
 Dayton Globe Iron Works.  
 Holyoke Machine Co.

**Wood Pulp Agents.**

Castle, Gottheil & Overton  
 Churchill & Sim  
 Parsons Trading Co.  
 Scandinavian Amer. Trading Co.  
 A. Wertheim & Co.

# PAPER AND CLOTH SPECIALTIES

For Rent and Club Cards, Pattern Cards, Map Printing,  
Label Printing, Envelopes, Etc., Etc.

*Cloth Lined Papers. Cloth Centred Papers and Boards. Cloth Lined, Chromo and Enamel. Cloth Lined Boards and Cards, (surfaced and enamelled). Cloth centred Boards, (surfaced and enamelled). Manilla Surfaced Boards and Cards.*

ALSO

*Enamelled Blotting.  
Art Papers.*

*Paste Boards.  
Chromo and Surface Papers.*

Customers' requirements in specialities are carefully considered and experiments conducted if necessary.

**ALBERT E. MALLANDAIN,**  
MANUFACTURER

OFFICES : 51 Cheapside  
London, E.C.

MILLS : Park Royal  
Willesden, London, N.W.

## HERMANN FINCKH

REUTLINGEN

*Established 1879*

GERMANY

---

# FOURDRINIER WIRES

---

**SULPHITE - MACHINE WIRES**  
**CYLINDER WIRES**

---

**P. P. WESTBYE, - Peterborough, Ontario**

*Sole Agent for Canada*

IMPROVED WARREN PATENT

# Double Drum Winder

With Slitter Attachment Combined

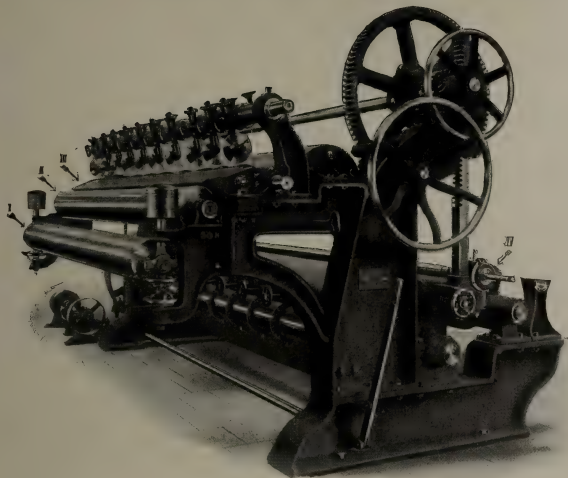

REAR VIEW SHOWING SLITTERS.

REFERENCE :

- I—8-inch Brass Spring Roll.
- II—8-inch Brass Carry Roll
- III—8-inch Adjustable Draw Board.
- IV—Adjustable Core Shaft Box.

Compare this Winder with Others

BUILT BY

## Ticonderoga Machine Works

TICONDEROGA, N.Y., U.S.A.



## THE PERKINS BRONZE SIZE PUMP

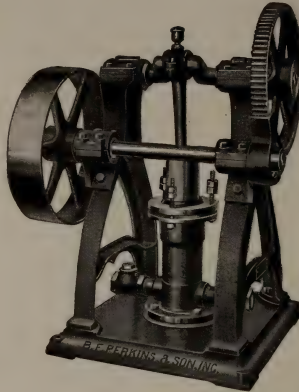

The simplest and most efficient means for pumping Size to a Paper Machine. Will last a lifetime. Write for special circular with list of references.

**B. F. PERKINS & SON, Inc.,** - **HOLYOKE, MASS.**

## FROZEN PULP AND DRY PULP IN A

# Ryther Shredder

Is shredded at the rate of 5 tons per hour.  
17 to 25 H. P. required. The above figures are  
*dry weight* and absolutely guaranteed.

RELIEVE YOUR BEATERS and INCREASE QUALITY  
and PRODUCTION. Write for full Particulars.

---



---

**Ryther & Pringle Company**  
Carthage, N.Y.

# WORTHINGTON STEAM PUMPS

FOR BOILER FEED, FIRE  
AND GENERAL SERVICE

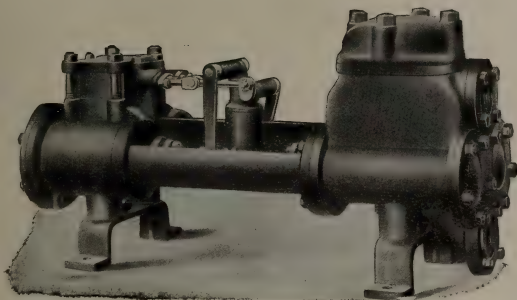

**Kept in Stock**

---

Works: William and Seigneurs Sts., Montreal

---

**THE JOHN McDOUGALL,  
CALEDONIAN IRON WORKS CO.,**

LIMITED

**PRESTON'S**

# Lining for Sulphite Digesters

TOTAL THICKNESS ONLY 2½ TO 2¾ INCHES

Resists the action of the acid and ensures absolute protection to the Digester Plates.

Great durability, therefore large saving in upkeep and repairs.

Larger internal space and increased production on account of the small thickness occupied.

Extensively adopted by Scandinavian and Continental Mills.

Over 200 Digester Linings in work and on order.

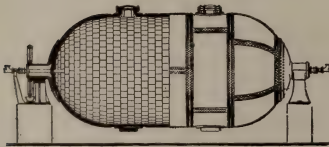
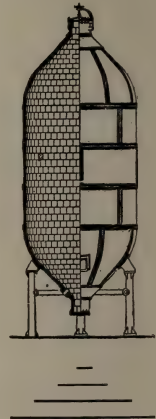

Telegraphic Address :

**"PRESTONS, RADCLIFFE."**

CODE USED A.B.C., 4TH & 5TH EDITION.

*Full Particulars and Prices on application to SOLE MANUFACTURERS*

## PRESTON'S DIGESTER LINING CO., LIMITED

RADCLIFFE, near Manchester, Eng.

---

---

FARREL FOUNDRY AND MACHINE  
COMPANY

ANSONIA, CONN., - - U. S. A.

Largest Manufacturers in the world of

**CHILLED ROLLS**

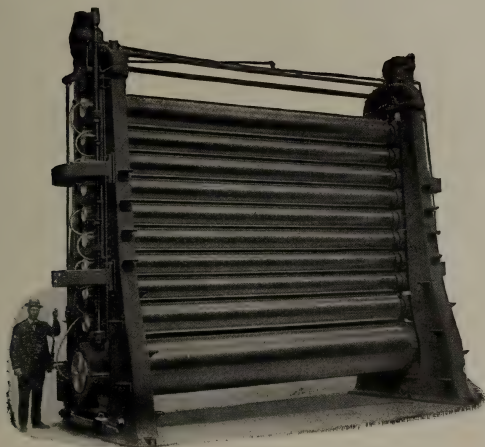

**CALENDERS**

*WITH PATENT HYDRAULIC LIFT*

**ROLL GRINDING MACHINES**



---

---

Would YOU like to enlarge your Business and find new Customers in all parts of the world? If so, ADVERTISE in

# “THE PAPER-MAKER AND BRITISH PAPER TRADE JOURNAL.”

THE LEADING AND MOST POPULAR TRADE ORGAN.

THE ADVERTISER  GOOD FOR  THE READER

We recently received the following letter:—

“We have hesitated over the matter, as we are at present so busy as to regard further advertising as almost superfluous.

“On the whole, however, we find it pays us better to have to refuse orders than to hunt after them, and will ask you therefore to insert our advertisement on same terms as last.

“We enclose herewith amended matter for advertisement, and shall be glad to have proof of same at your early convenience.”

We are constantly in the receipt of gratifying letters relative to the usefulness of our Journal, and we have pleasure in printing the following:

“Gentlemen,

We beg to advise that we have not as yet received the June number of ‘THE PAPER-MAKER AND BRITISH PAPER TRADE JOURNAL.’

We like the publication so well that we should be very sorry indeed to miss a copy of it.

Thanking you in advance for your kind attention,

We are, dear Sirs, yours very truly,  
F. R. KEYES & SON.  
20 Broad Street, New York.”

## S. C. PHILLIPS & Co.'s STANDARD PUBLICATIONS

### The Paper-Maker

AND BRITISH PAPER TRADE JOURNAL.

Published on the 1st of each month. Price 1s., by post 1s. 6d. Annual Subscription 12s. 6d. post free.

### The Stationery World, Printing and Allied Trades,

AND FANCY GOODS REVIEW.

Published on the 25th of each month. Price 6d. by post 7d. Annual Subscription 5s. post free.

Chief Offices:

47 CANNON STREET, LONDON, E.C. (ENGLAND).

### The Paper Box and Bag Maker.

Published on the 19th of each month. Price 6d., by post 7d. Annual Subscription 6s. 6d. post free.

### Phillips' Paper Trade Directory of the World.

15s. 6d., post free to all countries.

NEW EDITION FOR 1911 NOW READY.

Specimen Copies and Advertisement Rates  
FREE OF APPLICATION.



# “LAWRENCE” Centrifugal Pumps

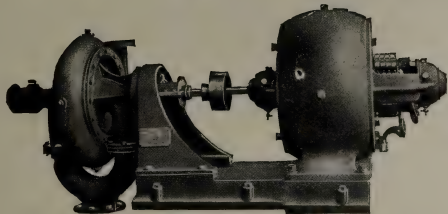

High-grade Pumping Machinery  
for all Purposes

PAPER MILL WORK  
A SPECIALTY

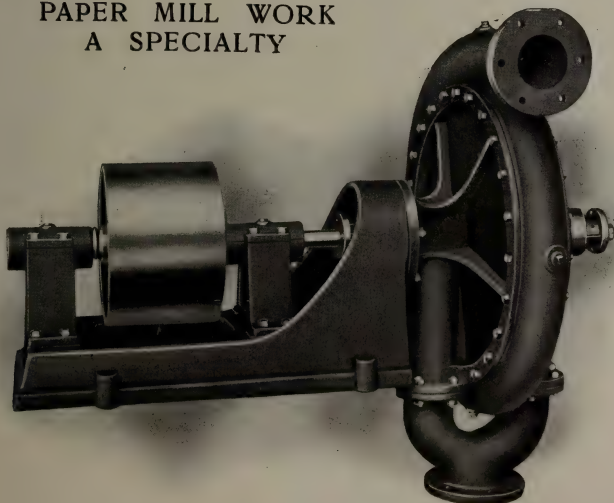

Let us figure on your requirements

**Lawrence Machine Company**  
LAWRENCE                      MASS.

**PULP MILL CHEMIST** with twelve years' experience in Sulphite (Bleached and Unbleached), wants similar position, good draughtsman. Apply Box 30, Pulp and Paper Magazine.

**UNDER MANAGER.**—Young man, 14 years' practical experience in English mill making long elephants, news, all-wood printings, cream laids, etc. Experienced mill chemist—testing of papers, fibres, etc. Highest references. Address H. C., c/o Pulp and Paper Magazine.

As we are using all our Water Power at our Pulp Mill for electricity, we are disposing of the Pulp Mill Machinery—including Millard Patent Grinders which were in use only a few months and are absolutely as good as new, also Wet Machines, Barkers, Screens, Pumps, Piping, Shafting, Stones, etc., etc., all in good condition. Full information will be given upon application.

Apply Box "A,"

Pulp and Paper Magazine,

Toronto.

**A GENTLEMAN** from Scotland, resident in Toronto, having had practical experience in all departments of paper making, would like to hear from firms to whom his services might be of use. He has had wide and varied experience "on the road" in the printing and stationery trades, also in the manufacture of paper bags. Box (S.W.), Pulp and Paper Magazine.

**FOR SALE.**—Special Second-hand Cylinder Mould, 48-in. diameter, 84-in. face. Good as new. Can be used as Filter. For particulars, etc., address Box 32, Pulp and Paper Magazine.

**WANTED.**—Superintendent for a new 150-ton ground wood mill. One with technical education preferred. Please state education and experience in full; also give age, if married or single, and salary asked for. Address Box 27, care Pulp and Paper Magazine, Toronto.

**PAPER MILL ENGINEER.**—Technical graduate, ten years' experience, now consulting engineer for one of the largest paper mills in United States, wants change. Open for engagement in near future. Will give part or whole time. Apply Box 26, Pulp and Paper Magazine., Toronto.

**WANTED IMMEDIATELY**—Master mechanic, machinists, millwrights and pipefitters for Canadian soda, pulp and paper mill now under construction. Only experienced men need apply. State wage and give references. Apply Box D, Pulp and Paper Magazine.

**AGENT WANTED,** by a London firm of Paper Merchants wishing to extend their business in Canada. All classes of English and foreign papers handled. Address with full particulars and references to Box 31, c/o Pulp & Paper Magazine.

**GEWERKSCHAFT SACHTLEBEN**

Homburg-Niederrhein

GERMANY

Largest Makers  
of all Qualities

**Blanc Fixe**

Bright

Matt or Dull

Photographic

Three  
Varieties

SCOTT'S IMPROVED RECOVERY SYSTEMS  
 FOR  
**SODA, SULPHATE & SULPHITE**

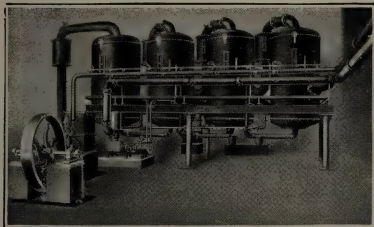

Spent Liquors give the  
**MAXIMUM ECONOMY**  
**AND EFFICIENCY**

The PRINCIPLE,  
 The DESIGN,  
 The CONSTRUCTION,  
 The OPERATION,  
 The RESULT,

**Is RIGHT**

Complete installations made by "THE FIRM WITH THE EXPERIENCE."

**ERNEST SCOTT & CO.** Manufacturing  
 Engineers

FALL RIVER, MASS. and MONTREAL, P.Q.

**SODA OR SULPHATE**

RECOVERY SYSTEM  
 MAXIMUM EFFICIENCY      MINIMUM LOSSES

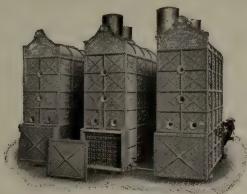

WELDED DIGESTERS      MULTIPLE EFFECT EVAPORATORS  
 AND OTHER PULP MILL EQUIPMENT

**SWENSON EVAPORATOR CO.**

945 Monadnock Bldg. . . . . CHICAGO

HIGH GRADE  
**"VICTORIA" TURBO PUMPS**

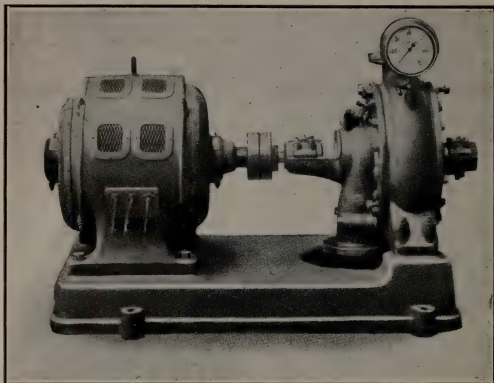

Suitable  
 for all condi-  
 tions. Water,  
 pulp, caustic  
 or acid. High-  
 est efficiency  
 Flat charac-  
 teristic curve.  
 Un r ivall ed  
 workmanship.

**THE CANADIAN BÖVING COMPANY, LTD.**  
 164 BAY STREET : : : : TORONTO

## A GOOD JORDAN ENGINE

BUILT IN 3 SIZES.

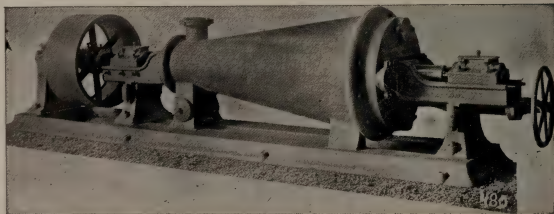

## THE BLACK-CLAWSON CO.

HAMILTON, OHIO, U.S.A.

Builders of **PAPER MAKING MACHINES** and machinery  
 for Paper and Pulp Mills. Our machines are completely erected in shop  
 on cast iron levelling plates and carefully inspected before shipment.

*Write for Catalogue.*

Established  
1869

**CHR. WANDEL,**

Established  
1869

REUTLINGEN . . . GERMANY

Paper Machine Wire and Engineering Works

SOLE MANUFACTURER OF

The Original "WANDEL" Rotary Screen

Over  
3,000  
Apparatus  
Sold

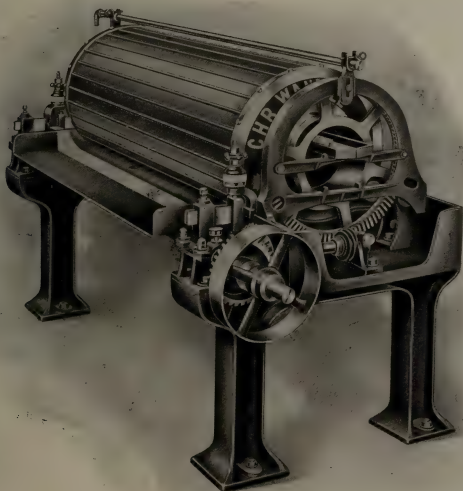

No authorized  
builder in  
Canada  
or the States

**ADVANTAGES:**

Regular output of Pulp

Automatic removal of Knots

Large working ability

Avoidance of Stoppage

Less Power . . . Great Strength and Durability

Suitable for all classes of Paper

**Agent for Canada Wanted**



# TOWNSEND

## ELECTROLYTIC CELL

2,500-5000 AMPERE UNITS. ALKALI AND CHLORINE.  
CAUSTIC SODA. BLEACHING POWDER. CHLORINE  
FOR ORES. LICENSES GRANTED. CANADIAN PATENTS  
91939 - 105088 - 105089.

**HOOKER ELECTROCHEMICAL COMPANY**  
40 WALL STREET, NEW YORK

## ZAREMBA EVAPORATORS

FOR RECOVERY OF

## SULPHATE OR SODA

*Horizontal Tubes*    *Automatic Feed Regulators*    *Easily Operated*  
*No Liquor Losses*    *Everything Accessible*    *Cheaply Maintained*

**ZAREMBA CO., BUFFALO, U.S.A.**

## Paper Coating and Colouring Machines

COMPLETE PLANTS AND ACCESSORIES

The best in the world.

To be obtained from

**Julius Fischer** Engineering Works **Nordhausen, H.**

GERMANY

*Excellent References in all countries.*

If you have not ordered a copy of the new  
"Canadian Pulp and Paper Directory,"  
do it now. Your promptness will save you \$1.  
The price to non-subscribers, after publication,  
will be \$3. To subscribers before publication \$2.

Address :

**BIGGAR-WILSON, LIMITED**  
Confederation Life Bldg., TORONTO

VALLEY IRON



WORKS COMPANY

# BEATING AND WASHING ENGINES

IRON OR WOOD TUBS

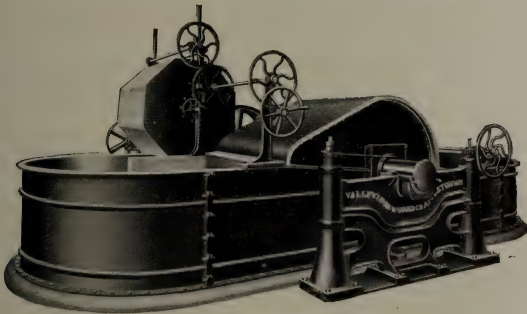

*Perfection in Every Detail.*

Beating, Washing and Bleaching Engines. Barkers—Barker Attachments—Chippers—Rechippers—Chip Screens (Revolving)—Knot Screen (Revolving)—Diaphragm Screens—Felt Washers—Deckers (Single and Double)—Stuff Chests (Vertical and Horizontal)—Tanks (Blow Off, Acid and Water)—Pulpwood Saws (Friction and Steam Feed)—Pulpwood Splitters (Vertical and Horizontal)—Shredders and Special Washers for old Paper Stock—Wet Machines and Patent Roll Skinners—Bronze, Semi-Steel, Lead and Iron Castings.

Manufacturers of Paper and Pulp Making Machinery in

*All Standard Forms — Many Special Designs*

**ENGINEERS, FOUNDERS AND MACHINISTS**

*Correspondence Invited*

**VALLEY IRON WORKS COMPANY**

**APPLETON, WIS., U.S.A**

**CROOKES, ROBERTS & Co.****SHEFFIELD****ENGLAND**

Makers of  
**Crucible Cast Steel**  
**Bed Plates**  
**Jordan Fillings**  
**Beater Bars**



Makers of  
**Bessemer Cast Steel**  
**Crookes' Composition**  
**Fillings**

And every description of Cutler Knives, Tools and Steel used  
 and required in Paper Mills.

**ARGUS High-Speed STEEL** for fine machine tools is  
 unsurpassed.

Once Used - Always Used  
**YOU SAVE MONEY USING "ARGUS" GOODS**

WRITE US

**ARTHUR P. TIPPET & CO.**

Agents for Canada

**MONTREAL**

**SPENCER'S**

ALWAYS



RELIABLE

Best Wool - Best Weave - Best Wear

**J. H. SPENCER & SONS**

**BURY ENGLAND**

Canadian Agents: **ARTHUR P. TIPPET & CO., MONTREAL**

# INDEX TO ADVERTISEMENTS.

(SEE CLASSIFIED ADVERTISERS INDEX ON PAGE XXIX.)

Ambursen Hydraulic Construction Co.....	lxiii	Dominion Belting Co. ....	xliv
Anderson, F. C.....	lvi	Eaton & Brownell.....	lvi
Appleton Machine Co.....	vi	Emerson Mfg. Co.....	xxv
Atterbury Bros. Inc.....	lx	Farrel Foundry & Machine Co. ....	xxxv
Baker & Shevlin Co.....	vii	Fischer, Julius.....	xliv
Becker & Co.....	liii	Finckh, Hermann.....	xxx
Beloit Iron Works.....	xiii	Fullner, H.....	xxviii
Bentley & Jackson.....	v	Garland, M. Co.....	xii
Bertram, James & Son., Ltd.....	xviii	Gewerkschaft Sachtleben.....	xxxviii
Bertram's, Limited.....	xlvii	Gillespie, Geo. H. Co.....	lxiii
Black-Clawson Co., The.....	xl	Glens Falls Machine Works.....	iv
Blethen, Hugh R., The.....	lviii	Green Bay Barker Co.....	xxi
Bredt & Co., F.....	xlvii	Hamelin, The, & Ayers Co., Ltd.....	lviii
Brunner, Mond & Co., Limited.....	lxiv	Hardy, Geo. F.....	lvi
Canada Coating Mills, Limited.....	lv	Harmon Machine Co.....	viii
Canada Paper Co., Ltd.....	lv	Hay Knife Co., Peter, Limited.....	lix
Canadian Boomer & Boschert Press Co.....	lviii	Holyoke Machine Co.....	xvi
Canadian Boving Co.....	xl	Hooker Electrochemical Co.....	xlii
Carthage Machine Co.....	xxiv	Horn, J. H. & Son.....	xx
Castle, Gottheil & Overton.....	l	Hough, R.....	lxiv
Chicoutimi Pulp Co.....	liii	Howell Co., The.....	xlvi
China Clay Co.....	xlviii	International Process Co.....	xliv
Christie, J. Co.....	lxiv	Jeffrey Mfg. Co.....	iii
Christie, Limited, George.....	lxiii	Jenckes Machine Co.....	xvii
Churchill & Sim.....	lx	Johnson & Sons, Limited, C. H.....	xlvii
Crookes, Roberts & Co.....	xliv	Jones, E. D. & Sons Co.....	lii
Crossley, T. L.....	lvi	Jones & Glassco.....	xx
Dallyn, Jardine & Co.....	l	Kimball, Herbert S.....	lvii
Dean, F. W.....	lvi	Klipstein & Co., A.....	xlviii
Dillon Machine Co.....	xiv		
Dobler & Mudge.....	vi		
Dodge Mfg. Co.....	iv		

## HYDRAULIC TURBINES

One unit of six with a total capacity of 13,100 Horse Power furnished for the new plant of J. R. Booth, Ottawa, Ontario. We build Turbines for any power for heads from 3 to 600 feet.

WRITE FOR CATALOGUE



**S. MORGAN SMITH CO.,**  
**YORK - PA.**

Lawrence Machine Company..... xxxvii  
 Lawrence Pump & Engine Co..... 1  
 Lea, R. S. & H. S. Ferguson..... lvi  
 Little, Arthur D. Inc..... lvi  
 Lyford, Clark & Lyford..... lvi

Mallandain, Albert E..... xxx  
 Marx, J. & Co..... xviii  
 Mardon, Alfred H..... lviii  
 McDougall, John, Caledonian Iron Works  
 Co., Limited..... xxxiii  
 Milne, Jas., and Son..... 169  
 Moore & White Co..... xv

National Pipe & Foundry Co., Ltd..... xlviii  
 New Brunswick Pulp and Paper Co., Limited..... liv  
 Northern Engineering Works..... lxiv  
 Northern Mills Co..... liv

Panzl Digester Lining Co..... liv  
 Paper Makers Chemical Co..... lix  
 Parsons Trading Co..... xxiv  
 Penman's Limited..... 1  
 Perkins, B. F. & Son..... xxxii  
 Phillips, S. C. & Co..... xxxvi  
 Porritt & Son, Joseph..... 1  
 Porritt Bros. & Austin..... xlvii  
 Prather, H. B..... lvii  
 Preston's Digester Lining Co., Limited..... xxxiv  
 Pride, Chas. B..... lvii  
 Pringle, T. & Sons..... lvi  
 Pullan, E..... lii  
 Pulp & Paper Trading Co., The..... lix

Reddaway, F. & Co..... lii  
 Rice, Barton & Fales..... ii  
 Riordon Paper Co., Limited..... lv  
 Ryther & Pringle..... xxxii

Sadler & Haworth..... ii  
 Sandy Hill Iron & Brass Works..... x  
 Scandinavian American Trading Co..... xxxvix  
 Scott Ernest & Co..... xxxix  
 Sherbrooke Machinery Co., Limited..... xix  
 Smart-Turner Machine Co..... lxiv  
 Smith, S. Morgan, Co..... xlv  
 Snell, Samuel Co..... xlviii  
 Spencer, J. H. & Sons..... xlv  
 Stebbins Engineering & Mfg. Co..... lvii  
 Swezey, R. O..... lvii  
 Swenson Evaporator Co..... xxxix

Taylor, J. A..... lxiii  
 Ticonderoga Machine Works..... xxxi  
 Tippet, Arthur & Co..... xxv - xlv

Union Screen Plate Co..... liii  
 Union Sulphur Co., The..... lix  
 United Wire Works, Limited..... xxv

Valley Iron Works..... xliiii  
 Vera Chemical Co..... lx  
 Voith, J. M..... vii

Walker, J. R. & Co..... lx  
 Wallace, Jos. H. & Co..... lvii  
 Walmsley, Charles & Co..... xxii - xxiii  
 Wandel, Chr..... xli  
 Wandel Screen Mfg. Co..... lx  
 Waterous Engine Works Co., Limited..... lxii  
 Wertheim & Co., A..... lxi  
 Westbye, P. P..... xi - xxi  
 West End Engine Works Co..... x  
 Wilson, Paterson & Co..... xxiv  
 Winn & Holland..... lxiv

Zarembo Co..... xlii

**KRAFT PULP**



**MADE IN SWEDEN**

The best Pulp for making

**KRAFT BROWN PAPER**

Sole Selling Agents, United States  
and Canada

**THE HOWELL CO.**

8-10 Wellington St., East

**TORONTO - CAN.**

**MAPLE LEAF**  
**STITCHED COTTON DUCK**  
**BELTING**  
**DOMINION BELTING CO. LTD.**  
**HAMILTON CANADA**



You can Purchase  
Thoroughly Up-to-date  
**Paper Mill Machinery**

and the Strongest Type of  
**FAST-RUNNING PAPER**  
**MAKING MACHINES**

FROM

**Bertrams Limited**

SCIENNES  
EDINBURGH

CANADIAN OFFICE, 152 BAY ST., TORONTO

**C. H. JOHNSON & SONS, Ltd.**

WIRE WORKS, ST. HENRY, MONTREAL.

MANUFACTURERS OF

**Fourdrinier Wires, Cylinder Wires,  
Brass, Copper and Iron Wire Cloth, Dandy Rolls**

**PORRITT BROR. & AUSTIN**

Stubbins Vale Mills—RAMSBOTTOM—near Manchester, England

Manufacturers of every description of

**FELTS AND JACKETS FOR  
PULP AND PAPER MILLS**

Agents for Canada: C. H. JOHNSON & SONS, Ltd., ST. HENRY, MONTREAL

**WE MANUFACTURE Wooden Water Pipe** for Water Works Systems. **Specially Made Pipe** for conveying Chemicals. **Continuous Stave Pipe** or Power Plants. Sizes from 2 inches to 12 feet diameter.

**NATIONAL PIPE AND FOUNDRY CO., LIMITED**

Works—ALEXANDRIA, Ont.

135 Board of Trade Bldg., MONTREAL, Que.

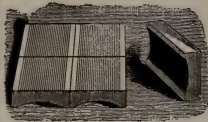

### Use Snell's Drainer Bottoms

They drain quickly and don't let the Pulp go into River. **No Dust. No Splinters. Clean Stock.**

*Send for Sample and Price.*

**Samuel Snell Co., - Holyoke, Mass.**

Cable Address:—"Kaolin, Manchester." A.B.C. Codes 4th & 5th Edition

# CHINA CLAY CO.

JOHN WILLIAMSON, Manager.

4 St. Anne's Square

**MANCHESTER, ENG.**

**MINES**—Ruddle, Bojea, Colchester, South Ninestones, Tronance, St. Austen Cornwall.

**CONTRACTORS TO H.M. INDIAN GOVERNMENT**

Canadian Representatives—C. A. Meincke & Co., 222 Coristine Bldg., Montreal.

## A. KLIPSTEIN & Co. Ltd.

(OF CANADA)

12 ST. PETER ST.

MONTREAL

# SULPHATE ALUMINA

**CHINA CLAY, BLEACH and CASEIN  
PAPER BLUE, both Basic and Acid  
AURAMINE - RHODAMINE**

and all other Aniline Colors

Shades Carefully Matched in our Laboratory

Mention Pulp & Paper  
Magazine

New York Office - 644-654 Greenwich Street.

THE PROCESSES AND APPARATUS  
THAT MADE "KRAFT PAPERS" SUCCESSFUL



CABLE ADDRESSES  
KRAFTLICH, NEW YORK  
INPROKRAFT, LONDON.

AMERICAN OFFICES  
5 BEEKMAN STREET  
NEW YORK, N.Y.

EUROPEAN OFFICES  
SALISBURY HOUSE,  
LONDON, ENGLAND.

SOLE AGENTS IN NORTH AMERICA  
FOR  
CARL P. CARLSON, SWEDEN.  
EVAPORATORS AND LIQUOR SYSTEMS.

JULIUS PINTSCH, ACTIENGESSELLSCHAFT, GERMANY.  
DIGESTERS, DIFFUSERS AND SPECIALTIES.

SWEDISH SYSTEM OF RECOVERY FOR  
TURPENTINE, ALCOHOL AND OTHER BY-PRODUCTS.

# INTERNATIONAL PROCESSING CO.

ENGINEERS, CHEMISTS, PULP EXPERTS.

## LAWRENCE PUMP AND ENGINE CO.

P.O. BOX 70, DEPT. 10  
LAWRENCE :: MASS.

### CENTRIFUGAL PUMPS

We make an exclusive specialty of High Efficiency Centrifugal Pumps for Paper and Pulp Mill. In one mill 49 of our Pumps are running, the customer writes—"Your Pumps are all giving perfect satisfaction."



ESTABLISHED 1808.

REGISTERED.

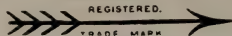

## FELTS For Pulp and Paper Mills.

### JOSEPH PORRITT & SONS

Agents for  
Canada  
and United  
States.

HELMSHORE

Manchester, England.

All kinds  
Woollen, Lin-  
en and Cotton  
Cloths for  
Mechanical  
Purposes.

F. BREDT & CO., 240 Water Street, NEW YORK.

## PENMANS LIMITED

ST. HYACINTHE, QUEBEC

Manufacturers of

PULP AND PAPER MAKERS' FELTS,  
JACKETS, STRAINER CLOTHS, ETC.

Special sizes and qualities made to order. Satisfaction guaranteed.  
DALLYN, JARDINE & CO. TORONTO Selling Agents

## CASTLE, GOTTHEIL & OVERTON

200 Fifth Avenue, New York

AGENTS FOR

**Sulphite and Wood Pulp Mills**

Dealers in all kinds of Paperstock, Sizing, etc.

Correspondence Solicited.

# “AMPHIBIA”

(WATERPROOF)



## Leather Belting

is the kind that costs you Less Per Day of Service and, therefore, the cheapest in the long run.

This “cost-per-day-of-service” basis is the only one to use when figuring out your belting costs. Our belts may cost a little more at first but they last longest. What’s more,—“AMPHIBIA” Belting is absolutely unaffected by moisture.

MADE ONLY BY

*Sadler & Haworth*

Tanners and Manufacturers.

MONTREAL  
511 William St.  
ST. JOHN, N.B.  
89 Prince William St.

TORONTO  
27 Melinda St.  
WINNIPEG  
244 Princess St.

VANCOUVER  
217 Columbia Ave.

For over thirty-five years the makers of the best leather belts.



Nearly FIFTY YEARS ago we introduced this Belt. IT HAS STOOD THE TEST OF TIME

2" to 24" in stock

Every Belt is  
Stamped with  
Trade-Mark.



Write or phone us

Beware  
of Imitations

SOLE MAKERS

F. REDDAWAY & CO.,

MONTREAL, CANADA.

**E. PULLAN,** 490 Adelaide St. W.,  
TORONTO

Largest Paper Stock Dealer in Canada

**RAGS AND PAPER STOCK GRADED TO SUIT MILL REQUIREMENTS**

Correspondence Solicited.

Edward A. Jones, President and Treasurer.

Wallace E. Bardwell, Secretary

**F. D. JONES & SONS CO.,** Pittsfield, Mass.

Manufacturers of

**PAPER MAKING MACHINERY  
AND MECHANICAL ENGINEERS**

Beating Engines. Washing Engines. Mixing Engines. Bleaching Engines.  
Cooking Engines. Vertical and Horizontal Stuff Chests.

Jordan Engines of three sizes, either belt or direct-connected motor-driven ;  
fillings of Wagg Steel or stone type, three-part or plain.  
Dusting Machinery of all kinds.

SECOND AND ENLARGED EDITION

# THE PAPERMAKERS' POCKET BOOK

Specially Compiled for

PAPER MILL OPERATIVES, ENGINEERS, CHEMISTS,  
AND OFFICIALS

By JAMES BEVERIDGE

- ☞ This new edition contains more exhaustive chapters on Raw Fibrous Stock, such as Cotton and Linen Rags, Esparto, Bamboo, Megass or Crushed Sugar Cane, etc.
- ☞ The chapter on Wood Cellulose Manufacture by the Soda, Sulphate, and Sulphite methods has been amplified. Very complete information has been given of Soda Recovery, Causticising and Composition of Recovered Soda Liquors.
- ☞ A new but brief chapter has been added relating to Loading Materials.
- ☞ The chapter on Chemical Analysis has been enlarged.
- ☞ It will be found that the additional matter is given in concise form, is of a highly practical nature, and is not generally found in English text books.

PRICE, \$3.50

**BIGGAR-WILSON, LTD.,** TORONTO

PRIME . . .  
CANADIAN CHICOUTIMI,  
P.Q., CANADA.  
SPRUCE PULP

SUPPLIED BY THE

**CHICOUTIMI**  
**Pulp Co.**

Production: About 100,000 tons.

SOLE AGENTS:

**BECKER & CO.**

LIMITED

**64 CANNON ST., - LONDON.**

# THE NORTHERN MILLS COMPANY

**Paper Manufacturers. Printing and Writing Papers.**

Super-Calendered, Velvet and Machine Finished Book, Litho and Antique Printing, Engine Sized Writing and Envelope Papers, White and Tinted Bond. Typewriter Papers (Glazed and Rough Finish). Writing Tablets and Envelopes.

Ask for "Canadian Bond," "Provincial Bond," "Adella," and "Northern Mills."

**Head Office:**

**Montreal, 278 St. Paul Street.**

**Mills:**

**St. Adele, Que.**

## Genuine "KRAFT" Papers MADE IN CANADA

**THE NEW BRUNSWICK PULP & PAPER CO., LTD.**

**Springfield Mills, Millerton, N.B.**

**TORONTO, 182 Adelaide St. W.**

**MONTREAL, 404 St. Nicholas Bldg.**

## PANZL'S PATENTED LINING COMPOSITION

IS THE SAFEST AND BEST MATERIAL FOR

**LINING OF SULPHITE PULP DIGESTERS**

AND ACID RECLAIMING TANKS

**PANZL LININGS ARE SAFEST AND  
MOST DURABLE**

They are really acid-proof and practically indestructible.

All Digesters lined with Panzl's patented composition, now as tight and in as good condition after years of continuous use as they ever were, no leaks and no repairs.

Panzl Linings can be made considerably thinner than the other linings, thus increasing the capacity of the digesters.

The composition and the system of constructing of Panzl Linings are patented in all countries where wood pulp is being manufactured by the sulphite process. The PANZL U.S. Patents have been adjudicated to be valid in law and wholly independent of all prior patents relating to linings of digesters.

For information and estimates, address:—

**PANZL DIGESTER LINING COMPANY**

**505 Washington Ave., Muskegon, Mich.**

## The Riordon Paper Company, Limited Fibre, Paper, Lumber.

MONTREAL - CANADA

News Paper, Hanging Paper, Wrapping Paper, Building Paper,  
Celebrated "Impervious" Spruce Sheathing and Sulphite Fibre for all  
kinds of Paper.

## THE CANADA COATING MILLS, Ltd. GEORGETOWN, ONT.



Manufacturers of  
SURFACE COATED BOOK and LITHOGRAPHIC  
PAPERS COATED CARDBOARD and COATED  
BOXBOARDS of every description.

### "Chalk White" Coated Book Paper.

The best and whitest coated paper sold.

**ALL REGULAR SIZES AND WEIGHTS IN STOCK.**

Our Art Litho Cover Paper is stocked in four tints,  
2 sizes. 20x25 and 21½x28½. Samples gladly sent.

MONTREAL  
TORONTO

**CANADA PAPER CO.**  
LIMITED

WINDSOR  
MILLS, P.O.

# DIRECTORY

of

## Civil and Chemical Engineers

### T. PRINGLE & SON, Limited

Engineers and Architects

Plans and Specifications for Pulp and Paper Mills, Power Plants and other Industrial Works.

Coristine Bldg., Montreal. Continental Life Bldg., Toronto.

Bell Tel.: M. 3890.

Tel.: M. 5917.

### R. S. LEA, and H. S. FERGUSON, ENGINEERS

Pulp, Paper and Chemical Fibre Mills. Water Power Development and Transmission. Steam Power Plants. Telephone Long Distance Up, 751. 405 DORCHESTER ST. West, MONTREAL

### Arthur D. Little Inc.

— LABORATORY OF —  
ENGINEERING CHEMISTRY

93 BROAD ST., BOSTON, - MASS.

Our staff includes experts in Papermaking Chemistry —Sulphite Mill Practice—Fuel Engineering.

### GEORGE F. HARDY, M. AM. SOC., M. E. M. CAN. SOC. C. E. Consulting Engineer.

Paper, Pulp and Fibre Mills, Examination of Mill Properties, Water Power Developments.

Mutual Reserve Building, - 309 Broadway,  
NEW YORK.

CHARLES E. EATON, M. Am. Soc., M. E. JAMES P. BROWNELL, C. E.

### EATON & BROWNELL, Consulting Engineers and Architects.

Paper, Pulp and Fiber Mills, Water, Steam and Electric Power Development, Examination of Properties, Consultation Reports.

SMITH BLDG. WATERTOWN, N. Y.

### F. W. DEAN, Mill Engineer and Architect (Formerly of Dean & Main)

Exchange Building 53 State Street,  
BOSTON, Mass.

Paper and Pulp Mills. Steam, Hydraulic and Electrical Developments. Examinations and Reports of Projects.

### T. LINSEY CROSSLEY

*Engineering Chemist*

PULP AND PAPER  
TECHNOLOGY

318 Lagauchetiere St., W., Montreal

### FOREST ENGINEERS

FOREST SURVEYS LOGGING MAPS

WATER POWER TIMBER ESTIMATES WATER STORAGE

CLARK, LYFORD & STERLING  
1331 Real Estate Trust Bldg., Philadelphia  
CLARK & LYFORD LYFORD, CLARK & LYFORD  
403 Crown Bldg. 26 Board of Trade Bldg.  
Vancouver. Montreal.

### FRED. C. ANDERSON *Mill Engineer*

20 years practical experience in paper, ground wood and chemical pulp making. Steam Hydraulic and Electrical development, Examinations and Reports on both old properties and new projects.

9-10 Strickland Bldg., CARTHAGE, N. Y.

ENGINEERS SHOULD WRITE  
THE PUBLISHERS FOR RATE  
OF CARDS ON THIS PAGE.



**PULP  
PAPER  
POWER** JOSEPH H. WALLACE & CO.  
INDUSTRIAL ENGINEERS.  
TEMPLE COURT BLDG. NEW YORK.  
SALISBURY HOUSE, LONDON, E.C.  
CABLES, TRIPLEX, N. Y., TRIPLEXIS, LONDON.

**C. B. PRIDE**

**MILL ARCHITECT & ENGINEER**  
**PAPER, FIBER, AND PULP MILLS,**  
**— WATER & STEAM POWER DEVELOPMENT**  
 25 YEARS SUCCESSFUL OPERATIONS  
**SPOKANE, WASH OFFICES APPLETON, WIS.**

<p><b>HERBERT S. KIMBALL</b>                  M. Am. Soc. C.E.      <b>CONSULTING ENGINEERS</b>  <b>Metropolitan Building</b>      -      <b>QUEBEC CITY</b>                  PULP AND PAPER MILLS                  Design and Reports                  Steam and Water Power Development</p>	<p><b>R. O. SWEEZEY</b>                  A.M. Can. Soc. C.E.                  SCIENTIFIC FORESTRY                  Limit Cruising                  Water Storage</p>
---	--

Power, Lighting, Heating, Ventilating and Drying.—Complete New Plants, Improvement of Old Plants;  
 Plans, Specifications, Contracts, Estimates, Tests, Appraisals, Inspections and Reports.—Pulp, Paper,  
 Box Board and Coating Mills.

<p>Lowest Possible Operating Cost.</p>	<p><b>H. B. PRATHER,</b>  <b>CONSULTING ENGINEER,</b>                  ROCKFELLER BLDG., CLEVELAND, O.</p>	<p>Guaranteed Results.</p>
--	--	--------------------------------

**HUGH R. BLETHEN**

**21 PARK ROW, - - - NEW YORK, N.Y.**

Traveling Cranes - Overhead Tramways - Trolleys and Chain  
 Hoists for Paper and Pulp Mills - Power Houses.

**Stebbins Engineering & Mfg. Co.**  
**WATERTOWN, N.Y.**

MANUFACTURERS OF  
 STEBBINS' ACID SYSTEMS, SULPHUR BURNER  
 DIGESTER LININGS, RECLAIMERS, ETC.

<p>Engineering Department under Mr. T. L. TOMLINES</p>	<p>Plans, Estimates and Specifications for Paper, Pulp and Fibre Mills, Water Power and Hydro-Electric Developments</p>
--	---

# LEUNIG PAPER SCALES

Showing correctly at a glance, by weighing a single sheet, the weight of a ream of Paper of any size, containing either 480, 500, or 516 sheets.

Can also be made to indicate in addition to the English weight, the weight in Kilogrammes.

Illustrated Price List on Application.



$\frac{1}{2}$  to 80 lbs.

**Price,**  
**Ten Dollars**  
F.O.B., London

$\frac{1}{2}$  to 120 lbs.

**Price,**  
**Fourteen Dollars**  
F.O.B., London

Illustrated Price List on Application.

**Alfred H. Mardon** 150 Shaftesbury Ave. **London, Eng.**

# PULP PRESSES

AND ACCESSORIES

**CANADIAN BOOMER & BOSCHERT PRESS Co., Ltd.**

18 TANSLEY STREET, MONTREAL

"LACHUTE FELTS" Bell Tel. No. 23

**The Hamelin & Ayers Co., Limited**

LACHUTE MILLS, P.Q.

MANUFACTURERS OF EVERY DESCRIPTION OF

**FELTS** FOR PAPER AND PULP MILLS

"The Best are the Cheapest."

**BARKER  
CHIPPER  
PAPER-CUTTER**

**MACHINE** *Of Every*  
**KNIVES** *Description*

**THE PETER HAY KNIFE CO., LIMITED, GALT, ONT.**

**The PULP & PAPER TRADING CO.**

TEMPLE COURT BUILDING, NEW YORK CITY.  
DEALERS IN

**Paper and Pulp of All Kinds.**

Prices and Samples on Application.

REGISTERED



JOHN KNIGHT, Pres. C. K. WILLIAMS, Treas. C. H. KNIGHT, Sec.

**Paper-Makers Chemical Co.**

FROM MINE TO MILL

**ENGLISH CHINA CLAYS  
MANUFACTURERS**

**Excelsior Felt Cleaner**

GBB Brand China Clay is  
a natural pure white, no artificial tinting  
Unsurpassed for  
coating, bleaching, or fine papers.

Superior Rosin Size  
Superior Satin White

**EASTON, PA., U.S.A.**

# **The Union Sulphur Company**

**Producers of the Highest Grade Brimstone on the Market**

Absolutely free from Arsenic, Selenium or Tellurium

**The Largest Sulphur Mine in the World**

**CALCASIEU PARISH, - LOUISIANA**

**Main Offices : Whitehall Bldg., 17 Battery Place**

**NEW YORK**

**WE GUARANTEE OUR SIZINGS TO BE ABSOLUTELY CLEAN  
OUR VERA PAPER SIZE**

is purest, strongest and highest free rosin size made. We can furnish you with an ideal rosin size and patented apparatus to use same.

**OUR VERA MILL SIZE**

is the best soluble paper makers' rosin size made. Ready to use in cold or warm water in the ordinary way without apparatus. Gives better satisfaction and is more economical than mill made size.

Our sizings are cleaned by our new patented process, and we guarantee this size to be absolutely clean, without the least speck of impurity in the same, preventing thereby black specks in the paper. We are shipping our size in barrels or tank-cars.

**VERA CHEMICAL COMPANY**

Main Office and Western Factory  
NORTH MILWAUKEE, WIS.

Eastern Factory  
STONEHAM, MASS.

**J. R. Walker & Co.** Importers and Packers of **GRADED RAGS, PAPER STOCK  
ROPE BAGGING, ETC.**

WAREHOUSE, 35 COMMON ST., MONTREAL.

Also Manufacturers of Roofing and Building Papers. Leatherboard and Friction Board

Mills at Sault au Recollet, P.Q.

**ATTERBURY BROTHERS, Incorporated.**

*Importers and Exporters.*

**Wood Pulp,** FOREIGN AND DOMESTIC **Rags AND Paper Stock**

Potter Building, 145 Nassau Street, New York City.

Cable address "AFFECTIVE," New York.

**CHURCHILL & SIM**

29 CLEMENTS LANE, LONDON, E.C.

And at Manchester

**WOOD PULP AGENTS**

Telegraphic Address:—  
"CHURCHILL, LONDON."

A.B.C. CODE  
5th Edition

# A. WERTHEIM & Co.

## HAMBURG

---

---

IMPORT AND EXPORT ALL KINDS OF

***Sulphite,  
Soda and  
Mechanical***

# WOOD PULPS

---

---

**OFFICES AT:**

CHRISTIANIA (Norway) .. Kirkegaden No. 20.  
GOTHENBURG (Sweden) .. Lilla Kyrkogatan No. 20.  
MANCHESTER .. .. Guardian Buildings (opposite Exchange).  
LONDON .. .. . 77a Queen Victoria Street, E.C.  
PARIS .. .. . Rue de Londres No. 29.  
ANGOULEME (France) .. 43 Rue Louis Desbrandes.  
LYONS .. .. . 54 Cours Gambetta.  
MILAN .. .. . 24 Via Solferino  
TOLOSA (Spain) .. .. 18 Calle San Francisco.  
NEW YORK .. .. . 99 Nassau Street.  
ST. PETERSBURG .. .. Little Podjascheskaja House, 4, Qu. 16.

---

---

***Telegraphic Address:***

**“WERTHEMO, HAMBURG.”**



# WATEROUS Pulpmill and Woodroom Specialties

**We can furnish at Reasonable Prices—**

**RUBBER  
DIAPHRAMS**

Write us for prices and dates of shipment on high grade Rubber Diaphragms for Flat Screens. *In any width and any length.* Diaphragms 4-ply, 5-16 in. thick, built of selected rubber and high-grade duck only. We have supplied the largest mills in Canada.

**CYLINDER  
MOULDS**

Waterous Brass Cylinder Moulds are made in practically all sizes up to 48 in. diameter, any length, covered by a special process. Moulds are finished to perfect cylinder surface. Wire cloths are *sewn* on, not soldered. For a mould that will not loosen under wear and will remain tight until worn out, specify "Waterous."

**TRUEING  
DEVICES**

A true stone saves sliver waste, a sharp stone increases production. Our new Trueing Device is unique,—*it follows the stone.* For steadiness and range of adjustment it has no equal. Built in sizes for 24 in. and 32 in. Grinders. Place one in your mill and produce uniform pulp.

**GRINDING  
BURRS**

When your present Grinding Burrs are worn out, replace them by "Waterous" Tool Steel Burrs—they will keep your Trueing Device up to its work. Cut and furnished in sizes to suit any requirements.

**MAPLE  
PRESS  
ROLLS**

In any size up to 84 in. x 20 in., of selected Red Maple, turned and finished to absolutely true surface and perfect balance. Cast iron end gudgeons fastened together by bolts extending completely through roll furnished as part of the roll. These gudgeons are turned down to any bearing diameter. We have a stock of seasoned logs on hand—your roll will be turned to order.

WRITE US.

**The Waterous Engine Works Co., Ltd.**  
BRANTFORD, CANADA

**Geo. Christie Ltd.** - - **Glasgow  
Scotland**

## **FOURDRINIER MACHINE WIRES**

Unequalled for Strength, Smoothness and Long Life

## **CYLINDER COVERS**

**Canadian Agent :**

**J. A. Taylor, 22 St. Francois Xavier St., Montreal**

## **CANADIAN TALC FILLER**

**GEO. H. GILLESPIE COMPANY**

**MADOC - - - ONTARIO**

*The only Manufacturers of Paper Filler in Canada.*

Our Filler is used in Canada, United States, England, Germany,  
Austria, Holland, Russia and Scandinavia.

## **AMBURSEN HYDRAULIC CONSTRUCTION CO.,**

**OF CANADA, LIMITED,**

**405 Dorchester St. W. - Montreal.**

(Associated with the Ambursen Hydraulic Construction Co., of Boston, Mass.)



### **Concrete Steel Dam**

OF THE

**MISSISQUOI PULP CO.,**

**Sheldon Springs, Vt.**

Mid-channel, height 40 feet  
Total length 270 feet (only  
180 feet shows in the pic-  
ture, the remainder being  
concealed at the left.)

Dam specially designed to  
withstand heavy ice gorges.

Factors of safety are calcu-  
lated for a 12-foot flood.

**IF YOU HAVE A DAM TO BUILD, WRITE US NOW.**

Every Grade of Waste for  
Paper Making.

# R. HOUGH,

LONDON, England.

Agent for Canada and U. S.,

**THE J. CHRISTIE CO.**

5 King St. West, TORONTO, Canada.

STEAM PUMPS

CONDENSERS

VACUUM PUMPS

TRIPLEX POWER PUMPS

CENTRIFUGAL PUMPS

The Smart-Turner  
Machine Co., Limited

HAMILTON

CANADA

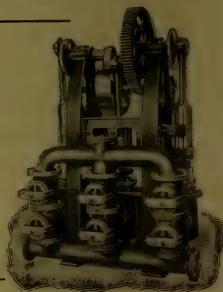

TRAVELING CRANES Electric or Hand



NORTHERN CRANE WORKS, LIMITED  
WALKERVILLE, ONT.

**HIGH  
TEST**

## BLEACHING POWDER

35/38%

(BRUNNER MOND & CO'S.)

THE STRONGEST AND THEREFORE THE CHEAPEST

WINN & HOLLAND, Limited, MONTREAL

# PULP AND PAPER MAGAZINE OF CANADA

VOL. 10 TORONTO, JUNE, 1912 No. 6

## PRINCIPAL CONTENTS

Report Paper for Canada  
Paper Prices  
Paper from Flax Straw  
Uses of Compressed Paper  
Waste Sulphite Liquors  
Measurements of Translucency in  
Paper  
The Atlantic Pulp Lease  
Spanish River Pulp and Paper Mill  
Opportunities for Paper Export to  
Austria  
Canada in String Materials  
Pulp and Paper News, New Inter-  
pretations, &c.



# THE JONASSEN PULP REFINER

For the Reclaiming of Ground  
Wood and Sulphite Screenings

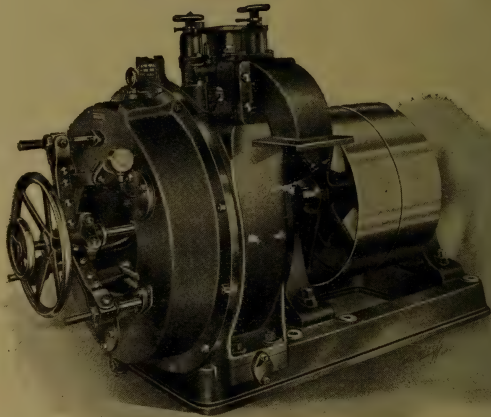

With this Refiner you save all your Ground Wood and Sulphite Tailings or Screenings, which now go to waste.

Capacity of Machine: From 8 to 10 tons of Screenings a day.

Power required to operate same: 20 horse power.

Write us for prices and further information.

## Rice Barton and Fales Machine and Iron Co.

WORCESTER, MASSACHUSETTS, U.S.A.



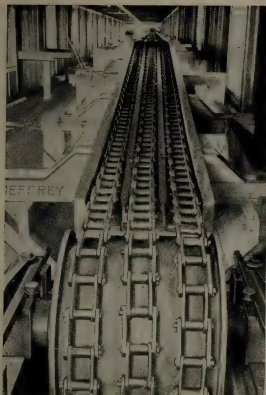

## Jeffrey Conveyers

for Pulp and Paper Mills reduce the cost and facilitate the handling of materials

Illustration shows a Jeffrey Chain Conveyor (200 ft. between centers) for handling pulp wood at the plant of the Anglo-Newfoundland Development Co.

Jeffrey Cable Conveyers are also used very extensively for storing, stacking and reclaiming pulp wood. They insure a maximum of storage at a minimum outlay.

Request our Catalog No. 57-B

## JEFFREY MANUFACTURING CO.

Canadian Works and Main Office, Montreal  
Winnipeg Representatives, - - N. J. Dinneen & Co.

E. J. WELCH, *President and Managing Director*  
HENRY W. S. DOWNS, *Superintendent*

EMMONS CROCKER, *Vice-President*  
A. S. MORSE, *Secretary and Treasurer*

## SCREEN PLATES



The "Union" Bronze (best phosphorized cast metal) Plates for Sulphite Mills. The Standard Rolled Brass Plates. The "Union" Cast Metal Suction Plates.

We carry a large stock of blanks of the various sizes in both metals and can fill all orders promptly.

Old plates reclosed and recut by our process are practically as good as new and give better results than by any other process

**Union Screen Plate Co. of Canada,  
Limited**

**FACTORY: LENNOXVILLE, QUEBEC.**

**OFFICES: Lennoxville, Quebec, and Fitchburg, Massachusetts, U. S. A.**

# Glens Falls Machine Works

GLENS FALLS, N.Y.



Sole Manufacturers of  
**Tromblee & Paull Rotary Sulphur Burner**

**The Moore Rotary Screen**

**The Reynolds Screen**

Also Manufacture

**Cedar Point Foundry Grinders**

**Improved Standard Grinders**

**Improved Wet Machines**

**Rotary Pumps, etc.**

Write for Particulars and Specifications—they are free.

# DODGE

**Transmission** —\*

—\* **Machinery**

— **High Grade Only** —

**Shafting, Hangers, Pulleys,  
 Friction Clutch Pulleys.**

## DODGE MANUFACTURING CO.

640 ST. PAUL ST. HAYMARKET SQUARE MONTREAL<sup>®</sup> LIMITED

Telegrams :  
"CALENDER, BURY"

Telephone :  
NUMBER 340

# Bentley & Jackson,

Limited

PAPER MAKERS'

.. ENGINEERS ..

BURY, - - ENGLAND

## *SPECIALITIES.*

MODERN HIGH SPEED NEWS PAPER  
MAKING MACHINES

SINGLE CYLINDER PAPER MAKING  
MACHINES

The NEW "*MARSHALL*" PATENT REFINING  
*ENGINE*, with separate adjustment to cones and discs,  
and our Patent Ball Thrust Bearing.

---

**APPLY FOR PRICES.**

---

## THE EDDY PAPER TESTER

Will register the breaking strength of paper in pounds per square inch—a recognized standard the world over.

**\$15.00 net**  
postpaid.

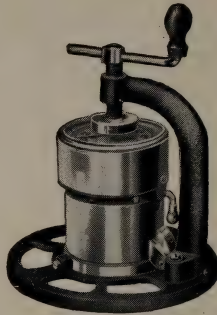

Is provided with an adjustment whereby the user can reset same, if necessary. Will do the work of higher priced machines and do it quicker. 6 inches high.

### DOBLER & MUDGE

BALTIMORE, MD., U.S.A.

— THE BEST —  
**JORDON ENGINE**  
IS BUILT BY THE

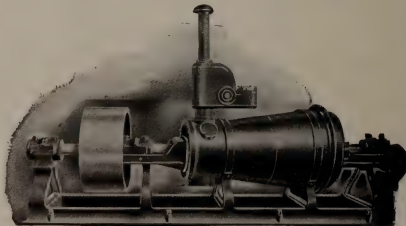

### APPLETON MACHINE CO.

APPLETON, WIS.

SEND FOR PARTICULARS

# New Centrifugal Screen

WITH HORIZONTAL SHAFT

PATENTED IN ALL PRINCIPAL COUNTRIES

**Smallest Power  
Highest Output**

**Direct Belt Drive  
Noiseless Working**

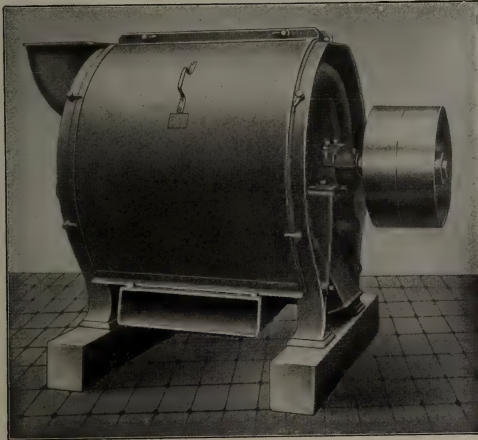

Equally well adapted for **GROUND WOOD** and **SULPHITE**

*I have now sold over 800 of these Screens*

FURTHER DETAILS, PROSPECTUS AND PRICES ON APPLICATION

**Complete Machinery for Wood Pulp, Paper and  
Sulphite Mills**

---

---

## J. M. VOITH

ENGINEERING WORKS AND FOUNDRIES

HEIDENHEIM ON BRENZ, WURTEMBERG, GERMANY

Branch Office for Canada and U.S.A., 1008 Fifth Ave. Bldg., New York  
Representative: H. F. STORRER, C.E.



J. MARX &amp; CO.

--

LONDON, E. C., ENGLAND

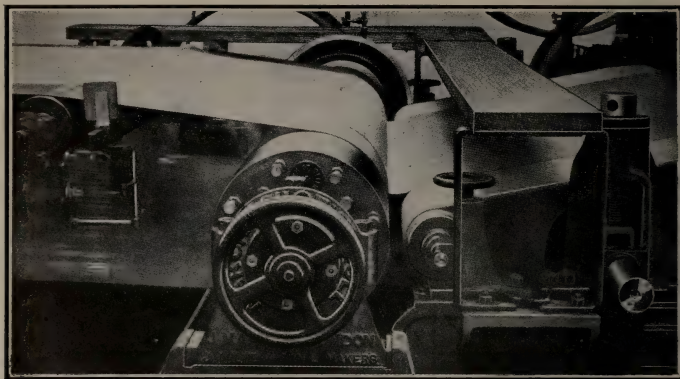

MARGALT SUCTION ROLL AT WORK

SPECIALTIES BASALT LAVA STONE BEATER ROLLS, DOUBLE BEATERS, STONE WET PRESS  
 ROLLS, BASALT LAVA PULP REFINERS FOR SCREENINGS

Canadian  
 Representative

Judson A. DeCew

Canadian Express  
 Building

Montreal

*The*

## Harmon Incline Screening System

Will give greatest capacity.

Will give cleaner stock.

Will save power.

Will save labor.

Does not require use of Rakers.

Write us for full descriptive Catalogue and testimonials from the best mills in the country.

# HARMON MACHINE COMPANY

WATERTOWN, N. Y., U. S. A.

OTTO WANDEL  
President

HERBERT H. MILLER  
Treasurer

# Wandel Screen Manufacturing Co.

WALPOLE, MASS., U.S.A.

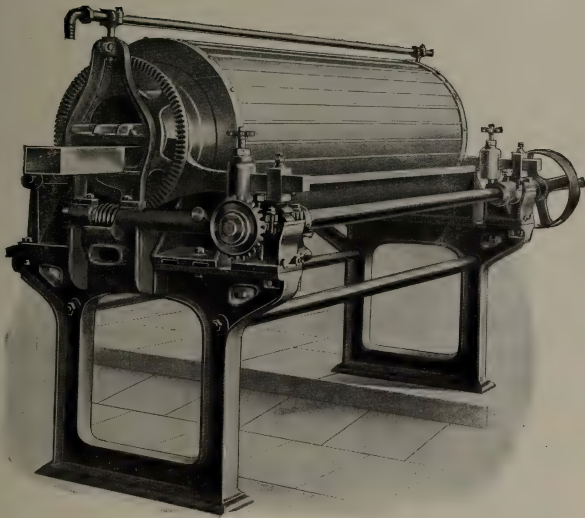

MANUFACTURERS OF THE

Quick Delivery.

Write for Catalogue  
and list of users.

We have no author-  
ized Agents in  
Canada.

# WANDEL ROTARY SCREEN

Over 200 Wandel  
Screens have  
been built and sold  
by us in the States  
within two years.

## SUPERIOR CONSTRUCTION

---

**THE SANDY HILL IRON AND BRASS WORKS, HUDSON FALLS, N.Y.**

---

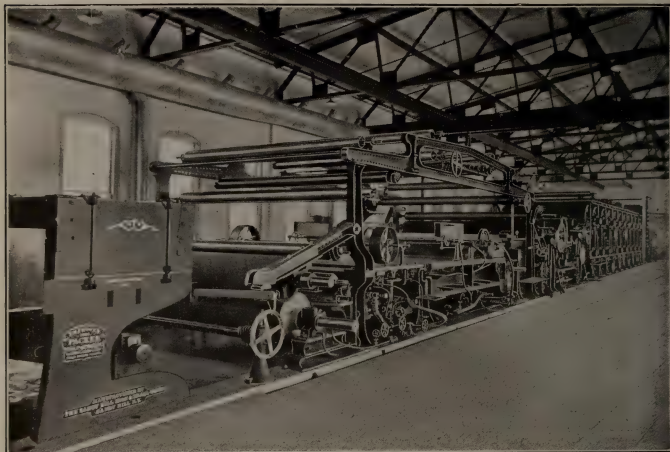

130" HARPER FOURDRINIER PAPER MACHINE

---

The ::

# West End Engine Works Co.

PAPERMAKERS'  
ENGINEERS

- - - EDINBURGH

Specialists in all kinds of  
Papermaking Machinery

Duplex, Angle and Square Cutters, Vickery's Laying Machines,  
Improved Umpherston Beaters, &c., &c.

PRICES ON APPLICATION

Telegrams : West End, Edinburgh

## The Improved “RUTH” Centrifugal Pulp Screen

To suit different conditions the “Ruth” is built as shown in the illustration, or with Steel Mitre Gears in a cast iron casing, independent of the footstep and running in oil, insuring long life of the gears.

It is also built **without gears**, using top pulley or motor drive. In this construction the screen plate sections can quickly be taken out and replaced through side doors.

All parts are easy of access, and no clogging of inlet or plates can take place.

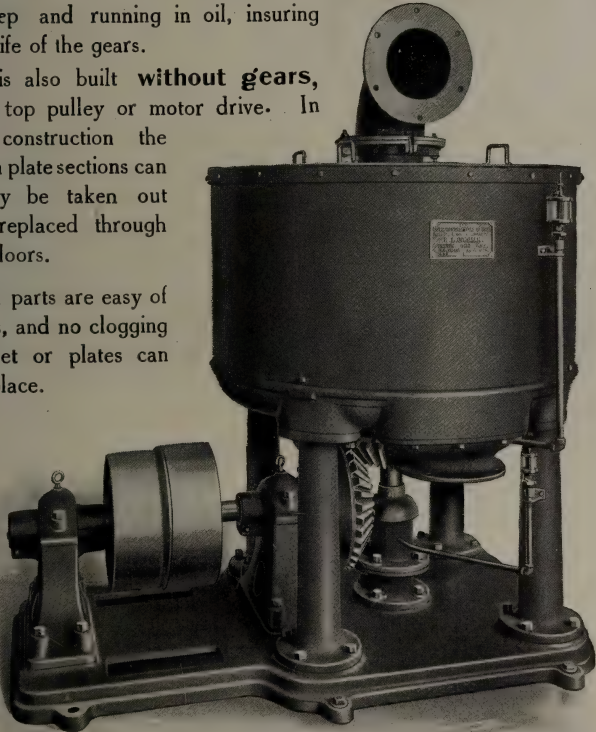

Other prominent features are—

- Simplicity of Construction.
- Small amount of power required.
- Great capacity and Low cost of maintenance.
- Lowest amount of fibre with the tailings.

In these respects this Screen is NOT surpassed by any other Screen in the market.

**P. P. Westbye, M.E., Peterborough, Canada**





---

---

**GARLAND PULP LOG**  
**Storage and Conveying Systems**

**Inventors of the CABLE CONVEYER**

*We have equipped 50 of the best American PULP and PAPER MILLS with CONVEYERS, LOG CUT OFF SAWS, SLASHERS, SPLITTERS, BAND MILLS and SPECIAL MACHINES*

*Send us your plans or ask for Representative to call on you*

---

---

**THE M. GARLAND COMPANY**

**Manufacturers of CONVEYING, SAW MILL  
and WOOD DESTRUCTIVE MACHINERY**

**BAY CITY - - - MICHIGAN, U.S.A.**



# Have You Heard the Facts About The Beloit Machines?

---

---

One Fourdrinier built for 500 feet has run 615 feet, and averages 550 feet and makes 72,000 lbs. of print in 23 hours, 110 inch trim.

Another, built for 350 feet, for manillas, is running 490 feet every day on print.

Two others, built for 250 feet on book, are now speeded up to 340 feet on book.

A cylinder machine built for 40 tons of strawboard has made 89 tons in 23 hours, and averages 76 tons per day, dryers are 116 inch face.

---

---

## Beloit Iron Works

BELOIT, WIS., U.S.A.

# DILLON MACHINE CO

BUILDERS OF

## PAPER MILL MACHINERY

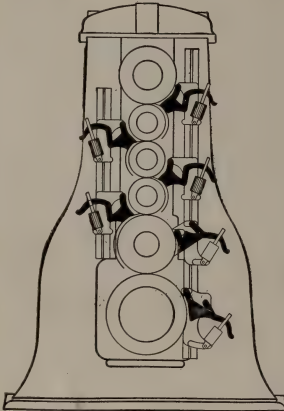

DILLON DOCTORS  
AND FEEDS

DILLON MACHINE CO.  
LAWRENCE MASS.

- Beating Engines
- Washing Engines
- Jordan's Three Sizes—  
Single, Double & Triple  
Stuff Pumps, with  
Dillon Patent Valve  
Seating
- Brannan Patent Paper  
Folders
- Horizontal and Vertical  
Stuff Chests
- Single and Double Paper  
Cutters
- Backstands
- Plates, Knives and Bars

DILLON  
PATENT  
DOCTORS  
AND FEEDS  
MADE IN  
CANADA  
BY THE  
SHERBROOKE  
IRON WORKS,  
SHERBROOKE, P.Q.

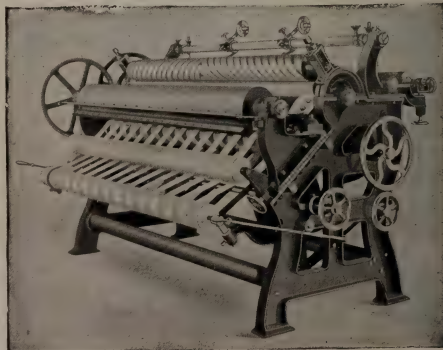

# LAWRENCE, MASS., U.S.A.

---

---

# The MOORE & WHITE CO.

PHILADELPHIA, PENN., U.S.A.



SEND FOR BULLETIN



Very severe tests have been made of this winder, but all of them have exceeded expectations. The photograph shows the winder attached to our standard slitter part which takes up less room than any other slitter and has several very good features. The winder can be used as a rewinder by attaching a back stand to carry the roll which is to be re-wound.

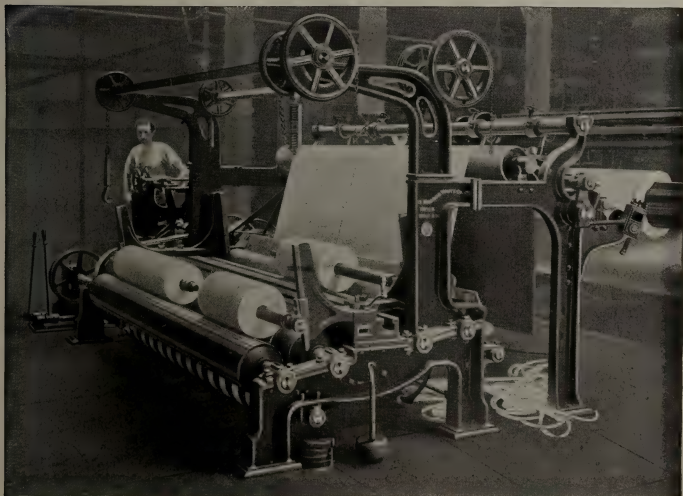

"M & W" Patented Four Drum Winder in operation

**SATURATING, COATING AND WATERPROOFING  
MACHINERY**

**SPEED CHANGES**

**FRICTION CLUTCHES**

---

---

# HOLYOKE MACHINE COMPANY

## HOLYOKE, MASS., U.S.A.

MANUFACTURERS OF

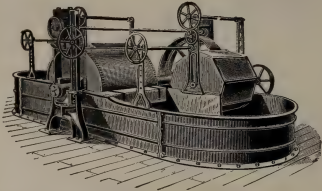

Washing and Beating Engines with  
Patent Double Hoist and Tubs of either  
wood or iron.

Hydraulic Pumps and Presses.

Rag Cutters and Rag Dusters.

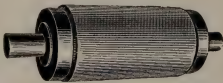

Cotton and Paper Rolls with Patent Fastenings.

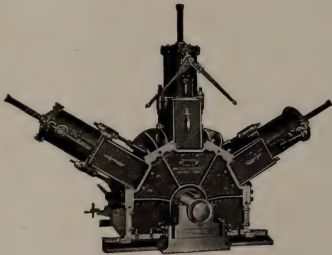

Patent Improved Wood Pulp Grinder.

Elevators, Rotary Fire Pumps and  
Friction Gearing.

Gears Accurately Spaced and Planed.

Shafting, Pulleys and Mill Work.

Machinery for Wood Pulp and  
Paper Mills.

Vertical and Horizontal Water  
Wheels with Flumes and  
all connections.

Wood Barkers, Wood Chippers  
and Wet Machines.

## Newest Designs

AND

## Highest Efficiency

Calenders. All kinds of Super  
Calenders, Friction Calenders  
and Platers.

Chilled Iron Rolls.

Special Machinery

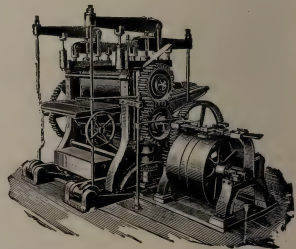

**Description and Estimates Furnished; also Gear List  
and Catalogs sent on application.**

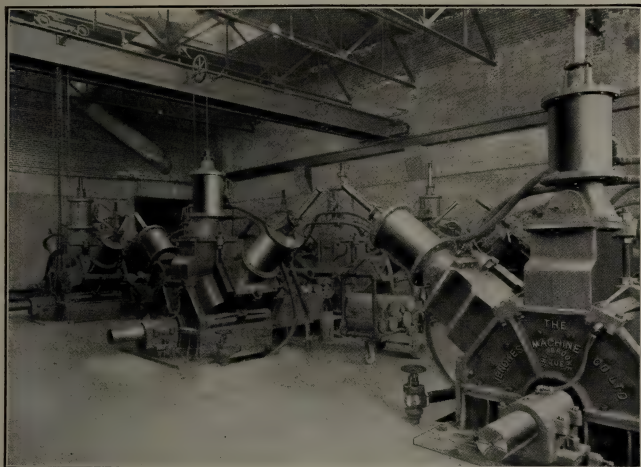

Our latest Model Pulpwood Grinder is of the three pocket hydraulic type, arranged for stones 54 inches diameter, and built in two sizes for 24-inch and 30-inch wood.

*Ask for Bulletins.*

## The Jenckes Machine Co., Ltd.

General Offices: Sherbrooke, Que.

Factories: Sherbrooke, Que., St. Catharines, Ont.

Sales Offices: Sherbrooke      Montreal      St. Catharines  
Porcupine      Cobalt      Rossland      Vancouver



---

---

# JAMES BERTRAM & SON, LIMITED

LEITH WALK

EDINBURGH - - - SCOTLAND

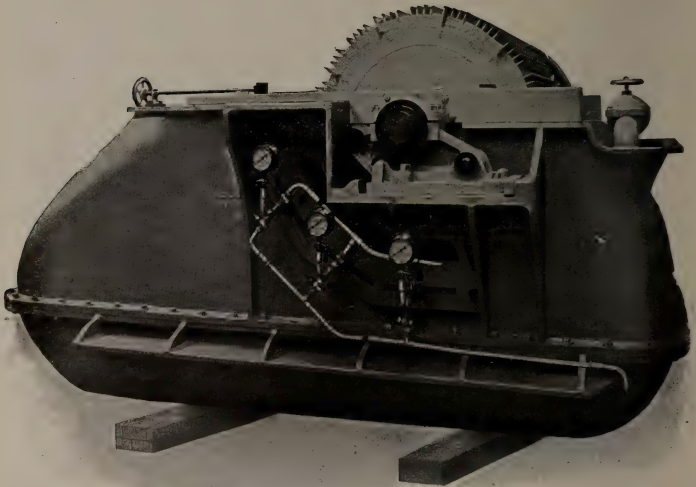

## Umpherston Beating Engine

Fitted with Three Patent Hydraulic Moving Plates

---

At work with great success, saving  $33\frac{1}{2}$  per cent. in TIME and POWER, and producing a superior Finished Sheet of Paper

---

*Full particulars on application*

*Telegrams—Bertram, Leith*

---

---

# PNEUMATIC

## Save-Alls, Pulp Thickeners and Filters

Remember that we make Special Pneumatic Machinery,  
not only for saving waste from white water but for  
thickening pulp and

*for filtering river water*

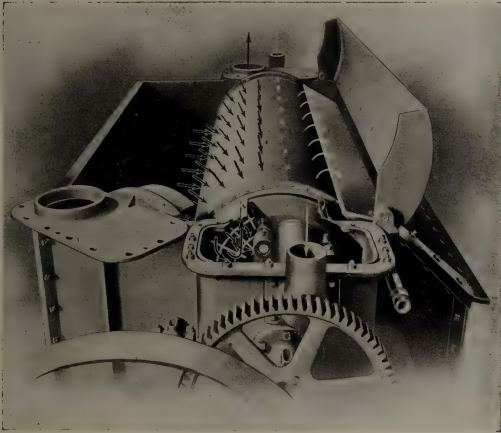

Pneumatic Action of the Save-All

The same pneumatic principle which has made our Pneumatic Save-alls and Pulp thickeners so successful has proved wonderfully effective in our Pneumatic Filter for river water. In this machine we employ an exceedingly fine cylinder-mold facing, through which several million gallons of water per 24 hours can be filtered clean. The clean filtering is due to the minute "mesh" of the covering and the continuous cleansing with air-blast and water-jet; the enormous capacity is due to the pneumatic action; the long life of this Filter is due to the absence of all mechanical wear upon the cylinder.

This machine is filtering clean even in cases where the river is exceptionally dirty because of saw mills located upstream.

*Send for particulars*

---

---

## Sherbrooke Machinery Company

LIMITED

SHERBROOKE

QUEBEC

## RENOLD PATENT SILENT CHAIN

### WHAT USERS THINK

Montreal, Feb. 8, 1909

Messrs. Jones & Glassco, Montreal

RE RENOLD SILENT CHAIN DRIVE.

GENTLEMEN,—In reply to your enquiry of Jan. 30th, I may say that the Renold Silent Chain Drives we have installed are giving every satisfaction.

Our first drive was installed to replace a 12 in. belt which was giving us trouble on account of short centres; this chain has run continuously for four years without the slightest trouble.

Our second drive was installed on a mixing machine doing heavy duty and which had previously broken up two sets of spur gearing; this chain has run over three years with no sign of wear yet.

Our third drive was installed on a calendaring machine after breaking two sets of helical gears, and this has been so successful that we are now installing two more similar drives.

I would be perfectly willing to make an appointment with any person genuinely interested and show him the drive in operation.

*The above comes from one of the largest manufacturers in Montreal and is signed by the Mechanical Superintendent. Up to the present (1912) these drives have not received repairs of any kind.*

So satisfactory has their experience been that they are ordering (for a new extension) Renold Chain Drives throughout, transmitting about 400 H.P.

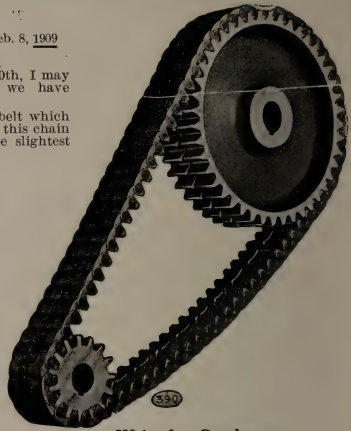

Write for Catalogue.

**JONES & GLASSCO, Sole Canadian Agents MONTREAL**

REGISTERED

# Lawrence Machine Co.

LAWRENCE . . . . . MASS.

— MANUFACTURERS OF —

## Lawrence Centrifugal Pumps

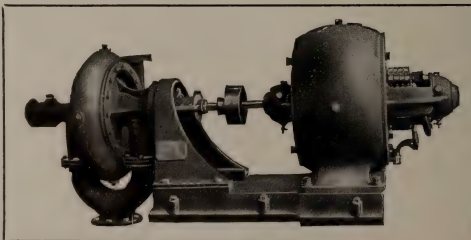

LET US FIGURE ON YOUR REQUIREMENTS

# THE LITTLE CHUTE PULP CO.

MILLS AT BUCHANAN, WIS.  
DAILY CAPACITY 50 TONS

LITTLE CHUTE, WIS.,

Mr. J. H. Taylor, V. P.

March 31, 1909.

McCartney National Bank,  
Green Bay, Wis.

Dear Sir:

Answering your inquiry of the 30th inst. with reference to New Barker Machine, made by the Green Bay Foundry & Machine Works of Green Bay, will say, we installed one of their barkers in our mill here on a 60 days' trial with guarantee as to its saving of wood and cordage with the old style of barkers. During the 60 days trial, we gave this barker a most thorough and severe test, covering the parts named in their guarantee, and have decided that the machine will do all that is claimed for it, in the saving of wood and in amount barked.

We feel sure that the machine will pay for itself in less than 6 months' time. On Spruce wood it has no equal that we know of.

We have bought the machine put in on trial and ordered one additional machine to be delivered as soon as possible, for our mill here, also ordered one machine for the Outagamie Paper Company at Kaukauna.

Mr. J. C. Kimberly and Mr. Peter Thom, after looking into the merits of the machine here, tell me, they have ordered one machine for their mill at Kimberly and two for Quinnesec.

Any further information you may want; we will be very glad to give it.

Very truly yours,

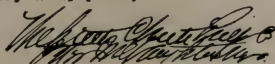

THE GREEN BAY BARKER CO.  
GREEN BAY, WIS.

CABLES, "PUMPS, BURY"

# WALMSLEY'S

We have Paper Making Machines 175 in. wide,

---

## Walmsley's Enclosed

FITTED WITH

Specially adapted for the

## DRIVING OF PAPER MACHINES

GIVING A VARIATION OF 10 to 1.

ESTIMATES GIVEN FOR

---

**CHARLES WA**  
**PAPERMAKERS'**

**ENGINEERS,**

Sole Agents for Canada : C. H. Johnson & Sons, Ltd



HIGH SPEED

# Papermaking Machines

making paper at over 600 feet per minute.

---

## STEAM ENGINES

FORCED LUBRICATION

OVER 280 OF THESE ENGINES SUPPLIED  
FOR PAPER MACHINE DRIVING ALONE.

COMPLETE PAPER MILL PLANT

---

# MSLEY & Co.,

LIMITED.

BURY,

*Near MANCHESTER.*

- St. Henry, Montreal, Quebec

# Wilson-Paterson Co'y



127 BOARD OF TRADE BLDG., MONTREAL.

Agents for the United Alkali Co. of England

## **OFFER TO THE TRADE:**

Caustic Soda 60° to 78° Soda Ash, Caustic Potash, Sal Soda, Silicate of Soda, China Clay, Rosin size and a full line of Rosins, direct shipment from the south.

**Contracts made for regular supplies.**

# PARSONS TRADING COMPANY

*Exporters of Paper to all Parts of the World*

WHITEHALL BLDG., 17 BATTERY PLACE, NEW YORK

BRANCH OFFICES AT

LONDON

SYDNEY

MELBOURNE

WELLINGTON

CAPE TOWN

BOMBAY

HAVANA

MEXICO, D.F.

BUENOS AIRES

**CORRESPONDENCE WITH MILLS SOLICITED**

# THE CARTHAGE CHIPPER

WILL INCREASE YOUR CHIPS. WILL  
DECREASE YOUR SAWDUST. By virtue  
of its Design and its Patent Feed Spout it takes a  
MINIMUM AMOUNT OF POWER.

---

Ask Anglo- Newfoundland Development Co.  
Ask Laurentide Pulp and Paper Company.  
Ask The Riordon Paper Company, Limited.

---

OR WRITE

**CARTHAGE MACHINE CO.**  
**CARTHAGE, N.Y.**

# Pulp and Paper Magazine of Canada

*A Magazine devoted to the interests of Canadian Pulp  
and Paper Manufacturers and the Paper Trade.*

SUBSCRIPTION PRICE; \$2.00 a year. Single Copies, 20 cents.

The pulp and Paper Magazine is published on the second Tuesday of each month. Changes of advertisements should be in the publishers' hands not later than the 1st of the month, and where proofs are required, four days earlier. Cuts should be sent by mail, not by express.

PUBLISHERS:

BIGGAR-WILSON, LIMITED, : Confederation Life Building, Toronto, Canada

## *Esparto Paper for Canada*

The position of Canada as one of the world's greatest sources of paper from wood pulp should be well assured by her possession of such vast stores of the raw material. But this very advantage should lead Canadian manufacturers to investigate and utilize other raw materials in order to give the industry completeness, for after all wood pulp alone will not produce every variety of paper needed in the highly specialized industries of the time.

We are indebted to Mr. Annandale, of Scotland, for calling our attention to a new opportunity Canadian paper makers have of introducing esparto as an element to give greater variety and improved quality to the better grades of paper.

Esparto is a grass native to both coasts of the Mediterranean, but growing more abundantly along the north African shore in Algeria, Tripoli, Tunis, Morocco, etc. It grows in tufts in sandy situations and is apparently one of Nature's first or second lines of defense against the assaults of the

desert sand. It is a wiry grass, three or four feet high, of very tough texture, and has been used for an indefinite time for making ropes, baskets, mats, sandals, etc. It was introduced into the paper trade by the French as a substitute for linen rags, but it was not adopted in England till 1857. It has not found its way to the United States or Canada in any appreciable quantity, for two reasons. The first is that as it takes about two tons of the straw to make a ton of pulp, the cost of freight stands against its common use as a material to be imported for pulp. The second is that it has not been possible heretofore to obtain the material here even in the form of ready-made pulp because the British mills import the straw not to develop an export trade in pulp, but to convert it into paper in their own mills, where it is mixed with wood pulp and other pulps according to the special character of paper to be made. In the present condition of the industry in Europe, France is the only country which exports esparto in the form of pulp, and having to a

large extent a monopoly of the industry the French manufacturers fix the price at about £20 sterling per ton, and pulp at \$100 a ton is too dear to be largely utilized in American or indeed in most European paper-making countries. The Italian mills appreciate esparto pulp, but object to paying £20 a ton, when, as they claim, they can make a product of equal quality, or better, on the English methods at £12 a ton; and now that Italy herself has a North African possession in Tripoli, this ambition is more keenly awakened, and Mr. Anandale has been commissioned by certain paper-makers to lay out works in Italy for the manufacture of esparto pulp as well as esparto paper for export.

By making an arrangement between Canada and Italy for the interchange of Canadian wood pulp and Italian esparto pulp, both countries can be exceptionally benefited, Italian mills being able to cheapen their newsprint and many Canadian mills being able to produce a class of paper heretofore imported from Great Britain, Germany and other countries.

Esparto is especially valuable in the manufacture of high-grade book, lithographing and bond and writing papers. In the making of papers for artistic illustrations esparto gives a sheet which combines a lovely surface with softness, flexibility and strength—all qualities of great importance. It is perfectly clear that if such qualities can be imparted to paper at a modest price for the pulp, the Canadian mills, already in the happy possession of cheap raw materials for all classes of wood-pulp papers, would take on a new development which would place this country in the very front rank of paper-making nations. It would not be long before Canada would be exporting not only the newsprint which with pulp now forms the only large item of foreign trade in this line, but would create a growing export trade in those qualities which yield a larger profit

per ton of output, and which would give a new status to the Canadian paper industry.

One of the best known paper mill owners to whom this matter was submitted by a representative of the Pulp and Paper Magazine agreed as to the importance of the question, and as to the feasibility of introducing esparto paper into the Canadian trade under the conditions now developing in Italy.

We do not forget that under the Franco-Canadian trade convention the special terms that would be granted in pulp to Italy would have to be accorded to France, but this would be all the better for Canada, as it would give Canadian importers of esparto pulp an alternative market at competitive prices, while to get the benefit of the treaty France should admit Canadian pulp at the same preferential rates as Italy. There would be no customs difficulty in importing this class of pulp into Canada, as esparto pulp can be distinguished from wood pulp at sight.

---

### PAPER PRICES.

---

For several months past the market quotations for many kinds and grades of paper have been straining upward and the wonder is that prices have not been set at a higher standard long ago. Now, however, a general advance has to be faced. For newsprint, while prices are not yet actually much higher, it is difficult to place orders at current quotations for very far ahead in the future. Manilas, especially the better grades, are at least a quarter of a cent higher. Bags also have been advanced and the discounts shaded down, particularly for small lots. Some of the book and writing manufacturers have already withdrawn their lists, while other mills will raise their quotations as soon as present contracts expire, or when present stocks become exhausted.

The cause for these advances, or rather for the necessity for the same, is not far to seek. There has been a steadily increasing tendency in the price of practically every raw material which enters into the composition of paper. Ground wood is high-priced for reasons which we need not enter into again here; sulphite extremely high because, among other reasons, of the recent strike in Scandinavia. Rags and paper stock are high owing to the increased difficulty of collecting the same during such a hard winter as the one recently closed. In addition to all this, wages are higher, and in short, practically every item which goes to swell the expense account in manufacturing paper bulks larger. As we said before, the wonder is that a general advance has not come before.

### PAPER FROM FLAX STRAW.

Straw as a material for making newsprint is an old story; in fact, fifty years ago, we believe some Canadian newspapers were printed on this form of paper. Now a company has been informed in Ottawa to utilize the large quantities of flax and wheat straw which annually go to waste in this country, especially in the Prairie Provinces. A Dominion Government report recently issued is responsible for the statement made by W. J. Robinson, that a chemical process has been invented under which a fibre has been successfully manufactured in Ireland from flax straw grown in Canada into yarns and cloth, as good as the linen produced from the best Russian fibre, and that paper of good quality can also be made from it. The fact that Canada produces annually something like a million and a half tons of flax, capable of being converted, if the estimates be true, into 300,000 tons of fibre worth \$60,000,000, makes the discovery a very important one, if it be based upon correct data. This is a point, however, on which it is quite

possible to be sceptical, in view of the hopes which have been raised and fallen flat in analogous cases.

### USES OF COMPRESSED PAPER.

The uses of paper are becoming wider and more varied every year, and The Pulp and Paper Magazine has seized more than one opportunity to point out how manufacturers may reap a substantial reward by bringing various specialties made of paper to the attention of the public and catering to the demand which would be created.

One specialty which is really a whole department in itself comprises goods made of compressed paper.

In the past some difficulty has been found in making a material which was not either too porous or too brittle, or not sufficiently adhesive. We understand, however, that a process has been invented, and indeed already in operation in Germany, whereby almost every article which has heretofore been made of wood, and a good many other articles made of very diverse materials, such as tin, china, glass, and so forth, can be made of compressed paper. The product is said to be superior to wood, in that it does not split or warp, and to glass as it will save breakage, and superior to either in its smaller weight and consequent liability to lower freight charges. The inventors claim that compressed paper made by this process never varies and is impervious to cold or heat or damp; and state that pulleys formed of this material, even when used over a steam vat for years, show no effect from these conditions. As a material for making barrels or drums to contain chemicals, butter and many other products, compressed paper is a substance hard to beat.

In fact, however, this is only one of the many extensions of the use to which paper is ordinarily put, and, as



Canada is destined to be the greatest paper producer in the world, our manufacturers should seize the opportunity to turn their attention to special lines, in which frequently there is the largest percentage of profit.

#### EDITORIAL COMMENT.

The rule-of-thumb methods by which some of the Canadian mills are producing pulp for export will have to be replaced if Canadian ground pulp is to successfully compete with the Scandinavian product in foreign markets. Mr. Alex. Annandale, the Scottish paper-maker, who recently visited Canada, assures the Pulp and Paper Magazine that Canadian exports of pulp could be tripled in a short time if they would ship a cleaner article. The fact is that the adjoining market of the United States is at present too easy a proposition for good health to Canadian pulp exporters.

\* \* \*

The United States Senate is still engaged in jockeying with the ill-fated Canadian Reciprocity bill: this time, however, purely for home consumption. That body have hit upon a scheme for killing the entire Democratic tariff programme without forcing the President to veto the different tariff bills, by appending to each tariff bill as it comes up an amendment repealing the ineffective Canadian Reciprocity agreement and fixing a duty of \$2 per ton on paper against the whole world. This they believe to be so antagonistic to the ideas of all factions in the House as to ensure defeat for the entire proposal.

\* \* \*

The wall paper trade of Canada has developed largely in recent years and in some markets a considerable export trade has been done by firms such as Colin McArthur & Co. and Watson, Foster & Co., of Montreal. The variation of standard sizes is a difficulty in the development of this trade. The

Canadian standard roll is 16 yards long and 18 inches wide, but the usual English roll is 12 yards long and 21 inches wide, and in some of the Colonial markets such as South Africa, the English standard widths and lengths are insisted on. The machines would have to be adapted to both sizes if a regular export trade is to be cultivated by Canadian wall-paper manufacturers.

\* \* \*

The result of the Quebec elections, namely, the return to power of Sir Lomer Gouin by about the same majority as in the previous election, is gratifying to the large number of Canadians, apart from party politics, who believe in the conservation of Canadian resources. It is nearly two years since his Government passed legislation whereby the exportation of pulpwood cut from Crown lands, except in the form of pulp or paper was prohibited. The multiplication of new mills and the extension of old ones since the passage of that law would certainly appear to have proven its statesmanlike quality, and the most was made of the fact in the pre-election campaign. Sir Lomer Gouin is to be commended for the firm attitude he has adopted against both the open and the veiled hostility of various interests antagonistic to his conservation methods.

\* \* \*

The hearing of the appeal against the recent decision of the United States General Board of Appraisers against the contention of the importers of pulp and paper that those commodities should be admitted free into the United States from favored nations just as from Canada, has been postponed until late in the summer or until the fall. The object of postponing settlement in such an important matter is difficult to say, as there would appear to be nothing to be gained thereby, and such delays always prove detrimental to trade. Still, while the outcome will naturally prove of great interest to Canada,

this country has no voice in the matter, and so it behoves us to say little. It will, of course, be beneficial to the pulp and paper industry of Canada if the recent decision be upheld. If, however, the reverse be the case, we have enough faith in our manufacturers and in the substantial basis on which they stand to be sure they will continue plowing their furrow without a qualm.

#### FORESTRY IN THE ADIRONDACKS.

The American Forestry Association, on May 2nd and 3rd, successfully carried out a new plan of holding their quarterly meetings at points where interesting forestry work is being carried on, and of inviting friends of the cause to join with them on the inspection trip. The idea is one perhaps, which might be followed with advantage in this country. The party, which represented wide interests, spent a day in visiting the nurseries and plantations of the New York State Conservation Commission in the Adirondacks.

They then drove to a series of extensive plantations, established by the State from three to seven years ago. These plantations were of particular interest because they represent a complete series of experimental plantings by seed spot methods, direct seeding, and the use of nursery transplants, and also include a large variety of species. The broadcast sowing of white pine, for example, seems to promise ultimate success, although at present the stand is not as uniform as from planted trees. The seed spot method showed a great variation in results, due partly to damage by mice and squirrels. Even where good germination had been secured in the seed spots, one drawback appeared, in that a little group of seedlings had to be thinned out and the extras used for filling in blank spaces, which adds materially to the expense. Of the various species tried, Scotch pine, Norway spruce, and strangely enough, western yellow pine showed the best results, Douglas fir and Colorado blue spruce being almost a total failure. Near the seed spot planting an extensive flat, which, according to

local history, had been open land for probably over fifty years, although still showing evidences of an original stand of white pine, offered an interesting lesson as to the influence of soil on the growth of seedlings. This particular flat is of a sandy nature, probably underlaid with clay or hardpan, producing conditions so unfavorable to tree growth that, although the plantation had been once replanted, the trees were not in a vigorous condition, and were making very slow growth. The ultimate success in the planting of heath lands in Europe leads to the conclusion that the trees will eventually become established in this poor Adirondack land. On the slopes in the same region the growth of planted trees is very vigorous, and many of them show a height growth of one to two or more feet annually.

The action of the American Forestry Association in inaugurating educational trips of this kind is a distinct feature. The most striking lesson, particularly apparent to those who have followed forestry developments for ten years, is that in this comparatively short period the attitude of the lumbermen, State officials, and of the public generally is absolutely changed. Ten years ago, when the first planting was done by the State and the nursery work was started, the whole scheme was subject to more or less ridicule. Ten years later we find some of the largest lumbermen in the East accompanying an educational party of this kind and studying with the greatest interest the methods of nursery practice and planting in vogue. Not only this, but several companies have in the meantime inaugurated work upon their own lands, specific cases being the International Paper Company, which is planting at the rate of 500,000 trees a year; the Union Bag Company, which has also been setting out young forest trees extensively; and the Brooklyn Cooperage Company, which is planting about 100,000 trees per year.

W. G. Swezey, brother of R. O. Swezey, the well-known forestry engineer, of Quebec City, has now become associated with the latter in business, and has charge of some extensive forestry work on the St. Maurice River.

## Waste Sulphite Liquors

By A. B.

In The Pulp and Paper Magazine of February issue, there appeared a special article on "Waste Sulphite Liquors," which seemed to be a resumé of the uses to which this material might be put, and a statement of the relative values of same. Any information such as this is always of considerable public interest, but allowance must always be made for the individual viewpoint, and the writer begs to present a friendly criticism of some of the ideas expressed.

The general conclusion of the author signed "M," was that all methods of utilizing this waste had been found futile, with the exception of the manufacture of alcohol, the processes of which have been recently developed abroad. It is to be hoped, however, that this is not the only commercial use for this waste material, on account of the large quantity available, for it is hardly probable that the manufacture of alcohol alone will solve the problem for many mills. In the first place, there are many plants so located that they have continual trouble from municipal authorities, owing to the fact that the streams on which they are located are small and the waste liquors from the pulp mill are considered to be a public nuisance. Now, as this material at present is discharged into streams, it is in a slightly acid condition, and until this acid is neutralized the produce does not decompose and become disagreeable. As in many streams, there are certain quantities of the carbonates of lime, the probability is that the free sulphuric acid in this waste would combine with the calcium, and then the product might slowly decompose. The tendency, however, is for this material to resist decomposition as long as it contains the astringent character resembling tannins which it has as it comes from the mill. On the other hand, the product remaining and discharged into the stream after the small percentage of sugar is fermented and converted into alcohol, containing, as it does, the yeast residue, will be a much more disagreeable and decomposable product

than the actual waste. It is evident, therefore, that as a means of satisfactory disposal of this material from the standpoint of the community, the problem is not solved by the process of obtaining alcohol.

If there were sufficient market for this material as an extract to be used in tanning, it would be the more satisfactory method of utilizing it, because it would mean that only the very weak liquors would be discharged into the streams. That this material, when properly treated, has a recognized function in tanning is now well known, but its efficiency as against that of the actual tannins, such as quabrado, when compared with the relative cost of each, will prevent any very large consumption of this material for tanning.

In regard to the use of this material as a wood preservative, "M" does not seem to think that this would be a commercial project, his objection being that the sulphite waste is a soluble product, and will leach out of the wood. This argument, however, would be a strong one against the use of chloride of zinc as a wood preservative, and yet this product is used more largely than any other in the preservation of woody material. Creosote, on the other hand, at 10 cents per gallon, is the most expensive wood preservative in general use. If, therefore, by the use of waste sulphite liquor, and the astringent properties which it has in its natural condition, the amount of creosote oil required for wood preservation can be reduced, there would seem to be a very profitable field for this project in the wood-preserving industry. In fact, there are special applications of this process now being developed, which soon may be of economic importance.

The use of this waste liquor alone in the maintenance of wood offers great possibilities, on account of the alteration in character of the wood thus treated. Specimens of wood, when dried after impregnation with this material, are more highly lignified, harder in character, and

will take a much better finish. The treatment of cheap commercial woods in this way produces a class of material with very useful properties, and different in many respects from any other woody material. In the near future, this treated product will be on the market, and once the product is successfully introduced, a method will be established for utilizing practically all of the dissolved wood now discharged into the public waterways, and there are very few conditions under which it would not be a profitable enterprise.

When we consider the amount of wood lost in solution from the sulphite process, the advantage of reclaiming this and putting it back into higher grades of lumber would seem very reasonable, and if this method of utilizing it proved to be a success, it is quite apparent that any other process would be less profitable. It remains for commercial results to demonstrate what means will prove of greatest economic value.

#### PULPWOOD INDUSTRY IN NEW BRUNSWICK.

In the 51st annual report of the Surveyor-General of New Brunswick, he makes some interesting remarks on the supply of pulpwood in that province, as follows:—

“Steps were taken at the last session of the Legislature to enact a law to prohibit the exportation of pulpwood cut from our Crown Lands. In doing this we were following up the line of the Provinces of Ontario and Quebec in preserving this class of wood, with the object of manufacturing it into pulp within the boundaries of our own Province. It was thought that out of fairness to those from the neighboring republic who had invested in properties of this kind, a certain time should elapse before placing the principles of the bill into operation, and accordingly it was decided that pulpwood should be prohibited from exportation on existing licenses on and after the first of August, 1912. While it is true our water powers are small in extent in comparison to Ontario and Quebec, upon which depends so largely the successful manufacture of

pulp, still it was felt that the enactment of such legislation would be an incentive to utilize such water powers as we have, thus affording employment to a large class of our people in an industry derived solely from our natural resources. When it is considered that a cord of pulpwood loaded on the cars in this Province is sold at an average of \$5 a cord, the price of this same cord when manufactured into pulp would average at least treble that amount. To extend this argument further and manufacture this pulp into finer grades of paper, a huge industry would be the result. The prevailing opinion throughout the Dominion to-day is to preserve our natural resources, and so far as this Province is concerned there is no question more vital to our interests than that which relates to the pulpwood industry.

“The most serious aspect of the pulpwood problem is not in the prohibition of its export, nor in regard to the difference of its value when manufactured into pulp or paper, but in the cutting down of our young forests, which should be left to grow and mature and thus keep up the forest supply.

“There is no doubt that the price of pulpwood is a strong inducement for our wood land owners to ship the young growth and turn into money what is considered only idle capital; but such a decision in the end not only impoverishes the owner of the land, but lays waste the forest growth, provides fuel for fires in the slashings made, and injuriously affects the forest floor. We have much to learn from countries of the old land, Germany, France, Sweden, and even in our own mother country, in our forest management and the marketing of timber. Conditions in these countries are of course different from ours, but the same principles prevail as to forest cutting and the care of the forest from fires. In some of these countries a tree must be planted for every one cut down; the whole of the tree even to its branches, is marketed and large areas are annually set out with young trees in order to perpetuate the forest. The forest floor is cleared of all material of a combustible nature and such a degree of perfection is attained in fire ranging that



damage from this source is reduced to a minimum. In Great Britain a great movement has commenced under Government auspices to replant waste ground, and millions of pounds in money have been provided to carry out this project. In the United States the forest problem is now being grappled with as never before. Great national forests are now set apart under the care of trained foresters. The era of the land grafter has gone, and the cry has gone over all that mighty land to preserve the forests for the present as well as for future generations, and to save what is left of ruthless devastation by the hand of man and the ravages of fire.

"Is it then opportune for us to husband our forest resources, to pass wise laws to preserve them from destruction and to vote what moneys are sufficient to carry these laws into effect?"

#### BLEACHING OF KRAFT PULPS.

Pulps intended for kraft paper must be bleached otherwise than pulps for ordinary paper in which special demands as to strength are not made. The following method of bleaching kraft pulp is given by "Papier-Fabrikant": The wood was boiled according to the sulphate process with indirect heating at only 7 atoms, but for 4—5 hours in a tumbling boiler. The liquor was kept at below 9° Bé. Before being bleached the mass was run through the edge-runners whilst hot and moistened with 5 per cent. bleaching liquor. After the pulp had passed through the edge-runners and had been left for about twenty-four hours in the pulp chest it was diluted and pumped into the bleaching engine. After being thoroughly washed and thickened by means of the washing drum to about 10 per cent. the pulp was heated to 30° C. and then the bleaching liquor was added. Whereas, a pure white was obtained in the case of normally boiled pulp with 12 per cent. chloride of lime, for kraft pulp at least 18 per cent. was required. It was striking that the loss of pulp by bleaching was reduced from 8 to 4 per cent. in spite of the greater quantity of chloride of lime. The papers made in this manner had a fracture length of 7,000 to 8,000 metres.

#### INSECTS ATTACK PAPER.

The value of packing paper in hermetically sealed tins or other packages, when it is intended for distant consignees, is shown by a recent illustration furnished by Clayton Beadle and H. P. Stevens, the paper experts of London. The case related by them refers to paper shipped from Great Britain and leaving them in good condition. It was packed in thick cases; the paper itself was done up in packets, each packet being covered with lead foil. On arrival at its destination it was found that many of the packets were bored right through with holes of about 5mm. diameter, perfectly round as though an instrument had been used. On going into the matter it appeared that these holes, which passed from one packet to another, communicated with recesses in the wood of the packing cases. In one of these recesses an insect was found which was submitted to an authority and identified as being the *Syrex Gigas*, the giant-tailed wasp. A few years ago this insect was rare in Great Britain, but of late years it has been largely introduced in foreign timber and is now comparatively common. It is immensely destructive to pine forests, the larvae feeding in galleries in the growing wood. The apparatus in its tail are the piercing weapons (for pine bark) and the ovipositor. The specimen in question as received by us had lost its head and its long antennae. The only inference to be drawn from this is that this insect, or the larvae of this insect, were contained in the wood of the packing cases, and that the insect made its way through the packets of paper, the packets being brought in close contact with one another and being very solid, in the same way as it does by passing through timber. By such means an immense amount of damage can be done to consignments.

Samples and prices of newsprint paper as used by British journals have been forwarded by E. D. Arnaud, Canadian Trade Commissioner at Bristol, Eng., who states that there is bound to be a great opening for Canadian newspaper in that country.



## Measurements of Translucency in Paper

The Bureau of Chemistry of the United States Department of Chemistry has issued a report on the above subject by C. Frank Sammet, Assistant Chemist, Leather and Paper Laboratory.

That property of paper which permits light to pass through it is usually spoken of as transparency. Although this term cannot be concisely defined, it more commonly refers to the transmission of the greater portion of incident light through matter without scattering. Paper is of such a discontinuous nature that light in transmission is always more or less scattered. This characteristic is more definitely expressed by the word "translucency," which is, therefore, to be preferred to "transparency." "Opacity," the inability to transmit light, cannot properly be used to express the degree of translucency or transparency of paper.

Translucency is quite an important property of paper, especially of printing, envelope, pergamene, and so-called transparent papers. The first two classes should not be so translucent that printing or writing will show through sufficiently either to inconvenience or to tire the eye, while the latter kinds should be so nearly transparent that characters may be easily and quickly read through them. Many procedures have been suggested for the measurement of translucency, but few of them have proved to be of any practical significance, and, as a rule, they have given only comparative results. A numerical expression is desired which will be standard in the valuation of the translucency of papers as established by the normal eye.

The most satisfactory instrument heretofore proposed for this measurement is the grease spot photometer. This consists of two lights of equal intensity with a spot screen equidistant between them. The paper to be examined is placed between the screen and one of the lights. The latter is moved until the light falling upon the screen is the same from both sides. The ratio of the distances of the lights from the screen is an expression of the translucency of the paper (Bohm's method).

The instrument devised by Klemm, in which successive sheets of the paper are inserted until the light from a one-candle power Hefner burner is cut off, is totally unsuitable to express the translucency of paper when it is looked at rather than through. Serious inaccuracies arise with this instrument, due to difference in surface, color in the paper, the transmission of light through more than one sheet and across intervening air spaces, and the retention of color sense by the eye, any one of which produces wide variations, and in some instances a reversal of the sequence of translucency. It also gives inaccurate results on colored papers; and, furthermore, it measures the light transmitted through the paper once, while ordinarily that which has been transmitted to the eye after reflection from a surface underneath, is the light which it is desired to measure.

The procedure to be described is free from the foregoing objections, and for practical purposes determines any degree of translucency, in white as well as colored papers, in terms of a standard. When a paper is placed over a white surface the luminosity observed is composed of the light reflected from the surface of the paper plus that which is reflected from the surface underneath. When the paper is placed on a perfectly black surface the luminosity is that of the light reflected from the surface of the paper only as the transmitted light has been absorbed. The difference of the values which measure these two effects gives an expression for the light transmitted, and, therefore, for the translucency of the paper. These measurements may be obtained by means of the tint photometer, which is constructed and operated as follows:—

Two blocks of magnesium carbonate are used as a standard white background. A piece of black velvet is most satisfactory as a black or absorbing background. The rays of the sun diffused through tracing cloth or white paper evenly illuminate the white surface of the blocks. These are viewed in a mirror on reflection through two apertures, which are focused by a specially ground lens into a

fields. One aperture is controlled by a shutter operated by a lever that reads 100 when wide open and zero when closed on a scale divided into millimetres, whereby any degree of luminosity may be obtained. In order to counteract the confusing impression different kinds of surfaces may have on the eye, the light is passed through a series of revolving lenses, thus producing uniform fields. It would be rather difficult to match this luminosity of the fields of different tints, and to eliminate this effect the fields are viewed through a colored glass of some primary color. The luminosity observed is inappreciably affected thereby in the case of white papers, and the same is true with those of deep tints, if the measurements are made through a glass of the primary color representative of the predominating hue of the paper, red, green, and blue glasses have proved satisfactory.

After the fields are matched the black velvet background is placed over one block. The paper whose transparency is to be determined is then placed over both blocks. By operating the shutter the luminosity of the lighter field (due to the light reflected from the surface of the paper plus the transmitted light reflected from the surface of the block underneath) is reduced until it matches that of the field with the black velvet background, the luminosity of which is due to the light reflected from the surface of the paper only, as the transmitted light has been absorbed. Hence the value of the lowering of the reading (100—the reading observed) is a measure of the transmitted light reflected from the surface underneath; i.e., of the translucency of the paper. Care should be taken to match the fields before a reading is taken. The paper should be in immediate contact with the background. The colored glass used in the reading should be as near a pure primary color as possible. Check results can be obtained within one division of the scale.

The proposed method gives more satisfactory results than those previously suggested, especially in the case of colored papers, and is, perhaps, more convenient in manipulation. The result gives the

translucency usually sought, namely, the transmission of light through the paper and reflection from the surface underneath, while the other photometer methods indicate the direct transmission. No errors of sufficient magnitude to interfere with the sequence of translucency as established by the normal eye have been observed. The figures in the second column express the translucency of the paper as determined by the proposed procedure. They also express directly the percentage of incident light transmitted through the paper and reflected back through it by the standard white surface upon which it rests. The results obtained by the proposed method and by the Bohm method are given in the table. The readings are on papers which range, to the normal eye, from very translucent to almost opaque.

Determinations of the translucency of papers by the two methods:—

Kind of Paper	Order according to normal eye	Proposed method (100—reading)	
		Photometer method of Bohm* calculated by formula, $\frac{P}{100 - R}$	$\frac{100}{1 - R}$
Japanese press copy (white) . . . . .	1	66	34.5
Parchment (cream) . . . . .	2	58	33.5
Press copy (brown) . . . . .	3	55	49.5
Glazed onionskin (white) . . . . .	4	40	54.5
Typewriter (white) . . . . .	5	37	60.0
Bond (pink) . . . . .	6	32	65.5
Typewriter (white) . . . . .	7	28	64.5
Bond (orange) . . . . .	8	27	67.5
Filter (white) . . . . .	9	25	65.5
Bond (yellow) . . . . .	10	20	68.0
Bible (cream) . . . . .	11	18	68.0
Ledger (white) . . . . .	12	18	69.0
Do. . . . .	13	17	70.0
Writing, linen finish (blue) . . . . .	14	16	68.0
Laid envelope (white) . . . . .	15	14	69.5
Scratch pad (white) . . . . .	16	2	79.5

\*Loc. cit.

## The Abitibi Pulp Lease

It will be remembered that a year or so ago the Ontario Government called unsuccessfully for tenders for the Abitibi and Nipigon limits. Now tenders are to be again invited for the former under somewhat similar conditions, the chief change being that the lessees will not be compelled to manufacture all the pulpwood into paper on the limit, but may ship some pulp. What will be required, however, will be the establishment of a 100-ton pulp mill, at a cost of not less than half a million dollars, and an undertaking to erect a 100-ton paper mill.

The terms of the lease require the successful tender to employ 250 hands for ten months of each year. The half-million dollars for the mill must be expended within three years, \$100,000 the first year, \$200,000 the second year and the rest within the third year. The lessees will be entitled to cut pulp after expending \$100,000.

The tenderer must agree to erect, at the direction of the Government, a paper mill of 100 tons' capacity, and operate it continuously with an output of not less than 75 tons daily.

In addition to the bonus to be named in the tender the lessee will be required to pay 40 cents a cord for spruce and 20 cents a cord for other wood, "subject to increase by Order-in-Council."

The Minister of Lands, Forests and Mines retains the right to say in what parts of the limit, and in what manner the wood shall be cut. No wood cut on the limit can be exported. Failure to erect a mill within the time specified will entail the forfeiture of the bonus and the cancelling of the lease.

The successful tenderer will be entitled to obtain Iroquois and Couchiching Falls, on the Abitibi, with the right to hold and control them, as well as Lake Abitibi, for power purposes, subject to such conditions as the Minister of Lands, Forests and Mines may deem expedient. Plans and specifications for the storage and regulation of any of these waters must be approved, and the Crown reserves the right

to erect dams and maintain works for the storage of water for power purposes, to regulate and control the same and to charge the owners or lessees benefited thereby a fair and reasonable sum. The lease contains provision for the development of the water powers to the fullest extent, according to plans and specifications approved by the Hydro-Electric Commission.

In connection with the above, we have received from a correspondent of *The Pulp and Paper Magazine*, who has recently made an examination of the proposition and of the country surrounding Iroquois Falls, a letter in which he criticizes certain terms of the proposed lease.

While the property is an excellent one, he is doubtful whether any business men would undertake to carry out the cast-iron obligations which the Ontario Government attaches to the conditions of sale. In order, he says, to make the proposition even half attractive for immediate development the privileges would have to be given for the development of mills and water power. The purchase of limits or the high stumpage rates asked on Crown limits would act against the operation of these limits so long as there are so many farm lots from which pulpwood could be bought in the vicinity of Iroquois Falls, Cochrane, etc. The settler, glad to realize some cash, would sell his wood merely for what it cost him to make it, that is, he would give his wood for his wages cutting same.

Under these conditions a large pulp, or pulp and paper, mill could be operated for a long time in this vicinity, but in order to make the mill-owners secure against any combination of farm lot-owners, a Crown grant of limits should, our correspondent thinks, be included in the paper companies' assets, especially to be cut upon later on. These limits, however, a company starting in at the present time could not afford to buy and still make the proposition pay. In fact a pulp proposition alone is out of the question at

this point just now, for the freight rates between there and Toronto would just about eat up the profits. If finished into paper the product would allow a small profit but not if dividends had to be paid on the outlay for limits and the stern obligations imposed by the Ontario Government.

Of course, later on, when the price of pulp and paper rises and when freight rates may perhaps be more reasonable, the Iroquois Falls project may pay. Meantime, however, it seems that there are too many good propositions of this nature nearer the markets. If, however, the limits and water-power were given on condition that a certain output of pulp or paper be guaranteed, capitalists might look favorably on the scheme.

---

#### TEMPERATURE IN PAPER MAKING.

Machine paper making is far less dependent on the weather than paper making by hand. Nevertheless, it may be interesting briefly to describe the influence on the former.

Paper suspended in great heat during the summer, dries rapidly, contracts greatly, becomes creased, takes a non-uniform grain, and when pressed for a long time scarcely acquires the requisite degree of flatness. Paper made in winter becomes flat more readily. In summer, rags having a certain softness are used. The rough and coarse rags are stored as much as possible for winter.

Paper exposed to frost has only little consistency, dilates, however, becomes softer, and acquires a shining whiteness. The fibres of the suspended sheets are driven apart by the ice contained in them, and the paper thereby becomes very absorbent and supple. In this manner fine Swedish filter paper is still made at the present day. In order to utilize the advantages of the frost the old paper makers prepared as much half-stuff as possible in the late autumn, when, as a rule, the water level was higher. As soon as it froze one part was worked up and the other part was exposed in the open on hurdles to the frost. The half-stuff very soon became soft and white. It could be

preserved even until the summer by adding some lime as soon as appearances of fermentation became noticeable. In this manner beautiful paper was obtained from gray, coarse half-stuff, and in many mills "frost paper," much valued at one time, could be made throughout the year. This paper was soft and strong, had a velvet-like, homogeneous surface, and could be well sized and glazed.

The sheets were generally dried in the top storey of the mill, but in Dutch mills on the ground floor when too rapid drying was less to be feared. The man controlling the drying had to know exactly whether the Venetian blinds of the drying chamber had to be opened or closed during certain weather. The sizing preferably took place only in the spring or autumn. During hot weather the size dried too rapidly and did not uniformly penetrate the sheets; during cold weather the drying was too slow, and the size became yellow and flaked off. During cloudy, damp weather the size ran down on the paper. Animal size readily fermented in summer, and, therefore, had to be mixed with alum.

Influence of the temperature on the removal of water from pulp on the wire of the paper machine can be readily obviated by heating the pulp. Likewise, the influence of weather on manufacture can be prevented by fans or heating.

---

In a news item in the last issue respecting the Dominion Envelope Co., an error crept into the last sentence. The National Envelope Co. is a distinct organization, which is manufacturing a style of envelope similar to that made by the Dominion Co.

\* \* \*

M. J. O'Brien, of Renfrew, Ontario, the well-known Cobalt mine operator, contemplates building a large pulp mill, utilizing the water-power from Quinze Lake. He has, we understand, already acquired a large tract of pulpwood limits between Quinze and Expanse Lakes, and is urging the Temiskaming and Northern Ontario Railway to build an extension to this district, which, it is claimed, would also open up some good farming land, besides be a convenience for shipping ore from some of the mines.



## Spanish River Pulp and Paper Mills

*Noteworthy Gathering of Shareholders and Other Guests Witness Inauguration of a Splendid New Plant.*

Wednesday, the 16th of May, will long be a memorable day in the minds of the 300 or more guests of the Dominion Bond Co., Ltd., Toronto and Montreal, who were taken by special train to Espanola to see in operation with their own eyes the wonderfully complete plant of the Spanish River Pulp and Paper Mills, Ltd. The weather was fine, the machinery operated with exceptional smoothness for an initiation ceremony, and the visitors spent a very enjoyable time. For this, the untiring courtesy of Mr. Dean, of the Dominion Bond Co. and of the officers of the Spanish River Mills was largely responsible.

east to west, and the Canadian Northern along its east and north sides. Not only this, but several drivable streams and rivers, including the Spanish River, draining an area of about 3,500 square miles, the Vermilion River draining 1,500 square miles, and the Onaping River draining 1,000 square miles, make easy the work of bringing down the logs.

The solidity of the whole construction is well exemplified in the dam. This has a 60-foot head of water, and is made of concrete, connecting two high rocky projecting points on either side of the Spanish River. All the foundations of the



**General View of Spanish River Pulp and Paper Mills.**

The feature which first strikes the eye of the observer is the splendid natural location of the plant. In the first place, the Company's concession is probably the finest on the continent, comprising 6,000 square miles, and its net yield of spruce pulpwood is estimated on good authority to be no less, and probably more, than 4,000,000 cords, of jack pine suitable for the same purpose 8,000,000 cords, besides balsam, poplar, etc., and timber for general purposes. In other words, there is sufficient wood in sight to run a mill considerably larger than the present plant for something over a hundred years, during which time, of course, the natural course of re-growth would be sufficient to provide for continuance indefinitely. The C. P. R. runs through this concession from

buildings are laid in solid rock. The power development is 16,500 h.p., of which 10,500 h.p. is used in the pulp mill and 6,000 in the power-house.

On every hand are to be seen signs of the care which has been taken to lighten the labor of handling, which is such an important item in the economic operation of a pulp and paper plant.

As the pulpwood logs emerge from the booming ground above the dam, they come up an inclined cable to a 16-foot slasher, specially designed by the staff, are cut into two-foot lengths, and then automatically drop into a cable conveyor 60 feet high and 600 feet long. The storage capacity of the heap at the end of this conveyor is 40,000 cords of wood. The economy of this arrangement is evidenced



by the fact that the total cost of taking logs from the water, cutting and storing them is less than 15 cents per cord, as against an average cost, we suppose, in other plants of 75 cents.

From the storage pile the logs are conveyed to a room situated on the brink of the hill overlooking the pulp mill, where the rough knots and bark are removed by means of barking machines operated by an electric motor. The shavings and waste from the wood are mechanically

been practically eliminated, thus obviating to a large extent the heavy maintenance charges.

The screen room is very complete, and perhaps one of the most interesting features of the plant. The diluted pulp is conveyed by gravity through two sets of screens, passing thence in a steady flow to storage tanks in the machine room.

In the machine room there are eighteen 84-inch wet machines. The pulp flows in at one end of these in the consistency of



**Screen Room in the Pulp Mill, Spanish River.**

conveyed by blowers to the boiler house, while the barked wood is delivered to the grinder house by means of a short conveyor and a large gravity slide.

The grinder room is situated in the northern part of the main pulp mill. Twenty-four grinders are in use, driven by water-wheels. When the logs have been reduced to the consistency of pulp, this is conveyed to a large concrete tank by means of gravity. All the grinders and water-wheels are set upon heavy concrete and steel foundations, and vibration has

been practically eliminated, thus obviating to a large extent the heavy maintenance charges. These sheets are piled on iron trucks with wire mats between each sheet.

When the truck has been piled up to the height of several feet, it is rolled into one of the hydraulic presses. Gradually the ponderous weight is forced upward, a pressure amounting to 450 tons being applied. After the exertion of this extreme pressure 58 per cent. of the pulp is dry. A big percentage of transportation charges is in this way saved. The pulp is then

conveyed by means of an elevator to the upper level, where it is loaded directly into cars for shipment.

The pumping station contains two turbine water pumps, possessing a capacity of 6,000 gallons per minute, and used for supplying the entire paper plants with water. In addition are two turbine stock pumps, similar in capacity, used for pumping the ground woodpulp from the pulp mill on the lower level to the paper mill above. A booster pump is contained in the pumping station, electrically driven, which will be used for fire protection, and there is also a steam pump, with a capacity of 1,500 gallons per minute.

The buildings comprising the new paper mill are all designed in a fashion that is sure to reduce materially the cost of manufacture, and the internal fittings are

the two chests mentioned are electrically driven pumps, which pump the thick pulp to the beaters above, thus eliminating any handling by labor.

In another portion of the building are found round concrete tanks, two of which are used to put the paper stock into and from the beaters, the whole being carried thence to the paper machines. In the basement are two more pumps, used to handle the paper stock from the tanks to the Jordan engines. The eight beating engines are in two units, and each unit is driven separately by a three hundred h.p. motor. On the second storey are eight beaters, each of a capacity of one ton, and these are used to prepare the paper stock for the paper machines. These are erected in two separate units, thus any accident which may happen to one will

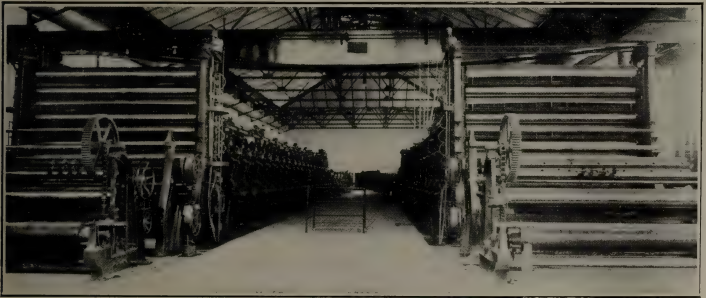

**The Paper Machine Room, Spanish River.**

modern and very complete. The filtration house has sufficient capacity to filter all the water to be used in both the pulp and paper mills. The water supply taken from the canal runs by gravity. A large freight elevator will be useful in the process of loading the Company's output into cars. A storage building has been provided for the chemical pulp, a portion of its basement to be used as a machine shop.

The building containing the beater room has in its basement two ground woodpulp slush chests, on top of which are placed machines to abstract the water from the pulp, and to discharge the thick pulp into the chest ready for the beaters. Between

only necessitate the closing down of four of them until repairs are made. The two large Jordan engines which are used to refine the paper stock after it has been prepared by the beaters are directly connected to electric motors.

The paper mill proper is 276 feet long by 82 feet wide. In the basement of this building are eight large suction pumps, two large stock pumps, and the necessary water pumps. To propel at variable speed the paper machines two six-hundred h.p. steam engines have been provided. The exhaust steam from these engines will be used to apply heat for the drying of the paper. In order to eliminate the handling of broken paper by labor, a beater has

been placed in the basement, and after the broken paper has been treated it will be pumped once more into the stock tanks. On the second storey are two Fourdrinier paper machines of the latest type, each one capable of manufacturing a sheet of newspaper 156 inches wide, and each with a capacity of 50 tons daily. At the north end of the machine room a gallery has been arranged, containing four pneumatic save-alls. All the water from the machines is pumped to these save-alls, and in this manner every particle of stock that the water contains is saved. The building in which the paper product is finished is 154 feet long and 92 feet wide. The upper storey is used to finish the rolls of paper, while the lower storey is designed exclusively for storage.

All the buildings connected with the paper plant are equipped with steel window frames, concrete window sills and steel lintels, with single and double glazing. The entire design of the buildings has in view the installing of two more paper machines at a later date, which, in view of the arrangements made, may be done with practically no additional capital expenditure in this respect. A steel water tank, 100 feet high, possessing a capacity of 50,000 gallons, has been erected, thus assuring the company in its operation a continuous supply of water pressure, as well as good sprinkling system in case of fire.

The following is a recapitulation of the chief items of the equipment:—

- 24 Pusey & Jones Grinders.
- 5 2,200 h.p. Holyoke Water Wheels.
- 7 Baker & Shevlin Centrifugal Screens.
- 14 Manson Centrifugal Screens.
- 12 Success Screens.
- 16 Jenckes Machine Co. Wet Machines.
- 8 Waterous Engine Works Beaters.
- 2 Jordans (Jones Co., Pittsfield, Mass.).
- 4 Sherbrooke Machinery Company Save-Alls.
- 2 164-inch Pusey & Jones Paper Machines.
- 2 600 h.p. Goldie & McCulloch Steam Engines.
- Robb Boilers.
- Murphy Stokers.
- Exeter Machine Works' Coal and Ash Handling Equipment.

Pumps furnished by Deane Steam Pump Co. and John MacDougall-Caledonian Iron Works, and Masson & Scott, London, England.

Motors and Generators by Canadian Westinghouse Co.

The pulp mill has a capacity of 140 tons of dry pulp per day, and the paper mill has a capacity of 110 tons of news print per day.

The requirements of this plant in the way of sulphite pulp are supplied by the mill of the Ontario Pulp and Paper Co., Sturgeon Falls, which is practically under the same management. About 60 tons daily of its own output of groundwood will be used in the paper plant, the remainder being shipped away, largely to west central states. The groundwood plant may be extended in the near future.

The following are the officers of the Spanish River Mills, Ltd.:—President, W. J. Sheppard, Waubashene; Vice-President and Managing Director, T. H. Watson, Toronto; Vice-President, G. P. Grant, Toronto, who is also President of the Dominion Bond Co.; Secretary, R. J. Ward, Toronto; Treasurer, R. A. Lyon; Sales Manager, E. V. Fox; General Superintendent, Jos. H. Slater, formerly of the International Paper Co. The new paper plant is in charge of F. H. Fielding, formerly with the Canada Paper Co., Windsor Mills, Que., while W. J. Hussey is Superintendent of the groundwood plant.

The company, in conjunction with the Ontario Pulp and Paper Co., has a fine suite of offices in the Royal Bank Building, Toronto. We should not forget to mention that at its head are broad-minded business men, who know the value of a contented, comfortable staff and working force. At Espanola they have already in existence a model town, where tasty-looking houses may be rented. There is also a particularly good hotel, under the company's control, where the rates are moderate and the accommodation more than ordinarily good. Altogether, the shareholders saw, on their visit last month, a property and surroundings which they might well be proud of.

The plant was designed by J. H. Wallace & Co., the well-known paper mill engineers of New York and London.

## Pulpwood Consumption in the United States

According to figures just compiled by the United States Forestry Bureau, there was, in 1910, an increase of about 2 1-3 per cent. in the consumption of pulpwood during that year. The 272 mills reporting used 4,094,300 cords, or an increase of 92,700 cords above the quantity used by 253 mills reporting in 1909. In 1910, one-fourth of the pulpwood used in the United States came from Canada. Twenty different kinds of wood were used in the manufacture of pulp, but two of these, spruce and hemlock, formed over 70 per cent. of the total quantity reported. The heaviest demand has fallen upon domestic spruce on account of its abundance, but the proportion which this wood forms of the total has been steadily decreasing. Spruce, domestic and imported, constituted 58 per cent. of all pulpwood consumed in 1910, compared with 60.5 per cent. in 1909, 64.5 per cent. in 1908, and 68.2 per cent. in 1907. The quantity of imported spruce used in 1910, 902,407 cords, was 134,075 cords greater than that in 1908, while it was 3,168 cords less than the quantity in 1907. Hemlock, though used to a greater extent in 1910 than in any previous year, shows little change in relative importance, the proportion which it formed of all pulpwood consumed being approximately 14 per cent. in every year except 1908, when it was 17 per cent.

Of poplar, 361,076 cords were consumed in 1910, or greater than that reported for any year except 1907. Imported poplar shows a rapid rate of increase, the gain since 1909 in consumption being 77 per cent.

The woods other than spruce, hemlock and poplar are at present of minor importance, as compared with the three leading woods in the industry, but as a result of the constantly increasing demand for paper, and the consequent heavy drain upon the most accessible sources of supply for spruce and hemlock, as well as some other economic causes, there is a tendency to use other species as far as practicable. The use of balsam as a pulpwood appears from the figures to have increased materially during the past few years, the re-

ported consumption of this wood forming 1.1 per cent. of the total of all woods in 1907, and 3.2 per cent. of that of 1910.

During 1910, in New York State, mills consumed 956,916 cords of wood for pulp material, which was 23.4 per cent. of the total consumption in the United States. This was an increase of 35,000 cords over the quantity reported in 1909, but nearly 34,000 cords less than that reported in 1907. About 45 per cent. of the pulpwood consumed in this state during 1910 was imported. The consumption in Maine during the same year was 917,029 cords, or 22.4 per cent. of the total quantity used in the United States. This quantity was about 13,000 cords in excess of that consumed in 1909, but about 25,000 cords less than the reported consumption in 1907. Less than one-fifth of the pulpwood used in Maine during 1910 was imported. The state third in rank was Wisconsin, with 523,924 cords, or 12.8 per cent. of the total. Almost the entire amount used in this state in 1910 was domestic wood. In New Hampshire, which ranked fourth, 423,931 cords, or 10.4 per cent. of the total, were consumed in 1910. This quantity, more than one-half of which was imported, was less by about 5,000 cords than that used in 1907. Pennsylvania was the only state, other than those mentioned, which consumed more than 300,000 cords of pulpwood in 1910. The combined consumption of these five states was 3,143,961 cords in 1910, or 76.8 per cent. of the total, as compared with 3,046,898 cords, or 76.1 per cent. of the total, in 1909.

Total quantity of pulp produced in 1910, 2,533,976 tons of 2,000 pounds each, exceeded that produced in 1909 by 42,570 tons, or 1.7 per cent., but it was less than the quantity produced in 1907 by 13,903 tons, or 0.5 per cent., despite the fact that over 3 per cent. more wood was used in 1910 than in 1907.

The quantity of pulp secured per cord of wood varies in the different states and in the same state in different years according to the kind and quality of wood used and the process of manufacture. In the majority of the states shown separately,



an increase in the quantity of pulp produced in 1910, as compared with 1909, accompanied an increase in the quantity of wood used or decreases occurred in both items, while in some, like Massachusetts, Vermont, Virginia, a greater quantity of pulp was produced from a smaller quantity of wood. In Oregon more wood was used in 1910 than in 1909, but less pulp was produced.

The average yield per cord of pulpwood, without distinction as to kind of wood or process used, was 1,238 pounds in 1907. The yield of pulp per cord of wood is approximately 2,000 pounds by the mechanical or ground-wood process, and about 1,000 pounds by the sulphite, soda, and sulphate processes.

Canadian spruce and poplar were, with the exception of a small amount of basswood, the only woods imported in 1910, spruce supplying over 95 per cent. of all the material imported in that year. Pulp wood was brought from Canada into every state touching the international line from Maine to Minnesota, but New York, New Hampshire, and Maine used the largest quantities of wood from this source.

Of the wood used in the manufacture of pulp in 1910, 54.9 per cent. was reduced by the sulphite process, 28.8 per cent., by the mechanical process, and 16 per cent. by the soda process, while the percentage reduced by the sulphate process was only 0.2. As compared with 1909, increases are shown in the proportions reduced by the sulphite and soda processes and decreases in the proportions reduced by the mechanical process and the sulphate process. Hemlock and balsam fir are the only woods for which the mechanical process was more extensively used in 1910 than in 1909.

Of the domestic spruce consumed in 1910, 49.9 per cent. was reduced by the mechanical process and 49.8 per cent. by the sulphite process, the amounts reduced by the other processes being negligible. Somewhat less than two-thirds of the imported spruce was reduced by the sulphite process and all the remainder by mechanical process. For 94 per cent. of the hemlock the sulphite process was employed, while 96.1 per cent. of the poplar was reduced by the soda process.

In the reduction of balsam fir, white fir, and slabs and other mill waste, the sulphite process was the principal method used. For cottonwood the mechanical process was more extensively employed than any other.

The total quantity of pulp imported into the United States during the fiscal year ending June 30, 1910, was 423,721 tons, while for the year ending June 30, 1911, the quantity was 550,898 tons. In both years more than one-half of the quantity imported was ground pulp. The imports were principally from Canada, Germany, Sweden and Norway. The exports of wood pulp are very small and have been decreasing for several years. In the fiscal year 1910 only about 9,000 tons were exported.

#### GLUE FOR GREASY PAPER.

Greasy paper goods require a specially made glue of extra adhesive qualities, in order to keep them together any length of time. Such a glue may be made by dissolving 25 parts of sugar in 75 parts of water, then adding 6.5 parts of slaked lime and heating the mixture for three days to 158 degrees Fahr. Then allow it to cool, pour it off clear after settling, and make up the evaporated water. In 40 parts of the clear solution soak 60 parts finely broken Cologne glue for three hours and then heat it in a closed vessel, stirring occasionally, for ten hours in the steam or water bath. The strongly alkaline glue is then neutralized with 20 parts of oxalic acid and finally 0.1 part of dissolved carbolic acid is added. Should the glue be too thick, it can be thinned with acetic acid, 10 per cent. of 90 per cent. acetic acid to the entire mass. With a glue made in the foregoing manner we can effect a good, durable adhesion on greasy paper goods. For the glueing of highly lustrous goods in the same manner, a specially prepared adhesive must be used, as ordinary glue dries out too much and cracks off. This defect can be easily remedied by adding some chloride of calcium to the glue. This absorbs moisture from the air and consequently never allows the glue to dry out to a brittle condition, without, however, impairing its adhesive property.



## Testing of Size

Dr. Kollman discusses in a German contemporary the best means for determining size. He summarizes the various tests as follows:—

### 1. Iodine Test:—

Albuminous bodies, which include animal glues, give with iodine solution either direct or, on souring with acetic acid, yellow or brown colorations or precipitates. The iodine solution is made by dissolving as much iodine in a 1 per cent. solution of potassium iodide as possible. The reaction must be observed not only with the sized fibre, but with an aqueous extract of the paper. If some of the paper, teased out with a needle on the slide, is dabbed with the solution, a brown color is produced, whether the sizing is resin or animal. If, however, the paper is heated on the slide with a little water, and then removed, the dried residue on the slide shows characteristic appearances under the microscope and even under a good hand lens.

Animal sized paper leaves behind a considerable structureless residue extending over the whole surface formerly occupied by the water. The iodine solution gradually dissolves it with a rusty red color. On the other hand, resin sized paper leaves but little residue, and that shows a grainy structure with an irregularly dented edge round the space formerly taken up on the slide by the watery solution. This residue also gives a brown color with the iodine solution. It consists of free resinic acid, melted out by the hot water, and forming an irregular deposit against the dry part of the glass.

### 2. Nitric Acid Test:—

On heating with strong nitric acid, and especially on after treatment with ammonia, albuminoid bodies give a more or less pronounced yellow color. This is the so-called Xantho proteine reaction. Many resins and alkaloids give a similar result. The test is applied as follows:

A small piece of the paper is treated on the microscope slide with strong nitric acid, carefully dried, and then treated with ammonia. If the paper was sized with animal size, the yellow will be

deeper. The difference is small, but with practice it can be safely used to distinguish between animal and vegetable size.

### 3. The Milton Test:—

When warmed with this reagent (a solution of mercuric nitrate containing nitrous acid) all albuminous bodies, and, therefore, animal size, are colored red, from a light pink to a deep brick red. The reagent is best prepared shortly before use by dissolving one cubic centimetre of mercury in 9 c.c. of nitric acid of 1.52 S. G., and diluting the solution with 10 c.c. of distilled water. The use of it is as follows: To a few drops of it in a watch glass add just the smallest possible fragment of sodium nitrite, to insure the presence of enough nitrous acid. A drop is then transferred by means of a glass rod from the watch glass on to a scrap of the paper to be tested on the slide, which is then carefully heated. In the presence of albuminous bodies, the paper turns red, the shade being pale or dark according to the amount of size present. The red soon changes, however, to a dirty brown, and if the Millon reagent is not fresh, the characteristic pinks and reds may be lost altogether. This yellowish brown is the only color produced by the reagent in the case of resin size. This test, too, is only reliable in experienced hands.

### 4. The Kiliani Test:—

This consists in heating with yellow mercuric oxide until the mercury is reduced to the metallic state. The reducing power of animal size is greater than that of vegetable size, but the test, much boomed at one time, has proved valueless, and is mentioned here only by way of warning.

### 5. The Raspail Test:—

This depends on the fact that proteids, resins, fats, etc., turn rose colored or violet under the action of concentrated sulphuric acid, and a little strong cane sugar syrup. Animal size shows the reaction much weaker than resin size, so that the reaction only comes into question for the recognition of the latter. The test can

only be carried out satisfactorily under the microscope.

The procedure is to dampen a little scrap of paper with the sugar solution, put it on the slide, free it from excess of sugar by lightly pressing blotting paper on it, and then to add the strong sulphuric acid when the paper is already under observation with a low paper. In this case nothing much will be seen if the sizing is animal, but with resin sizing deep red color will appear at the parts of the paper attacked by the acid.

#### 6. The Biuret Test:—

Albuminous bodies treated first with caustic potash lye, and then with solution of sulphate of potash, give colorations of red and violet. The value of this test consists in the fact that it gives a fully negative result with resin size. This test is also best tried under the microscope. A little bit of the paper is wetted on the slide with caustic potash lye of about 10-15 degrees B., and after a minute or two has been given to enable the caustic alkali to dissolve the size, one drop of a 2 per cent. solution of copper sulphate is added from the end of a glass rod. The violet shows best in the fibre after the slide has been drained by setting it on edge.

#### 7. The Adamkiewicz Test:—

If albuminous bodies are warmed with a mixture of two parts of glacial acetic acid and one of concentrated sulphuric acid, many of them give a strong red or violet coloration. Casein shows this reaction, animal size does not. This test can only be applied to an extract made from the paper with dilute caustic potash. The paper is wetted with the lye on the slide, and then removed with a needle. The remaining liquid is made acid with acetic acid, and warmed to coagulate the casein. This is then washed by alternate moistening with water, and pressing with filter paper. It then gives the color with the mixed acids.

#### 8. The Tannin Test:—

Tannin precipitates animal size. Let a piece of paper be wetted and stuck on the slide, and warmed, the paper being then removed, and tannin solution added to the aqueous extract left on the slide.

No precipitate is caused if the size was resin, but a voluminous brown deposit easily watched as it appears through the microscope is formed in the case of animal size.

#### 9. Extraction Test:—

This depends on extracting resin from the paper with solvents that will not dissolve animal size, but like the Kiliani test, it has failed so completely that it merely needs mention.

The tests should be carried out on the stage of the microscope whenever possible, so that the colors and precipitates can be observed as they form. The colors are very fugitive, especially under the strong light from the mirror below the stage. If the presence of both sorts of size is suspected, care must be taken to test for them on different portions of the paper.

### R. O. SWEEZEY ON QUEBEC'S RESOURCES.

Mr. R. O. Swezey, Forestry Engineer, Quebec City, on the 17th ult., spoke at a banquet of the Society of Chemical Industry and American Chemical Society in Boston, Mass. There was a large attendance of business men and others. He referred in untechnical language to the Indians, water-powers, railroads, agricultural possibilities, etc., of the Province of Quebec, and dealt at greater length with its forests and pulp and paper potentialities. In connection with the latter, he showed how the annual increment to Quebec's forests (exclusive of Ungava) is capable of supplying five million tons of paper, or nearly one-half the world's supply. Of that only one and a half million tons, or the equivalent thereof, is being cut per year at present.

Dealing with the water-powers, Mr. Swezey pointed out that Quebec can develop some (8,000,000) eight millions h.p., of which only (300,000) three hundred thousand is yet developed.

He also dealt at some length with the mineral resources of Northern Quebec, with which the speaker's extensive explorations had made him more or less familiar. Ungava came in for a share of

attention, but chiefly in regard to its mineral prospects and water-powers.

Labrador and Newfoundland were also dealt with as regards their timber or pulp and paper future.

---

### NEW INCORPORATIONS.

St. George Townsite, Limited, Vancouver, capital \$10,000; to deal in pulpwood.

\* \* \*

Chase Publishing Co., Chase, Yale Co., B.C., capital \$10,000; to do business as publishers of newspapers, books, magazines, etc.

\* \* \*

Eganville Pulp, Milling & Manufacturing Co., Ltd., Eganville, Ont.; capital \$225,000. To operate pulp and lumber mills, develop water powers, etc. H. Doner, Dr. W. J. Maloney, and Alex. Mills, all of Eganville.

\* \* \*

Hood, Sandham Co., Ltd., Toronto; capital \$40,000. To do business as engravers, map publishers, printers and binders, etc. F. C. Hood, C. A. Sandham and A. Annandale, all of Toronto.

\* \* \*

Continental Boxboard Co., Toronto; capital \$500,000. To make and deal in all kinds of paper products. E. C. DeWitt, Lawrence Darr, W. J. Alford, and J. C. McGonigle, all of New York City, and W. J. Alford, jr., Anderson, Ind.

\* \* \*

La Compagnie Electrique des Laurentides, Limitée, St. Lin des Laurentides, Que.; capital \$149,000. To develop water power, supply electricity and manufacture pulp and paper. A. Roy and L. Ven, of Laurentides, Que.; Jos. F. Daniel, of St. Esprit, Que., and J. U. Foucher, Montreal.

\* \* \*

Barber Paper and Coating Mills, Limited, Toronto, capital \$1,500,000; to manufacture, buy, sell and deal in all kinds of pulp and paper. Names of incorporators are:—G. H. Sedgewick and A. G. Ross, barristers; E. V. Macmillan, solicitor, and some law students, all of Toronto, but really a merger of the Canada Coating Mills and the Georgetown Paper Mills.

The Church Printing and Supply Company, Ltd., Toronto, capital \$40,000; to take over the printing business of Geo. Parker & Sons, in Toronto, and to do business as publishers and proprietors of newspapers, magazines and books, etc. A. E., S. C. and W. H. Parker, printers, and A. Rennie Auld, merchant, of Toronto.

---

### THE CHEMIST AS AN AID TO EFFICIENCY.

The industrial chemist points the way to great increases in efficiency, particularly in the item of buying supplies, according to Mr. Arthur D. Little, president of the American Chemical Society. In a paper on "The Chemist in Manufacturing," he says:

Chemistry points out the only proper way to buy supplies, which is on the basis of their industrial efficiency by means of specifications defining the quality desired and rigid tests to make sure that quality is secured. Independent estimates by those in exceptional positions to know, place the efficiency value of supplies as purchased and used by American manufacturers at 60 per cent. of what it should be.

Similarly the industrial chemist has a large control over the efficiency of labor. He may increase this efficiency, that is, the output of the individual laborer, by supplying more efficient processes, as Bessemer did in case of steel, Tennant in case of bleaching, or Le Blanc and Solvay in the manufacturing of alkali. He may raise the efficiency of the laborer through education, as when firemen are instructed in proper firing methods, or when cooks in the sulphite pulp mill are given boiling schedules; in one instance within our knowledge such schedules raised the efficiency, not of the cooks alone, but of the entire plant as well, over 50 per cent.

Nowhere has the industrial chemist greater scope for the effective exercise of his trained and organized common sense than in the control of processes and the elimination of wastes, and nowhere are the results he has already obtained more valuable. Their influence upon productive

industry has been dramatic and profound. One need only point out that the whole art of modern steel-making is under the strictest chemical control; and quote Carnegie to the effect that it has been revolutionized thereby. No industry affords a better example of the value of such control or furnishes more striking instances of the profitable utilization of wastes. The conversion of slag to cement and fertilizer, the development of 10,000 h.p. from the waste gases of a single furnace, are but steps in the development which will soon make pig iron the by-product of the furnace which derives its chief revenue from the waste of yesterday. With the open-hearth furnace still utilizing less than 10 per cent. of the energy of its fuel, let no chemist think the door of opportunity has closed.

---

#### OPPORTUNITIES FOR EXPORT OF CANADIAN PAPER TO AUSTRIA.

By Oskar Sonnenschein, Vienna.

---

It is only a question of time, and as matters stand we shall not be kept waiting long, before we see the promising heading of this article carried out in fact. Meanwhile, Austrian paper exports to Canada decline rapidly—from 18,000 crowns in 1909 to 10,000 crowns in 1910, that is, by about 45 per cent., whereas, according to statistics printed lately in a Vienna Paper Trade Journal, the total export of the Austrian paper trade declined from sixty-six millions of crowns in 1906 to some 39.7 millions of crowns in 1909, that is, by about 40 per cent.

To duly weigh this poor result, it must be remembered that, generally speaking, paper is not a luxury, but a bulk article, the consumption of which grows with the increase of population and the progress of intelligence, and that there is practically no foreign country, no export market, where this is not the case; further, all paper-making countries, with only a few exceptions, are profiting by this natural increase in exportation. To these few exceptions Austria belongs, I am sorry to state.

The downfall of the Austrian paper export trade is only one link in a long chain of deterioration in our balance of trade. It is not of much practical use pointing out the strength of Austrian industries, and particularly that of the Austrian paper mills, when they are not prepared to utilize it more extensively.

For the benefit of my compatriots, the Austrians, I have devoted a series of articles to the pros and cons of Government subsidies much in vogue here for the aid of the export trade. I have also suggested various ways how to promote our export without subsidies, and I have directed the public attention to points antagonistic to the Austrian export. With reference to the paper trade, the conclusion formed is, in a nutshell: The Austrian paper-makers are too well off in Austria. The little that Austrian paper-makers produce, they easily sell, through protection, at high rates, in Austria.

In foreign countries new paper-making machines are being constantly erected to answer the ever-increasing demand for paper in the world's markets; in Austria such an event would be as exciting as a coming comet. "No over-production," is the favorite motto of Austrian paper-makers, desirous to keep up top rates at home; but "Our field is the world!" is the idea of their competitors in foreign countries. And the more foreign paper-makers are gaining strength by confining their make to special lines and by enlarging their outputs by modern machines and appliances, the less Austrian paper mills evidently will export and the nearer seems to draw the possibility of importing paper to Austria more advantageously than to make it in Austria, in spite of protective duties.

Some 25 years ago, when I entered the paper trade, England, for instance, was partially dependent on Austrian paper supplies, and no one in Austria thought it possible that British makes would find their steady way into our market. Things have changed meanwhile. And after touring around the globe for years, I now find it quite natural that matters should have come in to their present class in Austria.



No Canadian paper is imported here at present. However, as we eat lots of Canadian apples in Austria, though we grow delicious apples sufficiently, and to our farmers' view, cheaply, I cannot see why we should not print our dailies on Canadian news, and write our letters on "Patricia Bond" or "Ontario Linen," in the near future, though, undoubtedly, we make paper in Austria more than we use, better than it is appreciated, and considerably cheaper than it is sold.

Canadian paper-makers, keep your eye on Austria! It will pay both you and your clients. Not only will your exports to Austria pay you, but also such of your exports to other parts of the globe, to substitute for that share, which the Austrian paper trade is continually losing. You have the intelligence and strength to produce what is wanted, by partly changing and refining your make to suit requirements abroad; you have the push to go ahead, and you have the chance to do it!

## Trade and Manufacturers' Notes

### AN AUTOMATIC WASTE DETECTOR.

One of the most important features of the "Pneumatic Save-All" is the constant, visible check it affords upon the manner in which the mill is running. In this respect it is entirely unique. There is always some leakage of fibre in the waste water, and this (even at its normal or average rate of flow) usually represents a very considerable sum. But in addition to this there often occurs some sudden excess of waste, which it is very important to detect promptly. One of the shortcomings of older save-all methods was that they not only failed to show up such leaks, but that their own normal working was disturbed by a sudden inflow of extra waste.

The pneumatic save-all mechanism is entirely contained in a tank of very moderate size (in fact, from three to six complete save-alls are ordinarily shipped on one flat car together). As fast as the water flows in it is drawn out through a pneumatic trap or water seal. Whatever waste fibre was contained in the water is lifted out by pneumatic action and forms into a sort of blanket on a rotary screen or cylinder. From this cylinder it is continuously lifted off by a suitable air jet and deposited upon an inclined chute that is so placed as to be conspicuously in sight.

Whatever sudden excess leaks occur simply tend to make this mass of fibre larger. It requires very little practice therefore for anyone watching the save-all in use to estimate at a glance the normal thickness of this mass of pulp, and any increase is immediately noted. But it is possible even to go much further than this with the operation of the machine in cases where it is not desirable to trust to the eye or to admit too many spectators to the records of leakage thus shown up. In such cases save-all is sometimes concealed by a partition, and is so connected up that the amount of stock delivered by it may be weighed up for every shift of men or even for any individual machine operated. The superintendent has charge of this operation, and thus keeps a valuable check on his working force. And, evidently, with such a check as this upon the operation of the men and machinery, a better estimate is possible of the work the men are doing.

This method is perfectly acceptable to all concerned, as it gives an incentive to get the best results—and the rewards which accompany them in one way or another. The method corresponds exactly to the method of inspection of work normally employed in machine shops, and is strictly in line with the modern tendency to increase the efficiency and the earning power of every industrial process by checking wastes and preventing the losses which would otherwise result.



### PAPER DRYING APPARATUS.

The H. W. Johns-Manville Co., of Milwaukee, Wis., has recently been granted a patent on a new and ingenious method of increasing the drying capacity of any paper-making machine. This system has recently been placed on the market by the Badger Engineering Company of Milwaukee, Wis., who are the sole agents for this apparatus.

The apparatus consists of a fan, heater coils and a series of galvanized iron ducts, arranged in such manner that the air is taken from the outside and passed through the heater coils, where the temperature is raised from 120 to 125 degrees, and is then taken up by the fan and discharged

ping in cold weather unless the hood is used, because the vapors cling to the flat surfaces and rapidly condense to water. The hood meets this condition successfully. Where the roof has considerable pitch, excellent results for the entire elimination of vapors and drippage are secured without the use of the hood over the machine.

The advantages claimed by the manufacturers for this apparatus in actual practice are:—

First, it increases the production of paper when operating under like pressures, by enabling the machine to be operated at a higher speed, which varies from 5 per cent. to 50 per cent., depending upon the nature of the paper being run; or, in the event of the paper being run at its

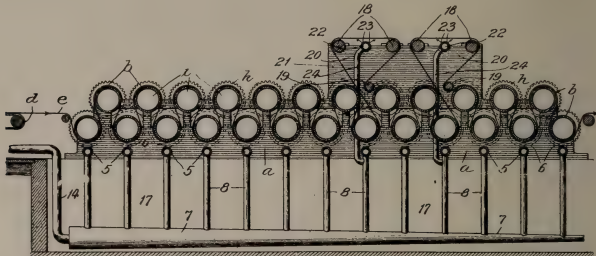

Vertical Section of a novel Paper Drying Apparatus recently patented by the H. W. Johns-Manville Co. View shows the paper passing over or through the rolls, another means of applying air directly to the paper.

into the machine room. A portion of the heated air is diverted and distributed along the machine and in between the dryers, thereby killing or eliminating the vapors which arise and securing the drying effect of the air required to properly ventilate the machine room.

In an apparatus of this nature it is necessary to treat the entire cubic contents of the machine room, because all of the air of the room must be changed from 3-12 to 5 times an hour in order to secure the best results,—namely, a machine room entirely free from vapors and drippage regardless of the outside temperatures—and accomplish this without the use of a hood over each machine.

With certain styles of roof construction, such as the flat roof without an air space, it is impossible to entirely eliminate drip-

ping in cold weather unless the hood is used, because the vapors cling to the flat surfaces and rapidly condense to water. The hood meets this condition successfully. Where the roof has considerable pitch, excellent results for the entire elimination of vapors and drippage are secured without the use of the hood over the machine.

When operating in conjunction with the steam engine, utilizing exhaust steam, this decreases the pressure necessary for successful operation, and by so doing increases the efficiency of the steam engine and makes a corresponding saving in fuel of 2 per cent. for each pound of back pressure removed.

Second, the "Loft Dry" effect is secured by the application of hot air to the dryers, as well as lower steam pressure, which produces a better and stronger paper than is had with the higher steam pressures.

In addition to the application of the hot-air to the machines, each dryer is provided with an automatic vacuum trap dis-

charging into a common return line to the vacuum pump. This device rapidly and effectively removes all air and water of condensation from the dryers, giving an even temperature throughout the entire width of the machine.

The vacuum pump discharges this air and water of condensation into a separate device, where the air is given up and the water is discharged into the feed water heater, and is then taken up to the boiler feed pump and returned to the boiler. By this method, all the benefits derived from absolutely pure water obtained by condensation, are secured; the boiler surfaces are clean at all times, and this produces a free steaming surface, and makes a corresponding saving in fuel.

This paper-drying apparatus is fully covered by U.S. letters patent No. 1,018,903, issued under date of Feb. 27, 1912, to the H. W. Johns-Manville Company.

The Wayagmack Pulp and Paper Co., Ltd., Three Rivers, Que., recently awarded a contract to Messrs. Jones and Glassco, Registered, Montreal, Canadian agents for Hans Renold, Ltd., Manchester, Eng., covering over 40 Renold Patent Silent Chain Drives. These drives will operate the machinery of the evaporating house, which will be equipped with this form of transmission exclusively. The drives range in power from 5 h.p. to 100 h.p., and comprise probably the largest single installation of chain drives yet made in Canada.

### EFFECT OF IMPURITIES IN WATER ON PAPER

Naturally, water is never found chemically pure in any district; that which descends in rain is contaminated by the impurities it washes out of the air; that which rises in springs takes in solution and suspension the various substances present in the earth. River water contains organic and inorganic impurities from the surface over which it runs. Well waters sometimes contain animal and vegetable matter, and also mineral impurities; both in suspension and solution.

The color of the water varies according to the geology of the district. It is often a reddish color as it flows through rocks of red marl which contain much oxide of iron; it descends milky from the glaciers in Iceland owing to the white earth it holds in suspension; it varies from a grey to brown in the polluted rivers; it is always a brown color when it comes from boggy lakes or runs over peaty soil; it is almost black when it contains an excess of vegetable matter, and in some districts it varies in many shades of green owing to the yellow matters which it holds in suspension and solution. The real blue natural color of water is only apparent in clear and deep waters.

The clear, bright, and sparkling waters of springs and transparent rivers, even when filtered, are never chemically pure.

Some of the most important impurities present in water, which affect paper, are: Hardness, sodium carbonate, iron, lead, acids, and organic matters in suspension and solution.

The hardness of a water should always be ascertained, and more especially for paper manufacture, says a writer in *World's Paper Trade Review*. If a hard water is being used in the manufacture of paper it may be taken for granted that the finished paper will cost more to produce than a mill supplied with a moderately soft water, and the cost will be more according to the class of paper made.

If fine writings are being made from cotton and linen rags there will be an extra quantity of caustic soda used when boiling the rags in order to soften the water. More acid is required when bleaching, and more alum is required in the beating engine for sizing and dyeing the pulp, and the harder the water the more the expense in the various departments for softening the water. This is the reason why a water is generally used, tested for hardness, and, if found above 10 degrees, it is softened by chemical means. Temporary hard water which contains carbonates of lime and magnesia is rendered soft by milk of lime, 1 oz. of lime per 100 gallons for each degree of hard-

ness. The permanent hard water which contains sulphates of lime and magnesia, is reduced by sodium carbonate or caustic soda.

Water containing sodium carbonate should be neutralized with sulphuric acid or acetic acid, as it is injurious to mordants and dyes.

Iron is generally present as a bi-carbonate, and is very injurious when bleaching and beating, and more especially when used for making dye solutions. Water containing iron is not suitable for dissolving coal-tar colors; a portion of the color is precipitated as a tarry mass, and not only is the coloring matter wasted, but such solutions are apt to cause spots on the paper.

Lead in water is objectionable to the paper maker and especially when sulphur compounds are present, as brown lead sulphides are formed which show up as specks in the paper.

Water containing acids such as ulmic and humic acids in peaty water should be neutralized with carbonate of soda, as these acids possess a very solvent action.

The organic matter, whether vegetable or animal, in solution or suspension, is the most important impurity that requires treatment. The effect on paper of organic matter present in water are many. The chief are:—

(a) Alum, when used in the beating engine, so acts on the organic matters as to precipitate it in clots on the fibres, which ultimately show up in the finished paper in various ways.

(b) As water generally contains sulphate of lime, organic matters effect its decomposition by the formation of sulphuretted hydrogen, and this substance ultimately acts upon metal mordants and forms sulphides, which cause black and brown stains in the paper, and any paper that contains such impurities will not keep for any length of time, and should not be used for permanent records.

If organic matter is present the water should be treated with a solution of alum or permanganate of potash, and then

passed through a good sand filter before being used for paper manufacture.

#### CASEIN IN SIZING MATERIAL.

The operation of sizing paper with casein is conducted with the same apparatus as that commonly used for gelatin. The few modifications in its use take place in the "mill laboratory," that is to say, in the preparation of the coating size and in the drying operation. The casein is dissolved to saturation in beaters containing an ammoniacal lye (of ammonium carbonate), in preference to a soda lye, which yields an objectionable residue and evaporates less easily. To this ammoniacal lye there is added, sometimes 2 to 3 per cent. of sodium borate. The casein being once dissolved to a clear liquid, there is added to the mixture the proper amount of blanc fixe, or impalpable barium sulphate (obtained preferably as a by-product in the manufacture of peroxide of hydrogen).

After straining to eliminate lumps and shortly before use there is added to the mixture 3 per cent. of formaldehyde solution. It is again mixed and the size is now ready for use in the sizing vat. There, before being coated with size, the paper, in order to insure after drying, the insolubility of the casein and perfect sizing, is moistened by means of a humidifier, or formaldehyde solution is forced in by compressed air. Before entering the vat, the paper passes under a cotton or rubber roll which equally distributes this moisture over the entire surface and the operations which follow are similar to those observed in the gelatin process. Casein, used according to this method, gives a sizing as perfect as gelatin, while the formaldehyde prevents all subsequent fermentation, as well as odor and all mouldiness of the size, which is an advantage, as compared with gelatin. The quantity of casein used is less as compared with gelatin.

As regards color, the surface is of a more perfect whiteness than those made with gelatin, which always imparts a slight yellow tint, which is disguised by blueing. In the hanging room, drying is

effected more rapidly because casein can withstand a temperature of 114° F., as against 86° F., which must not be exceeded with gelatin coated paper. Besides, evaporation is facilitated by the ammonia. Paper coated with casein permit greater clearness of impression and give more richness of coloring in engravings.

Fine papers sized with gelatin are often unsatisfactory in cases where they are intended for printing. In place of employing gelatin in hot solution, kept hot in a steam-jacketed tank, the paper as it comes from the drying-room can be passed through a continuous bath made up of an ammoniacal solution of casein, identical with that used for coated papers, except that it is half as concentrated.

After this first bath, the paper passes through a second bath of formaldehyde solution, and through a press to remove the excess of moisture and regulate the coating. The paper should then be dried over a drier of 200 metal cylinders, covered with cloth and provided inside with ventilators controlling a current of hot air.

Paper made in this way absorbs printing ink without blurring, the color of the paper is a fine white and its imperviousness to moisture is good.

It may be stated that the employment of the cold casein bath makes unnecessary the use of the steam bath, required for heating the gelatin, which must be very carefully regulated to avoid decomposing the glue or to prevent the paper taking too much size, should the latter become too solid, on account of low temperature. This is a cause of irregularity in sizing which is avoided with the use of casein. As in the case of coated papers, papers sized on the surface with the aid of casein dry more rapidly than those sized with gelatin.

In the case of printing papers the manufacturer, in order to obtain papers taking ink well, is often compelled to have recourse to special compositions of pulp. Rosin sizing alone does not impart to these

papers sufficient imperviousness to oil, or rather to greasy printing inks, so that there will be no blur around the impression of the characters. Moreover, with these papers, in providing the quantity of rosin and other substances, as starch, to insure imperviousness to water, in the pulp there are obtained the qualities necessary for a paper that absorbs printing ink while insuring a clear impression.

Casein in such a case is said to yield excellent results. Acetate of casein is used in concentrated acetic solution.

For use, after having placed resin soap in the hollander, as usual, and in proportion reduced by nearly 50 per cent., there is added 2 to 3 per cent. (of the weight of the stuff) of solution of acetate of casein. By dilution in the water of the hollander, the casein is precipitated in turn by the aluminum sulphate. The acetic solution of casein contains the least possible excess of acetic acid, so as not to precipitate prematurely the resin soap, before the aluminum sulphate has acted. The slight excess of acetic acid serves to neutralize the salts of lime in the hollander water.

---

#### SUBSTITUTES FOR ROSIN.

---

Statistics seem to show that the present sources of rosin will be exhausted in about 25 years. Hence it is important to consider from a technical point of view the question of replacing it. As far as chemistry is concerned the problem is already solved, as there are now artificial rosins, largely used in the varnish trade. From the technical point of view there are only two possible solutions—one is to economize the rosin, the other is to replace it absolutely by an efficient substitute. Under the first head we have the extraction of rosin from wood as a preliminary to making paper pulp, and as a material useful for purposes apart from paper-making. Moreover, we have to consider sources of rosin hitherto unused, and, finally to save deficiency of it by proper cultivation of



the trees which yield both the raw material for paper pulp and rosin.

Rosin can be greatly economized by mixing it with other sizes, such as starch or dextrine. In respect of the attempts to oust it entirely we may mention the trials with stearamide and other artificial rosins.

Klemm has argued as follows from the various attempts: The extraction of rosin from wood is too expensive, and requires large quantities of solvents which are dangerous by reason of their inflammability. There seems, however, to be some field for the extraction of rosin from appropriate plants not yet used for the purpose. It would be particularly interesting to see if one could cultivate such plants. Good results have already been obtained in the South of France. The forests of Russia seem capable of yielding far more rosin than heretofore, but it would appear to be impossible at present to secure the necessary number of workers.

As regards adhesives to be used to augment the bulk of the rosin, some results have already been achieved. - All non hygroscopic fats may be regarded as substitutes for rosin, so that one is surprised that rosin is used at all. These fats often sweat during drying in free air, however, although not when dried by heat. The history of sizing processes shows that rosin has been preferred in cases when it might be replaced by other adhesives, e.g., in the manufacture of printings. Experience has shown that mineral sizing requires adhesives which prevents yellowing.

In Germany it has been calculated that the substitution of mineral sizing for rosin sizing would, in the case of printings, save a million marks a year which now go abroad.

Writing on the same subject, but taking a rather different view, M. Schwalbe says that all substances which can replace rosin have it in common that they are colloids. In respect of inorganic colloids, silicates can be used to replace rosin, and the failure that has taken place in certain cases is due to the fact that all attempts in keeping silica in the colloid form have so far been unsuccessful. Leaving aside the

albuminoids for the moment, the chemistry of colloids is still in its infancy. Nevertheless, they can be divided into four groups:

1. Substances soluble in water, such as fish and common glue.

2. Mucilaginous bodies, such as starch, tragacanth, viscose, and products from seaweed which are little known at present. (The companies which are formed to exploit these plants only speak of them when taking out fresh patents, but at the same time their use does not seem devoid of interest for they were the original raw material of washing soda.)

3. Emulsifiable substances, like rosin itself, for instance, greases and waxes, paraffins and artificial resins. Most of these bodies are too expensive for our purpose, especially Bachelite, a phenol formaldehyde product which seems fated never to be any cheaper.

4. Soaps, such as rosin or fatty soaps. The idea might arise that they could be made insoluble by the action of metallic salts on drying cylinders, as dressings are made in the textile industry.

The best way to solve the rosin problem seems to be to extract the rosin from the enormous quantity of wood used for making paper pulp. So long as only half the raw material is used the industry cannot be considered as perfected, and probably necessity will be the teacher to point out to the manufacturer of paper pulp the best practical means for obtaining the rosin from the raw material.

---

The next convention of the Canadian Forestry Association will be held in Victoria, B.C., upon a date to be fixed by Hon. Richard McBride, Premier of the Province.

\* \* \*

The St. Lawrence Paper Mills Co. has awarded contract for a 140-inch paper machine for the Montrose Mill at Thorold to Rice, Barton & Fales Machine & Iron Co., Worcester, Mass. The output of this mill will be 35 tons of book, bond and writing daily. Six beaters and three bleachers will also be put in. Construction work is making good progress.



## Pulp and Paper News

Mr. Millington, late of the Spanish River Mills, has gone back to the States.

\* \* \*

The Copp, Clark Co., Ltd., stationers, publishers, etc., Toronto, will build a four-storey warehouse to cost \$60,000.

\* \* \*

J. A. Hardisty, Montreal manager for the E. B. Eddy Co., has retired, and his place taken by T. Z. O'Neill.

\* \* \*

The Garden City Paper Mill, St. Catharines, Ont., which makes high-grade tissue papers, has started operations.

\* \* \*

The Laurentide Paper Co. is starting work on an extension to its sulphite plant, which will increase its capacity by 25 per cent.

\* \* \*

The Riordon Paper Co. is opening a saw-mill at Hawkesbury, Ont., to replace the one burned there a few months ago, and a log-cutting plant.

\* \* \*

The Laurentide Company is putting in three extra heavy two-roll wet machines made by Sherbrooke Machinery Company, Ltd.

\* \* \*

Some new machines are being installed in the newsprint mills of the Anglo-Newfoundland Development Co. at Grand Falls, Newfoundland.

\* \* \*

J. R. Booth's newsprint mill is running full capacity, notwithstanding the recent strike of beater men. The company experienced little difficulty in filling the places vacated by the strikers.

\* \* \*

The Toronto Paper Mfg. Co. held its annual meeting a few days ago, at which satisfactory reports were presented. John R. Barber, President, and the old Board of Directors were re-elected.

The Western B. C. Paper Co.'s plant at Sapperton is now ready for operation with an output of 15 tons of building, roofing and bag paper. Ultimately the company will make also pasteboard boxes.

\* \* \*

Ritchie & Ramsay, manufacturers of coated paper, New Toronto, have just completed a fine new finishing room, 97 by 95 feet. The mill will shortly be operated wholly by electric power, developed on the premises.

\* \* \*

W. P. Gundy, of the Kinleith Paper Mills, St. Catharines, and managing director of W. J. Gage & Co., manufacturing stationers, Toronto, has been elected President of the National Club, Toronto.

\* \* \*

The Crabtree Mills, Lake Oiseau, Que., which make wrapping papers, etc., and which were burned down a few weeks ago at a loss of \$70,000, will be re-built at once. Arrangements have been made to fill all orders.

\* \* \*

The British-American Wax Paper Co., Toronto, is extending its plant in order to meet the demand for bread wrappers, to provide for which on every loaf of bread sold by bakers a Toronto city by-law is being prepared.

\* \* \*

J. B. Beveridge, son of James Beveridge, (President of the New Brunswick Pulp & Paper Co., Millerton, N.B.), general manager of the Dryden Timber & Power Co., Dryden, Ont., was married last month to Miss N. Williamson, of Montreal.

\* \* \*

Sir Rodolphe Forget, M.P., Montreal, who is interested in large pulp and paper companies in Quebec Province, and who is popularly understood to have important merger plans in his mind, has returned from France.

\* \* \*

W. J. Egan, Canadian Trade Commissioner, Manchester, reports several contracts for wood pulp recently completed by British importers at good prices. He

thinks there are good opportunities for largely increasing this trade.

\* \* \*

Arrangements have been made for a merger of the plants of Wm. Barber & Bros. and the Canada Coating Mills, Ltd., Georgetown, and a company has been organized under the name of the Barber Paper & Coating Mills, Ltd., Toronto. (See "New Incorporations.")

\* \* \*

The Powell River Pulp & Paper Co., Ltd., is now manufacturing newsprint, its present capacity being 100 tons of ground wood daily, 50 tons sulphite, and news 100 tons, subject to a large increase when necessary with very little extra building.

\* \* \*

The Penn-Newfoundland Company, Ltd., Williamsport, Nfld., has purchased a large tract of timberland near Grand Lake, Nfld. A water power on the property is said to have a capacity of developing 25,000 horse power. Arrangements are being made for building a railroad.

\* \* \*

Arthur C. Hastings, the energetic and popular President of the American Paper & Pulp Association, New York, has returned home after a prolonged tour in England, Germany, France and Switzerland. In London, he was given a banquet in his honor by British paper makers.

\* \* \*

James J. Lanigan, president and treasurer of the Emerson Mfg. Co., makers of pulp and paper machinery, Lawrence, Mass., spent some days last month among the mills of Quebec and Ontario. Mr. Lanigan is the inventor of a direct electrical drive for a Jordan engine, an important improvement which will be noticed in our next issue.

\* \* \*

W. P. Ryrie, of Becker Co. of America, returned to Toronto from England on the 25th May. The Becker Co. have had a very satisfactory year, and Mr. Ryrie reports that the European pulp markets have improved in tone. The pulp imported from Canada last calendar year through Becker & Co. amounted to 152,000 tons.

\* \* \*

The Imperial Pulp Co., Winnipeg, in which T. A. Burrows, of Winnipeg, and

we understand, Hon. Clifford Sifton, are interested, is said to contemplate erecting a pulp mill on the Macleod River, 125 miles west of Edmonton, near the line of the G.T.P. Large supplies of pulpwood and a good water power are in the vicinity.

\* \* \*

The Lake Superior Paper Co. will have its new newsprint mill ready for operation next month. Its initial capacity will be 100 tons daily, to be increased later to double this. Two additional large-sized machines have been ordered. The company will shortly issue several million dollars' worth of bonds to provide for extensions.

\* \* \*

On the 24th ult., the first sod was turned for the new paper mills of the Ontario & Minnesota Power Co. at Fort Frances, which is to be completed within fourteen months. R. J. Young, the manager of the plant, in the absence of President Backus, presented the Mayor with a new shovel for the occasion. Not only will there be a newsprint mill, but a large book machine will also be erected.

\* \* \*

A report from Kamloops, B.C., states that a railroad may be built from Dunvegan to Bella Coola, where the Bella Coola Development Co.'s pulp mill has suffered from lack of labor and of transportation facilities. At present, it has to rely upon chartering and loading occasional steamers, and it therefore is not in position to take advantage of the best markets.

\* \* \*

The J. M. Voith Engineering Works, of Heidenheim, Germany, have issued a bulletin descriptive of the Voith grinder. This bulletin shows that the 1,000th grinder made by the firm has just been delivered since the works were established in a small way in 1876. Of this total 50 grinders with an aggregate capacity of 28,000 h.p. were shipped since the beginning of 1911. The firm's orders for pulp screens have reached a total of 3,500, some of these screens now having a capacity of 50 tons of pulp.

The Rolland Paper Co., of Montreal, have acquired the Northern Paper Mills at St. Adele, Que., and are overhauling the plant and adding machinery to increase the capacity by six to eight tons of paper per day. Most of this machinery is being supplied by Rice, Barton & Fales, Worcester, Mass. It consists of an 85-inch paper machine, 50 feet wide, 3 sets press rolls, 2 drum vertical reelers, slatter and winder, etc. The flotations of the stock of the new company is being made through the Royal Trust Co., of Montreal, the capitalization having been increased to \$1,000,000.

\* \* \*

St. John (N.B.) City Council have passed a by-law fixing the assessment on the Partington Pulp Co.'s mill at Lancaster for fifteen years at \$225,000. The company must spend at least \$100,000 on extending its plant within two years, and must eventually build a paper mill. The Partington Company has now taken over the property of the Gibson Lumber Co., including timber limits, mills and logs. The deal with the Consolidated Pulp & Paper Co. has, it is understood, been abandoned. N. M. Jones, of Bangor, Me., will become manager of the Partington Co.'s pulp interests. It is considering a plan to build another large pulp mill on Nashwaak River, near Fredericton.

\* \* \*

Edwin Crabtree & Sons, Crabtree Mills, Que., have ordered a new paper machine to take the place of the one destroyed in the fire. The new machine which has been ordered from Bertrams, Ltd., Edinburgh, will be longer, having a width of 94 inches. Work of rebuilding the mill on the old site has already begun and it is expected everything will be in readiness for operations this fall. The output will be 20 tons per day of the same grades as those previously manufactured. It is understood that the firm had intended to go into pulp making, but, naturally, that project will have to be abandoned at present. Meantime, arrangements have been made for the filling of orders and carrying on business as usual.

\* \* \*

Contract for the erection of the Ontario Pulp and Paper mills, Thorold, has been

let to the Lackawanna Bridge Company, Buffalo, N.Y., and work will be started at once. The mills will manufacture news print paper exclusively. They will be equipped with ground wood machinery of sufficient capacity to supply two 200-inch paper machines, which will turn out from 120 to 130 tons of paper daily. The machines are to be the largest ever built, and are now being constructed by the Pusey & Jones Company, of Wilmington, Del. The mill will be operated entirely by electricity, requiring about 10,000 horse-power, which will be secured from the Ontario Power Company at Niagara Falls.



## TENDERS FOR PULPWOOD LIMIT.

TENDERS will be received by the undersigned up to and including the 15th day of August next, for the right to cut pulpwood on a certain area situated on the Abitibi Lakes and River, tributary to the Grand Trunk Pacific Railway, and the Temiskaming and Northern Ontario Railway, in the District of Temiskaming.

Tenderers shall state the amount they are prepared to pay as a bonus in addition to dues of 40 cents per cord for spruce, and 20 cents per cord for other pulpwoods, or such other rates as may from time to time be fixed by the Lieutenant-Governor in Council, for the right to operate a pulp mill and a paper mill on or near the area referred to.

Such tenderers shall be required to erect a mill or mills on or near the territory and to manufacture the wood into pulp and paper in the Province of Ontario—the paper mill to be erected when directed by the Minister of Lands, Forests and Mines.

Parties making tender will be required to deposit with their tender a marked cheque payable to the Honourable the Treasurer of the Province of Ontario for ten per cent. of the amount of their tender, to be forfeited in the event of their not entering into agreement to carry out conditions, etc.

The highest or any tender not necessarily accepted.

For particulars as to description of territory, capital to be invested, etc., apply to the undersigned.

**W. H. HEARST,**

Minister of Lands, Forests and Mines.

Toronto, Ontario, May 15th, 1912.

## THE MARKETS

### BRITISH MARKETS.

London, May 28, 1912.

There is an improvement in the demand for mechanical pulp and prices are a shade higher. In chemicals, business is also more active.

Market for home and foreign rags is active with prices firm.

For chemicals a good demand is reported, especially for forward delivery.

### CANADIAN PULP AND PAPER MARKETS.

Toronto, June 10, 1912.

The situation in the paper trade was never better than it is to-day, so far as demand is concerned. All the newsprint mills are exceedingly busy and find difficulty, indeed, in keeping up with orders. These are good from domestic sources, while from the United States they are simply pouring in. The demand on account of Presidential elections seems to be unprecedented and the worst—or best—is yet to come. The output of the new Canadian mills would appear to be hitting the market at exactly the right psychological moment, but the general opinion is that even when the extra demand from this source ceases, no particular difficulty will present itself in finding a profitable market. Prices for newsprint are very firm.

The book mills are also quite active, while both for book, papers and writings prices are advancing and some of the chief manufacturers have withdrawn price lists, and others say they will follow the same course as soon as present stocks are exhausted. This is only in keeping with proper business methods in view of the constant increase in the price of raw materials. In the United States there has already been a substantial raising of quotations.

The better grades of Manilas have gone up a quarter of a cent in view of the better demand, and the burning of an important mill. Kraft may also go up a

little, though complaint is still heard as to quality of some lines.

Upward revisions have been made in the prices of paper bags, and the market for rags and paper stock keeps firm, but there is no particularly new feature.

In pulp, the state of the market is a little more indefinite. Consumers have been objecting to what they style the high prices asked, and have been slow in their orders. The manufacturers, however, point out that buyers must enter the market sooner or later, and that as soon as the probable low water conditions set in across the line there is bound to be a keen demand. They are, therefore, piling in considerable quantities. Sulphite is still very strong, and has advanced another dollar.

We quote:—

News print, rolled .....	\$2.00
News print, sheets .....	2.25
Book papers—Carload lots	
No. 3 .....	4½c.
Book papers—Broken lots	
No. 3 .....	4½ to 4¾c.
Carload lots No. 2 .....	4¾c.
Broken lots No. 2 .....	5½ to 5¾c.
Carloads lots No. 1 .....	5½ to 6¼c.
Broken lots No. 1 .....	6 to 6¾c.

Wrappings—

Manila B. ....	3 to 4 c.
Fibre . . . . .	3¾ to 4 c.
No. 2 Manila . . . . .	3½ to 3¾c.
No. 1 Manila . . . . .	3½ to 4¼c.
Kraft . . . . .	4 to 4¾c.

Pulp—

Ground wood (at mill).....	\$18
Sulphite (bleached) .....	50 to 52
“ (unbleached) . . . . .	to 42

Waste Papers—

	Per 100 lbs.
	F.o.b. Toronto.
No. 1 Hard White	
Shavings . . . . .	\$1.65 to \$1.75
No. 2 Hard White	
Shavings . . . . .	... to ...
White Envelope Cut-	
tings . . . . .	1.65 to 1.75
No. 1 Soft White	
Shavings . . . . .	1.25

# EMERSON MANUFACTURING CO.

LAWRENCE, MASS.

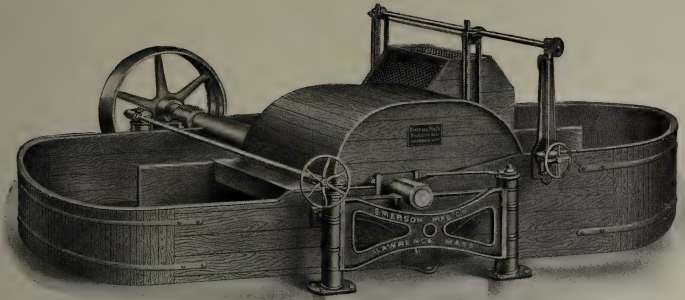

Beating and Washing Engines  
Paper Mill Machinery

**THE UNITED WIRE WORKS LTD,**  
EDINBURGH, GLASGOW & NEWCASTLE-ON-TYNE  
**FOURDRINIER WIRES, CYLINDER WIRES,**  
AND WIRE CLOTH OF ALL KINDS.

AGENTS, ARTHUR P. TIPPET & CO 8 PLACE ROYALE MONTREAL.  
WIRES HELD IN STOCK AT MONTREAL FOR PROMPT DELIVERY.

# ARTHUR P. TIPPET & CO.

AGENTS AND IMPORTERS  
PAPER MILL SUPPLIES  
SULPHUR FELTS

SAL AMMONIAC, BORAX, SANTITIE, ETC.  
MONTREAL, TORONTO.



No. 3 Soft White Shaving . . . . .	1.25
No. 3 Soft White Shavings . . . . .	1.10
White Blanks . . . . .	1.10
Mixed Shavings . . . . .	35 to 37½c.
Heavy Ledger . . . . .	\$1.27½ to \$1.40
Ordinary Ledger . . . . .	1.00 to 1.10
No. 1 Flat Books . . . . .	80 to 90c.
No. 1 Book Stock . . . . .	75 to 80c.
No. 2 Book Stock . . . . .	39½ to 40c.
No. 1 Manila Envelope Cuttings . . . . .	\$1.20
No. 1 Print Manilas . . . . .	65c.
Railway Manilas . . . . .	25c.
Folded News Overissues . . . . .	45c.
Folded News . . . . .	45c.
Crushed News . . . . .	..
No. 1 Mixed Papers . . . . .	25 to 35c.

**Rags (New and Old)—** Per 100 lbs.

1st Old White Cottons . . . . .	\$2.00
2nd Old White Cottons . . . . .	..
Thirds and Blues . . . . .	\$1.50 to 1.75
Roofing Stock—	
Flock Satinets . . . . .	75 to 80 c.
Ordinary . . . . .	55 to 60 c.
Tailor Sweepings . . . . .	55 to 57½c.
No. 1 White Shirt Cuttings . . . . .	\$4.75 to \$5.00
No. 2 White Shirt Cuttings . . . . .	.. to ..
Fancy Sheet Cuttings . . . . .	\$3.65 to \$3.75
New Blue Prints . . . . .	.. to ..
New Blue Overalls . . . . .	\$3.42½ to \$3.65
New Black Overalls . . . . .	1.60 to 1.70
New Black Linings . . . . .	1.60 to 1.75
New Unbleached Cottons . . . . .	.. to ..
Bleached and Unbleached Shoe Clips . . . . .	..
New Light Flannelettes. \$3.75 . . . . .	to \$4.40
New Light Shirt Cuttings 3.90 . . . . .	to 4.35
Light and Dark Cords. . . . .	..

**SCANDINAVIAN MARKET.**

The Norwegian trade paper Farmand, writes in a recent number:—

“Many of the Norwegian mechanical pulp mills have not only not had anything to sell for prompt delivery during the winter months, but they have been unable to deliver what they had previously sold. These mills have, consequently, been out of the market since the autumn, and none of the mills which have

been better situated with regard to water have had large unsold quantities for winter delivery, hence the market has appeared for weeks or say months to be quite inactive. It may be, however, that the winter sales, although individually small, have reached nevertheless in the aggregate a fairly respectable quantity. Those buyers who are in the habit of watching the market very closely have occasionally picked up some good bargains because all the sellers are not equally well posted. The extreme prices which were obtained in some cases for mechanical pulp in the closing week of last year have been proved by the experience of the first quarter of the current year to have been excessive. The paper makers have been able to hold back without buying much longer than was anticipated, and the pulp makers not having so good nerves as the paper makers they finally gave way. Prices have, however, fallen more than was necessary and this reaction seems at last to have spent its force and the market is, at this moment, quivering in the balance. There have been not a few inquiries lately for prompt and for delivery over the year and some fairly large sales have been made; the prices, which have been obtained, have been irregular, but a moderate advance from the recent lowest point has been established. The great heat of the past few weeks has caused a rapid filling of the Norwegian rivers and all the mills are now running with full power. The summer commences with small stocks of mechanical both in Scandinavia and in the consuming countries, and it is the impression that the full output will be needed.”

It is understood that arrangements for the absorption of the Ontario Pulp and Paper Company by The Spanish River Pulp and Paper Mills, Limited, which has been “in the air” for some time past, will be made shortly. The capitalization of the latter will likely be increased to permit of the merger and to provide for future extensions. Advances in the shares of the Spanish River concern have been a feature of the stock market for the last three or four weeks.

Telephone: 2726 BROAD.

Cable Address: "LAGERLOF NEWYORK."

# Scandinavian-American Trading Company,

PRODUCE EXCHANGE BUILDING, NEW YORK,

IMPORTERS AND EXPORTERS OF

FOREIGN AND DOMESTIC

# WOOD PULP

OF ALL KINDS

AND

# PAPER MILL SUPPLIES.

HANS LAGERLÖF, PRES.

ALL KINDS OF  
 Machines for Paper, Pasteboard,  
 Cardboard, Cellulose  
 and Pulp Mills

Paper Machines      Calenders  
 Winders      Calender Roll Lathes  
 Filters (Füllner's Construction)  
 Cutters      Cone Refiners  
 High Power Grinders      Patent Beaters  
 Edge Runners

FIRST CLASS REFERENCES

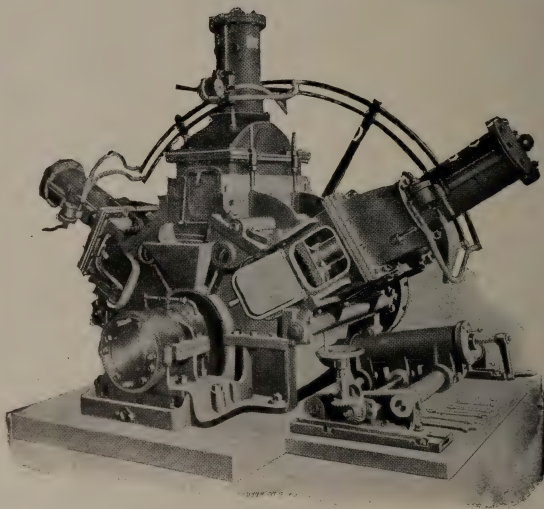

MOST MODERN CONSTRUCTIONS

Founded 1854

**H. FÜLLNER**

WARMBRUNN  
SILESIA  
GERMANY

Prizes won at all exhibitions where machines have been shown.  
 Turin 1911 "Grand Prize." Paris 1900 "Grand Prix" und "Kreuz der  
 Ehrenlegion." Leipzig 1897 "Gold Medaille." Paris 1907 "Grand Prix."

# CLASSIFIED ADVERTISERS' INDEX

If you fail to find what you want in these columns, write us and the desired information will be gladly supplied

## Architects and Engineers

Ambursen Hydraulic Con. Co.  
T. Linsey Crossley  
J. A. DeCew  
Eaton & Brownell  
Geo. F. Hardy  
Herbert S. Kimball  
International Process Co.  
Arthur D. Little, Inc.  
R. S. Lea & H. S. Ferguson  
Lyford, Clark & Lyford  
H. B. Prather  
Chas. B. Pride  
T. Pringle & Son  
Stebbins Eng. & Mfg. Co.  
R. O. and W. G. Sweezy  
Jos. H. Wallace & Co.

## Barkers.

Carthage Machine Co.  
Green Bay Barker Co.  
Jenckes Mach. Co.  
Waterous Engine Works.

## Beaters.

Dillon Mach. Co.  
Emerson Mfg. Co.  
H. Fuller  
Holyoke Mach. Co.  
E. D. Jones & Sons Co.  
Valley Iron Works  
Waterous Engine Works

## Beater Rolls.

J. A. DeCew  
J. Marx & Co.

## Belting.

Dom. Belting Co.  
F. Reddaway & Co.  
Sadler & Haworth

## Bleaching Powders.

Hooker Electro-Chemical Co.  
Winn & Holland

## Boilers.

John McDougall Caledonian Iron Works

## Brass Wire Cloth, Fourdrinier Wires.

Geo. Christie, Ltd.  
J. M. Douglas & Co.  
Herman Finckh  
C. H. Johnson & Sons, Ltd.  
Jas. Taylor  
A. P. Tippet & Co.  
United Wire Works  
P. P. Westbye

## Camel Hair Belting.

F. Reddaway & Co.

## Calender Rolls.

Farrel Foundry & Mach. Co.

## Chemicals, Colors, Etc.

Brunner, Mond & Co.  
Gewerkschaft Sachtleben  
A. Klipstein & Co.  
Hooker Electrochemical Co.  
Paper Makers' Chemical Co.  
A. P. Tippet & Co.  
United Alkali Co.  
Wilson-Paterson Co.  
Winn & Holland

## China Clay.

China Clay Co.  
A. Klipstein & Co.  
C. A. Meincke & Co.  
Paper Makers' Chem. Co.  
Wilson-Paterson Co.

## Chippers.

Carthage Machine Co.

## Conveying Machinery.

H. W. Caldwell & Son Co.  
M. Garland Co.  
Jeffrey Mfg. Co.

## Digester Lining.

Panzl Digester Lining Co.  
Preston's Digester Lining Co.  
Stebbins Eng. & Mfg. Co.

## Digesters.

Swenson Evaporator Co.

## Drainer Bottoms.

Samuel Snell Co.

## Evaporators.

Ernest Scott & Co.  
Swenson Evaporator Co.  
Zarembo Company.

## Exporters.

Parsons Trading Co.

## Felts.

F. Bredt & Co.  
Dallyn, Jardine & Co.  
Hamelin & Ayers Co.  
C. H. Johnson & Sons, Ltd.  
Penman's, Ltd.  
Joseph Porritt & Sons.  
J. H. Spencer & Sons.  
A. P. Tippet & Co.

## Fourdriniers Wires.

(See Brass Wire Cloth.)

## Grinders.

Carthage Machine Co.  
H. Fuller.  
Glens Falls Mach. Co.

Holyoke Machine Co.  
Jenckes Machine Co.  
J. M. Voith  
Waterous Engine Works

## Knives.

Crookes, Roberts & Co.  
Peter Hay Knife Co.  
A. P. Tippet & Co.

## Paper Mills.

Canada Coating Mills.  
Canada Paper Co.  
New Brunswick P. & P. Co.  
Northern Mills Co.  
Riordon Paper Co.

## Paper Presses.

Can. Boomer & Boschert Press Co.

## Paper and Pulp Dealers.

Atterbury Bros.  
Albert E. Mallandain.  
Castle, Gottheil & Overton  
Churchill & Sim  
International Process Co.  
Parsons Trading Co.  
Pulp and Paper Trading Co.

## Paper Stock, Rags, Etc.

Atterbury Bros., Inc.  
J. Christie Co.  
R. Hough  
The Howell Co.  
E. Pullan  
J. R. Walker & Co.

## Paper and Pulp Mill Machinery.

Appleton Machine Co.  
Beloit Iron Works  
Bentley & Jackson  
James Bertram & Son, Ltd.  
Bertram's, Limited  
The Black-Clawson Co.  
Canadian Boving Co.  
Carthage Machine Co.  
Chambers & Simpson  
Dillon Machine Co.  
Emerson Mfg. Co.  
Farrel Foundry & Machinery Co.  
H. Fuller.  
Julius Fischer  
Glens Falls Machine Wks.  
Green Bay Barker Co.  
Harmon Machine Co.  
J. H. Horne & Sons Co.  
Holyoke Machine Co.  
Jenckes Machine Co.  
E. D. Jones & Sons Co.  
C. H. Johnson & Sons, Ltd.  
Marx, J. & Co.  
Jas. Milne & Sons  
Moore & White Co.  
B. F. Perkins & Son

Rice, Barton & Fales  
Ryther & Pringle  
Sandy Hill Iron & Brass  
Works

Ernest Scott & Co.  
Sherbrooke Machinery  
Co., Ltd.

S. Morgan Smith Co.  
Stebbins Engineering &  
Mfg. Co.

H. F. Storrer  
Swenson Evaporator Co.  
Ticonderoga Machine  
Works

Valley Iron Works  
J. M. Voith

Charles Walmsley & Co.  
Chr. Wandel  
Wandel Screen Mfg. Co.

Waterous Engine Works  
Co., Ltd.

P. P. Westbye  
West End Engine Wks. Co.

Zarembo Co.

#### Paper Testers.

Dobler & Mudge.

#### Pipes (Wooden).

National Pipe & Foundry  
Co., Ltd.

#### Pumps.

Can. Boving Co.  
Carthage Machine Co.  
Dillon Machine Co.  
Lawrence Machine Co.  
Lawrence Pump & En-  
gine Co.

John McDougall Caledon-  
ian Iron Works.  
Smart-Turner Mach. Co.

#### Rosin Size.

Paper Makers Chemical  
Co.  
Vera Chemical Co.  
Wilson-Paterson Co.

#### Scales.

Alfred H. Mardon

#### Screen Plates.

Union Screen Plate Co. of  
Canada

#### Screens.

Glen Falls Machine Wks.  
Harmon Machine Co.  
Sherbrooke Machinery Co.  
J. M. Voith.  
Chr. Wandel  
Wandel Screen Mfg. Co.  
Waterous Engine Works  
P. P. Westbye

#### Slitters and Re-Winders.

H. Fullner  
Moore & White Co.  
Ticonderoga Mach. Co.

#### Sulphur.

Union Sulphur Co.

#### Talc.

Geo. H. Gillespie Co.

#### Tanks.

John McDougall Caledon-  
ian Iron Works

#### Transmission Machinery.

H. W. Caldwell & Son Co.  
Jones & Glassco  
Dodge Manufacturing Co.

#### Travelling Cranes.

Hugh R. Blethen  
Northern Crane Co.  
Smart-Turner Mach. Co.

#### Turbines.

J. M. Voith  
S. Morgan Smith Co.

#### Water Wheels.

John McDougall Caledon-  
ian Iron Works  
Holyoke Machine Co.

#### Wood Pulp Agents.

Castle, Gottheil & Over-  
ton  
Churchill & Sim  
Parsons Trading Co.  
Scandinavian Amer. Trad-  
ing Co.

# CALDWELL

ELEVATING, CONVEYING AND POWER  
TRANSMITTING MACHINERY  
FOR PULP AND PAPER MILLS

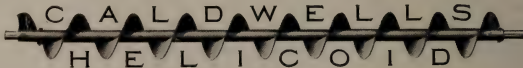

Helicoïd and Screw Conveyors. Belt Conveyors.  
Drag and Cable Conveyors. Gears, Cut or Cast Teeth.  
Mortise Wheels. Shafting Bearings, etc., etc.

SEND FOR CATALOG NO. 34

## H. W. CALDWELL & SON CO.

CHICAGO: 17th St. & Western Ave.  
NEW YORK: Fulton Building, 50 Church St.



# J. H. Horne & Sons

COMPANY

Lawrence - - - Mass.

---

---

MANUFACTURERS OF  
**PAPER MILL  
MACHINERY**

---

---

Fourdriniers  
Cylinders and  
Wet Machines  
Improved Horne Engines

Horne Jordan Engines  
Double Bevelled Roll Bars  
Horne Friction Cullers  
Barbed Jordan Bars

SEND FOR CATALOGUE

## Custom Grinding

---

---

Send your rolls to us, whether Paper, Cotton, Chilled Iron Brass or Rubber, and we will guarantee to give you a perfect job of grinding at most satisfactory prices.

---

---

**B. F. Perkins & Son, Inc.**  
HOLYOKE - MASS.

**FROZEN PULP AND DRY PULP  
IN A**

## Ryther Shredder

Is shredded at the rate of 5 tons per hour, 17 to 25 H. P. required. The above figures are *dry weight* and absolutely guaranteed.

RELIEVE YOUR BEATERS and INCREASE QUALITY and PRODUCTION. Write for full Particulars.

---

---

**Ryther & Pringle Company**  
Carthage, N.Y.

# TURBINE PUMPS

SPECIALLY DESIGNED FOR

# PAPER MILL WORK

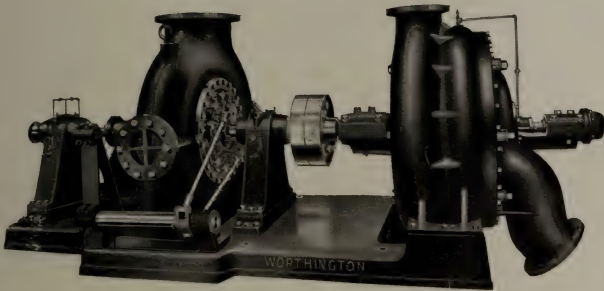

Turbine Pump, capacity 4,000  
U. S. gals. against head of 340  
ft., driven by water wheel, 600  
h.p. at 1,000 r. p. m.

**THE JOHN M<sup>C</sup>DOUGALL  
CALEDONIAN IRON WORKS CO.  
LIMITED**

**WORKS—WILLIAM AND SEIGNEURS STREETS, MONTREAL**

**PRESTON'S**

# Lining for Sulphite Digesters

TOTAL THICKNESS ONLY  $2\frac{1}{2}$  TO  $2\frac{3}{4}$  INCHES

Resists the action of the acid and ensures absolute protection to the Digester Plates.

Great durability, therefore large saving in upkeep and repairs.

Larger internal space and increased production on account of the small thickness occupied.

Extensively adopted by Scandinavian and Continental Mills.

Over 200 Digester Linings in work and on order.

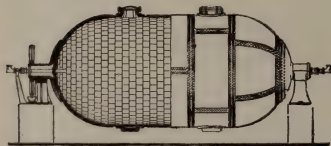
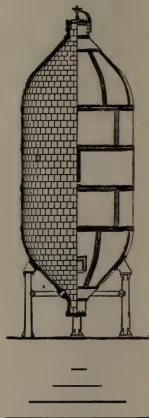

Telegraphic Address :

**"PRESTONS, RADCLIFFE."**

CODE USED A. B. C., 4TH & 5TH EDITION.

*Full Particulars and Prices on application to SOLE MANUFACTURERS*

**PRESTON'S DIGESTER LINING CO., LIMITED**

**RADCLIFFE, near Manchester, Eng.**

---

---

FARREL FOUNDRY AND MACHINE  
COMPANY

ANSONIA, CONN., - - - U. S. A.

Largest Manufacturers in the world of

**CHILLED ROLLS**

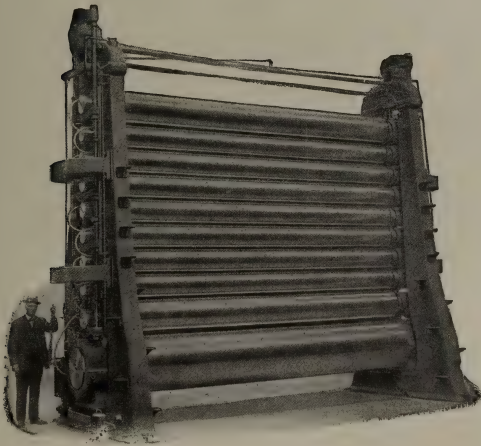

**CALENDERS**

*WITH PATENT HYDRAULIC LIFT*

**ROLL GRINDING MACHINES**

---

---



*Would YOU like to enlarge your Business and find new Customers in all parts of the world? If so, ADVERTISE in*

# “THE PAPER-MAKER AND BRITISH PAPER TRADE JOURNAL.”

THE LEADING AND MOST POPULAR TRADE ORGAN.

**THE ADVERTISER IS GOOD FOR THE READER**

We recently received the following letter:—

“We have hesitated over the matter, as we are at present so busy as to regard further advertising as almost superfluous.

“On the whole, however, we find it pays us better to have to refuse orders than to hunt after them, and will ask you therefore to insert our advertisement on same terms as last.

“We enclose herewith amended matter for advertisement, and shall be glad to have proof of same at your early convenience.”

We are constantly in the receipt of gratifying letters relative to the usefulness of our Journal, and we have pleasure in printing the following:

“Gentlemen,

We beg to advise that we have not as yet received the June number of ‘THE PAPER-MAKER AND BRITISH PAPER TRADE JOURNAL.’

We like the publication so well that we should be very sorry indeed to miss a copy of it.

Thanking you in advance for your kind attention,

We are, dear Sirs, yours very truly,  
F. R. KEYES & SON.  
20 Broad Street, New York.”

## S. C. PHILLIPS & Co.'s STANDARD PUBLICATIONS

### The Paper-Maker

AND BRITISH PAPER TRADE JOURNAL.

Published on the 1st of each month. Price 1s., by post 1s. 6d. Annual Subscription 12s. 6d. post free.

### The Stationery World, Printing and Allied Trades,

AND FANCY GOODS REVIEW.

Published on the 25th of each month. Price 6d. by post 7½d. Annual Subscription 5s. post free.

Chief Offices:

### The Paper Box and Bag Maker.

Published on the 19th of each month. Price 6d., by post 7½d. Annual Subscription 6s. 6d. post free.

### Phillips' Paper Trade Directory of the World

15s. 6d., post free to all countries.

NEW EDITION FOR 1911 NOW READY.

Specimen Copies and Advertisement Rates  
FREE OF APPLICATION.

47 CANNON STREET, LONDON, E.C. (ENGLAND).

# PAPER AND CLOTH SPECIALTIES

For Rent and Club Cards, Pattern Cards, Map Printing,  
Label Printing, Envelopes, Etc., Etc.

*Cloth Lined Papers. Cloth Centred Papers and Boards. Cloth Lined, Chromo and Enamel. Cloth Lined Boards and Cards, (surfaced and enamelled). Cloth centred Boards, (surfaced and enamelled). Manilla Surfaced Boards and Cards.*

ALSO

*Enamelled Blotting.  
Art Papers.*

*Paste Boards.  
Chromo and Surface Papers.*

Customers' requirements in specialities are carefully considered and experiments conducted if necessary.

**ALBERT E. MALLANDAIN,**  
MANUFACTURER

OFFICES : 51 Cheapside  
London, E.C.

MILLS : Park Royal  
Willesden, London, N.W.

# HERMANN FINCKH

REUTLINGEN

*Established 1879*

GERMANY

---

# FOURDRINIER WIRES

---

**SULPHITE - MACHINE WIRES  
CYLINDER WIRES**

---

---

**P. P. WESTBYE, - Peterborough, Ontario**

*Sole Agent for Canada*

**PULP MILL CHEMIST** with twelve years' experience in Sulphite (Bleached and Unbleached), wants similar position, good draughtsman. Apply Box 30, Pulp and Paper Magazine.

**UNDER MANAGER.**—Young man, 14 years' practical experience in English mill making long elephants, news, all-wood printings, cream laid, etc. Experienced mill chemist—testing of papers, fibres, etc. Highest references. Address H. C., c/o Pulp and Paper Magazine.

As we are using all our Water Power at our Pulp Mill for electricity, we are disposing of the Pulp Mill Machinery—including Millard Patent Grinders which were in use only a few months and are absolutely as good as new, also Wet Machines, Barkers, Screens, Pumps, Piping, Shafting, Stones, etc., etc., all in good condition. Full information will be given upon application.

Apply Box "A,"

Pulp and Paper Magazine.

**FOR SALE.**—Special Second-hand cylinder mould, 48-in., diameter 84-in. face. Good as new. Can be used as Filter. For particulars, etc., address Box 32, Pulp and Paper Magazine.

**FOR SALE.**—Three Moreau Pulpwood Barkers, slightly used. Will sell at \$450 each. Apply to Stuart, Drinkwater & Hingston, Limited, 485 St. James St., Montreal, Que.

**WANTED.**—Superintendent for a new 150-ton ground wood mill. One with technical education preferred. Please state education and experience in full; also give age, if married or single, and salary asked for. Address Box 27, care Pulp and Paper Magazine, Toronto.

**PAPER MILL ENGINEER.**—Technical graduate, ten years' experience, now consulting engineer for one of the largest paper mills in United States, wants change. Open for engagement in near future. Will give part or whole time. Apply Box 26, Pulp and Paper Magazine, Toronto.

**WANTED IMMEDIATELY.**—Master mechanic, machinists, millwrights, and pipefitters for Canadian soda, pulp and paper mill now under construction. Only experienced men need apply. State wage and give references. Apply Box D, Pulp and Paper Magazine.

**AGENT WANTED,** by a London firm of Paper Merchants wishing to extend their business in Canada. All classes of English and foreign papers handled. Address with full particulars and references to Box 31, c/o Pulp and Paper Magazine.

**SUPERINTENDENT** for 25-ton mill making special papers, located in Province of Quebec. Give full details. Care of R. A. H., Pulp and Paper Magazine.

**GEWERKSCHAFT SACTLEBEN**

**Homburg-Niederrhein**  
GERMANY

Largest Makers  
of all Qualities

**Blanc Fixe**

Bright

Matt or Dull

Photographic

Three  
Varieties

SCOTT'S IMPROVED RECOVERY SYSTEMS  
FOR  
**SODA, SULPHATE & SULPHITE**

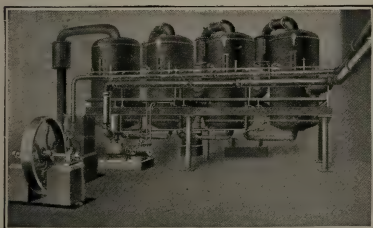

Spent Liquors give the  
MAXIMUM ECONOMY  
AND EFFICIENCY

The PRINCIPLE,  
The DESIGN,  
The CONSTRUCTION,  
The OPERATION,  
The RESULT,

**Is RIGHT**

Complete installations made by "THE FIRM WITH THE EXPERIENCE."

**ERNEST SCOTT & CO.** Manufacturing  
Engineers

FALL RIVER, MASS. and MONTREAL, P.Q.

SODA or SULPHATE  
**LAP-WELDED  
DIGESTERS**

Swenson Multiple Effect Black Liquor Evaporators.  
Rotary Black Ash Incinerating Furnaces.  
Complete Soda Recovery Equipment.

**SWENSON EVAPORATOR CO.**

945 MONADNOCK BLDG., CHICAGO

*People who are wise Advocate Forestry*

## The American Forestry Magazine

IS DEVOTED TO SECURING

**Better Fire Protection  
Fair Forest Taxation  
Lower Freight Rates**

**Proper Legislation  
Conservative Management  
and Reforestation**

It should be on the desk of every progressive American citizen. It is the public service publication of the American Forestry Association

AMERICAN FORESTRY MAGAZINE, ONE YEAR - \$2.00

Membership in American Forestry Association, One Year - \$1.00

Address AMERICAN FORESTRY ASSOCIATION  
Washington, D.C.

## A GOOD JORDAN ENGINE

BUILT IN 3 SIZES.



## THE BLACK-CLAWSON CO.

HAMILTON, OHIO, U.S.A

Builders of **PAPER MAKING MACHINES** and machinery for Paper and Pulp Mills. Our machines are completely erected in shop on cast iron levelling plates and carefully inspected before shipment.

*Write for Catalogue.*



# CHR. WANDEL

REUTLINGEN, - GERMANY

ESTABLISHED 1869.

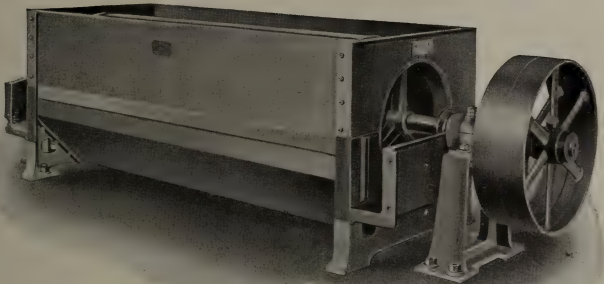

*Manufacturer of the*

## “ORIGINAL WANDEL” Rotary Sulphite Pulp Screen

Satisfactory service sure. Best by test. Beware of imitations. Largest screening surface, combined with small requirement of room. Absolutely reliable and noiseless work. No contact of the pulp with iron parts. Simple, durable, perfect. Price very moderate. The system now adopted by the most important Sulphite Fibre Mills of Europe. Prices and further particulars gladly furnished.

AGENT FOR CANADA WANTED

# TOWNSEND

## ELECTROLYTIC CELL

2,500-5000 AMPERE UNITS. ALKALI AND CHLORINE.  
CAUSTIC SO<sub>2</sub>A. BLEACHING POWDER. CHLORINE  
FOR ORES. LICENSES GRANTED. CANADIAN PATENTS  
91939 - 105088 - 105089.

**HOOKER ELECTROCHEMICAL COMPANY**  
40 WALL STREET, NEW YORK

## ZAREMBA EVAPORATORS

FOR RECOVERY OF

## SULPHATE OR SODA

*Horizontal Tubes*      *Automatic Feed Regulators*      *Easily Operated*  
*No Liquor Losses*      *Everything Accessible*      *Cheaply Maintained*

**ZAREMBA CO., BUFFALO, U.S.A.**

## Paper Coating and Colouring Machines

COMPLETE PLANTS AND ACCESSORIES

The best in the world.

To be obtained from

**Julius Fischer** Engineering Works **Nordhausen, H.**

GERMANY

*Excellent References in all countries.*

## THE PETER HAY KNIFE CO., Limited, GALT, ONT.

MACHINE  
KNIVES,  
CHIPPER,  
BARKER &  
PAPER-  
CUTTER  
KNIVES.



Made from the Best English Steel and Warranted.

VALLEY IRON



WORKS COMPANY

# BEATING AND WASHING ENGINES

IRON OR WOOD TUBS

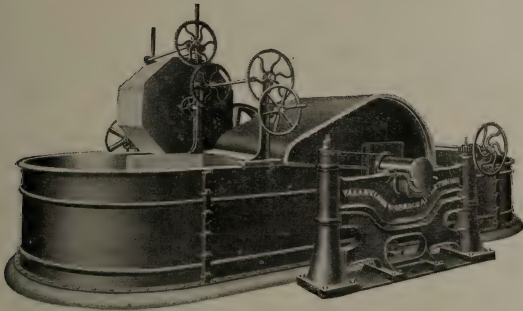

*Perfection in Every Detail*

Beating, Washing and Bleaching Engines. Barkers—Barker Attachments—Chippers—Rechippers—Chip Screens (Revolving)—Knot Screen (Revolving)—Diaphragm Screens—Felt Washers—Deckers (Single and Double)—Stuff Chests (Vertical and Horizontal)—Tanks (Blow Off, Acid and Water)—Pulpwood Saws (Friction and Steam Feed)—Pulpwood Splitters (Vertical and Horizontal)—Shredders and Special Washers for old Paper Stock—Wet Machines and Patent Roll Skinners—Bronze, Semi-Steel, Lead and Iron Castings.

**Manufacturers of Paper and Pulp Making Machinery in**

*All Standard Forms — Many Special Designs*

**ENGINEERS, FOUNDERS AND MACHINISTS**

*Correspondence Invited*

**VALLEY IRON WORKS COMPANY**

**APPLETON, WIS., U.S.A**

# CROOKES, ROBERTS & Co.

SHEFFIELD

ENGLAND

Makers of  
**Crucible Cast Steel**  
**Bed Plates**  
**Jordan Fillings**  
**Beater Bars**



Makers of  
**Bessemer Cast Steel**  
**Crookes' Composition**  
**Fillings**

And every description of Cutter Knives, Tools and Steel used and required in Paper Mills.

**ARGUS High-Speed STEEL** for fine machine tools is unsurpassed.

Once Used - Always Used  
**YOU SAVE MONEY USING "ARGUS" GOODS**

WRITE US

**ARTHUR P. TIPPET & CO.**

Agents for Canada

MONTREAL

# SPENCER'S

ALWAYS



RELIABLE

Best Wool - Best Weave - Best Wear

**J. H. SPENCER & SONS**  
**BURY - ENGLAND**

Canadian Agents: **ARTHUR P. TIPPET & CO., MONTREAL**

# INDEX TO ADVERTISEMENTS.

(SEE CLASSIFIED ADVERTISERS INDEX ON PAGE XXIX.)

Ambursen Hydraulic Construction Co...lxiii  
 American Forestry Association .....xl  
 Appleton Machine Co.....vi  
 Atterbury Bros. Inc.....lx  
 Becker & Co. ....e.o.m.  
 Beloit Iron Works.....xiii  
 Bentley & Jackson .....v  
 Bertram, James & Son, Ltd.....xviii  
 Bertram's, Limited .....lxi  
 Black-Clawson Co., The .....xl  
 Blethen, Hugh R. ....lvii  
 Bredt & Co., F. ....l  
 Brunner, Mond & Co., Limited .....lxiv  
 Caldwell, H. W. & Son, Co.....xxx  
 Canada Coating Mills, Limited .....lv  
 Canada Paper Co., Ltd. ....lv  
 Canadian Boomer & Boschert Press Co...lviii  
 Canadian Boving Co. ....liii  
 Carthage Machine Co. ....xxiv  
 Castle, Gotthel & Overton .....l  
 Chicoutimi Pulp Co. ....e.o.m.  
 China Clay Co. ....xlviii  
 Christie, J. Co. ....lxiv  
 Christie, Limited, George .....lxiii  
 Churchill & Sim .....lx  
 Crookes, Roberts & Co. ....xlix  
 Crossley, T. L. ....lvi  
 Dallyn, Jardine & Co. ....l  
 De Cew, J. A. ....lvii  
 Dillon Machine Co. ....xiv

Dobler & Mudge .....vi  
 Dodge Mfg. Co. ....iv  
 Dominion Belting Co. ....xlvii  
 Eaton & Brownell .....lvi  
 Emerson Mfg. Co. ....xxv  
 Farrell Foundry & Machine Co. ....xxxv  
 Fischer, Julius .....xlii  
 Finckh, Hermann .....xxxvii  
 Fullner, H. ....xxviii  
 Garland, M. Co. ....xii  
 Gewerkschaft Sachtleben .....xxxviii  
 Gillespie, Geo. H. Co. ....lxiii  
 Glens Falls Machine Works .....iv  
 Green Bay Barker Co.....xxi  
 Hamelin, The, & Ayers Co., Ltd.....lviii  
 Hardy, Geo. F. ....lvi  
 Harmon Machine Co. ....viii  
 Hay Knife Co., Peter, Limited .....xlii  
 Holyoke Machine Co. ....xvi  
 Hooker Electrochemical Co. ....xlii  
 Horn, J. H. & Son .....xxxii  
 Hough, R. ....lxiv  
 Howell Co., The .....xlv  
 International Process Co. ....xlix  
 Jeffrey Mfg. Co. ....iii  
 Jenckes Machine Co. ....xvii  
 Johnson & Sons, Limited, C. H. ....xlvii

## HYDRAULIC TURBINES

One unit of six with a total capacity of 13,100 Horse Power furnished for the new plant of J. R. Booth, Ottawa, Ontario. We build Turbines for any power for heads from 3 to 600 feet.

WRITE FOR CATALOGUE



**S. MORGAN SMITH CO.,**  
 YORK - PA.



Jones, E. D. & Sons Co. ....	lii	Rice, Barton & Fales .. .....	ii
Jones & Glassco .....	xx	Riordan Paper Co., Limited .....	lv
Kimball, Herbert S. ....	lvi	Ryther & Pringle .....	xxxii
Klipstein & Co., A. ....	xlviii	Sadler & Haworth .....	li
Lawrence Machine Co. ....	xx	Sandy Hill Iron & Brass Works .....	x
Lawrence Pump & Engine Co. ....	l	Scandinavian American Trading Co. ....	xxvii
Lea, R. S. & H. S. Ferguson .....	lvi	Scott Ernest & Co. ....	xxxix
Little, Arthur D. Inc .....	lvi	Sherbrooke Machinery Co., Limited.....	xix
Lyford, Clark & Lyford .....	lvi	Smart-Turner Machine Co. ....	lxiv
Mallandain, Albert E. ....	xxxvii	Smith, S. Morgan, Co. ....	xlv
Marx, J. & Co. ....	viii	Snell, Samuel Co. ....	xlviii
Mardon, Alfred H. ....	lviii	Spencer, J. H. & Sons .....	xliv
McDougall, John, Caledonian Iron Works Co., Limited .....	xxxiii	Stebbins Engineering & Mfg. Co. ....	lvii
Milne, Jas., and Son .....	e.o.m.	Sweezy R. O. & W. G. ....	lvii
Moore & White Co. ....	xv	Swenson Evaporator Co. ....	xxxix
National Pipe & Foundry Co., Ltd. ....	xlviii	Taylor, J. A. ....	lxiii
New Brunswick Pulp and Paper Co., Limited .....	liv	Ticonderoga Machine Works .....	e.o.m.
Northern Crane Works, Ltd. ....	lxiv	Tippet, Arthur P. & Co. ....	xliv
Northern Mills Co. ....	lv	Union Screen Plate Co. ....	iii
Panzl Digester Lining Co. ....	liv	Union Sulphur Co., The .....	lix
Paper Makers Chemical Co. ....	lix	United Wire Works, Limited .....	xxv
Parsons Trading Co. ....	xxiv	Valley Iron Works .....	xliii
Penman's Limited .....	l	Vera Chemical Co. ....	lx
Perkins, B. F. & Son .....	xxxii	Voith, J. M. ....	vii
Phillips, S. C. & Co. ....	xxxvi	Walker, J. R. & Co. ....	lx
Porritt & Son, Joseph .....	l	Wallace, Jos. H. & Co. ....	lvii
Porritt Bros. & Austin .....	xlvii	Wallsley, Charles & Co. ....	xxii-xxiii
Prather, H. B. ....	lvii	Wandel, Chr. ....	xli
Preston's Digester Lining Co., Ltd. ....	xxxiv	Wandel Screen Mfg. Co. ....	ix
Pride, Chas. B. ....	lvii	Waterous Engine Works Co., Ltd. ....	lxii
Pringle, T. & Sons .....	lvi	Westbye, P. P. ....	xi-xxxvii
Pullan, E. ....	lii	West End Engine Works Co. ....	x
Pulp & Paper Trading Co., The .....	lix	Wilson-Paterson Co. ....	xxiv
Reddaway, F. & Co. ....	lii	Winn & Holland .....	lxiv
		Zarembo Co. ....	xlii

*Scandinavian Sulphite  
and Ground Wood  
Kraft Pulp  
Bleached Sulphate  
and Sulphite  
Austrian Bleached  
Mitscherlich*

Limited quantities still available  
Write us for quotations and  
quantities

**THE HOWELL CO.**

8-10 Wellington St. East

**TORONTO - CANADA**

**MAPLE LEAF**  
**STITCHED COTTON DUCK**  
**BELTING**  
**DOMINION BELTING CO. LTD.**  
**HAMILTON CANADA**

IF YOU HAVE NOT ORDERED A COPY OF  
THE NEW

## “CANADIAN PULP AND PAPER DIRECTORY”

DO IT NOW. Your promptness will save you \$1.  
The price after publication will be \$3. To sub-  
scribers before publication \$2.

ADDRESS—

**BIGGAR - WILSON, LIMITED**  
CONFEDERATION LIFE BLDG., TORONTO

## C. H. JOHNSON & SONS, Ltd.

WIRE WORKS, ST. HENRY, MONTREAL.

MANUFACTURERS OF

**Fourdrinier Wires, Cylinder Wires,  
Brass, Copper and Iron Wire Cloth, Dandy Rolls**

## PORRITT BROS. & AUSTIN

Stubbins Vale Mills—RAMSBOTTOM—near Manchester, England

Manufacturers of every description of

**FELTS AND JACKETS FOR  
PULP AND PAPER MILLS**

Agents for Canada: C. H. JOHNSON & SONS, Ltd., ST. HENRY, MONTREAL.

**WE MANUFACTURE Wooden Water Pipe** for Water Works Systems. **Specially Made Pipe** for conveying Chemicals. **Continuous Stave Pipe** or Power Plants.  
 Sizes from 2 inches to 12 feet diameter.

**NATIONAL PIPE AND FOUNDRY CO., LIMITED**  
 Works—ALEXANDRIA, Ont. 135 Board of Trade Bldg., MONTREAL, Que.

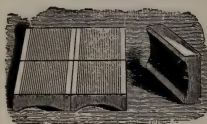

**Use Snell's Drainer Bottoms**

They drain quickly and don't let the Pulp go into River. **No Dust. No Splinters. Clean Stock.**  
*Send for Sample and Price*

**Samuel Snell Co., - Holyoke, Mass.**

Cable Address:—"Kaolin, Manchester." A.B.C. Codes 4th & 5th Edition

**CHINA CLAY CO.**

JOHN WILLIAMSON, Manager.

4 St. Anne's Square

**MANCHESTER, ENG.**

**MINES**—Ruddle, Bojea, Colchester, South Ninestones, Tronance, St. Austen Cornwall.

**CONTRACTORS TO H.M. INDIAN GOVERNMENT**

Canadian Representatives—C. A. Meincke & Co., 222 Coristine Bldg., Montreal.

**A. KLIPSTEIN & Co. Ltd.**

(OF CANADA)

12 ST. PETER ST. - - MONTREAL

**SULPHATE  
 ALUMINA**

**CHINA CLAY, BLEACH and CASEIN  
 PAPER BLUE, both Basic and Acid  
 AURAMINE - RHODAMINE**

and all other Aniline Colors

Shades Carefully Matched in our Laboratory Mention Pulp & Paper Magazine

**New York Office - 644-654 Greenwich Street.**

THE PROCESSES AND APPARATUS  
THAT MADE "KRAFT PAPER'S" SUCCESSFUL



CABLE ADDRESSES  
KRAFTLICH, NEW YORK  
IMPROKRAFT, LONDON.

AMERICAN OFFICES  
5 BEEKMAN STREET  
NEW YORK, N. Y.

EUROPEAN OFFICES  
SALISBURY HOUSE,  
LONDON, ENGLAND.

SOLE AGENTS IN NORTH AMERICA  
FOR  
CARL P. CARLSON, SWEDEN,  
EVAPORATORS AND LIQUOR SYSTEMS.

JULIUS PINTSCH, ACTIENGESELLSCHAFT, GERMANY,  
DIGESTERS, DIFFUSERS AND SPECIALTIES.  
SWEDISH SYSTEM OF RECOVERY FOR  
TURPENTINE, ALCOHOL AND OTHER BY-PRODUCTS.

# INTERNATIONAL PROCESS-CO.

ENGINEERS, CHEMISTS, PULP EXPERTS.

## LAWRENCE PUMP AND ENGINE CO.

P. O. BOX 70, DEPT. 10  
LAWRENCE :: MASS.

### CENTRIFUGAL PUMPS

We make an exclusive specialty of High Efficiency Centrifugal Pumps for Paper and Pulp Mill. In one mill 49 of our Pumps are running, the customer writes—"Your Pumps are all giving perfect satisfaction."

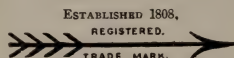
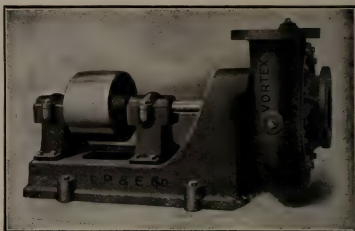

## FELTS For Pulp and Paper Mills.

### JOSEPH PORRITT & SONS

Agents for  
Canada  
and United  
States.

### HELMSHORE

Manchester, England.

All kinds  
Woollen, Lin-  
en and Cotton  
Cloths for  
Mechanical  
Purposes.

F. BRETT & CO., 240 Water Street, NEW YORK.

## PENMANS LIMITED

### ST. HYACINTHE, QUEBEC

Manufacturers of

### PULP AND PAPER MAKERS' FELTS, JACKETS, STRAINER CLOTHS, ETC.

Special sizes and qualities made to order. Satisfaction guaranteed.  
DALLYN, JARDINE & CO. TORONTO Selling Agents

## CASTLE, GOTTHEIL & OVERTON

200 Fifth Avenue, New York

AGENTS FOR

### **Sulphite and Wood Pulp Mills**

Dealers in all kinds of Paperstock, Sizing, etc.

Correspondence Solicited.





Waterproof  
**LEATHER BELTING**

Will give you more, per dollar  
 invested, than any other belt  
 you can buy, because

it costs less per day of  
 service

MADE ONLY BY

*Sadler & Haworth*

Tanners and Manufacturers

MONTREAL  
 511 William Street

TORONTO  
 27 Melinda Street

ST. JOHN, N.B.  
 89 Prince William Street

WINNIPEG  
 244 Princess Street

VANCOUVER  
 217 Columbia Avenue

*For over thirty-five years the makers of the best leather belts*

Nearly FIFTY YEARS ago we introduced this Belt. IT HAS STOOD THE TEST OF TIME

2" to 24" in stock

Every Belt is  
Stamped with  
Trade-Mark.

SOLE MAKERS



Write or phone us

Beware  
of Imitations

F. REDDAWAY & CO., MONTREAL, CANADA.

**E. PULLAN,** 490 Adelaide St. W.,  
TORONTO

Largest Paper Stock Dealer in Canada

**RAGS AND PAPER STOCK GRADED TO SUIT MILL REQUIREMENTS**

Correspondence Solicited.

EDWARD A. JONES, President and Treasurer

WALLACE E. BARDWELL, Secretary

**E. D. JONES & SONS CO., Pittsfield, Mass.**

Manufacturers of

**PAPER MAKING MACHINERY  
AND MECHANICAL ENGINEERS**

Beating Engines. Washing Engines. Mixing Engines. Bleaching Engines.  
Cooking Engines. Vertical and Horizontal Stuff Chests.

Jordan Engines of three sizes, either belt or direct connected motor driven;  
fillings of Wagg Steel or stone type, three-part or plain.  
Dusting Machinery of all kinds.

SECOND AND ENLARGED EDITION

# THE PAPERMAKERS' POCKET BOOK

Specially Compiled for

PAPER MILL OPERATIVES, ENGINEERS, CHEMISTS,  
AND OFFICIALS

By JAMES BEVERIDGE

- ☞ This new edition contains more exhaustive chapters on Raw Fibrous Stock, such as Cotton and Linen Rags, Esparto, Bamboo, Megass or Crushed Sugar Cane, etc.
- ☞ The chapter on Wood Cellulose Manufacture by the Soda, Sulphate, and Sulphite methods has been amplified. Very complete information has been given of Soda Recovery, Causticising and Composition of Recovered Soda Liquors.
- ☞ A new but brief chapter has been added relating to Loading Materials.
- ☞ The chapter on Chemical Analysis has been enlarged.
- ☞ It will be found that the additional matter is given in concise form, is of a highly practical nature, and is not generally found in English text books.

PRICE, \$3.50

**BIGGAR-WILSON, LTD., TORONTO**

# "C.B.C." REFINER

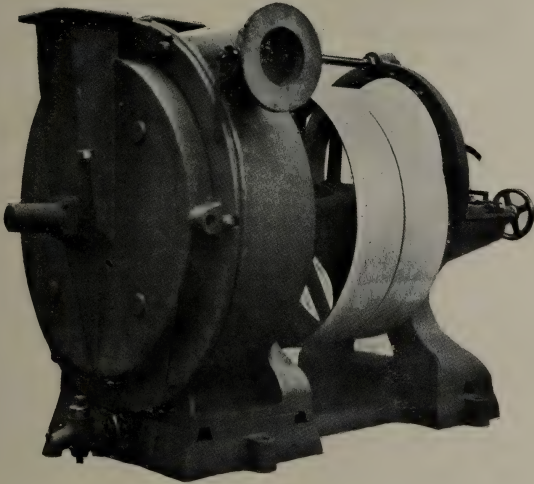

*Great strength and durability.*

*Large working capacity.*

**IT SAVES YOU ALL YOUR SCREENINGS  
i.e., 5 to 10 per cent. of your wood consumption**

**IT INCREASES YOUR PRODUCTION  
5 to 10 per cent. without additional power**

## **The Canadian Böving Co., Limited**

**164 BAY ST.**

- -

**TORONTO**

# THE NORTHERN MILLS COMPANY

**Paper Manufacturers. Printing and Writing Papers.**

Super-Calendered, Velvet and Machine Finished Book, Litho and Antique Printing, Engine Sized Writing and Envelope Papers, White and Tinted Bond. Typewriter Papers (Glazed and Rough Finish). Writing Tablets and Envelopes.

Ask for "Canadian Bond," "Provincial Bond," "Adelia," and "Northern Mills."

**Head Office:**

**Montreal, 278 St. Paul Street.**

**Mills:**

**St. Adele, Que.**

## GENUINE "KRAFT" PAPERS

*Made in Canada*

**THE NEW BRUNSWICK PULP & PAPER CO.**

**Springfield Mills, Millerton, N.B. Limited**

*Ontario Representative - E. H. WILKINSON  
Telephone Building, 82 Adelaide Street West - TORONTO*

## PANZL'S PATENTED LINING COMPOSITION

IS THE SAFEST AND BEST MATERIAL FOR

**LINING OF SULPHITE PULP DIGESTERS**

AND ACID RECLAIMING TANKS

**PANZL LININGS ARE SAFEST AND MOST DURABLE**

They are really acid-proof and practically indestructible.

All Digesters lined with Panzl's patented composition, now as tight and in as good condition after years of continuous use as they ever were, no leaks and no repairs.

Panzl Linings can be made considerably thinner than the other linings, thus increasing the capacity of the digesters

The composition and the system of constructing of Panzl Linings are patented in all countries where wood pulp is being manufactured by the sulphite process. The PANZL U.S. Patents have been adjudicated to be valid in law and wholly independent of all prior patents relating to linings of digesters.

For information and estimates, address:—

**PANZL DIGESTER LINING COMPANY**

**505 Washington Ave., Muskegon, Mich.**

## The Riordon Paper Company, Limited

Fibre, Paper, Lumber.

MONTREAL - CANADA

News Paper, Hanging Paper, Wrapping Paper, Building Paper, Celebrated "Impervious" Spruce Sheathing and Sulphite Fibre for all kinds of Paper.

## THE CANADA COATING MILLS, Ltd.

GEORGETOWN, ONT.



Manufacturers of  
SURFACE COATED BOOK and LITHOGRAPHIC  
PAPERS, COATED CARDBOARD and COATED  
BOXBOARDS of every description.

### "Chalk White" Coated Book Paper.

The best and whitest coated paper sold.

**ALL REGULAR SIZES AND WEIGHTS IN STOCK.**

Our Art Litho Cover Paper is stocked in four tints, 2 sizes. 20 x 25 and 21½ x 28½. Samples gladly sent.

MONTREAL  
TORONTO

**CANADA PAPER Co.**  
LIMITED

WINDSOR  
MILLS, P.O.



# DIRECTORY

of

## Civil and Chemical Engineers

### T. PRINGLE & SON, Limited

Engineers and Architects

Plans and Specifications for Pulp and Paper Mills, Power Plants and other Industrial Works.  
**Coristine Bldg. Continental Life Bldg.**  
**Montreal. Toronto.**  
 Bell Tel.: M. 3890. Tel.: M. 5917.

### R. S. LEA, and H. S. FERGUSON,

ENGINEERS

Pulp, Paper and Chemical Fibre Mills.  
 Water Power Development and Trans-  
 mission. Steam Power Plants.  
 Telephone Long Distance Up. 751.  
 405 DORCHESTER ST. West, MONTREAL

### Arthur D. Little Inc.

— LABORATORY OF —  
 ENGINEERING CHEMISTRY  
 93 BROAD ST., BOSTON, - MASS.  
 Our staff includes experts in Papermaking Chemistry  
 —Sulphite Mill Practice—Fuel Engineering.

### GEORGE F. HARDY, M. AM. SOC., M. E., M. CAN. SOC. C. E.

Consulting Engineer.

Paper, Pulp and Fibre Mills, Examination of  
 Mill Properties, Water Power Developments.  
 Mutual Reserve Building, - 309 Broadway,  
 NEW YORK.

CHARLES E. EATON, JAMES P. BROWNELL,  
 M. Am. Soc., M. E. C. E.

### EATON & BROWNELL,

Consulting Engineers and Architects.

Paper, Pulp and Fiber Mills, Water, Steam and  
 Electric Power Development, Examination of  
 Properties, Consultation Reports.  
 SMITH BLDG. WATERTOWN, N. Y.

ENGINEERS SHOULD WRITE  
 THE PUBLISHERS FOR RATE  
 OF CARDS ON THIS PAGE.

### T. LINSEY CROSSLEY

*Engineering Chemist*

PULP AND PAPER  
 TECHNOLOGY

318 Lagachetiere St., W., Montreal

### R. O. & W. G. SWEZEY

— Civil and —  
 Forest Engineers

Limit cruising, surveys, water storage,  
 power, lumbering contracts.

ME1ROPCLITAN BLDG., QUEBEC

ASSOCIATED WITH

### HERBERT S. KIMBALL

M. Am. Soc. C. E.

Mill Architect and Engineer

111 Devonshire St., Boston

### FOREST ENGINEERS

FOREST SURVEYS LOGGING MAPS  
 WATER POWER TIMBER ESTIMATES WATER STORAGE  
 CLARK, LYFORD & STERLING  
 1331 Real Estate Trust Bldg., Philadelphia  
 CLARK & LYFORD LYFORD, CLARK & LYFORD  
 403 Crown Bldg. 26 Board of Trade Bldg.  
 Vancouver. Montreal.

**PULP** JOSEPH H. WALLACE & CO.  
**PAPER** INDUSTRIAL ENGINEERS.  
**POWER** TEMPLE COURT BLDG. NEW YORK.  
 SALISBURY HOUSE, LONDON, E.C.  
 CABLES, TRIPLEX, N. Y., TRIPLEXIS, LONDON.

**C. B. PRIDE**

**MILL ARCHITECT & ENGINEER**  
**PAPER, FIBER, AND PULP MILLS,**  
**WATER & STEAM POWER DEVELOPMENT**  
 25 YEARS SUCCESSFUL OPERATIONS  
 SPOKANE, WASH. OFFICES APPLETON, WIS.

**J. A. De CEW** M.A. INST. CHEM. ENG. *Chemical Engineer*  
 A.M. CAN. SOC. C.E.  
 Paper Mill Analysis Pulp Testing Investigations  
 Sulphite Fibre, Soda Fibre Reports  
 CANADIAN EXPRESS BUILDING - - - MONTREAL

Power, Lighting, Heating, Ventilating and Drying.—Complete New Plants, Improvement of Old Plants;  
 Plans, Specifications, Contracts, Estimates, Tests, Appraisals, Inspections and Reports.—Pulp, Paper,  
 Box Board and Coating Mills.

Lowest **H. B. PRATHER,** Guaranteed  
 Possible *CONSULTING ENGINEER,* Results.  
 Operating Cost. ROCKFELLER BLDG., CLEVELAND, O.

**HUGH R. BLETHEN**

**21 PARK ROW, - - - NEW YORK, N.Y.**

Traveling Cranes - Overhead Tramways - Trolleys and Chain  
 Hoists for Paper and Pulp Mills - Power Houses.

**Stebbins Engineering & Mfg. Co.**  
**WATERTOWN, N.Y.**

MANUFACTURERS OF  
 STEBBINS' ACID SYSTEMS, SULPHUR BURNER  
 DIGESTER LININGS, RECLAIMERS, ETC.

Engineering Department under Mr. T. L. TOMLINES  
 Plans, Estimates and Specifications for Paper, Pulp and Fibre Mills,  
 Water Power and Hydro-Electric Developments

## LEUNIG PAPER SCALES

Showing correctly at a glance, by weighing a single sheet, the weight of a ream of Paper of any size, containing either 480, 500, or 516 sheets.

Can also be made to indicate in addition to the English weight, the weight in Kilogrammes.

Illustrated Price List on Application.

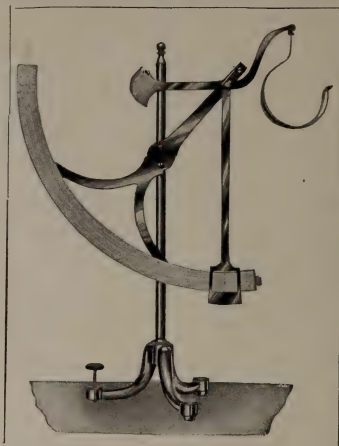

$\frac{1}{2}$  to 80 lbs.

**Price,**  
**Ten Dollars**  
F.O.B., London

$\frac{1}{2}$  to 120 lbs.

**Price,**  
**Fourteen Dollars**  
F.O.B., London

Illustrated Price List on Application.

**Alfred H. Mardon** 150 Shaftesbury Ave. **London, Eng.**

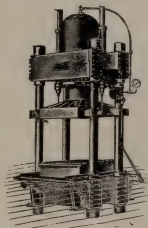

## PULP PRESSES

AND ACCESSORIES

CANADIAN BOOMER & BOSCHERT PRESS  
COMPANY, LIMITED

18 TANSLEY STREET, MONTREAL

"LACHUTE FELTS" Bell Tel. No. 23

## The Hamelin & Ayers Co., Limited

LACHUTE MILLS, P.Q.

MANUFACTURERS OF EVERY DESCRIPTION OF

# FELTS FOR PAPER AND PULP MILLS

"The Best are the Cheapest."

**Q** The Canadian Pulp and Paper Directory for 1912, is now in the hands of the printer.  
*See Page XLVII.*

**The PULP & PAPER TRADING CO.**

TEMPLE COURT BUILDING, NEW YORK CITY.  
DEALERS IN

**Paper and Pulp of All Kinds.**

Prices and Samples on Application.

REGISTERED



JOHN KNIGHT, Pres. C. K. WILLIAMS, Treas. C. H. KNIGHT Sec.

**Paper-Makers Chemical Co.**

FROM MINE TO MILL

**ENGLISH CHINA CLAYS  
MANUFACTURERS**

**Excelsior Felt Cleaner**

GBB Brand China Clay is  
a natural pure white, no artificial tinting Superior Rosin Size  
Unsurpassed for Superior Sat'n White  
coating, bleaching, or fine papers.

**EASTON, PA., U.S.A.**

**The Union Sulphur Company**

Producers of the Highest Grade Brimstone on the Market

Absolutely free from Arsenic, Selenium or Tellurium

**The Largest Sulphur Mine in the World**

**CALCASIEU PARISH, - LOUISIANA**

**Main Offices : Whitehall Bldg., 17 Battery Place  
NEW YORK**

**WE GUARANTEE OUR SIZINGS TO BE ABSOLUTELY CLEAN  
OUR VERA PAPER SIZE**

is purest, strongest and highest free rosin size made. We can furnish you with an ideal rosin size and patented apparatus to use same.

**OUR VERA MILL SIZE**

is the best soluble paper makers' rosin size made. Ready to use in cold or warm water in the ordinary way without apparatus. Gives better satisfaction and is more economical than mill made size.

Our sizings are cleaned by our new patented process and we guarantee this size to be absolutely clean, without the least speck of impurity in the same, preventing thereby black specks in the paper. We are shipping our size in barrels or tank-cars.

**VERA CHEMICAL COMPANY**

Main Office and Western Factory  
NORTH MILWAUKEE, WIS.

Eastern Factory  
STONEHAM, MASS.

**J. R. Walker & Co.**

Importers and  
Packers of

**GRADED RAGS, PAPER STOCK  
ROPE BAGGING, ETC.**

WAREHOUSE, 35 COMMON ST., MONTREAL.

Also Manufacturers of Roofing and Building Papers. Leatherboard and Friction Board

Mills at Sault au Recollet, P.Q.

**ATTERBURY BROTHERS, Incorporated.**

*Importers and Exporters.*

**Wood Pulp, FOREIGN AND DOMESTIC Rags AND Paper Stock**

Potter Building, 145 Nassau Street, New York City.

Cable address "AFFECTIVE," New York.

**CHURCHILL & SIM**

29 CLEMENTS LANE, LONDON, E.C.

And at Manchester

**WOOD PULP AGENTS**

Telegraphic Address:—  
"CHURCHILL, LONDON."

A.B.C. CODE  
5th Edition



# Bertrams Limited

SCIENNES

Edinburgh

- -

Scotland

---

---

*Fast Running Paper Making  
Machines*

*Single Cylinder Machines*

*Bleaching, Washing and Beating  
Engines*

*Improved Refining Engine*

*Motor Driven Centrifugal Pumps*

*Highest Quality Hard Metal  
Screen Plates*

---

---

Full particulars from

**CHAMBERS & SIMPSON**

152 Bay St.

-

Toronto, Ont.

# THE SPLIT BASE PUMP

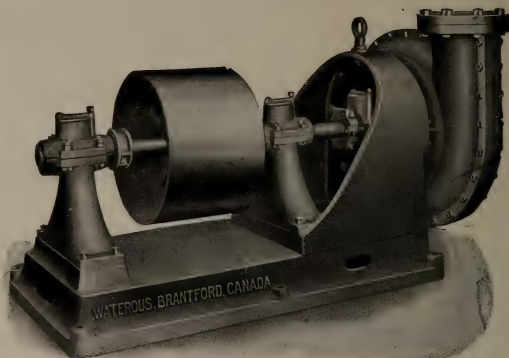

☐ *The split base is an entirely new construction incorporated in our latest design Centrifugal pump. It is of special benefit in pulp and paper mills where lack of space necessitates setting pump suction close to wall. By merely loosening a few bolts all working parts may be removed for overhauling without disturbing pump foundations.*

## OTHER WATEROUS FEATURES

☐ *Split bronze packing gland.—Reversible barrel—Extra long bearings—few parts—solid compact construction—every part readily accessible.*

**Built in Sizes with 4" to 14" discharge. For Belt,  
Engine or Motor Drive.**

☐ *We have installed these pumps in almost every Pulp and Paper Mill in Canada—over twenty in one mill. They are giving the very best of satisfaction.*

THE  
WATEROUS ENGINE WORKS CO.

LIMITED

BRANTFORD,

CANADA.

**Geo. Christie Ltd.** - - - **Glasgow  
Scotland**

**FOURDRINIER MACHINE WIRES**

**Unequaled for Strength, Smoothness and Long Life**

**CYLINDER COVERS**

**Canadian Agent:**

**J. A. Taylor, 22 St. Francois Xavier St., Montreal**

**CANADIAN TALC FILLER**

**GEO. H. GILLESPIE COMPANY**

**MADOC - - - ONTARIO**

*The only Manufacturers of Paper Filler in Canada.*

Our Filler is used in Canada, United States, England, Germany,  
Austria, Holland, Russia and Scandinavia.

**AMBURSEN HYDRAULIC CONSTRUCTION CO.,**

**OF CANADA, LIMITED**

**405 Dorchester St. W. - Montreal.**

*Associated with the Ambursen Hydraulic Construction Co., of Boston, Mass.*

**Concrete Steel Dam**

**OF THE**

**MISSISQUOI PULP CO.,**

**Sheldon, Springs, Vt:**



Mid-channel, height 40 feet.  
Total length 270 feet (only 180  
feet shows in the picture, the  
remainder being concealed at  
the left.)

Dam specially designed to with-  
stand heavy ice gorges.  
Factors of safety, are calculated  
for a 12-foot flood.

**IF YOU HAVE A DAM TO BUILD, WRITE US NOW.**

Every Grade of Waste for  
Paper Making.

# R. HOUGH,

LONDON, England.

Agent for Canada and U.S.,

**THE J. CHRISTIE CO.**

5 King St. West, TORONTO, Canada.

STEAM PUMPS  
CONDENSERS  
VACUUM PUMPS  
TRIPLEX POWER PUMPS  
CENTRIFUGAL PUMPS

The Smart-Turner  
Machine Co., Limited

HAMILTON

CANADA

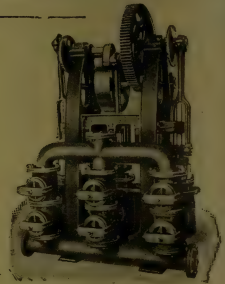

## CRANES

Hoists and Overhead Trolley Systems

Any type, size or capacity. Electric or Hand Power.

NORTHERN CRANE WORKS, Ltd., WALKERVILLE, Ont.



# WINN & HOLLAND, Limited

MONTREAL

PULP AND PAPER CHEMICALS.

Sole Agents for:

**BRUNNER, MOND & CO'S.**

SODA ASH,

BLEACHING POWDER,

SAL SODA,

CAUSTIC SODA, &c.

# PULP AND PAPER MAGAZINE OF CANADA

VOL. 10 TORONTO, JULY, 1912 No. 7

## PRINCIPAL CONTENTS

Conservation of Water Powers  
Selfishness or Caution?  
Recovery of Pulp  
Coated Paper Trade Customs  
Sulphite Slime Waste  
Stamping Press on Machine  
Pulpwood Consumption of Canada  
Forest Re-organization in British  
Columbia  
Dirt in Paper Making  
Hints for Finishing of Paper  
Pulp and Paper Mills, New Incorporations, etc.



# THE JONASSEN PULP REFINER

For the Reclaiming of Ground  
Wood and Sulphite Screenings

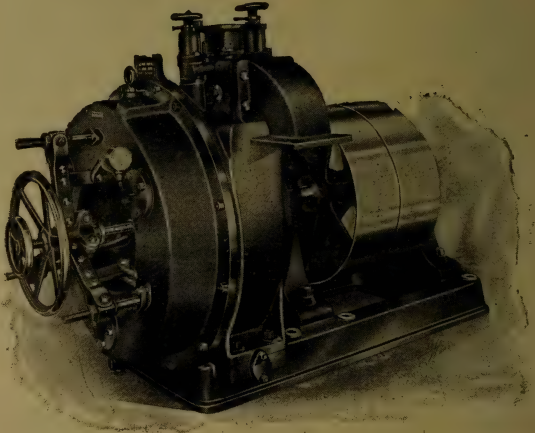

With this Refiner you save all your Ground Wood and Sulphite Tailings or Screenings, which now go to waste.

Capacity of Machine: From 8 to 10 tons of Screenings a day.

Power required to operate same: 20 horse power.

Write us for prices and further information.

## Rice Barton and Fales Machine and Iron Co.

WORCESTER, MASSACHUSETTS, U.S.A.

## EFFICIENCY AND ECONOMY



*in handling materials is a telling factor in the successful operation of every Pulp and Paper Mill.*

No matter in what particular form your material has to be handled, there's a Jeffrey Equipment to meet that condition.

In the accompanying illustration is shown a Jeffrey Rubber Belt Conveyer handling Pulp Laps to a Jeffrey Swing Hammer Shredder.

Correspondence in reference to your conveying problems is invited.

## JEFFREY MANUFACTURING CO.

Canadian Works and Main Office, Montreal

Winnipeg Representatives, - - N. J. Dinneen & Co.

7/7/12

E. J. WELCH, *President and Managing Director*  
HENRY W. S. DOWNS, *Superintendent*

EMMONS CROCKER, *Vice-President*  
A. S. MORSE, *Secretary and Treasurer*

# SCREEN PLATES



The "Union" Bronze (best phosphorized cast metal) Plates for Sulphite Mills. The Standard Rolled Brass Plates. The "Union" Cast Metal Suction Plates.

We carry a large stock of blanks of the various sizes in both metals and can fill all orders promptly.

Old plates reclosed and recut by our process are practically as good as new and give better results than by any other process

**Union Screen Plate Co. of Canada,  
Limited**

**FACTORY : LENNOXVILLE, QUEBEC.**

**OFFICES : Lennoxville, Quebec, and Fitchburg, Massachusetts, U. S. A.**

— THE BEST —  
**JORDON ENGINE**  
 IS BUILT BY THE

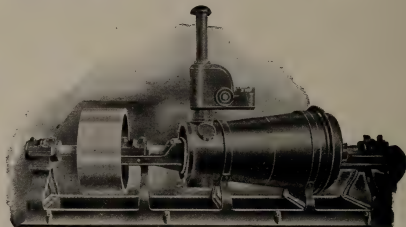

**APPLETON MACHINE CO.**

APPLETON, WIS.

SEND FOR PARTICULARS

**DODGE**

**Transmission** —\*

—\* **Machinery**

— **High Grade Only** —

**Shafting, Hangers, Pulleys,  
 Friction Clutch Pulleys.**

**DODGE MANUFACTURING CO.**

640 ST. PAUL ST.  
 HAYMARKET SQUARE

**MONTREAL** LIMITED

Telegrams :  
"CALENDER, BURY"

Telephone :  
NUMBER 340

# Bentley & Jackson,

Limited

PAPER MAKERS'

.. ENGINEERS ..

BURY, - - ENGLAND

*SPECIALITIES.*

MODERN HIGH SPEED NEWS PAPER  
MAKING MACHINES

SINGLE CYLINDER PAPER MAKING  
MACHINES

The NEW "*MARSHALL*" *PATENT REFINING ENGINE*, with separate adjustment to cones and discs, and our Patent Ball Thrust Bearing.

---

**APPLY FOR PRICES.**

---

# Bertrams Limited

SCIENNES

Edinburgh

- -

Scotland

---

---

*Fast Running Paper Making  
Machines*

*Single Cylinder Machines*

*Bleaching, Washing and Beating  
Engines*

*Improved Refining Engine*

*Motor Driven Centrifugal Pumps*

*Highest Quality Hard Metal  
Screen Plates*

---

---

Full particulars from

**CHAMBERS & SIMPSON**

152 Bay St. - Toronto, Ont.



# J. M. VOITH

Engineering Works and Foundries

HEIDENHEIM °/Brz. - - (Wurt.)

Voith's  
Magazine  
Grinder

Patented in all  
the principal  
countries

Manufactured  
in Canada

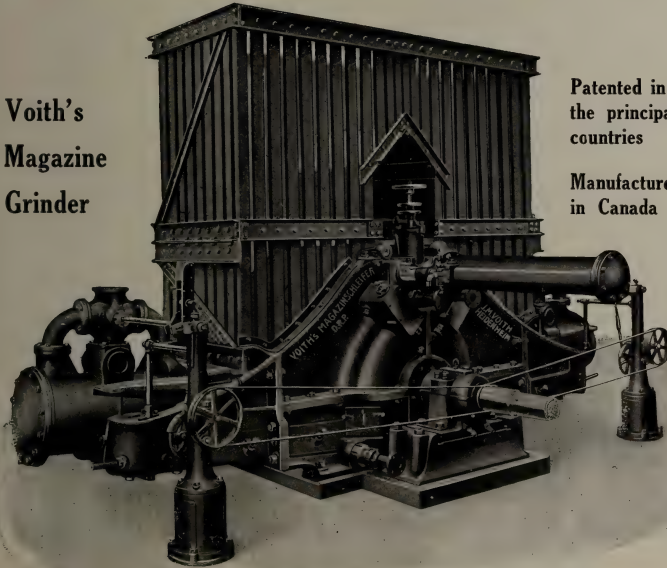

Automatic Feeding and Reversing of Presses. 1 Grinder consumes up to 1200 h.p.  
Of more than 50 apparatus ordered, 25 already delivered  
and working most satisfactorily

SPECIALTIES— COMPLETE MACHINERY FOR  
WOOD PULP, PAPER AND SULPHITE MILLS

Branch Office for Canada and U.S.A. - 1008 Fifth Ave. Bldg., New York  
H. F. STORRER, C.E.

**J. Marx & Co., - - London, E.C., England**

Double Beaters with 1 Basalt Lava Roll and 1 Steel Roll in Concrete Beater Troughs, greatly improve quality of paper, especially News.

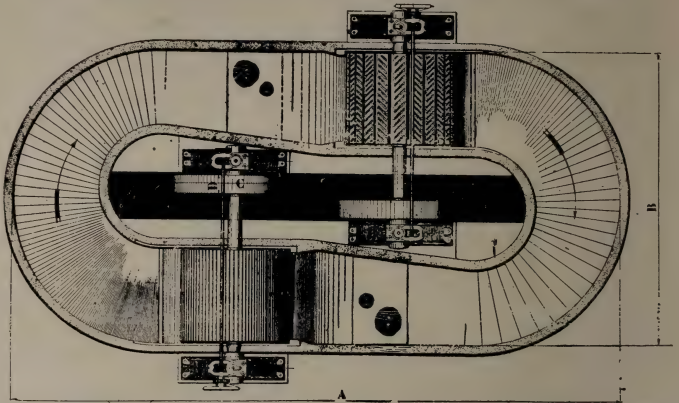

**SPECIALITIES:** Margalt Suction Rolls, Basalt Lava Stone Beater Rolls, Stone Wet Press Rolls, Basalt Lava Pulp Refiners for Screenings.

Canadian  
Representative

**Judson A. DeCew**

Canadian Express  
Building

**Montreal**

*The*

## Harmon Incline Screening System

Will give greatest capacity.

Will give cleaner stock.

Will save power.

Will save labor.

Does not require use of Rakers.

Write us for full descriptive Catalogue and testimonials from the best mills in the country.

# HARMON MACHINE COMPANY

WATERTOWN, N. Y., U. S. A.

OTTO WANDEL  
President

HERBERT H. MILLER  
Treasurer

# Wandel Screen Manufacturing Co.

WALPOLE, MASS., U.S.A.

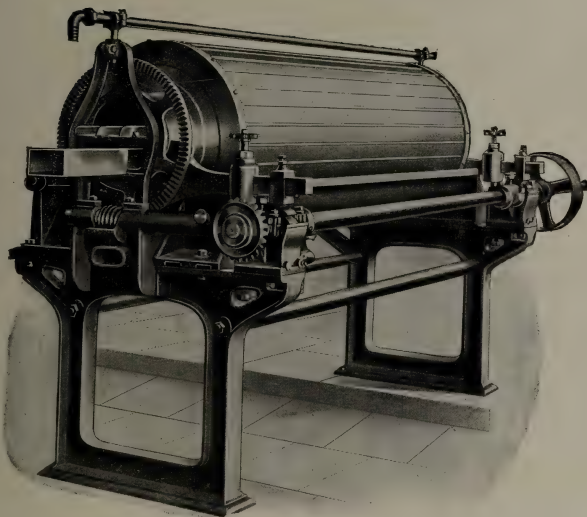

MANUFACTURERS OF THE

Quick Delivery.

Write for Catalogue  
and list of users.

We have no author-  
ized Agents in  
Canada.

# WANDEL ROTARY SCREEN

Over 200 Wandel  
Screens have  
been built and sold  
by us in the States  
within two years.

## SUPERIOR CONSTRUCTION

---

THE SANDY HILL IRON AND BRASS WORKS, HUDSON FALLS, N.Y.

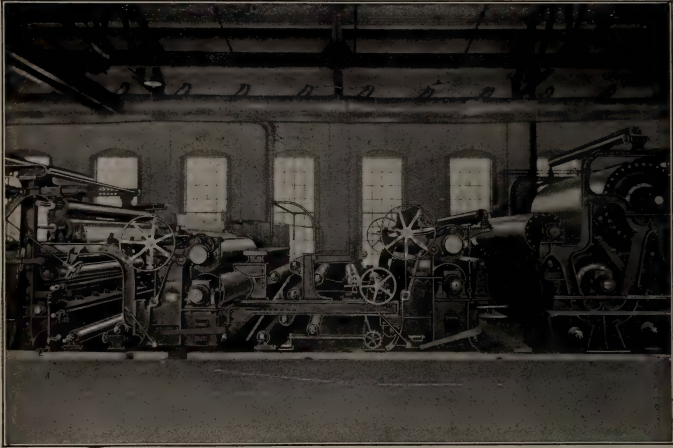

130" HARPER FOURDRINIER PAPER MACHINE

---

The ::

# West End Engine Works Co.

PAPERMAKERS'  
ENGINEERS

- - - EDINBURGH

Specialists in all kinds of  
Papermaking Machinery

Duplex, Angle and Square Cutters, Vickery's Laying Machines,  
Improved Umpherston Beaters, &c., &c.

PRICES ON APPLICATION

Telegrams : West End, Edinburgh

## The Improved "RUTH" Centrifugal Pulp Screen

To suit different conditions the "Ruth" is built as shown in the illustration, or with Steel Mitre Gears in a cast iron casing, independent of the footstep and running in oil, insuring long life of the gears.

It is also built **without gears**, using top pulley or motor drive. In this construction the screen plate sections can quickly be taken out and replaced through side doors.

All parts are easy of access, and no clogging of inlet or plates can take place.

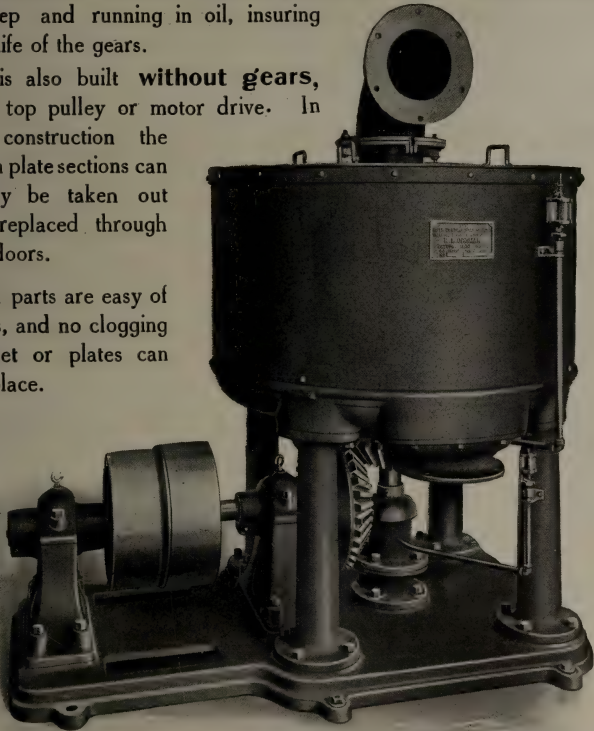

Other prominent features are—

- Simplicity of Construction.
- Small amount of power required.
- Great capacity and Low cost of maintenance.
- Lowest amount of fibre with the tailings.

In these respects this Screen is NOT surpassed by any other Screen in the market.

**P. P. Westbye, M.E., Peterborough, Canada**





**MOVABLE CRANE  
PULP LOG  
STORAGE SYSTEM  
AND UNLOADER**

---

---

**The M. Garland Company**

**BAY CITY, MICHIGAN**

**Inventors of the Cable Conveyer**

# Have You Heard the Facts About The Beloit Machines?

---

---

One Fourdrinier built for 500 feet has run 615 feet, and averages 550 feet and makes 72,000 lbs. of print in 23 hours, 110 inch trim.

Another, built for 350 feet, for manillas, is running 490 feet every day on print.

Two others, built for 250 feet on book, are now speeded up to 340 feet on book.

A cylinder machine built for 40 tons of strawboard has made 89 tons in 23 hours, and averages 76 tons per day, dryers are 116 inch face.

---

---

## Beloit Iron Works

BELOIT, WIS., U.S.A.

# DILLON MACHINE CO

BUILDERS OF

## PAPER MILL MACHINERY

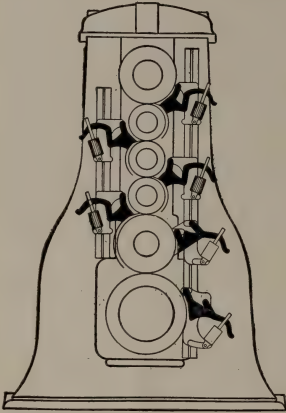

DILLON DOCTORS  
AND FEEDS

DILLON MACHINE CO.  
LAWRENCE MASS.

Beating Engines  
 Washing Engines  
 Jordan's Three Sizes—  
 Single, Double & Triple  
 Stuff Pumps, with  
 Dillon Patent Valve  
 Seating

Brannan Patent Paper  
Folders

Horizontal and Vertical  
Stuff Chests

Single and Double Paper  
Cutters

Backstands

Plates, Knives and Bars

DILLON  
 PATENT  
 DOCTORS  
 AND FEEDS  
 MADE IN  
 CANADA  
 BY THE  
 SHERBROOKE  
 IRON WORKS,  
 SHERBROOKE, P.Q.

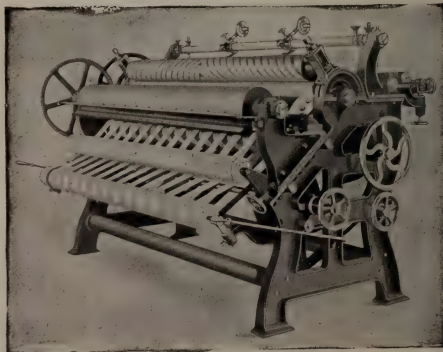

# LAWRENCE, MASS., U.S.A.

---

---

# THE MOORE & WHITE CO.

ENGINEERS, FOUNDERS, MACHINISTS

PAPER MACHINE BUILDERS

Inquiries solicited and given prompt and careful attention.

Specifications and estimates for paper and pulp machinery on either new or repair work cheerfully given

Quality guaranteed strictly high-grade



Office and Works, North Philadelphia Station, P. R. R.  
Philadelphia, U. S. A.

PAPER MACHINES FOR ALL GRADES OF PAPER

ALL GRADES OF BOX BOARDS

ROOFING, FELT AND BUILDING PAPERS

---

SATURATING AND ASPHALT COATING MACHINERY

“M & W” FRICTION CLUTCHES  
AND “M & W” VARIABLE SPEED CHANGES

PRINTING MACHINES  
FOR FLOOR CLOTH AND LINOLEUM

*Bulletins and information on any of the above subjects sent on request.*

---

---

# HOLYOKE MACHINE COMPANY

## HOLYOKE, MASS., U.S.A.

MANUFACTURERS OF

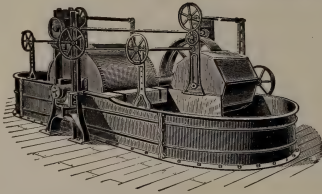

Washing and Beating Engines with  
Patent Double Hoist and Tubs of either  
wood or iron.

Hydraulic Pumps and Presses.

Rag Cutters and Rag Dusters.



Cotton and Paper Rolls with Patent Fastenings.

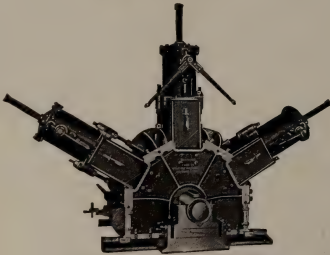

Patent Improved Wood Pulp Grinder.

Elevators, Rotary Fire Pumps and  
Friction Gearing.

Gears Accurately Spaced and Planed.

Shafting, Pulleys and Mill Work.

Machinery for Wood Pulp and  
Paper Mills.

Vertical and Horizontal Water  
Wheels with Flumes and  
all connections.

Wood Barkers, Wood Chippers  
and Wet Machines.

## Newest Designs

AND

## Highest Efficiency

Calenders. All kinds of Super  
Calenders, Friction Calenders  
and Platers.

Chilled Iron Rolls.

Special Machinery

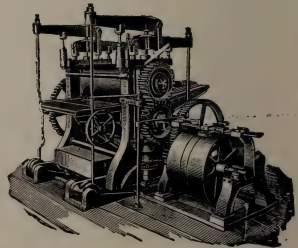

Description and Estimates Furnished; also Gear List  
and Catalogs sent on application.



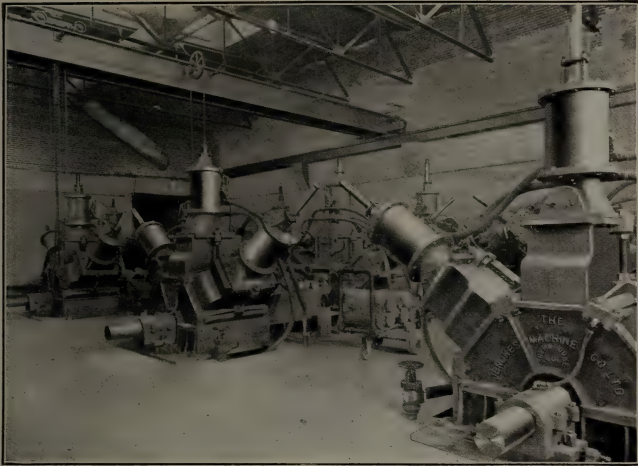

Our latest Model Pulpwood Grinder is of the three pocket hydraulic type, arranged for stones 54 inches diameter, and built in two sizes for 24-inch and 30-inch wood.

*Ask for Bulletins.*

## The Jenckes Machine Co., Ltd.

General Offices: Sherbrooke, Que.

Factories: Sherbrooke, Que., St. Catharines, Ont.

Sales Offices: Sherbrooke      Montreal      St. Catharines  
Porcupine      Cobalt      Rossland      Vancouver

# James Bertram & Son

LIMITED

LEITH WALK

EDINBURGH

- -

SCOTLAND

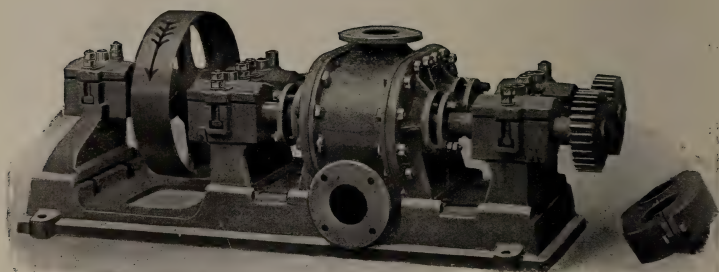

## Rotary Drum Pump

Specially Designed for Paper Making Machines

---

Specialty: Paper Making Machinery

---

Full particulars on application

Telegrams: Bertram, Leith

---

---

# PNEUMATIC

## Save-Alls, Pulp Thickeners and Filters

Remember that we make Special Pneumatic Machinery,  
not only for saving waste from white water but for  
thickening pulp and

*for filtering river water*

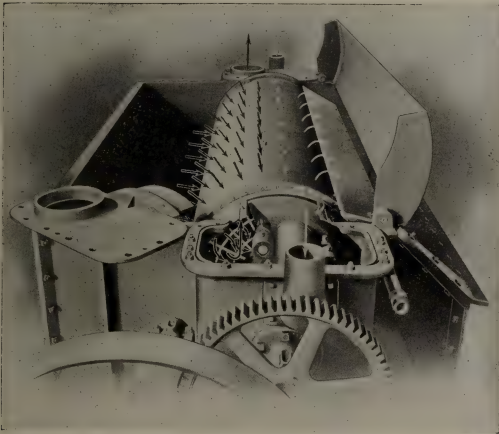

Pneumatic Action of the Save-All

The same pneumatic principle which has made our Pneumatic Save-alls and Pulp thickeners so successful has proved wonderfully effective in our Pneumatic Filter for river water. In this machine we employ an exceedingly fine cylinder-mold facing, through which several million gallons of water per 24 hours can be filtered clean. The clean filtering is due to the minute "mesh" of the covering and the continuous cleansing with air-blast and water-jet; the enormous capacity is due to the pneumatic action; the long life of this Filter is due to the absence of all mechanical wear upon the cylinder.

This machine is filtering clean even in cases where the river is exceptionally dirty because of saw mills located upstream.

*Send for particulars*

---

---

## Sherbrooke Machinery Company

LIMITED

SHERBROOKE

QUEBEC

## RENOLD PATENT SILENT CHAIN

### WHAT USERS THINK

Montreal, Feb. 8, 1909

Messrs. Jones & Glassco, Montreal

RE RENOLD SILENT CHAIN DRIVE.

GENTLEMEN,—In reply to your enquiry of Jan. 30th, I may say that the Renold Silent Chain Drives we have installed are giving every satisfaction.

Our first drive was installed to replace a 12 in. belt which was giving us trouble on account of short centres; this chain has run continuously for four years without the slightest trouble.

Our second drive was installed on a mixing machine doing heavy duty and which had previously broken up two sets of spur gearing; this chain has run over three years with no sign of wear yet.

Our third drive was installed on a calendering machine after breaking two sets of helical gears, and this has been so successful that we are now installing two more similar drives.

I would be perfectly willing to make an appointment with any person genuinely interested and show him the drive in operation.

*The above comes from one of the largest manufacturers in Montreal and is signed by the Mechanical Superintendent. Up to the present (1912) these drives have not received repairs of any kind.*

So satisfactory has their experience been that they are ordering (for a new extension) Renold Chain Drives throughout, transmitting about 400 H.P.

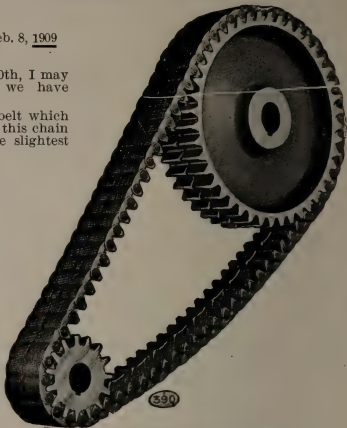

Write for Catalogue.

**JONES & GLASSCO, Sole Canadian Agents MONTREAL**

REGISTERED

# Lawrence Machine Co.

LAWRENCE

MASS.

— MANUFACTURERS OF —

## Lawrence Centrifugal Pumps

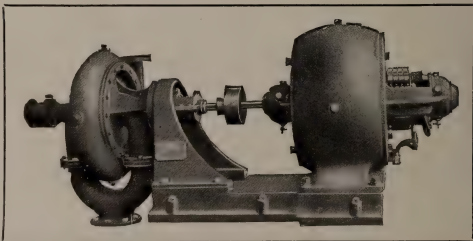

LET US FIGURE ON YOUR REQUIREMENTS

## THE LITTLE CHUTE PULP CO.

MILLS AT BUCHANAN, WIS.  
DAILY CAPACITY 50 TONS

LITTLE CHUTE, WIS.,

Mr. J. H. Taylor, V. P.

March 31, 1909.

McCartney National Bank,

Green Bay, Wis.

Dear Sir:

Answering your inquiry of the 30th inst. with reference to New Barker Machine, made by the Green Bay Foundry & Machine Works of Green Bay, will say, we installed one of their barkers in our mill here on a 60 days' trial with guarantee as to its saving of wood and cordage with the old style of barkers. During the 60 days trial, we gave this barker a most thorough and severe test, covering the parts named in their guarantee, and have decided that the machine will do all that is claimed for it, in the saving of wood and in amount barked.

We feel sure that the machine will pay for itself in less than 6 months' time. On Spruce wood it has no equal that we know of.

We have bought the machine put in on trial and ordered one additional machine to be delivered as soon as possible, for our mill here, also ordered one machine for the Outagamie Paper Company at Kaukauna.

Mr. J. C. Kimberly and Mr. Peter Thom, after looking into the merits of the machine here, tell me, they have ordered one machine for their mill at Kimberly and two for Quinnesec.

Any further information you may want; we will be very glad to give it.

Very truly yours,

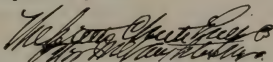

**THE GREEN BAY BARKER CO.**  
GREEN BAY, WIS.



**WALM**  
**High-speed Paper**



175 INCHES

**MAKING PAPER**

**600 FEET PER**

*without Friction Clutch*

**CHARLES WALM**  
**BURY, LA**

*Estimates Given for Complete Paper-Making Plants.*

Sole Agents for Canada: C. H. JOHNSON &

# SLEY'S

## making Machines

VIDE ARE

ER AT OVER

ER MINUTE

*es or Gear Wheels*

# SLEY & CO., LTD.

## NCASHIRE

Codes : McNeill's (1908 Edition) Western Union, Bedford  
McNeill's A. B. C. 5th Edition

Cables : Pumps, Bury

NS, LTD. - ST. HENRY, MONTREAL

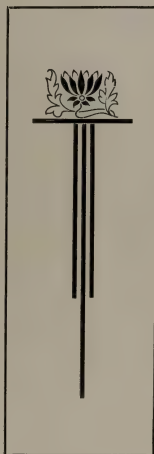

# Wilson-Paterson Co'y



127 BOARD OF TRADE BLDG., MONTREAL.

Agents for the United Alkali Co. of England

## ***OFFER TO THE TRADE:***

Caustic Soda 60° to 78° Soda Ash, Caustic Potash, Sal Soda, Silicate of Soda, China Clay, Rosin size and a full line of Rosins, direct shipment from the south.

**Contracts made for regular supplies.**

# PARSONS TRADING COMPANY

*Exporters of Paper to all Parts of the World*

WHITEHALL BLDG., 17 BATTERY PLACE, NEW YORK

BRANCH OFFICES AT

LONDON      SYDNEY      MELBOURNE      WELLINGTON      CAPE TOWN;  
BOMBAY      HAVANA      MEXICO, D.F.      BUENOS AIRES

**CORRESPONDENCE WITH MILLS SOLICITED**

# THE CARTHAGE CHIPPER

WILL INCREASE YOUR CHIPS. WILL  
DECREASE YOUR SAWDUST. By virtue  
of its Design and its Patent Feed Spout it takes a  
MINIMUM AMOUNT OF POWER.

---

Ask Anglo- Newfoundland Development Co.  
Ask Laurentide Pulp and Paper Company.  
Ask The Riordon Paper Company, Limited.

---

OR WRITE

**CARTHAGE MACHINE CO.**  
**CARTHAGE, N.Y.**

# Pulp and Paper Magazine of Canada

*A Magazine devoted to the interests of Canadian Pulp  
and Paper Manufacturers and the Paper Trade.*

SUBSCRIPTION PRICE; \$2.00 a year. Single Copies, 20 cents.

The pulp and Paper Magazine is published on the second Tuesday of each month. Changes of advertisements should be in the publishers' hands not later than the 1st of the month, and where proofs are required, four days earlier. Cuts should be sent by mail, not by express.

PUBLISHERS:

BIGGAR-WILSON, LIMITED, : Confederation Life Building, Toronto, Canada

---

---

## *Conservation of Water Power*

---

Next to the possession of almost unlimited pulpwood areas, Canada's greatest asset for making her the foremost pulp and paper manufacturing country of the world is her numerous and magnificent water powers. The Conservation Commission recently issued a report which shows that the total water power developed in Canada in 1910 amounted to 1,016,520 horse power, of which 532,000 was in Ontario. Referring to the Ottawa power district, the opinion is expressed that under a system of canals and storage, its capacity could be made not less than 1,000,000 horse power, and the same estimate is made of the possibilities of the St. Lawrence. Quebec is, perhaps, the richest territory in the world in respect to potential water powers, 80 per cent. of the total energy used in that Province being water power. In New Brunswick, development has not proceeded very far. Navigation and lumber driving interests cannot be interfered with, and another handicap is that there are but few lakes which can be used as reservoirs for storage. Nova Scotia pos-

sesses some small powers, which, however, are well adapted for economic purposes.

Mr. R. O. Sweezey, a valued correspondent of the magazine in Quebec, who has done a large amount of exploration work in the timbered districts of that Province, commenting on the report of the Commission, states that while undoubtedly a valuable contribution to the subject, it does not give an accurate idea of the water powers of Quebec Province. His chief criticism is that the estimated totals given are much lower than they should be; which, perhaps, is a more creditable fault than a bombastic estimate in the opposite direction. The error which is alleged arises from the fact that the amount of water power capable of being developed has been estimated in each case for a head equal to the natural fall, whereas in practically every case it can be materially increased by the building of dams, or head works. There are natural conditions also on almost every river by which storage could be carried on on a very large scale. In

many cases, water powers could develop at least twice as much horse power as is credited to them in the report. Mr. Sweezy knows of many powers, some of them ranging from a few hundred up to a few thousand horse power, which are not included in the report at all. It should be remembered, however, that this is the first report on this subject which has ever been issued, and some incompleteness may naturally be looked for. It is undoubtedly a useful step in the right direction.

It has been calculated that no less than 5,000,000 tons of paper might be made annually from the forest areas of Quebec Province. There are dozens of water powers of less or greater magnitude situated in the Saguenay, Ottawa and St. Maurice River districts, also along the north shore of the St. Lawrence, and near the Ste. Anne and Jacques Cartier Rivers, which offer an almost unlimited opportunity for the manufacture of pulp and paper. The wood and the power are both there in astonishing proximity and convenience for development, and it only remains for the energy which has characterized the past few years to continue in order to bring the above prophecy to pass.

---

### SELFISHNESS OR CAUTION?

---

Our able New York contemporary, the Paper Trade Journal, takes the statistics of pulp and pulpwood production recently issued by the Dominion Forest Branch, and an abstract of which appears in this issue, as the text for a little homily against the selfishness of Canadians protesting against the export of wood in an unmanufactured condition. The cut of pulpwood, it will be seen, was approximately 1,520,000 cords, of which no fewer than 847,900 cords were exported out of Canada. Either this cut will have to be increased or, as the Journal admits, the export will diminish, when

all the big pulp and paper plants on this side are in full operation. "But," it goes on to say, "all the Canadian mills, even with the fullest of their new equipment in active operation, could not begin to supply the United States demand for paper, so that if the patriotic, though selfish, idea of some Canadians, were to be put into practice, the commerce of the Dominion would necessarily suffer."

It is quite true, as this writer says, that under the conditions which prevailed last year, with not enough mills in Canada to make use of the surplus 847,000 cords of wood, Canada would have lost the profit on that quantity of wood. But look at the smallness of that profit and compare it with what it might be. And does not the Journal believe that there is a very intimate connection between the prohibitory legislation of Quebec, for example, and the large increase in new mills which are now either just getting into operation or are in course of construction in that Province?

But that is just the point. With hundreds of thousands of cords of pulpwood going out of the country to help build up the pulp and paper industry of another country, there was not sufficient incentive, seemingly, for United States and other paper manufacturers to build mills in this country. In the end, perhaps, economic and transportation conditions would have been sufficient to draw them, but in the meantime Canada's resources would have been going in the same direction as those of the United States, and though Canada has sufficient pulpwood in the aggregate, to last both Canada and the United States mills for unnumbered years, yet it must be remembered that the percentage of readily accessible wood was being eaten up quickly enough to render a "halt" advisable. Our contemporary admits that conservation is a good thing. It should also admit that the time for conservation is when we still possess the resources to be conserved.



## EDITORIAL COMMENT.

At an important trade organization meeting in London, recently, the opinion was expressed by the President, who is also a judge, that "trade-marks are the curse of fraudulent traders and the natural bond between character and success; they put a higher premium upon commercial honesty than anything else." There is good plain sense in this opinion. Trade-marks are a protection, both for the manufacturer and consumer. For the former, they mean that he can go ahead building up a reputation in the knowledge that it will redound to his own benefit. The consumer is equally benefited because he can always ask for a product which past experience teaches him to be good and according to representation, and just what he needs. The successful manufactures of the future will be largely such as are indelibly connected with the maker's name, through a trade-mark.

\* \* \* \*

Librarians both in Canada and the United States are making an outcry at the short duration of the paper of which newspapers are made. Newspaper files of less than forty years old, they declare, are discolored and worm-eaten to such an extent as to make them worthless as records of historical fact or current information. All sorts of suggestions have been made to remedy the trouble. One is that each newspaper should print say a dozen copies on superior rag paper; another that two special library copies should be run off, one of which would be hermetically sealed and not opened until the first should have perished. Still another idea is to dip a given number of copies in a certain chemical solution, but as the process would, it is said, cost something like \$25 per copy, it seems to be out of the question. While it is true that an occasional newspaper may contain information worth \$25 to some future historian, it is also true that it would be difficult at the proper time—the day

of publication—to differentiate between the valuable ones and those not worth as many mills. Many newspapers have good quality, but it is a case where quality is smothered up in quantity. The Sunday newspaper, for instance, is responsible for a good deal of "quantity."

## RECOVERY OF PULP.

J. M. Burby, of Astoria, N. Y., has invented a process for recovering pulp from waste news print and other papers in such a form as to enable it to be used again in manufacturing similar grades. Heretofore, the processes or re-agents employed have tended to discolor the pulp. The process is based upon Mr. Burby's discovery that borax in solution does not produce a discoloration of the fibres of the mechanical wood pulp, and does not perceptibly affect their other physical properties, when such waste papers are subjected to its action at high temperatures, or are boiled therein, or even if the borax solution be stronger than required to dissolve or saponify the adhesive ingredients of printers' ink and the cohesive ingredients of the sizing employed in the manufacture of such papers. His experiments have demonstrated that if such waste "newsprint" papers are boiled in, or subjected under a correspondingly high temperature to the action of, a solution, containing approximately two pounds of borax in 1,000 pounds of water, the oily and resinous ingredients of the printers' ink, and the cohesive ingredients of the sizing, are liquified and saponified sufficiently to enable the fibres of the pulp to be separated therefrom, and that even a more concentrated solution of borax may be used in this way, without producing the discoloring, or any other detrimental effect upon the fibres of the mechanical wood pulp contained in the waste papers thus treated. The waste papers may be thus treated before being pulped or after having been pulped; the most practical method is, however, to use the borax solution in the beating engine. If the waste papers are to be treated with the borax solution after having been pulped in the beating engine, the quantity of

water contained in the pulped material, must be taken in consideration in determining the quantity and the initial strength of the borax solution to be added thereto.

The most practical way of conducting the process of recovering pulp from waste news print and from other grades of paper, containing mechanical wood pulp, according to this invention, is as follows: A quantity of the borax solution, heated to near its boiling point, is filled into the tank of the beating engine, the beating engine is started, and the waste papers, after having been dusted and roughly separated, are successively thrown in. A further supply of the borax solution and of the waste papers are successively added until the tank is filled to the full capacity of the beating engine. To secure the best results, about 15,000 pounds of the solution should be used for every 1,000 pounds of dry weight of the waste papers to be pulped in the beating engine and the initial strength of the solution should be somewhat in excess of the stated standard (2 pounds of dry weight of borax to 1,000 pounds of water) because the borax, contained therein, is quite rapidly being consumed in saponifying the oily ingredients of the ink, which are first acted upon by the solution. The action upon the cohesive ingredients of the sizing takes place later, that is, when the waste papers have become thoroughly permeated by the solution. The initial consumption of borax amounts to about 11 per cent., and is greater, if less than 15,000 pounds of the solution is used for each 1,000 pounds of the waste paper stock.

By the time the waste papers are thoroughly pulped, all cohesive ingredients of the printers' ink and of the sizing are dissolved or liquified, and the insoluble impurities, like the pigments of the ink, clay or other filler and the like, are commingled with the pulp fibres. The pulped material is then discharged from the beating engine into a chest, the liquid drained off, as far as is practicable to be done without pressing, and the pulped material washed with fresh water. This washing can be done in the chest, if the chest is provided with some mechanical

device for agitating the pulped material and disposes of the borax solution, and of the dissolved or liquefied ingredients of the ink and of the sizing, remaining in the pulped material after drainage. It is better to employ a mechanical agitator in the chest to save the handling of the material. The washed material is then conveyed upon screens, or other suitable apparatus, where the insoluble impurities, like printers' ink, clay, filler, etc., are separated from the pulp fibres and the latter collected.

Instead of pulping the waste papers in the borax solution, they may be subjected to its action after having been pulped in the beating engine. In such a case the pulped material is conveyed from the beating engine into a chest, provided with a mechanical agitator, the solution, in quantity and strength to be determined upon consideration of the quantity of water contained in the pulped material, is added thereto, and the mechanical agitator set in action. The chest should be provided with means for heating the solution and the pulped material, and the heating and agitating of it should be continued for about one hour or less. Then the liquor is drained off, as much as it can be, the pulped material washed with fresh water and conveyed upon screens, where it is treated in the same way as explained above, to separate the pulp fibres from the impurities.

---

#### COATED PAPER TRADE CUSTOMS.

---

The following resume of trade customs as revised and adopted by the coated paper division of the American Paper and Pulp Association will be of interest to Canadian manufacturers.

1. Terms of all sales to be on a basis of cash within thirty days from average date of monthly invoices less a discount not exceeding 3 per cent.

2. Minimum basis of weight for coated book (coated two sides) to be 25x38-70 to 500 sheets. For lighter weight extra cost of manufacture to be added estimated at not less than 5 cents per 100 pounds for every pound or fraction thereof below the minimum.

3. Minimum basis of weight for coated lithograph and label (coated one side) to be 25x38-60 to 500 sheets. For lighter weight extra cost of manufacture to be added estimated at not less than 5 cents per 100 pounds for every pound or fraction thereof below the minimum.

4. An additional price of not less than one-half cent per pound shall be charged for all making orders of less than 5,000 pounds one size and weight.

5. All papers shall be stenciled and billed at the ordered weight per ream where variation is not in excess of 5 per cent. above or below. Paper within these limits to constitute a good delivery. All paper in excess of 5 per cent. under the ordered weight shall be stenciled at its actual weight and be charged accordingly if accepted.

6. In all cases of both sheet and roll orders, case linings, wrappers, and twine shall constitute a part of the ream weight of the paper not exceeding 2 per cent.

7. Special making orders shall be accepted subject to over runs as follows:

Under 2½ tons .....	20 per cent
2½ to 5 tons .....	15 per cent
5 to 10 tons .....	10 per cent
Over 10 tons .....	5 per cent

8. No printed waste to be returned, and no paper taken back unless damaged before delivery.

In case customer desires to make claim for damaged paper, report must be made immediately to the manufacturer, in order that the paper may be inspected before it is printed or cut.

9. For all paper of any shade other than white or light natural the extra cost thereof estimated at not less than 50 cents per 100 pounds shall be added to the base selling price (coated one or two sides).

10. For wrapping and sealing in packages the extra cost thereof estimated at not less than 10 cents per 100 pounds shall be added to the base selling price.

## DAMPING PAPER ON MACHINE.

The question is often raised whether to damp paper on the machine before reeling or afterwards by means of some device made especially for the purpose. We are told by "Wochenblatt" that in most German mills the paper is slit on leaving the machine and is reeled up on spar drums. If the distance between the slitting knives and the reeling drums be too great the tension cannot be kept sufficiently taut, and in such cases damping on the machine is liable to cause the reels to run askew. This, however, is no argument against damping on the machine, since it is easily remedied by proper regulation of the distances. No doubt a separate damping machine possesses certain advantages, especially for fine papers, but uniform working, followed by uniform glazing, can only be insured if the reels of paper have been thoroughly cooled before damping. If the paper is still warm the moisture is absorbed irregularly, and trouble is likely to arise just as much as if the damping were done on the paper machine. However carefully the paper machine be attended, it is never possible to dry a reel of paper evenly; there are innumerable stages between the conditions of "just dry," "hot-dry," and "over-baked," which cause irregularities in damping unless the paper be first cooled. For instance, when a break occurs, cylinders become overheated unless the steam is turned off at the same moment.

The trouble and expense of a special damping machine may be avoided if the paper machine be provided with a large and efficient cooling roll, so that the paper may be cooled before damping. Improvements in the design of cooling rolls have not kept pace with improvements in paper machines of recent years and their increased speeds. Many paper machines are run without any cooling roll at all, while in others the cooling surface is altogether inadequate, being provided by a roll 10 to 16 inches in diameter, with which the paper comes in contact over only one-half or two-thirds of its circumference. Such rolls cannot possibly cool the paper sufficiently to insure the moisture of the

The Jonquiere Pulp Co., who are installing three 156-inch paper machines expect to have same in operation by October the 1st, with a total capacity of 150 tons a day.

damper being evenly distributed, and they are a fertile source of trouble owing to the paper sticking to the surface and winding round the roll. The writer gives his views as to what a properly constructed cooling roll should be in order that its presence should prove a real benefit to the manufacturer. It should have a diameter of at least 39 to 46 inches and should be constructed of cast iron with a shell of copper. It is absolutely essential on fast machines that a doctor should be fitted to prevent the paper winding round the cylinder, and a plain copper shell without a cast iron support will not stand the pressure of a doctor. A sufficient flow of cold water in side must be provided, and the paper should be pressed in contact with the cylinder by means of a woolen felt. Some mills have so far recognized the importance of cooling the paper that they have fitted up the last drying cylinder as a cooling roll, supplying it with cold water instead of steam. The advantage is felt not merely with damped and supercalendered papers, but also in the case of rough or machine finished papers, since the cooling roll removes the electricity from the paper; it also enables the machine man to judge his weights more accurately, since irregular drying means irregular weights.

#### ELECTRIC POWER IN PAPER MILLS.

A writer in an electrical magazine, the "Magnet," gives an idea of what he styles the "difficulties" to be overcome in converting paper manufacturers to the use of electricity in their mills.

With regard to choice of system in a new plant, the writer considers the choice, especially for mechanical mills, as easy. The process is a continuous one and the motors are required to run at constant speed. The power installation will nearly always be on the alternating system, with an extensive use of squirrel-cage motors. The choice is difficult, however, in all plants which have to be converted from steam. Most of the processes are intermittent and if the plant is small the necessity of running the machines with a wide range of speed to make them suitable for

a variety of kinds of paper will weigh in favour of continuous current. In selecting voltage, consideration must always be given to local conditions. If the plant is new with ample provision for safety, high voltage motors may be used, especially if the power is transmitted from a distance. In converted plants, where motors have to be fitted into badly arranged places with walls and floors soaking in water, it is advisable to use as low voltage as possible. Generally speaking, 230 volts would be found quite suitable.

In the preparation of mechanical wood pulp the grinding wheel absorbs from 300 to 400 h.p. according to the number of cylinders working. On account of the occasional heavy demands of power, poly-phase current supply is to be recommended, induction motors being coupled to the wheels by means of flexible couplings. The motors are of the slip ring type, as considerable power is required to start up the stones from rest. The driving of the refiners requires also a heavy starting torque at the commencement of the process, the motors are all fitted with slip rings, without adjustment of speed; the power required is about 20 h.p. each and the drive is by belt. The motors should always be placed outside in separate houses, or, where this is not possible, totally enclosed to obviate the ill-effects of the damp rooms. In most of these machines direct drives are recommended, the motions being fairly fast, and, except in the cases where heavy starting torques are required, squirrel-cage motors (started by means of compensators) will be found satisfactory.

In the preparation of chemical wood pulp (sulphite and soda) it is pointed out that besides the same mechanical appliances (cross saw, barking machines, conveyors, etc.), a chipping machine and disintegrator are employed. The driving of the disintegrators is a heavy load for the motors, owing to the continuous heavy vibration whenever small lumps of wood are caught between the stationary and revolving pins and broken up by the impact. It is always advisable, he says, to couple this kind of machine to the motor by means of a long belt or ropes, to insure flexibility. The horse power required by



the disintegrator is 60 to 80, and the speed for the motors should be 600 to 750 revolutions a minute.

In the event of a non-flexible or rigid coupling being decided upon for either of these machines, care should be taken to have a very strong emergency end-thrust bearing fitted to the motor in case of breakage of the disintegrator shaft. For the digesters (sometimes spherical boilers) which rotate slowly, the drive can be obtained only by worm gearing, but as the process lasts from 16 to 18 hours the gearing should be rated for continuous work, as the straining of one of the worms might upset and disturb the production of the whole mill. With stationary boilers, the only power required is for the centrifugal circulating pumps. In the next process, the cylindrical disintegrator for breaking up the boiled wood is driven by a machine (35 to 50 h.p.) the drive of which is best obtained by means of a long belt, but the motors will have to be of the slow speed type (375 r.p.m.) as the disintegrator itself does not run more than 120 r.p.m. For the pumping of the fluid pulp through the sand traps and the straining and pressing into a web of paper, only simple mechanical drives are necessary. In the case of the pump the motors are coupled direct to the shaft, and to the press plate by means of a belt or chain.

In the case of mills manufacturing paper from rags or esparto the beaters and cutters might be worked by coupling 5 to 20 h.p. motors direct to the machines, but the coupling should be flexible to prevent transmission of shock when a chance piece of hard or horny substance is met. The motors in this kind of plant would be mostly of the continuous current type, constructed to slow down whenever a heavy load is put on the machine. After the rags have been passed through a belt-driven dusting machine (3 to 5 h.p.) they are conveyed by means of blowers (10 to 12 h.p. direct coupled) to the boilers and thence to the washing-engines. These engines absorb usually about 30 h.p., the largest size reaching 55 to 60 h.p. The speed being almost 200 r.p.m., a direct drive is not advisable, but a reasonable direct drive may be obtained by using a

reduction of 1 to 3. The perforated drum which removes the dirty water is usually operated by means of a gear from the main shaft of the engine. The product of the washing engine is a liquid pulp from which the paper pulp is extracted and compressed into "half stuff" if required. For this 5 h.p. is needed. In most mills, however, it is usual to continue the process by conveying this pulp to the paper machine. The motors used in all these wet processes should be protected from water-splashes. In rooms where the stuff is treated with chemicals, or where chemicals are recovered, totally enclosed and gas-tight motors should be employed only, care being taken that the rating is ample, for the temperature in these rooms is very high because of the large amount of steam used. The switch gear should also be gas-tight, and all fittings used in the internal installation should be of the water-tight pattern. All earth connections, both for motors and switchgear, should be very heavy. It should not be forgotten that the wet condition of the floors in these rooms predispose the slightest shock to producing dangerous consequences, a case being recorded of a man being killed by coming in contact with an 80-volt continuous current.

Coming to paper machines proper the electrical expert states that whether worked on the continuous wire screen or the cylindrical screen principle, these machines are usually driven by two independent motors,—one for the wet and the other for the dry section. That part of the paper machine which takes the paper from the breast box onwards must run at variable speed. In order to keep the same thickness of paper all through, the regulation of the motor must be very fine. Samples of the paper are taken continuously to test this uniformity and sometimes the speed has to be increased by fractions of 1 per cent. It is in this department that the principal advantages of electric driving are to be found, as it is possible to insure a finer and more even regulation than with the speed reduction gears applied to the steam engine. The range of regulation is governed by the qualities of paper produced at any time



by a given machine in a small factory with only one machine it will have to be much larger than in a large factory where two or three machines are kept working side by side, and where the production can be split up between the three.

For a continuous current installation, three alternative methods are discussed: (1) paper machines requiring a regulation not exceeding 1 to 3.5, (2) machines requiring a regulation of 1 to 5.5, and, (3) machines with a speed limit of 1 to 10 or 1 to 20. The first, being used mainly for news and common quality paper, may have motors of the ordinary type with regulation in the field system. The second, employed for a larger variety of papers of practically the same class, can also be fitted with a motor made for direct regulation by a resistance in the shunt winding, but must also be fitted with a compensating winding in the main poles, to neutralize the armature reaction. The third type of machine is used for good writing paper.

#### DIRT IN PAPER MAKING.

In order to find the cause of impurities in paper the spots themselves must first be carefully investigated. Generally one thinks of removing dirt only in the bleached half-stuff. One should however, consider purity more when storing, cutting, and boiling the rags. Cases have been observed in which papers made of good and expensive rags could be manufactured at a lower price than if they had been made of cheaper rags, because in the case of the latter the yield was less and the waste, in consequence of impurity, greater. New white rags should be washed with washing drums; when rapid, intense washing is important, however, washing screens will be retained. In order to avoid unnecessary loss of pulp, the washing screens must, of course, be stopped at the right time when beating continuously. When the rags are boiled they must be thoroughly mixed with the liquor before steam is admitted, and the temperature of the steam should not rise above 160 degrees C. The crust of dirt which settles in the boiler must be regularly removed. In boilers protected

from the radiation of heat care must be taken that pieces of the insulation do not get into the boiled material. In order to keep leather, india rubber and the like out of the rags it is preferable to give the rag sorters a bonus for sorting out these substances. For separating buttons, metal, sand, etc., the half-stuff should be allowed to flow slowly before being bleached over a broad sand trap. During bleaching the chloride of lime solution will be filtered by a gravel filter and the sulphuric acid through glass wool. In drain chests it can frequently be observed that the bottom layer has become soiled. This is partly due to the outlet ports being too small, so that liquid is dammed up therein and returns from the ports into the chests. In the event of the drain chests not being surmounted by an arch it is preferable to coat all iron parts over them for avoiding rust, or water which has contacted therewith, passing into the pulp. When the half stuff is removed from the drain chests scoops of tinned copper and not of steel should be employed. The hollandier engines must be thoroughly cleaned from time to time, the rolls of the whole stuff hollandiers being inspected as to whether or not stuff has jammed between the knives. The dome should be made readily removable and lined with sheet copper. Likewise it is preferable to cover the paddle with copper. The vats or tubs into which the pulp is conveyed from the hollandier engines must not be placed on the ground, but on a clean bench. Empty vats must not be placed one in another. Belts from which dirt might fly into the pulp must be covered over. The brays of the edge runners must be carefully lubricated. The rosin deposited on the bushes and scrapers of the edge runners when cellulose is passed through them must be removed at regular intervals. The mill water must be not only mechanically cleaned, but also liberated from the iron dissolved in it. The water for the hollandier engines for making size, etc., should be sent through filtering bags in addition. All pipes at the paper machine must be laid from the first so that they can be readily cleaned. Particularly the pipes for the waste water from the strainers and also

from the sand traps and knot strainers, etc., must be cleaned every Sunday. Sharp bends are to be avoided in the pulp pipes, and the inside diameter of the packing rings must exactly equal the internal diameter of the pipes. In the case of fine papers it is preferable not to recover the water from the suction apparatus, because it would afford a further possibility for the formation of blur.

The raw material must, of course, be carefully tested. To this end cellulose is moistened and observed with light falling through it. When old paper is employed for expensive kinds special care should be taken. Suitable receptacles should be placed ready for waste, both from the paper machine and also from the cross cutters and calenders. The waste from the finishing room must be carefully examined beforehand in the event of its being employed for fine papers. Bought paper shavings are preferably employed only for mean paper. In mills which make various kinds of papers care as to a suitable order in sorting must be taken. The neighborhood of other industries is not desirable for the manufacture of fine paper, because the purity of the paper is endangered by the production of dust and soot. In fine paper mills the boiler house must be located in the direction from which the wind most rarely comes. During dry weather the yards and roads of the mill must be regularly watered. Cleanliness of the workers is to be generally encouraged by means of bright, spacious workrooms, lavatories, etc.

---

#### HISTORY OF THE PAPER MACHINE.

The idea of making paper by pouring a pulpy paste on to an endless running wire was undoubtedly due to Nicholas Louis Robert, who was born on December 2nd, 1761, in Paris. He there attended the school of the Franciscans, and afterwards was articled to a notary. When eighteen and a half years old he became a soldier and fifteen months later was a volunteer in the regiment "Metz-Artillerie," which went to the aid of the English Colonies fighting for their independence in North America. In the second year of the Re-

public we see him again in Paris as proof-reader in the printing works of Pierre Francois Didot, jun. The latter recommended him to his son Didot Saint Leger, who appointed him foreman (*inspecteur des ouvrieres*) in his paper-mill at Essones, near Corbeil. He frequently had difficulties and trouble with the workers (about 300 men) here who, of course, were full of the ideas and events of the time. He then hit on the idea of building a machine which could make paper with the aid of only a few hands. His chief, Leger-Didot, willingly placed his workshop and the necessary material at his disposal and he first built a small model of his machine. After five years he had made in his spare time a large model on the basis of which his principal empowered him at once to proceed with making the machine. Robert obtained a French patent, dated January 18, 1799, for his invention for fifteen years. Unfortunately he could not agree with Leger-Didot as to the terms for working the patent and therefore first endeavoured to work the invention on his own account, but partly because his means were not sufficient, and partly in consequence of the illness of his wife, he got into very low circumstances. Finally, he agreed with Leger-Didot, who took over the patent on March 28th, 1800, for frs. 27,400, the wire being an endless copper band guided in the manner of present-day deckle straps, or a leather belt. The water from the wire was collected in a bath under the wire and supplied again to the mixing chest by a scoop wheel. The wire was driven by a coucher, whose top roll was even then placed back towards the breast-roll. After leaving the coucher the paper arrived on a wet felt, went with this through a wet press, and was finally rolled up on a winch.

From all appearances Leger-Didot had but little financial result from his endeavours lasting many years in improving and introducing the paper machine, although a number of machines were made in France according to his designs. He died in the year 1829 in the paper mill built by him, and still existing at Vieux Jean d'Heures, at the age of sixty-two, one year after Robert, who finally supported himself at Dreux as a teacher.

## Paper for the Lithographer\*

By Chas. Harrap

In the widest sense lithography embraces the papers required for: Posters, show-cards, labels, calendars, Christmas cards, birthday cards, post cards, booklets and leaflets in color, book illustrations, toys, books, picture books, concert and ball programmes, menu cards, visiting cards, music, stationery and die stamping, maps, plans, written circulars, law writings, testimonials, photogravures, engravings, mezzotints, cigarette cards, wrappers and paper bags, waterproof and greaseproof packages, tracings, manifold books, transfers, photo-lithography, and other photographic purposes. Even such an enumeration as this only gives the broad idea of its utility, without its special treatment as an article which is indispensable to the processes of the craft, before the production of the finished print.

In the course of business the lithographer is called upon to use every variety of paper, from blotting and soft tissues, to the hard-sized account book papers, cartridges and the finest hand-made manufactures. Every thickness, every surface, every degree of softness pass through the trade at one time or the other. Beyond the actual papers, there are those in which the paper is of a secondary importance to the coating upon its surface; such being the series of bright and colored enamels, the dull enamels, the "Art" papers, and the papers with a composition surface not much unlike cold-water distempers. And as these papers, especially the dull enamelled ones, form the largest single class used, it is of the greatest importance they should be studied with a view to meeting the requirements of the lithographer. Next in general importance, probably in quantity greater, are the writing papers. These vary in surface, thickness, and sizing to a considerable extent, and have given the greatest amount of trouble in lithographic printing, because they are in

daily use, and are subject to the varying tastes of the customers. One thing does not vary, and that is the customer, who always expects the work well printed regardless of the paper.

Although lithography would appear to be one set method of production, as far as the public is concerned, yet within the walls of the printing office there are several varieties in means, and several varieties of paper required to carry out the processes of the work. The name of the process would imply that the printing is all produced by printing from the surface of stone. That has been the case, but is not so at the present time by any means. The craft has taken up the use of both zinc and aluminum as the printing surfaces, and has no longer confined its mechanical means of printing to the flat-bed machine. The extensive use of the metals has opened up a very wide range of production. And it has resulted in the use of fast-running rotary machines. These rotary machines are of two forms; the one is for printing direct from the metal upon the paper, and the other is for printing by an offset method. This latter has carried with it the possibility of printing every kind of paper which can be manufactured.

To be more explicit, there is the limited range of papers which can be printed by the flat-bed machines, and the whole range of papers which can be printed by the offset method. Beyond these are the papers which must be used for the processes of transferring, and the making of the picture transfers, and the papers which are used for interleaving the prints during the stages of printing, and for miscellaneous purposes. This wide use of paper has only been made possible since the introduction of the "offset" method, which was invented in 1906. But, from that time the strides made in printing by the lithographic, or, rather, the planographic method, has caused quite a revolution in the means employed. In fact, the use of all kinds of paper has been

\*Abstracted from a lecture delivered before Battersea Polytechnic, London.

very greatly assisted, and some at least of its difficulties have almost disappeared. All it wants now is the co-operations of the paper-maker to make the business a really pleasant one, instead of a very tiresome one, owing to the vagaries of the paper used. It is to be feared that if the ideal conditions of the paper required were set forth that the paper-makers would say at once that we are expecting too much. That may be so, but if the paper-maker knows what is wanted, he can experiment along the right lines to produce it.

Notwithstanding that the "offset" method of printing has now been before the printers for some five or six years, it will be readily understood that all the firms have not been able to instal this new form of machine, and in point of fact have not the amount of business which would warrant that they should. For those who must continue with the flat-bed machine or direct rotary working from stones or plates, there are points in the paper which must be touched upon. Some of these points may seem small ones, but as the opportunity of placing them before paper makers is with us, it would be a loss of time to omit to do so. Most of the matters arise from the process of manufacture, and may be briefly stated as the results of the sizing, watermarks, surfacing, stretching and the composition of the pulp.

Taking these in the order already given, the first point is:—

#### The Sizing.

It has become the custom to size certain papers with a hard or animal size, which gives to the paper a hard, impervious coating, suitable for writing upon, perhaps, although there are differences of opinion on that point. The surface produced by this sizing is not, however, one with which the printer is at all enamored. It presents a hard, greasy surface which will not take the ink at all kindly. If it is really necessary to have this nature of sizing, efforts should be made to find one which is not so hard. From a casual inspection of the paper and the uses to which it is put, I am not at all impressed with the real necessity of having this kind

of size at all. It is largely an animal matter, subject to decomposition, subject to contain a small amount of grease, and with little or no recommendation. It may be from custom that there is still a call for it. It may be that the original hand-made paper was all animal sized, and it became the general. Such fancies have existed in other matters and may still prevail in this. I know that I sometimes use animal-sized paper and find it very difficult to write upon—in fact, am sorry that I ever used it. It seems that the public requires educating to the fact that these hard, animal-sized papers are no longer necessary in a general way, and can very well be replaced by the softer sized material. The paper-maker should experiment with the sizing until a size is found for hand-made papers which is suitable to the writer as well as the printer. It must be borne in mind that in attempting to print on paper with a non-absorbent sizing, that it is next to impossible to get a series of printings which follow one upon another, to sink sufficiently into the substance to allow of proper drying, and to allow the next color to lift upon the one before. So that if this class of paper be the best, it is not possible to use the best paper for the best class of color printing. All the color work must be done on what may be termed an inferior paper. This may be only a matter of opinion, as printers themselves think that as good papers are made without animal size as those with it. The great difficulty in printing upon these hard-sized papers is in producing a firm impression, and it becomes necessary in many cases to damp the paper sheet by sheet before printing can be commenced. This is of no good to the paper itself, or to the possibility of being able to add a further printing in another color, with much hope of getting it in register with the first printing. The printer has not only to damp the paper, but has to etch the stone into high relief, with all its attendant troubles in the process of printing. It is, in fact, a wasteful method of printing, and it rests with the paper-maker to devise a form of paper and sizing which shall save these items of cost and



trouble. Such a change would make some forms of printing less expensive and would encourage the public to indulge in more printing than they do at present. It may be argued that the difficulty can be overcome by printing by the "offset" method. Yes, that would be true if every firm had an "offset" machine; but, at the present time, there are still ten times as many of the flat-bed and direct rotary machines as there are of the "offset" machines, and this large number of machines should be catered for on the right lines.

There is just one other feature of these animal-sized papers which must be mentioned before leaving the subject, and that is, that as the sizing is of an organic origin it is subject to decomposition. This may not appear to be of much moment when it is generally understood that paper in its various forms of books and documents is taken special care of, and is kept dry and free from harm. If that were always true it might be safe to use the animal-sized papers. But papers must be kept in stock by printers and others, and the conditions of storage are not by any means ideal. It frequently happens that the store has to be in such corners as can be spared; and the reams are likely to be damaged at the corners and along the sides; it is in such cases that the animal-sized paper is exposed to the air and commences the decomposition which terminates in the edges of the paper becoming brown and useless for that printing where the work has to be printed upon paper with the original edges to the sheet.

What I have said about hard animal-sized papers may appear somewhat erratic, because it is well known that the papers which are animal-sized possess a character which has not been approached by any engine-sized paper. It is necessary to have animal-sized papers because they give to paper a durability and strength which enable them to be employed in ledgers, for documents, bank notes, maps, charts and all similar purposes where the paper is in constant use. Documents such as some of these are subject to comparatively rough usage. There are times when erasures are necessary, and for that purpose the animal sizing is suitable. But it is to the use of animal-sized

papers indiscriminately, for matters which are of no lasting importance, to which I refer. Animal-sized papers when smooth are recognized as fine writing surfaces, but neither writing ink nor printing ink dry readily upon it. This is a drawback of no small moment to printers.

#### Watermarks.

On the subject of watermarks there is but little to be said. Most makers like to brand their papers with some sign of its origin. This may appear necessary from the maker's point of view, and is no doubt of some considerable value to the printer as a means of finding the source of supply. Some makers have a large and elaborate watermark, which fills about one-quarter of the paper right in the centre of a foolscap sheet. I have just had a sample of a typewriting paper of this description, where the watermark is not only large, but is deeply impressed in the paper. I do not suppose that the majority of paper-makers ever think what trouble they are giving to the printer when they are breaking up the evenness of the surface with these artistic emblems. In fact, from the progress which has been made in producing watermarks of beautiful design, and introducing pictures or portraits, it would seem that the printer is of no consideration at all. If the paper-maker would only make himself acquainted with the art of printing he would soon see that wherever the watermark appears on the paper the printer is more or less unable to get down to the depressed surface satisfactorily, and has to be content with a broken print on the watermarked surface. If it were possible I would not use any paper which bore a water mark.

In connection with this item, if paper-makers would only study the methods adopted on the Continent, they might find some way of producing a paper without spoiling the printing surface. I refer specially to the artistic book production which is carried to the height of perfection in France. Where the book has to be illustrated with work of the finest delicacy, the paper-maker arranges that the watermark is not only small, but that it must fall in the course of printing, close to the margin of the page, and not interfere in the least with the illustration or the type matter.



### Surface.

In touching upon the surfaces of paper, I must traverse the last item so far as it affects the evenness of the paper. If it were possible, I would have paper without the marks of the web or the laid lines. At present that seems impossible. But if it is necessary to have the web marks upon one side there is no need at all to repeat the trouble by using a dandy roll to impress upon the upper surface another set of markings, as is frequently done to imitate paper of a different mode of manufacture. These little innovations may be very clever, and may indicate that nothing is impossible to the paper-maker, but they are only a source of trouble to the printer. As so much of the paper used in printing has to be printed on both sides, it should be the aim of the paper-maker to produce papers with both sides as smooth as possible. Not only should they be equally smooth, but they should be of the same tone and color. As it is at present the printer and the bookbinder have to work in co-operation to form a book so that the opposing pages shall be either both the right side of the paper, or both the wrong side. This suggestion may seem chimerical, but as the paper-maker can do so many other things with paper it would be well if he turned his genius to solve this problem.

Returning from this digression to the surface of paper, it should be borne in mind that as the lithographic printer has to print from a flat surface, he requires a flat surface to print upon. He does not want a surface broken by web or laid marks, or by water-marks; a surface free from loose particles or projecting fibres. The loading must be well incorporated with the pulp, and not left as a dust upon the surface. Further, if a surface be coated upon the paper it, too, must be firm in composition, not liable to come away in dust or patches, or be of such materials as will affect the pigments used to print upon it. The matter of surfacing papers with a dull enamel has reached a high state of perfection, and, providing that the same care is always bestowed upon its production it is generally suitable to the printer's purposes. The printer finds that the enamelled paper varies, and on one occasion it comes away dusty, and on another

occasion it comes off in little patches. This is in a measure due to using the paper too soon after it has come from the mill. But, under the best conditions when it is run in fast-running machines, either with direct printing from metal plates or by the "off-set" method, the composition will come off and seriously interfere with good printing. Then, again, it must be remembered that in the flat-bed and direct rotary machines the paper comes in contact with the wet stone or plate; and in the course of printing a series of colors, that the strength of varnish varies according to the weight of the pigment, its drying qualities, and the necessity of occasionally obtaining a fine glossy finish. All these points want to be studied by the paper-maker to find a composition which will suit all cases. Having secured a coating material capable of withstanding all these strains there is still the necessity of using such inert materials that they will not react upon the pigments used in the inks. Thus any material which contains any trace of sulphur, either free or in combination, should be avoided. It is not advisable, therefore, to use Baryta white as the main constituent of the composition. And compositions made with compounds of lead carry with them disadvantages, both to the printing of colored inks and to the preservation of the whiteness of the paper. The pigments which contain sulphur tend to discolor the lead, and the action of the sulphur in the air darkens the composition.

The same remarks apply equally to all papers which are coated with thin watery pigments to obtain the surface papers used for fox labels. These papers are a constant source of anxiety to the printer. He has to temper the inks, regulate the damping, and adjust the machine in its mechanical parts, as well as its speed, to accommodate the paper. Perhaps there is no form of printing which gives greater trouble than bronzing. This arises from the fact that the bronze is a metallic dust which is put upon the print after the printing is executed, and is not an ink which can be put on in the ordinary way. This necessitates the use of very strong adhesives, which are in many cases so strong that they pull the surface of the paper off. All this tends to show that paper-makers have yet to solve the question

of making paper more as an article to be printed upon than as a mere sheet for mechanical printing from type, or for use as wrappers.

The surface of paper has certain effects upon the printing surfaces themselves. Thus, when a paper is used which has a rough finish the constant contact of the sheets of paper with the stone or the plate will abraid the surface until the work is worn off to some extent.

The use of the enamelled papers involves certain disabilities, as the composition breaks away in an invisible dust and gets on the stone or plate until the work becomes difficult to work from. It has a serious effect upon the grained plates of zinc and aluminum, in that the fine dust gets into the grain, partially fills it, and causes the ink to catch all over the plate in a tint or scum. This is a point which paper-makers should take into account when experimenting with the proper constitution of the composition of the enamel.

#### Stretching.

To the lithographer there is no more important characteristic in paper than its proclivity to stretch. It is always with him. His business depends upon the use of water as an antagonist to grease. It is the essence of transferring; and transferring is the main process of the trade. The stretching of the paper is responsible for more waste of paper and time than all the other faults of paper put together. When paper is too hard to be printed dry it must be damped, and thereby rendered more or less incapable of register. When paper passes through the printing machine it comes in contact with the damped stone or plate, and takes up just sufficient moisture to make it stretch to such a degree that the fine register required in most work is upset. The amount of the stretching may be only 1-32nd in., but in fine work that amount is too much. The printer has to use all the devices which occur to him to take the stretch out of the paper. He runs the paper through the machine in both directions in the hope that the rolling will remove the stretch. The paper is hung up or laid out on racks to let it get seasoned to the conditions of the printing room. Even with all these precau-

tions the same difficulties arise in a minor degree. It would seem that the ideal conditions of printing in the printing-rooms themselves have not yet been attained. There are many occasions when the work has been partly printed that the conditions of the atmosphere have altered so much that it is impossible to continue the printing. It is then that the paper is laid out to dry, or put in a warm room to expel the moisture; or, on the other hand, it may be necessary to interleave the sheets with sheets of slightly damped paper to bring the paper back to the original size when the work was commenced. In the present state of paper-making it is hardly to be expected that these conditions will be readily remedied. The method of making with all the strength of the paper in the length, and all the weakness in the cross-direction is at the bottom of the whole trouble. The only possible way to minimize the defect is to use materials in the pulp which will stretch least under the usage which is meted out to them in printing. Possibly many paper-makers have already taken the matter into serious consideration, as it appears that the best makers always exercise great care in cutting the sheets up. This point cannot be too strongly urged, as it may tend to relieve some of the strain under which the printer now labors. In the actual printing process the sheets are run through the machine with their greatest length across the machine. If in running in this direction the paper stretches, the printer can partially remedy the defect by packing the cylinder. But if the paper stretches in its length, i.e., across the machine, there is no very satisfactory remedy. It behoves all paper-makers to cut all sheets from the web with the greatest length in the direction of the make, to secure that the strongest way of the paper shall always be fed into the printing machine across the board rather than down the board. Again, as paper-makers know the nature of their materials better than anyone else can do, it is in their province to put upon the market machinery and methods for the proper stretching and damping or drying of paper—methods which can be applied in printing establishments. There are instances when, to be more sure of securing good register, the printer will

print on the back of the paper a coating of flake white to give strength and to make the paper less liable to take up moisture. But all these palliatives are only half measures, and it were better if the original paper were in itself a reliable material.

There is another feature of the stretching of paper which is of as great importance as in the actual printing. This is in the operations of transferring. In most cases of transferring a certain amount of water is used, and in most cases it is expected that the work will be transferred without much deviation in size from the original. In the preparation of the transfer paper the composition is put on in a wet condition, and the prepared paper is allowed to dry; subsequently the work is printed on the paper after it has been slightly damped; finally, it is laid upon a stone or plate which has a surface moisture. The transfer is then run through the press under a scraper pressure, which tends to pull it out to its full length. With such handling as this the paper must be of the best to withstand the various strains put upon its fibres. When this work is for prints in which the register

must be exact, the printer has to take the utmost care in selecting the paper, and in seeing that all the pieces of it are cut in the same direction of the make. Further, the printer must set the transfers on the stone or plate in the same direction so that the strain of rolling under pressure will be exercised in the same direction of the fibres. It is matters of this kind which make paper such a doubtful quantity in the art of lithography. As already suggested, the paper-maker should choose the materials for paper which will stretch least, but there is an important provision in this choice in the nature of the materials. It has been found that of the materials used, esparto grass supplies one of the best, and that next to that, mechanical wood. Both these materials in paper give a paper with the least stretch under the best conditions. Whilst esparto is good, the same cannot be said of the wood pulp as a printing surface. Experiments have also shown that sulphite wood gives a paper of very limited stretch, but the presence of sulphur makes it quite an impossible paper for the best color work.

*Continued Next Issue.*

## **Sulphite Liquor Waste**

In recent issues *The Pulp and Paper Magazine* has devoted some attention to the question of the treatment and utilization of waste from sulphite mills. The whole problem is a difficult one, and is being studied in all the pulp manufacturing countries of the world with particular care at the present time. Several years ago the Royal Testing Institute at Berlin, working in conjunction with the Association of German Paper Manufacturers, visited a large number of sulphite paper plants and made a study of conditions under which sulphite liquor is produced. Since then the institute has been constantly at work on this important problem, and has investigated the matter from many points of view.

In 1874 A. Mitscherlich took out an English patent for the production of cellulose and paper fibre by the treatment of wood with calcium bisulphite; later a German patent was also granted. This pro-

cess, of course, entails liquid wastes, particularly sulphite liquor, and it was early recognized that the discharge of such liquors into public watercourses would be decidedly objectionable unless the flow of the stream afforded sufficient dilution.

Mitscherlich developed his process not on a laboratory scale, but at a large practical plant constructed for this purpose in Munden, and the works at once attracted marked attention. The inventor carefully worked out all details of construction, and mentioned particularly the importance of sufficient water, not only to provide for the large volume necessary in the operation of the plant, but also to render inoffensive the wastes incidental to the manufacture of the sulphite pulp.

The inventor considered that the sewage would demand a dilution of 3,000 times to render it inoffensive. Since many plants have been constructed where large dilution has not been available, it is evi-

dent that features other than the question of dilution in running water have controlled choice of site. As is well understood, streams have been grossly polluted and the industry itself has been at a disadvantage because of the demand that the public interest should be protected in the matter of stream pollution from the waste liquor it produces.

There are three different types of wastes produced at sulphite paper plants: 1, Digester liquor and wash water; 2, screen and filter press water from the pulp presses; 3, condenser water and other water discharged in the operation of machinery.

All the above are objectionable wastes, with the exception of the condenser water, which can, of course, be discharged into any stream without causing a nuisance. The most objectionable liquor is doubtless the strong liquor from the digesters and the wash water, both of which wastes contain large quantities of wood products dissolved by the sulphite liquor. The quantity of this water is enormous.

Under German conditions for each pound of paper pulp there will be produced 1.2 gallons of sulphite liquor. In 1908, with an average daily production of 1,650 tons of pulp, the daily volume of liquor averages about 3,960,000 gallons. Average analyses of this liquor showed 376 to 502 tons total solid matter per million gallons, of which from 314 to 376 tons per million was organic matter. Thus there was produced in round figures 1,760 tons of solid matter, of which 1,230 tons was organic matter, which was discharged daily into the German streams.

On an average the liquor has a light or dark brown color, a woody, aromatic smell and generally a decided odor of sulphurous acid. Its reaction is strongly acid. The sulphurous acid is partly in the free and partly in the bound form.

By far the greatest volume of liquor from a sulphite plant is the rinse water from the screens and washing machines. The volume of these wastes is from thirty to fifty times that of the sulphite liquors. This liquor shows characteristics similar to the strong liquor, but it is by no means so objectionable.

At most plants some treatment is given the wastes before their discharge into the stream. This treatment may be merely the removal of fibre, neutralization, cooling, or a partial recovery of sulphur.

Various types of sedimentation basins with subsidiary treatment on slag or sand filters are used to remove the escaping paper pulp. Some types of agitation is necessary during the filtration process. At times the quantity of paper fibre recovered in this manner more than suffices to pay the cost of its recovery.

The treatment of the digester liquor varies. Generally the sulphurous acid is recovered and again the liquor alone or in conjunction with other wastes is treated with milk of lime, cascaded over towers or caused slowly to flow through a neutralizing channel filled with pieces of broken limestone. Generally there follows a subsidiary treatment in sedimentation tanks or ponds, and frequently before the liquors are discharged they are treated with marble dust. In some rare cases the liquors are evaporated and the solid matter is burnt. Generally the waste is but partially neutralized, since most streams contain sufficient alkalinity to neutralize considerable acidity introduced in the form of waste liquors. However, the water of the stream below the sulphite plant should never show an acid reaction.

The introduction of the sulphite liquors into streams in many cases causes the development of algae, and in the smaller rivers the stream beds are sometimes completely choked. Quite surprisingly, algae growth is greater in winter than in summer. The decomposing algae give rise to very objectionable conditions, and are, of course, a menace to health; it is to be mentioned in passing that these liquors contain no pathogenic organisms whatsoever.

Under certain conditions, particularly in streams grossly polluted with organic matter; and in the summer time these sulphite wastes develop tremendous quantities of sulphuretted hydrogen. This condition, of course, entails a rapid loss of dissolved oxygen and the death of all animal and plant life in the stream. Such cases are fortunately rare.



To prevent the growth of algae it has been proposed to store the liquors and discharge them intermittently into the stream and in comparatively large volumes, relying upon the wave action and the force of the current to carry the waste down stream and allow it to be rapidly disseminated in the river water. Opinions differ as to the advisability of this procedure. Much better results would appear possible if the sewage were more evenly distributed in the cross section of the stream than is usually the case.

One solution of the problem which has been suggested is the oxidization of the wastes after they have been considerably diluted. It is questionable, however, whether such a plan would be feasible because of the size of the works required. Intermittent filtration under strong dilution could, however, be used if the wastes were subjected to preliminary decomposition—for example, mixed with city sewage or other putrefactive material.

A large works in Germany is studying on a large scale the disposal of all of its digester liquors and first washings by cooling and neutralizing, and then discharging them into the city sewers, where the wastes mixed with the domestic sewage are treated on extended underdrained areas of sandy soil. The results of this effort to dispose of sulphite liquors will be awaited with great interest.

In practically all attempts to treat sulphite liquors along bacterial lines, the liquors have first been diluted and then neutralized and mixed with domestic sewage. Further work is required along this line, since the experiments were upon a small scale, and but little information was secured regarding the technical features of the method and the question of cost.

If the discharge of the wastes modified in accordance with one or more of the above plans is not possible, it then becomes necessary to prevent the entrance of the liquors into the stream. A method used with success is that of causing the liquors to enter sink holes and mingle with the ground water. Such a plan is possible, of course, only when geological conditions are favorable. Of course, it may happen that the liquor will appear at the surface

at other points and create objectionable conditions.

Evaporation of the liquors and the combustion of the solid matter has been tried in a few instances. The costs, however, are quite excessively great. For example, at a plant in Upper Silesia the cost of evaporating daily 50,000 gallons of liquor was from \$15,000 to \$16,250 per year, or an average of 82 cents per 1,000 gallons.

---

### PAPER MILL FIRES.

Two fires on the same day in a paper mill in Cumberland, Maine, were put out so promptly and with so slight loss that no claims for damages were made. The first fire was caused by a hot box in a blower which ignited oil dripped from the box. The flames spread to the floor overhead which was slightly charred. The fire was promptly put out by the opening of one Grinnell automatic sprinkler assisted by a hose in the hands of operatives. The second fire, two hours later, was caused by spontaneous combustion in a barrel containing sweepings consisting largely of rubber grindings from the rolls and some oily paper stripped from the iron rolls.

Another fire, in Lawrence, Mass., was caused by a hot box on one of the beater engines. The box and pulley were covered by a wooden hood protector which was slightly charred. An automatic sprinkler opened directly overhead, and, aided by the use of a small hose, soon extinguished the fire. The fire department, which was summoned found the fire out.

Another, found in a pulp and paper mill at Canton, N. C., occurred in the soda adjuster ship bind. Two Grinnell sprinklers extinguished the fire almost immediately with no damage to building or contents.

---

—Der Papier-Fabrikant, Berlin, that enterprising organ of the German paper trade, is issuing its annual special convention number. It comprises no less than 330 pages and is a fine example of what our German contemporaries can do in the way of type-setting and illustrations as well as in interesting contents.



## Pulpwood Consumption of Canada, 1911

*Abstract of Report Prepared for Forestry Branch of the Dominion Department of the Interior.*

*By H. R. MacMillan, B.S.A., M.F.*

The 54 firms reporting used, in 1911, 672,288 cords. There were exported in a raw state 847,939 cords, making a total cut of 1,520,227 cords of pulpwood in the manufacture of pulp, valued at \$9,678,616. This is 21,401 cords less than were cut in 1910, but the quantity manufactured in Canada was larger.

Altogether 73,801 cords of wood (i.e., 12.3 per cent.) more were used in 1911 than in 1910. The average price of the wood also increased, so that the value of the domestic pulpwood industry was greater in 1911 by \$752,870, or 21 per cent. The average price per cord was \$6.07 in 1908; \$5.57 in 1909; \$6.00 in 1910; and \$6.45 in 1911. Only 22,229 tons more of pulp were produced in Canada in 1911 than in 1910.

There was a decrease of 93 pounds in the amount of pulp produced per cord of wood; it is difficult, however, to secure trustworthy data as to the output of pulp, since many firms do not give the air-dry weight.

Quebec is the premier pulpwood province of Canada, because of its extensive spruce and balsam fir forests fit for pulpwood, its abundant and cheap water-power and its splendid supply of labor. The 28 mills in Quebec reported a consumption of 58 per cent. of the total for Canada, or 47,671 cords more than in 1910. The quantity used was 13.9 per cent. more than in 1910, and the value 33.9 per cent. greater. Ontario, although suffering from the flooding of one mill, increased the amount consumed in its fourteen pulp-mills by 3,115 cords, and used nearly one-third of the total production. New Brunswick is recovering from the depression of 1910, and contributed 45,824 cords, or 6.8 per cent. of the total. In 1909 it used 88,450 cords, being 14.2 per cent. of the total, so the recovery is still incomplete. In Nova Scotia, where one large mill was burned early in the year, the consumption has increased by 115 cords as compared with 1910. Low water prevented the mills of New Brunswick from

manufacturing at full capacity during 1911. The Province of British Columbia is still experimenting in pulpwood manufacture, and the negligible amount reported from this province is manufactured for test purposes only.

In Ontario the price of pulpwood was less by 20 cents in 1911 than in 1910. The increase in the price of wood throughout Canada is due almost entirely to Quebec, where the price increased 97 cents per cord. Of all the provinces Nova Scotia shows the lowest average price for pulpwood, namely, \$5.00 per cord.

The increase in the quantity of pulpwood used in 1911 was practically confined to spruce—78,046 cords more of this species being used than in 1910. Poplar increased by 578 cords, regaining third place among pulp woods, while hemlock and balsam fir decreased, the former by 2,140 cords, the latter by 3,075 cords. Most of these changes took place in the Province of Quebec, which used 52,446 cords more of spruce, 3,178 cords less of balsam fir, 2,096 cords less of hemlock, and 641 cords more of poplar. New Brunswick also showed a large increase in the spruce used.

Although the reports furnished from the mills do not indicate it, the proportion of balsam fir used is yearly increasing. Balsam fir and spruce are used in mixture in the manufacture of news print. A few years ago it was thought that if the proportion of fir was increased above twenty-five per cent. an inferior paper would result. Greater skill in papermaking has shown that the proportion of fir may be increased to forty per cent. or over. This is now being done by some mills and the resulting paper has proved satisfactory. In various parts of Eastern Canada, particularly in Quebec, balsam fir forms from twenty to fifty per cent. of the forest. The practice of the companies now operating is to take spruce and balsam as they occur in the forest. On account of the prejudice still existing

against balsam fir, it has not been expedient for the mills to keep track of or report the exact proportion of balsam fir used. Hemlock, which was third in 1910, has retired to fourth place in 1911. Although it has fallen off nearly 60 per cent. since 1910, more than twice a month as much of it was used as in 1909. There is reason to suppose that a larger export of hemlock took place. While more poplar was manufactured in 1911 than in 1910, it is still below the amount for 1909. Jack pine has not been reported as a pulp wood since 1908. Before that time it was used considerably by two large mills, but has proved unsatisfactory. Arrangements are now being made in Ontario and Quebec for a further use of jack pine.

During 1911, no slabs or saw-mill waste were reported as being converted into wood-pulp in Canada, but from the reports made to the Forestry Branch by saw-mill operators it would appear that a very small quantity of mill waste is so utilized by three companies operating saw-mills and pulp-

mills under the same ownership. This is an economy practised to a greater extent in other countries, and by neglecting it Canada is losing greatly. It has been conservatively estimated that if all useful logs left in the bush by lumbermen, large-sized branches, slabs and other mill waste from the lumber industry in Canada, had been converted into pulpwood in 1911, the annual output of pulpwood would have been increased and not a single acre need have been cut over for logs to make wood-pulp only. During 1910, in the United States, six and a half per cent. of the total consumption was from slabs and mill waste. If economy had been practised to the same extent in Canada during the year 1911, as much pulp might have been produced, without cutting one additional pulp log, as is manufactured from over 43,000 cords of wood. This is almost as much pulp as New Brunswick produced in 1911. The sooner such practical economy and utilization of waste commences, the longer will Canada have an adequate supply of pulpwood.

PULPWOOD, 1911, BY PROVINCES, SPECIES AND PROCESSES: Quantity of Wood Used.

TOTAL—ALL PROCESSES.

Provinces.	Total Cords.	Balsam				Poplar Cords.	Un- specified. Cords.
		Spruce. Cords.	Fir Cords.	Hemlock. Cords.			
Canada. . . . .	672,288	548,276	117,400	1,670	4,186	756	
Quebec. . . . .	390,426	292,270	92,756	1,520	3,124	756	
Ontario. . . . .	213,667	193,720	18,957	.....	990	...	
New Brunswick . . . . .	45,824	44,140	1,684	.....	.....	...	
Nova Scotia . . . . .	22,221	18,146	4,003	.....	72	...	
British Columbia . . . . .	150	.....	.....	150	.....	...	

MECHANICAL PROCESS.

Canada. . . . .	406,325	315,474	89,473	400	222	756
Quebec. . . . .	267,707	191,919	74,632	400	.....	756
Ontario. . . . .	111,597	102,293	9,154	.....	150	...
Nova Scotia. . . . .	22,221	18,146	4,003	.....	72	...
New Brunswick . . . . .	4,800	3,116	1,684	.....	.....	...

SULPHITE PROCESS.

Canada. . . . .	214,595	185,187	27,124	150	2,134	.....
Ontario. . . . .	101,230	91,427	9,803	.....	.....	.....
Quebec. . . . .	76,191	56,736	17,321	.....	2,134	.....
New Brunswick . . . . .	37,024	37,024	.....	.....	.....	.....
British Columbia . . . . .	150	.....	.....	150	.....	.....

SODA PROCESS.

Canada. . . . .	51,368	47,615	803	1,120	1,830	.....
Quebec. . . . .	46,528	43,615	803	1,120	990	.....
New Brunswick . . . . .	4,000	4,000	.....	.....	.....	.....
Ontario. . . . .	840	.....	.....	.....	840	.....

In Quebec, three-fourths of the wood used was spruce. Balsam fir made up 23.8 per cent., and the remainder consisted of small quantities of hemlock and poplar. Only Quebec cut all four species used for pulpwood in Canada in 1911. No hemlock was reported from Ontario or Nova Scotia, while New Brunswick used spruce and balsam fir only. In Ontario, spruce made up nine-tenths of the pulpwood used, and balsam fir nearly one-tenth; less than one per cent. was of poplar. In Nova Scotia, more than four-fifths (81.7 per cent.) of the wood used was spruce, 18 per cent. was balsam fir, and the remainder (0.3 per cent.) was poplar. In New Brunswick 96.4 per cent. of the wood was spruce, and the remainder balsam fir.

Three-fifths, or 60.4 per cent., of the pulpwood manufactured in Canada in 1911 was manufactured by the mechanical process. The sulphite process consumed nearly one-third, and the remainder (nearly 8 per cent.) was manufactured by the soda process. Quebec made two-thirds of the total mechanical pulp in Canada, more than twice as much as did Ontario. Of sulphite pulp, Ontario produced the most, with Quebec second. The latter province manufactured nine-tenths of the pulp made in Nova Scotia. While over four-fifths of New Brunswick's output was manufactured by the sulphite process. Of the remainder, about one-half was produced by each of the other processes.

Spruce, as in former years, was the chief wood used in each process. More than half (57.5 per cent.) was made into mechanical pulp; more than one-third (33.8 per cent.) was manufactured by the sulphite process, and 8.7 per cent. by the soda process. In 1910, the proportions were 68.8 per cent. by the mechanical process, 28.7 per cent. by the sulphite process, and 2.5 per cent. by the soda process.

Balsam fir is being used more than formerly in the mechanical process, and less in the sulphite process. It has also been used in the soda process for the first time in 1911. The proportions were, in 1911: mechanical, 76.2 per cent.; sulphite, 23.1 per cent.; and soda, 0.7 per cent.; and in 1910: mechanical, 53 per cent.; sulphite, 47 per cent.

Two-thirds of the hemlock used (67.1 per cent.) was manufactured by the soda process; nearly one-fourth (24 per cent.) by the mechanical process, and the remainder (9.0 per cent.) by the sulphite process. In 1910, the proportions were: soda, 84 per cent.; mechanical, 16 per cent.

Although the physical properties of poplar do not adapt it for grinding by the mechanical process, 5.3 per cent. of the poplar was manufactured by this process in 1911; 51 per cent. was manufactured by the sulphite process, and 43.7 per cent. by the soda process. These proportions did not differ materially from those of 1910.

Spruce furnished 77.6 per cent. of the wood used for mechanical pulp in 1911, and balsam fir 22.5 per cent., with small quantities of hemlock and poplar making up the balance. In 1910, the proportions were: spruce 83.2 per cent., balsam fir 16.6 per cent.

The average cord of wood reduced by the mechanical process in 1911 produced 1,783 pounds of pulp. This is 125 pounds less per cord than were produced in 1910, and 133 pounds more than in 1909; but these comparisons depend greatly on the relative condition of air-dryness of pulp. Slightly over half this amount of pulp is produced per cord of wood by either the sulphite or the soda process, but the quality of texture is much better. The paper used in the average newspaper of to-day is composed of about 25 per cent. of sulphite fibre and 75 per cent. of the ground-wood fibre made by the mechanical process.

Of the wood used in the sulphite process, 86.3 per cent. was spruce, nearly half of which was from Ontario. Balsam fir furnished 12.6 per cent., about two-thirds of which was from Quebec, and the same province used 2,134 cords of poplar to make sulphite pulp.

The average production of pulp for every cord of wood used in the sulphite process during 1911 was 1,029 pounds. This is 32 pounds more than last year, but these figures are not very significant, since, as with the mechanical pulp, they depend largely on the residue of moisture.

In British Columbia, experiments are being carried on with the sulphite process, and, in 1911, 150 cords of hemlock were used in the manufacture of paper.

Canada has the distinction of having the oldest soda mill in America, although the process is, at present, not in general use, and is found only in a few mills. About three times as much, however, was produced in 1911 as in 1910, and the growth of this branch of the industry may be expected to continue in the immediate future. The increase of kraft paper, for which a few mills are now being equipped, will result in a large manufacture of soda pulp.

The soda process was the principal method used in the reduction of hemlock. Small quantities of poplar and balsam fir and a large quantity of spruce were also used in 1911. Of the total, spruce formed 92.7 per cent.; poplar 3.5 per cent.; hemlock 2.2 per cent. and balsam fir 1.6 per cent., the last-named species being considered unsuitable for this process.

Quebec manufactured 90.6 per cent. of the pulp made by the soda process: 8.3 per cent. of the soda pulp was from New Brunswick, and 840 cords of poplar con-

sumed by this method in Ontario made up 1.6 per cent. of the total.

The average amount of soda pulp produced per cord was 939 pounds, or 90 pounds less than by the sulphite process.

In table 4 the information given in the first three tables is collected and presented in tabular form, giving more details. The figures for the pulp produced are estimates rather than compiled statements, for the reports varied so greatly in the ratio of wood used and pulp produced as to make it certain that the pulp was weighed at different stages of dryness by different firms.

Canada's foreign trade in wood-pulp has not kept pace with the growth of the industry. Unfortunately, more than half the pulpwood cut is still exported in the unmanufactured form. This is a direct loss to the country, for the increased value due to manufacture is given away. The data in the following table refer to the calendar years, and have been furnished by the Department of Trade and Commerce:

Export of Wood-pulp, 1910 and 1911: Quantity, Total Value, Average Value per Ton, Per Cent Distribution and Chief Countries Importing.

Kind of Pulp and Countries to which Exported.	1910.		Average Value Per Ton		1911.		Average Value Per Ton	
	Quantity.	Value.	per ton	Cent	Quantity	Value.	per ton.	Cent
	Tons	\$	\$ cts.		Tons	\$	\$ cts.	
Wood-pulp exported, aggregate . . . . .	328,977	5,694,896	17.31	100.0	259,514	4,902,862	18.89	100.0
Total Mechanical Pulp . . . . .	288,807	4,234,705	14.66	87.8	221,167	3,436,670	15.54	85.2
Total Chemical Pulp	40,170	1,460,191	36.35	12.2	38,347	1,466,192	38.23	14.8
Mechanical Pulp—								
To United States..	214,469	3,450,831	16.09	74.3	219,240	3,408,885	15.55	99.1
To United Kingdom	62,103	657,183	10.58	21.5	1,847	26,185	14.18	0.9
To other countries*	12,235	126,691	10.35	4.2	80	1,600	20.00	.....
Chemical Pulp—								
To United States..	39,947	1,451,068	36.32	99.5	38,279	1,463,905	38.24	99.8
To United Kingdom	178	7,398	41.56	0.4	68	2,287	33.63	0.2
To other countries*	45	1,725	38.33	0.1	.....	.....	.....	.....

\*France, Belgium, Mexico, Australia, Cuba and Japan, in 1910; in 1911 export was confined to Newfoundland.

Mr. J. E. A. Dubuc, managing director of the Chicoutimi Pulp Co., was in Toronto a few days ago. His company will have a capacity by September 1st of 250

tons of ground wood pulp at Chicoutimi and 60 tons at Ouatehouan Falls. This places the Chicoutimi Pulp Co. as the largest ground wood pulp mill in Canada.



## Trade and Manufacturers' Notes

### MOTOR DRIVE FOR JORDAN ENGINES

James F. Lanigan, jr., of Lawrence, Massachusetts, has invented certain new and useful improvements in motor drives for Jordan engines, relative to a novel connection between a motor and the plug shaft of a Jordan engine which permits the necessary adjustment of the plug shaft as the plug wears without interfering at all with the operation of the motor.

There are many advantages in driving a Jordan engine direct from a motor. The principal difficulty in practically accomplishing this is that the shaft of the Jordan engine requires to be adjusted longitudinally to take up the wear which occurs in the plug, and such adjustment of the plug requires a connection between the

The coupling now is in the nature of a telescopic connection, but it is also somewhat flexible so that it will operate freely even though the motor shaft and the plug shaft are not exactly in alignment.

Fig. 1 is a view of a Jordan engine and motor showing a coupling embodying the invention for coupling the motor to the engine shaft.

Fig. 2 is an enlarged section on substantially the line x-x, Fig. 1.

Fig. 3 is an enlarged section on the line y-y, Fig. 2.

In the drawings, 3 designates generally a Jordan engine, 4 the plug shaft thereof and 5 the mechanism for adjusting the plug shaft longitudinally to take up wear in the plug. Since a Jordan engine is a well-known type of refining engine commonly used in the manufacture of paper, it is not deemed necessary to further illustrate it. 6 designates an electric motor of any suitable or usual construction adapted for rotating the plug shaft 4 of the Jordan engine. This motor is provided with an armature shaft 8 which is journaled in suitable bearings 9 supported on a base 7, and the base 7 is in turn rigidly secured to the base 10 on which the Jordan engine is fixedly secured. For coupling the motor shaft 8 to the plug shaft 4, there is provided a coupling having the following construction.

Fast on the motor shaft is a head 11 which has extending therefrom a plurality of pins or arms 12, each preferably provided at its end with a head 13. The plug shaft 4 has mounted thereon another head or plate 14 which has extending therefrom a plurality of pins 15, each also provided with a head 16. The pins or arms 12 are arranged in a circle and the pins or arms 15 are also arranged in a circle, but the circle of the pins 12 is of a different diameter from that of the pins 15, the pins 15 being shown as in a circle of larger diameter than the pins 12. An endless belt 17 is passed around outside of the pins 15 which occupy the circle of larger diameter, and inside of the pins 12 which occupy the circle of smaller diameter, as clearly seen in Fig. 2, so that when the

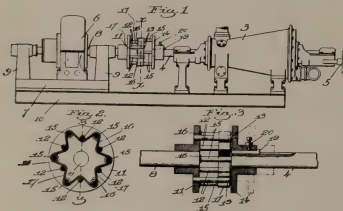

plug shaft and the motor which will permit the plug to be adjusted without affecting or disturbing the operation of the motor.

One means of overcoming this difficulty heretofore proposed has been to mount the motor on a movable base and provide connections between the plug-adjusting means and the motor base whereby the motor is shifted longitudinally with the plug shaft when the latter is adjusted. With an arrangement of this sort, however, it is somewhat difficult to keep the motor shaft properly aligned with the plug shaft. Another way of overcoming the difficulty which has been proposed is to couple the motor shaft with the plug shaft by means of a telescopic coupling which permits longitudinal adjustment of the plug shaft without affecting the motor shaft.



motor shaft is operating the action of the pins 12 on the belt will rotate the plug shaft 4.

The pins 12 and 15 have a length considerably greater than the width of the belt 17, and when the engine is first set up the parts will be in the position shown with the ends of the pins overlapping a distance equal to the width of the belt so that the belt 17 will be held between the heads 13 and 16 of the pins. As the engine plug wears the plug shaft 4 may be adjusted longitudinally to take up wear, and during this movement the head 14 will be moved toward the head 11 and the pins 15 will be slid through the belt 17. This arrangement permits the plug shaft 4 to be adjusted longitudinally for taking up wear a distance equal to the distance between the ends of the pins 15 and the head 11, and when the plug shaft has been moved through this distance the parts will be as shown in Fig. 3, that is, the pins 15 will abut against the head 11 and the pins 12 against the head 14.

To permit further adjustment of the plug shaft the head 14 is adjustable on the plug shaft 4, as seen in Fig. 3, so that when the plug has been adjusted as far as the pins 12 and 15 will permit, said head 14 may be set back on the shaft 4 into the dotted line position Fig. 3 thereby to bring the pins 12 and 15 into the same relative position in which they are in Fig. 1. When the position of the head 14 on the plug shaft 4 has been thus shifted, as shown in dotted lines Fig. 3, said plug shaft 4 may be still further advanced to take up wear until the pins 12 and 15 alone come into contact with the heads 14 and 11 respectively. By thus making provision for shifting the position of the head 14 on the plug shaft 4, it is possible to provide for adjusting the plug shaft 4 longitudinally a foot or more without having the pins 12 and 15 of so great a length that they will be liable to bend when the heads are separated from each other, as shown in Fig. 1.

The head 14 may be secured on the shaft 4 to permit longitudinal adjustment thereof in any suitable way. As herein shown, said head is keyed to the shaft by means

of a key 19, and a set screw 20 is employed for locking the key in place.

The construction above described provides the desired slip or telescopic connection between the plug shaft 4 and the motor shaft 8 and at the same time the connection is sufficiently flexible so that there will be no binding of the parts even though the plug shaft and motor shaft are not accurately in alignment.

Heretofore it has been proposed to provide a flexible shaft coupling comprising two heads on the two shaft ends to be couples, each having pins extending therefrom, the pins on one head being on a larger circle than those on the other head and a flexible connection around about the pins. In this improvement provision is made for adjusting the two shafts to be coupled together longitudinally relative to each other, and the claims herein are directed to this feature.

It will be obvious that this improved coupling may be used for coupling the Jordan engine shaft to any driving member even though it was not a motor shaft, and also that it might be used in other relations where two shafts are to be coupled together, one of which requires to be adjusted at intervals longitudinally relative to each other. Further information may be obtained on application to Emerson Mfg. Co., Lawrence, Mass.

#### JEFFREY MFG. CO.

The Jeffrey Mfg. Co., manufacturers of elevating, conveying and power transmission machinery, etc., Columbus, Ohio, favor us with a copy of their General Catalogue No. 82. We need not give detailed particulars of the machinery this firm makes under each of these headings, for it is well known all over the continent. Moreover, the catalogue is so comprehensive—it contains no fewer than 576 pages—and the illustrations so clear, that it is not necessary to more than refer to this subject. In a future issue we hope to describe one or more of their more important installations. The Jeffrey Mfg. Co. are placing this handsome catalogue in the hands of customers and intending purchasers and its usefulness to those inter-

ested in the products it turns out cannot be exaggerated.

#### QUILLER CENTRIFUGAL SCREEN.

The Waterous Engine Works Company, Brantford, who have obtained the Canadian manufacturing rights, and who are now building the Quiller Centrifugal Screen, report exceptional success with this machine.

Since commencing manufacture in May, 1911, over seventy-five Quiller Screens have been sold by this company, and placed in Canadian mills. Without exception their endorsement has been of the highest, and their record for operating economy and general efficiency established in European and American mills, has been easily maintained by the Canadian users.

In the J. R. Booth mills, where the first Quiller Screen installed was given a thorough test, the machine showed a screening capacity of 20 tons per 24 hours, on ground wood pulp, through .065 perforations, with a power consumption less than 25 h.p. A second screen has been installed in the Booth mill since this test was made.

Among other recent Canadian installations may be mentioned: Price Bros., Jonquiere, Que., 16 screens; Lake Superior Paper Company, Sault Ste. Marie, 14 screens; Belgo Canadian Pulp & Paper Co., Shawinigan Falls, Que., 2 screens; Chicoutimi Pulp Co., Chicoutimi, Que., 8 screens; Wayagamack Pulp & Paper Company, Three Rivers, Que., 5 screens.

In the recently completed plant of Price Bros. Co., Ltd., Jonquiere, Que., the eight beating engines are all operated from individual 50 h.p. electric motors by the Renold Patent Liner Silent Chain gear as manufactured by Hans Renold, Ltd., Manchester, England, for whom Jones & Glassco, Montreal, are the sole Canadian agents.

A large and dangerous fire devastated Chicoutimi last month, but, fortunately, the large pulp mills there escaped injury.

The Riordon Paper Co.'s issue of \$1,500,000 worth of new stock was readily taken up by British and Canadian investors.

#### H. R. MACMILLAN.

Readers of The Pulp and Paper Magazine are well acquainted with the able articles and the valuable statistical bulletins on the pulp and lumber productions of the country which have appeared in its columns from the pen of Mr. H. R. MacMillan of the Forest Branch at Ottawa. They will be glad to hear, therefore, of his appointment as Chief Forester for British Columbia, the Government of which province is forming a strong organization to take over the work formerly handled by the Crown timber agents; also an important branch of forest work here-

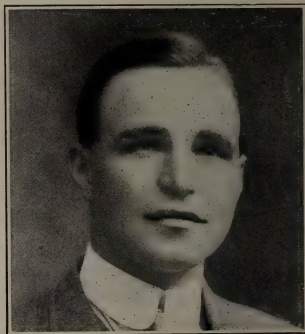

H. R. MACMILLAN  
Chief Forester for British Columbia

before neglected, in the shape of fire protection, study of timber available, regulation of cutting and sale of timber, the creation of forest reserves, reforestation, etc. The appointment was made, we believe, largely at the suggestion of Prof. H. S. Graves, Chief of the United States Forest Service, with whom Mr. MacMillan had come in close contact. The Province of British Columbia is certainly to be congratulated on its choice, for Mr. MacMillan is looked upon as the foremost forestry organizer in the Dominion. He graduated at the Ontario Agricultural College and took a post-graduate forestry course at Yale, utilizing all his vacations in field work for logging companies in Maine and Alabama, for the Dominion Government in Manitoba, Saskatchewan, Alberta and

British Columbia, and for private companies in British Columbia. He also made two trips to study forest administration in the Western United States. During the past year he has been mainly employed in organizing the administrative force on the Dominion forest reserves. He has always displayed the energy and the ability to inaugurate new ideas, which come from a

mind wrapt up in its work, and he originated the study of statistics regarding Canadian forest products, which have proven so useful to the lumber and allied industries. He also started the agitation for a Canadian forest products library. Mr. MacMillan is a member of the Executive Committee of the Society of Canadian Forest Engineers.

## Recent Canadian Patents Affecting the Pulp and Paper Industry

No. 137,111. Machine for Making Hollow Paper Articles. Patented by Henry Baldwin Edwards, New York City, assignee of Oswald Schmidt, Berlin, Germany.

The chief features in this machine, be-

No. 137,403. Machine for Making Pulp Board. Patented by the Keyes Products Co., New York City, assignee of Herbert A. Moody, Boston, Mass. It combines a perforated moulding roll, means to flow pulp

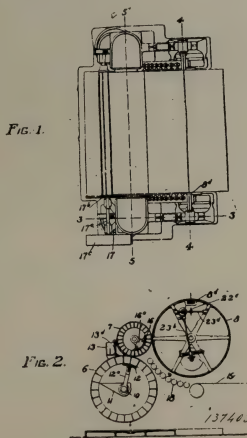
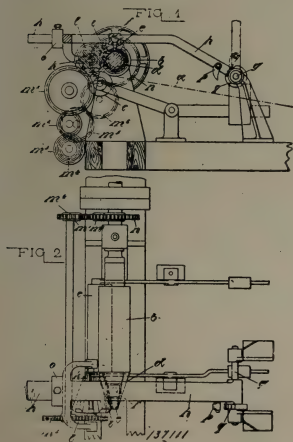

sides the framework, are a winding cylinder mounted in the same and provided with a conical end, a swinging lever carrying a segment adapted so as to bear upon the conical end. There are flexible connections between the lever and the segment and a toother beveled wheel for folding up in connection with the conical end, so as to render it inoperative, as shown in the illustration.

thereon at the upper part so as to form a sheet, means to produce suction through the perforations in said roll, a couch roll cooperating with moulding roll to release the sheet therefrom at a certain point on the upper part of its surface, and a valve in the moulding roll arranged to prevent suction through the perforations in the roll, the perforations in the roll being otherwise open for the suction of air throughout the

whole circumference of the roll. There are also pressure devices to force the rolls together and then to permit the rolls to separate as the sheet increases in thickness; also a cutter with electric motive power to sever the sheet on the roll.

No. 137,462. Fibre Board. Patented by George Kelly, Hinsdale, Ill. This is a process for permanently softening vulcanized compressed and hardened fibre board. It consists in impregnating the fibre, in a succession of stages with a solution of evaporable and non-evaporable liquids for a certain period. The fibre is then removed from the solution so as to permit the evaporable liquid to pass off, the solution at each stage being of greater density than before. The solution consists of glycerine and water, the water being afterwards extracted from the fibre.

No. 139,145. A Method of Treating Pulp Liquids. Patented by E. L. Rinman, Harnas, Sweden. It consists in treating the black liquors from pulp mills by separating the ulmic acids contained in the lye, separating the acetic and formic acids from the same, and heating the salts of organic acids of the residue with a strong base.

#### NEW INCORPORATIONS.

Home Securities Corporation, Ltd., Vancouver. Capital \$40,000. To operate pulp and paper mills.

\* \* \*

French Canadian Timber, Ltd., Vancouver. Capital \$1,000,000. To manufacture wood pulp, etc.

\* \* \*

W. L. Keate Timber & Trading Co., Ltd., Vancouver. Capital \$50,000. To deal in pulp and paper and build mills.

\* \* \*

Canadian Pulp Mill Machinery Co., Ltd., Montreal. Capital \$20,000. A. H. Duff, W. A. Merrill and C. T. Jette, Montreal.

\* \* \*

G. B. Mining & Milling Co., Ltd., Vancouver. Capital \$10,000. To do business as lumbermen, prepare pulpwood, etc.

\* \* \*

Fau-Vel, Ltd., Lakemere, B.C. Capital \$25,000. To take over the business of P.

W. Fau-Vel at Burnaby, B.C., and build pulp and paper mills, etc.

\* \* \*

Canadian Publications, Ltd., Montreal. Capital \$50,000. To publish newspapers, magazines, etc. A. K. Crone, H. Bragg, and S. O. Youngheart, Montreal.

\* \* \*

Quebec Labrador Pulp & Lumber Co, Ltd., Montreal. Capital \$300,000. To do a pulpwood and lumber business, build pulp mills. T. David, J. D. H. Globensky, Montreal.

\* \* \*

Dennison Manufacturing Co. (incorporated under Massachusetts laws), authorized to do business in Ontario with a capital of \$40,000. To make and deal in tags, paper boxes, etc. W. E. P. Howell, Toronto.

The Financial News Bureau of Canada, Ltd., Montreal. Capital \$50,000. To collect and distribute current news and information, publish newspapers and magazines, etc. J. F. Cahill and F. J. Buck, Montreal.

\* \* \*

Textile Publishing Co., Ltd., Montreal. Capital \$60,000. To acquire and publish newspapers, books, magazines etc. J. W. Cook and J. A. Magee, advocates, and T. B. Gould, accountant, are the names mentioned in the Gazette.

\* \* \*

Advertising Letters, Limited, Montreal. Capital \$20,000. To carry on a general advertising business, to do business as printers, stationers, bookbinders, booksellers, publishers, etc. G. S. Robertson H. D. McMullen, H. Day, all of Montreal.

\* \* \*

Scantlebury, Limited, Belleville, Ont. Capital, \$30,000. To do business as booksellers, stationers, buyers and sellers of magazines, newspapers and other periodicals, wall paper, etc. C. B. Scantlebury and Albert Robinson, of Belleville.

The Carrotte-Paterson Co. is asking Fairview, N.S., for tax exemption for 15 years to assist in the erection of a paper mill there.

The Bronson Lumber Co., Ottawa, is building a pulp mill with a capacity of 20 tons a day, which will be increased if the demand for the product calls for it.



**AMERICAN FORESTRY ASSOCIATION.**

The directors of the American Forestry Association will hold their midsummer meeting in the White Mountains at the same time as is held the fifth annual forestry conference under the auspices of the Society for the Protection of New Hampshire Forests, in co-operation with the State Forestry Commission and the Association of North Eastern Foresters.

The directors and their guests from the east, south and west will leave New York in special cars on the New York Central R.R. on the evening of July 16th, arriving at Concord, N.H., on Wednesday morning. There the party will be received by Governor Robert P. Bass, who is president of the association and chairman of the board of directors, and Col. W. R. Brown, a member of the board. The party will then proceed in automobiles seventy-five miles to Deer Park Hotel at North Woodstock, stopping on the way to see the State Nursery at Boscowan and to lunch at Blymouth. At Deer Park Hotel the party will join members of the Society for the Protection of New Hampshire Forests in a short visit to the most beautiful Lost River Reserve nearby, lately purchased by the Society, and will then return to the hotel for dinner and the night.

On Thursday morning, July 18, the party will proceed by automobile through the profile notch to the Mt. Washington Hotel, Bretton Woods, arriving there for lunch and remaining there all of Thursday and Friday. During that time short excursions will be taken to the new State Reservation of Crawford Notch and to some of the tracts purchased this month by the National Forest Reservation Commission under the Weeks Law and for which almost half a million dollars will be spent.

It is expected that there will be assembled at Bretton Woods, besides the directors and guests of the American Forestry Association and the other organizations which are to meet there, several of the Governors of New England States, members of the National Forest Reservation Commission, a number of officials of the United States Forest Service, several Senators and Congressmen and

members of the State Legislatures, as well as forestry officials from all the States within easy reach of New Hampshire.

**UNTEARABLE PAPER.**

A French patent has been issued on a process for preparing an extremely resistant and practically impermeable paper by treating paper made in the ordinary way from extremely long and strong fibres with a vegetable gum which forms a solution or emulsion with water, without the assistance of chemicals. Suitable gum is obtained from plants of the family of Colocasia and is a commercial article, particularly in Japan. The gum may be incorporated with the pulp during manufacture or may be applied to the surface of the finished paper, or both methods may be used. A hygroscopic substance is also used. For instance a paper of substance of 50 gm. per sq. m. may be heated with 20 gm. of the gum and 0.5 gm. of glycerine per sq. m. The fixation of the gum may be improved by treating the impregnated paper with a dilute solution of an alkali at a high temperature. An example of the process for treating paper so as to produce the result specified in the foregoing patent consists, according to an abstract published in the Journal of the Society of Chemical Industry, in preparing a mixture by adding a solution of 10 gm. of gum arabic in 100 cc. of water to a solution of 200 gm. of colocasia gum in 4 litres of water, containing 10 gm. of glycerine and a few gm. of a hygroscopic salt, e.g., 2 gm. of calcium chloride. A sheet of extremely strong paper is steeped in this mixture, dried at the ordinary temperature, again steeped and dried at 50 to 50 degs. C. The prepared paper is placed in a 3 per cent. solution of "soda" at 10 degs. C., then dried at the same temperature as before and moistened with a solution of equal weights of water and glycerine, so that its weight is increased by about 25 per cent.

—Steinman & Heinrich, paper importers, Toronto, favor us with a sample book of cover papers. They are in all tints and very choice.



## Pulp and Paper News

---

The Montreal Paper Co. has ordered a news print machine for its mill at Pont Rouge, Que.

\* \* \*

The first sod of the Ontario Paper Company's new mill at Thorold was turned by James Battle on the 24th ult.

\* \* \*

Jas. B. Barker, who for nearly 40 years was connected with the Staunton Wall Paper Co., Toronto, died a few days ago.

\* \* \*

Edward Finlay, formerly superintendent of the Georgetown Paper Mills, also of the Kinleith Paper Mills, St. Catharines, died suddenly.

\* \* \*

A project is on foot in Tisdale, Sask., to organize a pulp and paper mill industry there. The region is thickly wooded with spruce and poplar. J. Shannon is interested.

\* \* \*

The St. Maurice Industrial Co., which is affiliated with the Berlin Mills Co., New Hampshire, has purchased the large lumber and timber area interests of D. H. Pennington in Megantic County, Quebec.

\* \* \*

The Bayless Pulp and Paper Co. are making plans for building a paper mill at Beaupre, Que., with a capacity of 100 tons daily. A contract has been made with the Stadacona Hydraulic Co., Quebec, for power.

\* \* \*

The Union Bag & Paper Co.'s mills at Cape Madeleine, near Three Rivers, Que., is now running up to its capacity of 100 tons of pulp per day, a large part of which is utilized in its own mill and the remainder shipped.

\* \* \*

The new reciprocal agreement between Canada and the West Indies, details of which have now been published, gives a preference thereof equal to one-fifth less duty than that charged on paper coming from foreign countries.

The E. B. Eddy Co.'s fine new warehouse in Toronto is now practically completed, adding still another fine building to the 28 or 30 owned by this enterprising company between Halifax and Victoria. Jas. Logie, the branch manager in Toronto, expects to distribute at least \$700,000 worth of the company's products this year.

\* \* \*

Recently some reductions in duties were made by order-in-council. They were not of a very important character, and only affected materials made use of by Canadian manufacturers. The only item of change affecting the paper trade was paper matting, which will now be 25 per cent. ad valorem under the general tariff, 22½ per cent. under the intermediate, and 17½ per cent. under the British preferential.

\* \* \*

The National Paper Co. are getting their new coated paper mill at Valleyfield, Que., into shape. This mill, which is operated by steam power and is making the better grades of litho, manila, and book papers coated, has one single and one double surface machine, with a capacity of about five tons per day. The president of the company is Mr. J. R. Walker, of J. R. Walker & Co., Montreal, managing director J. B. Morrow, and secretary-treasurer E. C. Cole.

\* \* \*

The Barber Paper and Coating Co., which recently took over the business of William Barber & Bros. and Canada Coating Mills, Georgetown, has elected G. R. Copping President, S. P. Duncan Treasurer and I. H. Weldon Secretary. John R. Barber, the veteran paper manufacturer, practically retires, though he remains the President of the Toronto Paper Manufacturing Company, and has other financial interests. The mills in Georgetown may be extended.

\* \* \*

The Capital Wire Cloth Co. are making good progress on the building of their factory in Ottawa for making copper

screens and other paper mill supplies. It is hoped to have it in operation by September 1st. J. R. Buchanan and J. Z. Parrazzo, both of whom were connected with the Appleton Wire Co., Appleton, Wis., are president and secretary, respectively.

\* \* \*

At a joint meeting last month of shareholders of Spanish River Paper Mills, Ltd, it was decided that the Ontario Company should be absorbed by the Spanish River Company on the basis of two shares of the latter for three of the former. The capital of the new organization will be increased to \$3,000,000 preferred and \$4,000,000 common. Of the latter \$1,000,000 will be used for the absorption of the Ontario Pulp and Paper Company.

At the ninth annual meeting of Albert E. Reed & Co., Ltd., in London, very satisfactory financial statements were presented. After writing off depreciation, payment of directors' fees, paying interest on debentures and loans, etc., there was a net balance of £93,162, available for distribution as dividends, etc. The pulp mills in Newfoundland were described as having been in continuous operation since last report, turning out pulp of a satisfactory quality. Production has been steadily increasing and is being augmented by installation of additional machinery.

\* \* \*

The Ontario Government has made an agreement with Willis K. Jackson and others, of Buffalo, for the sale of Kendry and Haggart Townships in Northern Ontario, with a view to settling the land. The area involved is 98,364 acres, at \$1 per acre. Part of the profit of the developers of this land is to come from the sale of pulpwood, of which there are large quantities in this region. J. P. Whitson, who is looking after the work of road construction in Northern Ontario, is responsible for the statement that not only is the land richer than is usually supposed, but the resources in lumber and pulpwood far greater.

\* \* \*

The East Canada Power and Pulp Co.'s pulp mill on Malbaie River, Murray Bay,

Quebec, is now completed. The new plant is said to be one of the most modern pulp and paper mills on the continent. The first day's results showed 42 tons of pulp, while to-day the plant is turning out between 105 and 110 tons of pulp, which is at least ten tons a day in excess of the original estimate of the capacity of the mill. It is estimated that when the entire mill is in running order the output will be 130 tons of pulp per day. The pulp is decalred to be a very fine product. The output has been sold for a year in advance. The statement is made that the East Canada Pulp Company has just refused a very large United States contract for immediate delivery. From now on the mills will be run to their fullest capacity.

#### JAPANESE PAPER PRODUCTION.

No accurate statistics are as yet available concerning the production of paper in Japan, but it is believed by some that it must be considerably larger than that of European and American countries. The inventive faculty of the Japanese in the matter of utilizing paper for different purposes is quite striking wherever one looks. Paper is used in the clothing industry, in building houses, etc. The Island Empire boasts of yearly book editions of over 30,000 in number, and the publication of periodicals and dailies is constantly on the increase. The supply of raw material, on the other hand, is steadily decreasing, and in industrial circles practically impossible plans are now being made covering the importation of wood pulp. The Government meanwhile is doing everything in its power to foster the home production of the raw material, and, as a first step in this direction, has offered the Mitsu Bishi Kaisha paper mills about 20,000 hectares of land covered with bamboo trees on the Island of Formosa. This area is supposed to furnish ten million trees annually suitable for the manufacture of pulp, which might relieve the necessity of importation somewhat.

## THE MARKETS

### PULP AND PAPER MARKETS.

Toronto, July 8, 1912.

The heavy demand for news print continues unabated; indeed, it seems to increase, especially that from the United States, where the presidential campaign is still responsible for an extraordinary call for paper. The increased capacity of Canadian mills as paper producers, seems so far not to have had the slightest appreciable effect on the market which is absorbing more and more. It is likely, if the present heavy demand continues, as is more than probable, that an advance in price will be found necessary.

The book and writing mills are well engaged, but find conditions fairly easy to cope with.

Wrapping papers have made another advance since the one recorded in last issue, the discount on manilas having been reduced from 2 to 1 per cent. thirty days. Kraft is also a little firmer.

Rags and paper stock are in fairly good demand and prices are firmer.

Ground wood is a little on the easy side, as a consequence of the large quantities made recently as the result of the heavy rainfalls of spring and early summer. Some mills are piling considerably. Prices as a rule are keeping firm, in spite of the comparative slackness of demand, as the holders believe they must advance when the dry spells come later on. Sulphite is a very strong feature, owing to the scarcity in Scandinavia, and the trade believes that it will go on advancing still more. There has been some demand for Swedish pulp for Kraft.

We quote:—

News print, rolled, \$2.00.

News print, sheets, \$2.25.

Book papers—Carload lots No. 3, 4½c.

Book papers—Broken lots No. 3, 4½ to 4¾ cents.

Carload lots No. 2, 4¾c.

Manila B, 3½c.

Broken lots No. 2, 5½ to 5¾c.

Carload lots No. 1, 5½ to 6¼c.

Broken lots No. 1, 6 to 6¾c.

Wrappings—

Manila B, 3½c.

Fibre, 3¾ to 4c.

No. 2 Manila, 3½c.

No. 1 Manila, 3½ to 4¼c.

Kraft, 4 to 4¾c.

Pulp—

Ground wood (at mill), \$17 to \$18.

Sulphite (bleached), \$50 to \$52.

Sulphite (unbleached), \$43.

Waste Papers, per 100 lbs., f.o.b. Toronto—

No. 1 Hard White Shavings, \$1.65 to \$1.75.

No 2 Hard White Shavings, .... to ....

White Envelope Cuttings, \$1.65 to \$1.75.

(Continued on Page xxviii.)



## TENDERS FOR PULPWOOD LIMIT.

**T**ENDERS will be received by the undersigned up to and including the 15th day of August next, for the right to cut pulpwood on a certain area situated on the Abitibi Lakes and River, tributary to the Grand Trunk Pacific Railway, and the Temiskaming and Northern Ontario Railway, in the District of Temiskaming.

Tenderers shall state the amount they are prepared to pay as a bonus in addition to dues of 40 cents per cord for spruce, and 20 cents per cord for other pulpwoods, or such other rates as may from time to time be fixed by the Lieutenant-Governor in Council, for the right to operate a pulp mill and a paper mill on or near the area referred to.

Such tenderers shall be required to erect a mill or mills on or near the territory and to manufacture the wood into pulp and paper in the Province of Ontario—the paper mill to be erected when directed by the Minister of Lands, Forests and Mines.

Parties making tender will be required to deposit with their tender a marked cheque payable to the Honourable the Treasurer of the Province of Ontario for ten per cent. of the amount of their tender, to be forfeited in the event of their not entering into agreement to carry out conditions, etc.

The highest or any tender not necessarily accepted.

For particulars as to description of territory, capital to be invested, etc., apply to the undersigned.

**W. H. HEARST,**

Minister of Lands, Forests and Mines.

Toronto, Ontario, May 15th, 1912.

EMERSON MANUFACTURING CO.  
LAWRENCE, MASS.

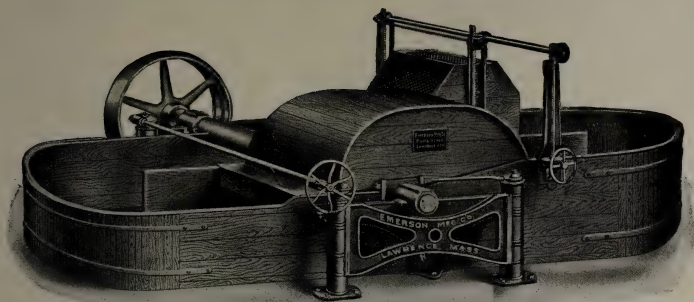

Beating and Washing Engines  
Paper Mill Machinery

THE **UNITED WIRE WORKS** LTD.

Edinburgh, Glasgow & Newcastle on Tyne.

**FOURDRINER WIRES**  
**CYLINDER WIRES**

Wire Cloth all meshes, in Brass, Copper Bronze & Steel.

SOLE AGENTS FOR CANADA

ARTHUR P. TIPPET & CO. 8 Place Royale, MONTREAL.

Wires held in stock at Montreal for prompt delivery.

# Prime Canadian SPRUCE PULP

CHICOUTIMI, P.Q., - - CANADA

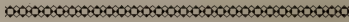

Supplied by the

**CHICOUTIMI  
Pulp Co.**

PRODUCTION:

**About 100,000 tons.**



Sole Agents:

**BECKER & CO.**

Limited

64 CANNON ST., LONDON



TELEGRAMS }  
CABLEGRAMS } MILNE, EDINBURGH

Code ABC 4th & 5th Editions.

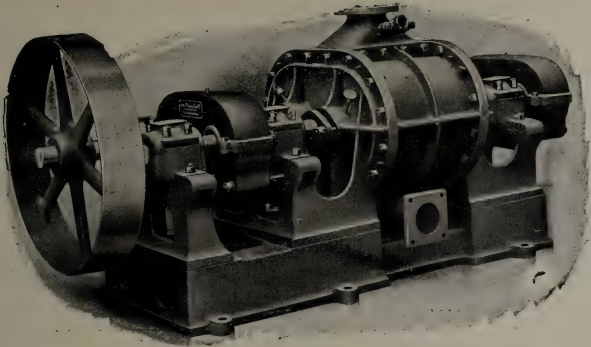

# HIGH DISPLACEMENT VACUUM PUMP

*(Made in Various Sizes)*

Suitable for

SUCTION ROLLS or VACUUM BOXES

MANUFACTURED BY

**JAMES MILNE & SON, LIMITED**

MILTON HOUSE WORKS, EDINBURGH

*DESIGNERS  
AND  
MANUFACTURERS  
OF HIGH CLASS  
PAPER MILL  
MACHINERY*

*FAST RUNNING  
PAPER MILL  
MACHINERY  
A SPECIALTY  
LEAST VIBRATION  
LEAST BREAKAGES*

*Don't Touch Your Mill Equipment Wit' out Trying Milne.*

- No. 1 Soft White Shavings, \$1.25.  
 No. 3 Soft White Shaving, \$1.30.  
 No. 3 Soft White Shavings, \$1.10.  
 White Blanks, \$1.10.  
 Mixed Shavings, 35 to 37½c.  
 Heavy Ledger, \$1.27½ to \$1.40.  
 Ordinary Ledger, \$1.00 to \$1.10.  
 No. 1 Flat Books, 80 to 90c.  
 No. 1 Book Stock, 75c to 80c.  
 No. 2 Book Stock, 39½ to 40c.  
 No. 1 Manila Envelope Cuttings, \$1.20.  
 No. 1 Print Manilas, 65c.  
 Railway Manilas, 25c.  
 Folded News Overissues, 45c.  
 Folded News, 45c.  
 Crushed News, ..  
 No. 1 Mixed Papers 25c. to 35c.  
 Rags (New and Old), per 100 lbs.—  
 1st Old White Cottons, \$2.00.  
 2nd Old White Cottons, ....

Roofing Stock—

- Flock Satinets, 75 to 80c.  
 Ordinary, 55 to 60c.  
 Tailor Sweepings, 55 to 57½c.  
 No. 1 White Shirt Cutings, \$4.75 to \$5.00.  
 No. 2 White Shirt Cutings, ..... to .....  
 Fancy Sheet Cuttings, \$3.65 to \$3.75.  
 New Blue Prints, .. to ...  
 New Blue Overalls, \$3.42½ to \$3.65.  
 New Black Overalls, \$1.60 to \$1.70.  
 New Black Linings, \$1.60 to \$1.75.  
 New Unbleached Cottons ... to ....  
 Bleached and Unbleached Shoe Clips,  
 New Light Flannelettes, \$3.75 to \$4.40.  
 New Light Shirt Cuttings, \$3.90 to \$4.35.  
 Light and Dark Cords, ..... to .....

**BRITISH MARKETS.**

London, June 25, 1912.

Mechanical wood pulp is improving in price, and conditions are in seller's favor, says World's Paper Trade Review. There is a better demand for chemical pulps.

For chemicals, market is steady both for home and export business.

Demand for rags is good, although unsettled in some centres owing to strikes.

**SCANDINAVIAN MARKETS.**

The market for mechanical pulp continues quiet, and, although there cannot be said to be an overproduction, it still appears to be dif-

feult to keep prices at their old level. For bleached mechanical there seems to be quite a number of inquiries out, and the stocks being very small, the prices ought to keep up well.

For Swedish dry mechanical pulp very good prices are named, and Gothenburg sellers are quoting as high figures as kr. 75 —f.o.b.

The chemical market is without change, and prices appear to be on the rise. We are informed that for Swedish strong sulphite as much as £7.10 to £7.116 c.i.f. has been obtained.

The English market has kept very reserved both as regards mechanical and chemical. Nevertheless, the prospects of a large consumption of all kinds of pulp in a near future are becoming more definite for every day that passes.

**MICROSCOPICAL TESTS OF PAPER.**

According to a statement of Prof. Dr. Herzberg, of the Charlottenburg Institute, the old methods have been almost abandoned by which paper for microscopical tests was obtained by scraping off the surface with a knife, or by removing a portion with a needle, the fibres thus obtained being only serviceable to a limited extent. With the process by decoction, not only are the fibres separated, but with them all the other substances contained in the paper, which renders it difficult to define the structure of the fibres. For a long time past the disaggregation of paper has been effected by means of a lye of diluted soda, which gives a clear pulp, suitable for use and not containing any hurtful substances, such as size, filling material or starch. Consequently astonishment is expressed at the proposal of Koenig to abandon the process of decoction and to return to the system of scraping, on the ground that it produces the desired result more rapidly than boiling or loosening the fibre. Professor Herzberg remarks that the fibres are, it is true, more quickly prepared for the object glass, but they are not pure. The decoction of a small sample of paper in a test glass, while being shaken, in order to loosen the fibres, does not take much longer than mechanical defibration.

Telephone: 2726 BROAD.

Cable Address: "LAGERLOF NEWYORK."

# Scandinavian-American Trading Company,

PRODUCE EXCHANGE BUILDING, NEW YORK,

IMPORTERS AND EXPORTERS OF

FOREIGN AND DOMESTIC

# WOOD PULP

OF ALL KINDS

AND

# PAPER MILL SUPPLIES.

HANS LAGERLÖF, PRES.

ALL KINDS OF  
Machines for Paper, Pasteboard,  
Cardboard, Cellulose  
and Pulp Mills

Paper Machines      Calenders  
Winders      Calender Roll Lathes  
Filters (Füllner's Construction)  
Cutters      Cone Refiners  
High Power Grinders      Patent Beaters  
Edge Runners

FIRST-CLASS REFERENCES

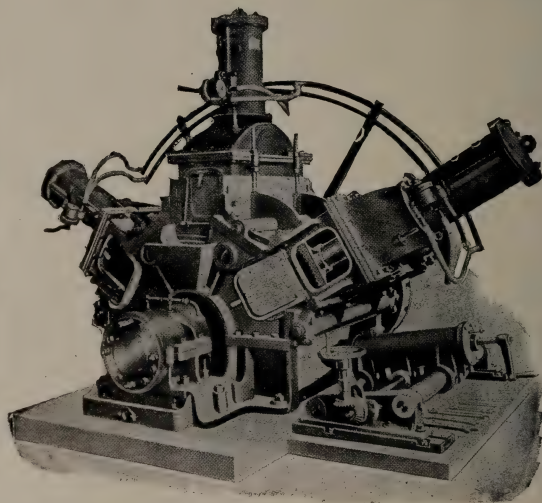

MOST MODERN CONSTRUCTIONS

Founded 1854

**H. FÜLLNER**

WARMBRUNN  
SILESIA  
GERMANY

Prizes won at all exhibitions where machines have been shown.  
Turin 1911 "Grand Prize." Paris 1900 "Grand Prix" und "Kreuz der  
Ehrenlegion." Leipzig 1897 "Gold Medaille." Paris 1907 "Grand Prix."

# CLASSIFIED ADVERTISERS' INDEX

If you fail to find what you want in these columns, write us and the desired information will be gladly supplied

## Architects and Engineers

Ambursen Hydraulic Con. Co.  
T. Linsey Crossley  
J. A. DeCew  
Eaton & Brownell  
Geo. F. Hardy  
Herbert S. Kimball  
International Process Co.  
Arthur D. Little, Inc.  
R. S. Lea & H. S. Ferguson  
Lyford, Clark & Lyford  
H. B. Prather  
Chas. B. Pride  
T. Pringle & Son  
Stebbins Eng. & Mfg. Co.  
R. O. and W. G. Sweezy  
Jos. H. Wallace & Co.

## Barkers.

Carthage Machine Co.  
Green Bay Barker Co.  
Jenckes Mach. Co.  
Waterous Engine Works.

## Beaters.

Dillon Mach. Co.  
Emerson Mfg. Co.  
H. Fullner  
Holyoke Mach. Co.  
E. D. Jones & Sons Co.  
Valley Iron Works  
Waterous Engine Works

## Beater Rolls.

J. A. DeCew  
J. Marx & Co.

## Belting.

Dom. Belting Co.  
F. Reddaway & Co.  
Sadler & Haworth

## Bleaching Powders.

Brunner, Mond & Co.  
Hooker Electro-Chemical Co.  
Winn & Holland

## Boilers.

John McDougall Caledonian Iron Works

## Brass Wire Cloth, Foundriner Wires.

Geo. Christie, Ltd.  
Herman Finckh  
C. H. Johnson & Sons, Ltd.  
Jas. Taylor  
A. P. Tippet & Co.  
United Wire Works  
P. P. Westbye

## Camel Hair Belting.

F. Reddaway & Co.

## Calender Rolls.

Farrel Foundry & Mach. Co.

## Chemicals, Colors, Etc.

Brunner, Mond & Co.  
Gewerkschaft Sachtleben  
A. Klipstein & Co.  
Hooker Electrochemical Co.  
Paper Makers' Chemical Co.  
A. P. Tippet & Co.  
United Alkali Co.  
Wilson-Paterson Co.  
Winn & Holland

## China Clay.

China Clay Co.  
A. Klipstein & Co.  
C. A. Meincke & Co.  
Paper Makers' Chem. Co.  
Wilson-Paterson Co.

## Chippers.

Carthage Machine Co.

## Conveying Machinery.

H. W. Caldwell & Son Co.  
M. Garland Co.  
Jeffrey Mfg. Co.

## Digester Lining.

Panzl Digester Lining Co.  
Preston's Digester Lining Co.  
Stebbins Eng. & Mfg. Co.

## Digesters.

Schaeffer & Budenberg Mfg. Co.  
Swenson Evaporator Co.

## Drainer Bottoms.

Samuel Snell Co.

## Evaporators.

Ernest Scott & Co.  
Swenson Evaporator Co.  
Zaremba Company.

## Exporters.

Parsons Trading Co.

## Felts.

F. Bredt & Co.  
Dallyn, Jardine & Co.  
Hamelin & Ayers Co.  
C. H. Johnson & Sons, Ltd.  
Penman's, Ltd.  
Joseph Porritt & Sons.  
J. H. Spencer & Sons.  
A. P. Tippet & Co.

## Foundriniers Wires.

(See Brass Wire Cloth.)

## Grinders.

Carthage Machine Co.  
H. Fullner.  
Glens Falls Mach. Co.

Holyoke Machine Co.  
Jenckes Machine Co.  
J. M. Voith  
Waterous Engine Works

## Knives.

Crookes, Roberts & Co.  
Peter Hay Knife Co.  
A. P. Tippet & Co.

## Paper Mills.

Canada Coating Mills.  
Canada Paper Co.  
New Brunswick P. & P. Co.  
Rolland Paper Co.  
Riordon Paper Co.

## Paper Presses.

Can. Boomer & Boschert Press Co.

## Paper and Pulp Dealers.

Atterbury Bros.  
Albert E. Mallandain.  
Castle, Gottheil & Overton  
Churchill & Sim  
Howell Co.  
International Process Co.  
Parsons Trading Co.  
Pulp and Paper Trading Co.

## Paper Stock, Rags, Etc.

Atterbury Bros., Inc.  
J. Christie Co.  
R. Hough  
The Howell Co.  
E. Pullan  
J. R. Walker & Co.

## Paper and Pulp Mill Machinery.

Appleton Machine Co.  
Beloit Iron Works  
Bentley & Jackson  
James Bertram & Son, Ltd.  
Bertram's, Limited  
The Black-Clawson Co.  
Canadian Boving Co.  
Carthage Machine Co.  
Chambers & Simpson  
Dillon Machine Co.  
Emerson Mfg. Co.  
Farrel Foundry & Machinery Co.  
H. Fullner.  
Julius Fischer  
Glens Falls Machine Wks.  
Green Bay Barker Co.  
Harmon Machine Co.  
J. H. Horne & Sons Co.  
Holyoke Machine Co.  
Jenckes Machine Co.  
E. D. Jones & Sons Co.  
C. H. Johnson & Sons, Ltd.  
Marx, J. & Co.  
Jas. Milne & Sons  
Moore & White Co.  
B. F. Perkins & Son



Rice, Barton & Fales  
 Ryther & Pringle  
 Sandy Hill Iron & Brass  
 Works  
 Ernest Scott & Co.  
 Sherbrooke Machinery  
 Co., Ltd.  
 S. Morgan Smith Co.  
 Stebbins Engineering &  
 Mfg. Co.  
 H. F. Storrer  
 Swenson Evaporator Co.  
 Ticonderoga Machine  
 Works  
 Valley Iron Works  
 J. M. Voith  
 Charles Walmsley & Co.  
 Chr. Wandel  
 Wandel Screen Mfg. Co.  
 Waterous Engine Works  
 Co., Ltd.  
 P. P. Westbye  
 West End Engine Wks. Co  
 Zarembo Co.

**Paper Testers.**  
 Dobler & Mudge.

**Pipes (Wooden).**  
 National Pipe & Foundry  
 Co., Ltd.

**Pumps.**  
 Can. Boving Co.  
 Carthage Machine Co.  
 Dillon Machine Co.  
 Lawrence Machine Co.  
 Lawrence Pump & En-  
 gine Co.

John McDougall Caledon-  
 ian Iron Works.  
 Smart-Turner Mach. Co.

**Rosin Size.**  
 Paper Makers Chemical  
 Co.  
 Vera Chemical Co.  
 Wilson-Paterson Co.

**Scales.**  
 Alfred H. Mardon

**Screen Plates.**  
 Union Screen Plate Co. of  
 Canada

**Screens.**  
 Glen Falls Machine Wks.  
 Harmon Machine Co.  
 Sherbrooke Machinery Co.  
 J. M. Voith.  
 Chr. Wandel  
 Wandel Screen Mfg. Co.  
 Waterous Engine Works  
 P. P. Westbye

**Slitters and Re-Winders.**  
 H. Fullner  
 Moore & White Co.  
 Ticonderoga Mach. Co.

**Sulphur.**  
 Union Sulphur Co.

**Talc.**  
 Geo. H. Gillespie Co.

**Tanks.**  
 John McDougall Caledon-  
 ian Iron Works

**Transmission Machinery.**  
 H. W. Caldwell & Son Co.  
 Jones & Glassco  
 Dodge Manufacturing Co.

**Travelling Cranes.**  
 Hugh R. Blethen  
 Northern Crane Co.  
 Smart-Turner Mach. Co.

**Turbines.**  
 J. M. Voith  
 S. Morgan Smith Co.

**Water Wheels.**  
 John McDougall Caledon-  
 ian Iron Works  
 Holyoke Machine Co.

**Wood Pulp Agents.**  
 Castle, Gottheil & Over-  
 ton  
 Churchill & Sim  
 Parsons Trading Co.  
 Scandinavian Amer. Trad-  
 ing Co.

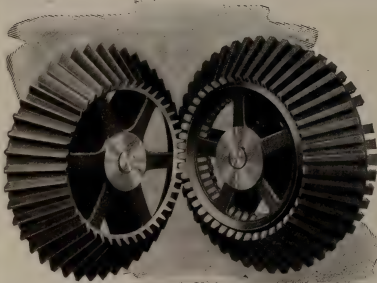

## Mortise Wheels, Spur, Bevel and Miter

Castings of semi-steel by  
 our improved method of  
 machine molding, thus in-  
 suring uniform tooth spacing,  
 true rims and smooth run-  
 ning with high efficiency.

Teeth of both mortise wheel and pinion finished by accurate gear  
 cutting machinery. Designers and builders of water wheel harness.

Send for Catalogue No. 34

# H. W. CALDWELL & SON CO.

50 Church Street  
 NEW YORK

17th St. and Western Ave.  
 CHICAGO

# J. H. Horne & Sons

COMPANY

Lawrence - - - Mass.

---

---

MANUFACTURERS OF  
**PAPER MILL  
MACHINERY**

---

---

Fourdriniers  
Cylinders and  
Wet Machines  
Improved Horne Engines

Horne Jordan Engines  
Double Bevelled Roll Bars  
Horne Friction Cullers  
Barbed Jordan Bars

SEND FOR CATALOGUE

**Order Your  
PAPER AND COTTON CALENDER  
ROLLS**

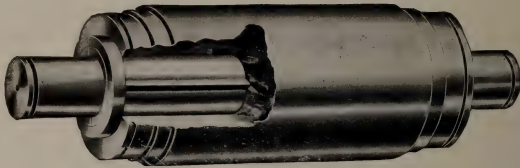

*From*

**B. F. PERKINS & SON, INC.**

HOLYOKE, MASS., U.S.A.

**FROZEN PULP AND DRY PULP  
IN A**

## Ryther Shredder

Is shredded at the rate of 5 tons per hour.  
17 to 25 H. P. required. The above figures are  
*dry weight* and absolutely guaranteed.

RELIEVE YOUR BEATERS and INCREASE QUALITY  
and PRODUCTION. Write for full Particulars.

---

**Ryther & Pringle Company**  
Carthage, N.Y.

# TURBINE PUMPS

SPECIALLY DESIGNED FOR

# PAPER MILL WORK

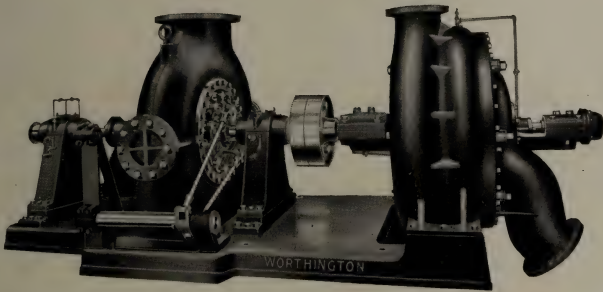

Turbine Pump, capacity 4,000  
U. S. gals. against head of 340  
ft., driven by water wheel, 600  
h.p. at 1,000 r. p. m.

**THE JOHN M<sup>C</sup>DOUGALL  
CALEDONIAN IRON WORKS CO.  
LIMITED**

**WORKS—WILLIAM AND SEIGNEURS STREETS, MONTREAL**

**PRESTON'S**

# Lining for Sulphite Digesters

TOTAL THICKNESS ONLY  $2\frac{1}{2}$  TO  $2\frac{3}{4}$  INCHES

Resists the action of the acid and ensures absolute protection to the Digester Plates.

Great durability, therefore large saving in upkeep and repairs.

Larger internal space and increased production on account of the small thickness occupied.

Extensively adopted by Scandinavian and Continental Mills.

Over 200 Digester Linings in work and on order.

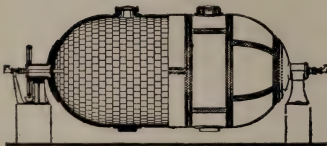
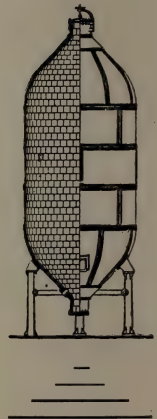

Telegraphic Address :

**"PRESTONS, RADCLIFFE."**

CODE USED A. B. C., 4TH & 5TH EDITION.

*Full Particulars and Prices on application to SOLE MANUFACTURERS*

**PRESTON'S DIGESTER LINING CO., LIMITED**

**RADCLIFFE, near Manchester, Eng.**



---

---

FARREL FOUNDRY AND MACHINE  
COMPANY

ANSONIA, CONN., - - U. S. A.

Largest Manufacturers in the world of

**CHILLED ROLLS**

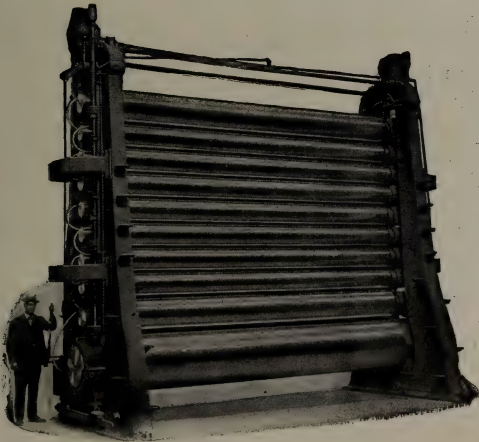

**CALENDERS**

*WITH PATENT HYDRAULIC LIFT*

**ROLL GRINDING MACHINES**

---

---

Would YOU like to enlarge your Business and find new Customers in all parts of the world? If so, ADVERTISE in

# “THE PAPER-MAKER AND BRITISH PAPER TRADE JOURNAL.”

THE LEADING AND MOST POPULAR TRADE ORGAN.

THE ADVERTISER  GOOD FOR  THE READER

We recently received the following letter:—

“We have hesitated over the matter, as we are at present so busy as to regard further advertising as almost superfluous.

“On the whole, however, we find it pays us better to have to refuse orders than to hunt after them, and will ask you therefore to insert our advertisement on same terms as last.

“We enclose herewith amended matter for advertisement, and shall be glad to have proof of same at your early convenience.”

We are constantly in the receipt of gratifying letters relative to the usefulness of our Journal, and we have pleasure in printing the following:

“Gentlemen,

We beg to advise that we have not as yet received the June number of ‘THE PAPER-MAKER AND BRITISH PAPER TRADE JOURNAL.’

We like the publication so well that we should be very sorry indeed to miss a copy of it.

Thanking you in advance for your kind attention,

We are, dear Sirs, yours very truly,  
F. R. KEYES & SON.  
20 Broad Street, New York.”

## S. C. PHILLIPS & Co.'s STANDARD PUBLICATIONS

### The Paper-Maker

AND BRITISH PAPER TRADE JOURNAL.

Published on the 1st of each month. Price 1s., by post 1s. 6d. Annual Subscription 12s. 6d. post free.

**The Stationery World,  
Printing and Allied Trades,  
AND FANCY GOODS REVIEW.**

Published on the 25th of each month. Price 6d. by post 7jd. Annual Subscription 5s. post free.

Chief Offices:

47 CANNON STREET, LONDON, E.C. (ENGLAND).

### The Paper Box and Bag Maker.

Published on the 19th of each month. Price 6d., by post 7jd. Annual Subscription 6s. 6d. post free.

**Phillips' Paper Trade Directory  
of the World.**

15s. 6d., post free to all countries.

NEW EDITION FOR 1911 NOW READY.

Specimen Copies and Advertisement Rates  
FREE OF APPLICATION.

# PAPER and CLOTH Specialties

*For Rent and Club Cards, Pattern Cards, Map Printing, Label Printing, Envelopes, etc., etc.*

Cloth Lined Papers. Cloth Centred Papers and Boards. Cloth Lined, Chromo and Enamel. Cloth Lined Boards and Cards (surfaced and enamelled). Cloth Centred Boards (surfaced and enamelled). Manilla Surfaced Boards and Cards.

**Also Enamelled Blotting. Art Papers. Paste Boards. Chromo and Surface Papers**

Customers' requirements in specialties are carefully considered and experiments conducted if necessary.

---

**ALBERT E. MALLANDAIN**

OFFICES: 51 Cheapside  
London, E.C.

MANUFACTURER

MILLS: Park Royal  
Willesden, London, N.W.

**E. H. WILKINSON**

Telephone Building  
82 Adelaide Street West  
Toronto

*Sole Agent for Canada*

Telephone Main 1716  
Cable Address: *Faultless*

---

# HERMANN FINCKH

REUTLINGEN

*Established 1879*

GERMANY

---

# FOURDRINIER WIRES

---

## SULPHITE - MACHINE WIRES CYLINDER WIRES

---

**P. P. WESTBYE, - Peterborough, Ontario**

*Sole Agent for Canada*

## WANT AND FOR SALE ADVERTISEMENTS

**PULP MILL CHEMIST** with twelve years' experience in Sulphite (Bleached and Unbleached), wants similar position, good draughtsman. Apply Box 30, Pulp and Paper Magazine.

**UNDER MANAGER.**—Young man, 14 years' practical experience in English mill making long elephants, news, all-wood printings, cream laid, etc. Experienced mill chemist—testing of papers, fibres, etc. Highest references. Address H. C., c/o Pulp and Paper Magazine.

**WANTED IMMEDIATELY.**—Master mechanic, machinists, millwrights, and pipefitters for Canadian soda, pulp and paper mill now under construction. Only experienced men need apply. State wage and give references. Apply Box D, Pulp and Paper Magazine.

**AGENT WANTED,** by a London firm of Paper Merchants wishing to extend their business in Canada. All classes of English and foreign papers handled. Address with full particulars and references to Box 31, c/o Pulp and Paper Magazine.

**SUPERINTENDENT** for 25-ton mill making special papers, located in Province of Quebec. Give full details. Care of R. A. H., Pulp and Paper Magazine.

**WANTED.**—Superintendent for a new 150-ton ground wood mill. One with technical education preferred. Please state education and experience in full; also give age, if married or single, and salary asked for. Address Box 27, care Pulp and Paper Magazine, Toronto.

### FOR SALE.

**BELTING.**—1,000,000 ft. New Leather Rubber and Cotton Belting; 500,000 feet Iron Pipe; large stock of Pulleys, Shaftings, Hangers, Saws, Wire Fencing, Roofing, Rails, etc. Catalogue on request. Price 25 to 75% cheaper than elsewhere. The Imperial Waste and Metal Co., 105 Queen St., Montreal, Que.

**FOR SALE.**—Special Second-hand cylinder mould, 48-in., diameter 84-in. face. Good as new. Can be used as Filter. For particulars, etc., address Box 32, Pulp and Paper Magazine.

As we are using all our Water Power at our Pulp Mill for electricity, we are disposing of the Pulp Mill Machinery—including Millard Patent Grinders which were in use only a few months and are absolutely as good as new, also Wet Machines, Barkers, Screens, Pumps, Piping, Shafting, Stones, etc., etc., all in good condition. Full information will be given upon application.

Apply Box "A,"

Pulp and Paper Magazine.

**Messrs. Vickery's Patents Limited** are open to appoint agents for Canada for the Vickery Patent Lay Boys. Only firms in touch with paper mills suitable. Apply first instance Vickery's Patents Limited, 428 Frost Avenue, Rochester, N. Y.

**THE PAPERMAKERS' POCKET BOOK**—By James Beveridge—Specially compiled for Paper Mill Operatives, Engineers, Chemists and Officials. Price \$3.50. Biggar-Wilson, Ltd., Toronto.

SCOTT'S IMPROVED RECOVERY SYSTEMS  
FOR  
**SODA, SULPHATE & SULPHITE**

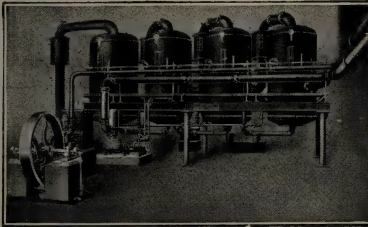

Spent Liquors give the  
MAXIMUM ECONOMY  
AND EFFICIENCY

The PRINCIPLE,  
The DESIGN,  
The CONSTRUCTION,  
The OPERATION,  
The RESULT,

**Is RIGHT**

Complete installations made by "THE FIRM WITH THE EXPERIENCE."

**ERNEST SCOTT & CO.** Manufacturing  
Engineers

FALL RIVER, MASS. and MONTREAL, P.Q.

**SODA OR SULPHATE**

RECOVERY SYSTEM  
MAXIMUM EFFICIENCY      MINIMUM LOSSES

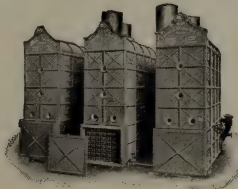

WELDED DIGESTERS      MULTIPLE EFFECT EVAPORATORS  
AND OTHER PULP MILL EQUIPMENT

**SWENSON EVAPORATOR CO.**

945 Monadnock Bldg. . . . CHICAGO



*People who are wise Advocate Forestry*

# The American Forestry Magazine

IS DEVOTED TO SECURING

**Better Fire Protection  
Fair Forest Taxation  
Lower Freight Rates**

**Proper Legislation  
Conservative Management  
and Reforestation**

It should be on the desk of every progressive American citizen. It is the public service publication of the American Forestry Association

AMERICAN FORESTRY MAGAZINE, ONE YEAR - \$2.00  
Membership in American Forestry Association, One Year - \$1.00

Address AMERICAN FORESTRY ASSOCIATION  
Washington, D.C.

## A GOOD JORDAN ENGINE

BUILT IN 3 SIZES.



## THE BLACK-CLAWSON CO.

HAMILTON, OHIO, U.S.A

Builders of **PAPER MAKING MACHINES** and machinery for Paper and Pulp Mills. Our machines are completely erected in shop on cast iron levelling plates and carefully inspected before shipment.

*Write for Catalogue.*

VALLEY IRON



WORKS COMPANY

# BEATING AND WASHING ENGINES

IRON OR WOOD TUBS

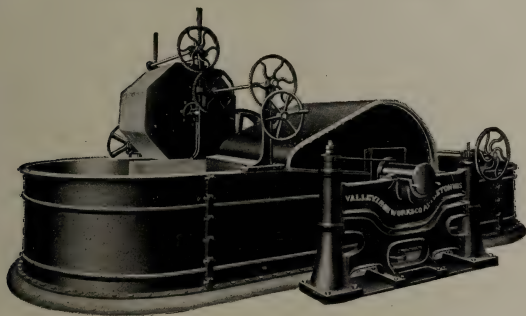

*Perfection in Every Detail*

Beating, Washing and Bleaching Engines. Barkers—Barker Attachments  
—Chippers—Rechippers—Chip Screens (Revolving)—  
Knot Screen (Revolving)—Diaphragm Screens—Felt Washers— Deckers  
(Single and Double)—Stuff Chests (Vertical and Horizontal)—  
Tanks (Blow Off, Acid and Water)—Pulpwood Saws (Friction and  
Steam Feed)—Pulpwood Splitters (Vertical and Horizontal)—  
Shredders and Special Washers for old Paper Stock—Wet Machines and  
Patent Roll Skinners—Bronze, Semi-Steel, Lead and Iron Castings.

Manufacturers of Paper and Pulp Making Machinery in

*All Standard Forms — Many Special Designs*

**ENGINEERS, FOUNDERS AND MACHINISTS**

*Correspondence Invited*

**VALLEY IRON WORKS COMPANY**

**APPLETON, WIS., U.S.A**

# TOWNSEND

## ELECTROLYTIC CELL

2,500-5000 AMPERE UNITS. ALKALI AND CHLORINE.  
CAUSTIC SODA. BLEACHING POWDER. CHLORINE  
FOR ORES. LICENSES GRANTED. CANADIAN PATENTS  
91939 - 105088 - 105089.

**HOOKER ELECTROCHEMICAL COMPANY**  
40 WALL STREET, NEW YORK

REGISTERED



JOHN KNIGHT, Pres. C. K. WILLIAMS, Treas. C. H. KNIGHT Sec.

## Paper-Makers Chemical Co.

FROM MINE TO MILL

**ENGLISH CHINA CLAYS  
MANUFACTURERS**

**Excelsior Felt Cleaner**

GBB Brand China Clay is  
a natural pure white, no artificial tinting  
Unsurpassed for  
coating, bleaching, or fine papers.

Superior Rosin Size

Superior Satin White

**EASTON, PA., U.S.A.**

## Paper Coating and Colouring Machines

COMPLETE PLANTS AND ACCESSORIES

The best in the world.

To be obtained from

**Julius Fischer** Engineering Works **Nordhausen, H.**

GERMANY

*Excellent References in all countries.*

## THE PETER HAY KNIFE CO., Limited, GALT, ONT.

MACHINE  
KNIVES,  
CHIPPER,  
BARKER &  
PAPER-  
CUTTER  
KNIVES.

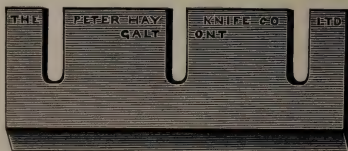

Made from the Best English Steel and Warranted.

Established  
1869

**CHR. WANDEL**

Established  
1869

REUTLINGEN

GERMANY

Paper Machine Wire and Engineering Works

SOLE MANUFACTURER OF

The Original "WANDEL" Rotary Screen

Over  
3,000  
Apparatus  
Sold

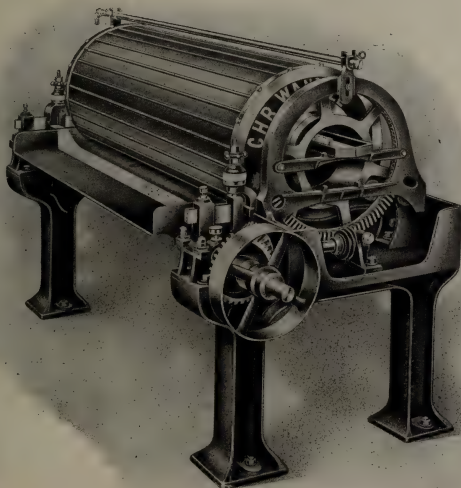

No authorized  
builder in  
Canada  
or the States

**ADVANTAGES :** *Regular output of pulp. Large working ability. Automatic removal of knots. Avoidance of stoppage. Less power. Great strength and durability. Suitable for all classes of paper.*

ESTIMATES PROMPTLY FURNISHED, DELIVERED AT ANY POINT

---

SOLE CANADIAN AGENTS

**ARTHUR P. TIPPET & CO.**

8 Place Royale

Montreal, Que.

# CROOKES, ROBERTS & Co.

SHEFFIELD

ENGLAND

Makers of

Makers of

Crucible Cast Steel

Bessemer Cast Steel

Bed Plates

Crookes'

Jordan Fillings

Composition

Beater Bars

Fillings



And every description of Cutter Knives, Tools and Steel used  
and required in Paper Mills.

**ARGUS** High-Speed **STEEL** for fine machine tools is  
unsurpassed.

Once Used - Always Used

**YOU SAVE MONEY USING "ARGUS" GOODS**

WRITE US

**ARTHUR P. TIPPET & CO.**

Agents for Canada

MONTREAL

# SPENCER'S

ALWAYS



RELIABLE

Best Wool - Best Weave - Best Wear

**J. H. SPENCER & SONS**

BURY

ENGLAND

Canadian Agents: **ARTHUR P. TIPPET & CO., MONTREAL**



# INDEX TO ADVERTISEMENTS.

(SEE CLASSIFIED ADVERTISERS INDEX ON PAGE XXXI.)

Ambursen Hydraulic Construction Co. . . . .	lxv	Dillon Machine Co. . . . .	xiv
American Forestry Association . . . . .	xliv	Dodge Mfg. Co. . . . .	iv
Appleton Machine Co. . . . .	iv	Dominion Belting Co. . . . .	xlviii
Atterbury Bros. Inc. . . . .	lxii	Eaton & Brownell . . . . .	lviii
Becker & Co. . . . .	xxvi	Emerson Mfg. Co. . . . .	xxv
Beloit Iron Works . . . . .	xliii	Farrell Foundry & Machine Co. . . . .	xxxvii
Bentley & Jacskon . . . . .	v	Ferguson, H. S. . . . .	lviii
Bertram, James & Son, Ltd. . . . .	xviii	Fischer, Julius . . . . .	xliv
Bertram's, Limited . . . . .	vi	Finckh, Hermann . . . . .	xxxix
Black-Clawson Co., The . . . . .	xlii	Fullner, H. . . . .	xxx
Blethen, Hugh R. . . . .	lix	Garland, M. Co. . . . .	xii
Bredt & Co., F. . . . .	lii	Gewerkschaft, Sachtleben . . . . .	lxiii
Brunner, Mond & Co., Limited . . . . .	lxvi	Gillespie, Geo. H. Co. . . . .	lxv
Caldwell, H. W. & Son, Co. . . . .	xxxii	Glens Falls Machine Works . . . . .	xlx
Canada Coating Mills, Limited. . . . .	lvii	Green Bay Barker Co. . . . .	xxi
Canada Paper Co., Ltd. . . . .	lvii	Hamelin, The, & Ayers Co., Ltd. . . . .	lx
Canadian Boomer & Boschert Press Co. . . . .	lx	Hardy, Geo. F. . . . .	lviii
Canadian Boving Co. . . . .	lv	Harmon Machine Co. . . . .	viii
Carthage Machine Co. . . . .	xxiv	Hay Knife Co., Peter, Limited . . . . .	xliv
Castle, Gotthel & Overton . . . . .	lii	Holyoke Machine Co. . . . .	xvi
Chambers & Simpson . . . . .	vi	Hooker Electrochemical Co. . . . .	xliv
Chicoutimi Pulp Co. . . . .	xxvi	Horn, J. H. & Son . . . . .	xxxiii
China Clay Co. . . . .	l	Hough, R. . . . .	lxvi
Christie, J. Co. . . . .	lxvi	Howell Co., The . . . . .	xlviii
Christie, Limited, George . . . . .	lxv	International Process Co. . . . .	ii
Churchill & Sim . . . . .	lxii	Jeffrey Mfg. Co. . . . .	iii
Crookes, Roberts & Co. . . . .	xlvi	Jencks Machine Co. . . . .	xvii
Crossley, T. L. . . . .	lviii	Joncken & Sons, Limited, C. H. . . . .	xlix
Dallyn, Jardine & Co. . . . .	lii		
De Cew, J. A. . . . .	lix		

## HYDRAULIC TURBINES

One unit of six with a total capacity of 13,100 Horse Power furnished for the new plant of J. R. Booth, Ottawa, Ontario. We build Turbines for any power for heads from 3 to 600 feet.

WRITE FOR CATALOGUE



**S. MORGAN SMITH CO.,**  
**YORK - PA.**

Jones, E. D. & Sons Co. ....liv  
 Jones & Glassco .....xx  
 Kimball, Herbert S. ....lviii  
 Klipstein & Co., A. ....l  
 Lawrence Machine Co. ....xx  
 Lawrence Pump & Engine Co. ....lii  
 Lea, R. S. & H. S. Ferguson .....lviii  
 Little, Arthur D. Inc. ....lviii  
 Lyford, Clark & Lyford .....lviii  
 Mallandain, Albert E. ....xxxix  
 Marx, J. & Co. ....viii  
 Mardon, Alfred H. ....lx  
 McDougall, John, Caledonian Iron Works  
 Co., Limited .....xxxv  
 Meincke, C. A. & Co. ....l  
 Milne, Jas., and Son .....xxvii  
 Moore & White Co. ....xv  
 National Pipe & Foundry Co., Ltd. ....l  
 New Brunswick Pulp and Paper Co.,  
 Limited .....lv  
 Northern Crane Works, Ltd. ....lxvi  
 Panzl Digester Lining Co. ....lvi  
 Paper Makers Chemical Co. ....xliv  
 Parsons Trading Co. ....xxiv  
 Penmans Limited .....lii  
 Perkins, E. F. & Son .....xxxiv  
 Phillips, S. C. & Co. ....xxxviii  
 Porritt & Son, Joseph .....lii  
 Porritt Bros. & Austin .....xlix  
 Prather, H. B. ....lix  
 Preston's Digester Lining Co. Ltd. ....xxxvi  
 Pride, Chas. B. ....lix  
 Pringle, T. & Sons .....lviii  
 Pullan, E. ....liv  
 Pulp & Paper Trading Co., The. ....lx  
 Reddaway, F. & Co. ....liv  
 Rice, Barton & Fales .....li

Riordon Paper Co., Limited .....lvii  
 Rolland Paper Co., .....lv  
 Ryther & Pringle .....xxxiv  
 Sadler & Haworth .....liii  
 Sandy Hill Iron & Brass Works .....x  
 Scandinavian American Trading Co. ....xxix  
 Schaeffer & Budenberg Mfg. Co. ....liv  
 Scottish Wirecloth Co. ....xlvi  
 Scott, Ernest & Co. ....xli  
 Sherbrooke Machinery Co., Limited. ....xix  
 Smart-Turner Machine Co. ....lxvi  
 Smith, S. Morgan, Co. ....xlvi  
 Snell, Samuel Co. ....l  
 Spencer, J. H. & Sons .....xvi  
 Stebbins Engineering & Mfg. Co. ....lix  
 Sweezy, R. O. & W. G. ....lviii  
 Swenson Evaporator Co. ....xli  
 Taylor, J. A. ....lxv  
 Ticonderoga Machine Works .....e.o.m.  
 Tippet, Arthur P. & Co. ....xxv-xlv-xlvi  
 Union Screen Plate Co. ....iii  
 Union Sulphur Co., The. ....lxi  
 United Wire Works, Limited .....xxv  
 Valley Iron Works .....xliii  
 Vera Chemical Co. ....lxii  
 Voith, J. M. ....vii  
 Walker, J. R. & Co. ....lxii  
 Wallace, Jos. H. & Co. ....lix  
 Walmsley, Charles & Co. ....xxii-xxiii  
 Wandel, Chr. ....xlv  
 Wandel Screen Mfg. Co. ....lix  
 Waterous Engine Works Co., Ltd. ....lxix  
 Westbye, P. P. ....xi-xxxix  
 West End Engine Works Co. ....x  
 Wilkinson, E. H. ....xxxix-lvi  
 Wilson-Paterson Co. ....xxiv  
 Winn & Holland .....lxvi  
 Zarembo Co. ....lxiii

*Scandinavian Sulphite  
 and Ground Wood  
 Kraft Pulp  
 Bleached Sulphate  
 and Sulphite  
 Austrian Bleached  
 Mitscherlich*

Limited quantities still available  
 Write us for quotations and  
 quantities

**THE HOWELL CO.**  
 8-10 Wellington St. East  
**TORONTO - CANADA**

**MAPLE LEAF**  
**STITCHED COTTON DUCK**  
**BELTING**  
**DOMINION BELTING CO. LTD.**  
**HAMILTON CANADA**

**The Scottish Wirecloth**  
 Company, Limited  
**LEITH - SCOTLAND**

Wirecloth for Paper Machines, etc.

# Glens Falls Machine Works

GLENS FALLS, N.Y.



Sole Manufacturers of  
**Tromblee & Paull Rotary Sulphur Burner**  
**The Moore Rotary Screen**  
**The Reynolds Screen**

Also Manufacture  
**Cedar Point Foundry Grinders**  
**Improved Standard Grinders**  
**Improved Wet Machines**  
**Rotary Pumps, etc.**

Write for Particulars and Specifications—they are free.

## C. H. JOHNSON & SONS, Ltd.

WIRE WORKS, ST. HENRY, MONTREAL.

MANUFACTURERS OF

**Fourdrinier Wires, Cylinder Wires,**  
**Brass, Copper and Iron Wire Cloth, Dandy Rolls**

## PORRITT BROR. & AUSTIN

Stubbins Vale Mills—RAMSBOTTOM—near Manchester, England

Manufacturers of every description of

**FELTS AND JACKETS FOR**  
**PULP AND PAPER MILLS**

Agents for Canada: C. H. JOHNSON & SONS, Ltd., ST. HENRY, MONTREAL

**WE MANUFACTURE Wooden Water Pipe** for Water Works Systems. **Specially Made Pipe** for conveying Chemicals. **Continuous Stave Pipe** or Power Plants.  
 Sizes from 2 inches to 12 feet diameter.

**NATIONAL PIPE AND FOUNDRY CO., LIMITED**  
 Works—ALEXANDRIA, Ont. 135 Board of Trade Bldg., MONTREAL, Que.

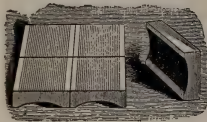

### Use Snell's Drainer Bottoms

They drain quickly and don't let the Pulp go into River. **No Dust. No Splinters. Clean Stock.**  
*Send for Sample and Price*

**Samuel Snell Co., - Holyoke, Mass.**

Cable Address:—"Kaolin, Manchester." A.B.C. Codes 4th & 5th Edition

# CHINA CLAY CO.

JOHN WILLIAMSON, Manager.  
 4 St. Anne's Square

**MANCHESTER, ENG.**

**MINES**—Ruddle, Bojea, Colchester, South Ninestones, Tronance, St. Austen Cornwall.

**CONTRACTORS TO H.M. INDIAN GOVERNMENT**

Canadian Representatives—C. A. Meincke & Co., 222 Coristine Bldg., Montreal.

## A. KLIPSTEIN & Co. Ltd.

(OF CANADA)

12 ST. PETER ST. - - MONTREAL

# SULPHATE ALUMINA

**CHINA CLAY, BLEACH and CASEIN  
 PAPER BLUE, both Basic and Acid  
 AURAMINE - RHODAMINE**

and all other Aniline Colors

Shades Carefully Matched in our Laboratory Mention Pulp & Paper Magazine

New York Office - 644-654 Greenwich Street.

THE PROCESSES AND APPARATUS  
THAT MADE "KRAFT PAPERS" SUCCESSFUL



CABLE ADDRESSES  
KRAFTLICH, NEW YORK.  
IMPROKRAFT, LONDON.

# INTERNATIONAL PAPER PROCESS CO.

EUROPEAN OFFICES  
SALISBURY HOUSE,  
LONDON, ENGLAND.

AMERICAN OFFICES  
5 BEEKMAN STREET  
NEW YORK, N.Y.

SOLE AGENTS IN NORTH AMERICA  
FOR  
CARL P. CARLSON, SWEDEN.  
EVAPORATORS AND LIQUOR SYSTEMS.

JULIUS PINTSCH, ACTIENGESELLSCHAFT, GERMANY.  
DIGESTERS, DIFFUSERS AND SPECIALTIES.

SWEDISH SYSTEM OF RECOVERY FOR  
TURPENTINE, ALCOHOL AND OTHER BY-PRODUCTS.

ENGINEERS, CHEMISTS, PULP EXPERTS.



**LAWRENCE PUMP  
AND ENGINE CO.**

P. O. BOX 70, DEPT. 10  
LAWRENCE :: MASS.

**CENTRIFUGAL PUMPS**

We make an exclusive specialty of High Efficiency Centrifugal Pumps for Paper and Pulp Mill. In one mill 49 of our Pumps are running, the customer writes—"Your Pumps are all giving perfect satisfaction."

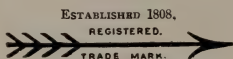
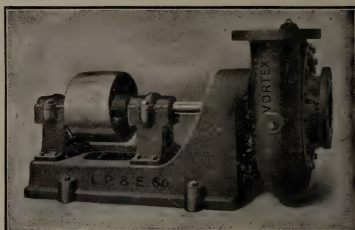

**FELTS** For Pulp and Paper Mills.

**JOSEPH PORRITT & SONS**

Agents for  
Canada  
and United  
States.

**HELMSHORE**  
Manchester, England.

All kinds  
Woollen, Lin-  
en and Cotton  
Cloths for  
Mechanical  
Purposes.

**F. BRETT & CO., 240 Water Street, NEW YORK.**

**PENMANS LIMITED**  
ST. HYACINTHE, QUEBEC

Manufacturers of  
**PULP AND PAPER MAKERS' FELTS,  
JACKETS, STRAINER CLOTHS, ETC.**

Special sizes and qualities made to order. Satisfaction guaranteed.  
**DALY, JARDINE & CO. TORONTO Selling Agents**

**CASTLE, GOTTHEIL & OVERTON**

**200 Fifth Avenue, New York**

**AGENTS FOR**

**Sulphite and Wood Pulp Mills**

Dealers in all kinds of Paperstock, Sizing, etc.

Correspondence Solicited.

If You Use

# "AMPHIBIA"



(WATERPROOF)



## Leather Belting

You get more out of your belt per dollar invested than with any other. The reason is simply that "AMPHIBIA" is made to last longer and

it costs less per day of  
service

It is, therefore, the least expensive belt altho not necessarily the cheapest (first cost).

### Sadler & Haworth

Tanners and Manufacturers

MONTREAL  
511 William Street

TORONTO  
27 Melinda Street

ST. JOHN, N.B.  
89 Prince William Street

WINNIPEG  
244 Princess Street

VANCOUVER  
217 Columbia Avenue

For over thirty-five years the  
makers of the best leather belts



Nearly FIFTY YEARS ago we introduced this Belt. IT HAS STOOD THE TEST OF TIME

2" to 24" in stock

Every Belt is  
Stamped with  
Trade-Mark.

SOLE MAKERS



Write or phone us

Beware  
of Imitations

F. REDDAWAY & CO.,

MONTREAL, CANADA.

**E. PULLAN,** 490 Adelaide St. W., **TORONTO**

Largest Paper Stock Dealer in Canada

**RAGS AND PAPER STOCK GRADED TO SUIT MILL REQUIREMENTS**

**Correspondence Solicited.**

EDWARD A. JONES, President and Treasurer

WALLACE E. BARDWELL, Secretary

**E. D. JONES & SONS CO.,** Pittsfield, Mass.

Manufacturers of

**PAPER MAKING MACHINERY  
AND MECHANICAL ENGINEERS**

Beating Engines. Washing Engines. Mixing Engines. Bleaching Engines.  
Cooking Engines. Vertical and Horizontal Stuff Chests.

Jordan Engines of three sizes, either belt or direct connected motor driven;  
fillings of Wagg Steel or stone type, three-part or plain.

Dusting Machinery of all kinds.



## Just the Gauge for Sulphite and Pulp Digesters

When using ordinary pressure gauges on digesters the space beneath the spring is liable to become clogged thereby rendering the gauge worthless.

In the S. & B. diaphragm gauge shown above this trouble is eliminated by a special detachable bottom (see A in sketch). This allows of a periodical cleaning thereby keeping the gauge always accurate.

The S. & B. diaphragm gauge for digesters is furnished with a corrugated steel diaphragm spring having a platinum protection plate of same corrugation. The lower portion of the gauge is made of phosphor bronze. These features render the gauge absolutely acid proof.

Write for Pamphlet Q 21 and Prices

**THE SCHAEFFER & BUDENBERG MFG. CO.**

CHICAGO

BROOKLYN, N.Y.

PITTSBURG

# "C.B.C." REFINER

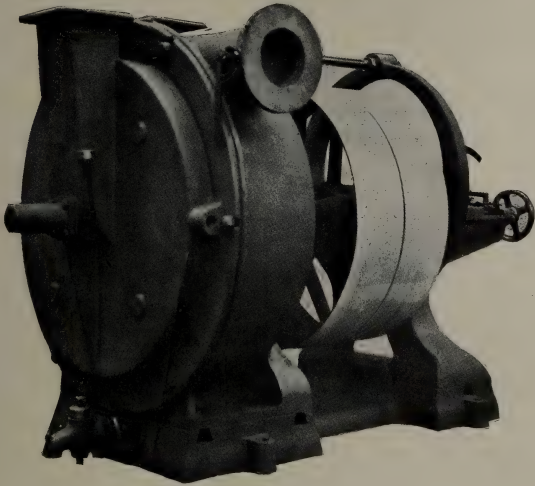

*Great strength and durability.*

*Large working capacity.*

IT SAVES YOU ALL YOUR SCREENINGS  
i.e., 5 to 10 per cent. of your wood consumption  
IT INCREASES YOUR PRODUCTION  
5 to 10 per cent. without additional power

## The Canadian Böving Co., Limited

164 BAY ST.

- -

TORONTO

## THE ROLLAND PAPER COMPANY

**Paper Manufacturers. Printing and Writing Papers.**

Super-Calendered, Velvet and Machine Finished Book, Litho and Antique Printing, Engine Sized Writing and Envelope Papers, White and Tinted Bond. Typewriter Papers (Glazed and Rough Finish). Writing Tablets and Envelopes.

Ask for "Canadian Bond," "Provincial Bond," "Adelia," and "Northern Mills."

Head Office :

Montreal, 53 St. Sulpice Street.

Mills :

St. Adele, Que.

## GENUINE "KRAFT" PAPERS

*Made in Canada*

**THE NEW BRUNSWICK PULP & PAPER CO.**

Springfield Mills, Millerton, N.B. Limited

Ontario Representative - E. H. WILKINSON

Telephone Building, 82 Adelaide Street West - TORONTO

## PANZL'S PATENTED LINING COMPOSITION

IS THE SAFEST AND BEST MATERIAL FOR

**LINING OF SULPHITE PULP DIGESTERS**

AND ACID RECLAIMING TANKS

**PANZL LININGS ARE SAFEST AND MOST DURABLE**

They are really acid-proof and practically indestructible.

All Digesters lined with Panzl's patented composition, now as tight and in as good condition after years of continuous use as they ever were, no leaks and no repairs.

Panzl Linings can be made considerably thinner than the other linings, thus increasing the capacity of the digesters

The composition and the system of constructing of Panzl Linings are patented in all countries where wood pulp is being manufactured by the sulphite process. The PANZL U.S. Patents have been adjudicated to be valid in law and wholly independent of all prior patents relating to linings of digesters.

For information and estimates, address:—

**PANZL DIGESTER LINING COMPANY**

505 Washington Ave., Muskegon, Mich.



## The Riordon Paper Company, Limited

Fibre, Paper, Lumber.

MONTREAL - - CANADA

News Paper, Hanging Paper, Wrapping Paper, Building Paper, Celebrated "Impervious" Spruce Sheathing and Sulphite Fibre for all kinds of Paper.

## THE CANADA COATING MILLS, Ltd.

GEORGETOWN, ONT.



Manufacturers of  
SURFACE COATED BOOK and LITHOGRAPHIC  
PAPERS, COATED CARDBOARD and COATED  
BOXBOARDS of every description.

### "Chalk White" Coated Book Paper.

The best and whitest coated paper sold.

**ALL REGULAR SIZES AND WEIGHTS IN STOCK.**

Our Art Litho Cover Paper is stocked in four tints, 2 sizes. 20 x 25 and 21½ x 28½. Samples gladly sent.

MONTREAL  
TORONTO

**CANADA PAPER CO.**  
LIMITED

WINDSOR  
MILLS, P.Q.

# DIRECTORY

of

## Civil and Chemical Engineers

### T. PRINGLE & SON, Limited

Engineers and Architects

Plans and Specifications for Pulp and Paper Mills, Power Plants and other Industrial Works.  
**Coristine Bldg.; Continental Life Bldg.**  
**Montreal. Toronto.**  
 Bell Tel.: M. 3890. Tel.: M. 5917.

### R. S. LEA, and H. S. FERGUSON, ENGINEERS

Pulp, Paper and Chemical Fibre Mills.  
 Water Power Development and Transmission. Steam Power Plants.  
**Telephone Long Distance Up. 751.**  
**405 DORCHESTER ST. West, MONTREAL**

### Arthur D. Little Inc.

— LABORATORY OF —  
 ENGINEERING CHEMISTRY  
**93 BROAD ST., BOSTON, - MASS.**  
 Our staff includes experts in Papermaking Chemistry  
 —Sulphite Mill Practice—Fuel Engineering.

### GEORGE F. HARDY, M. AM. SOC., M. E. M. CAN. SOC. C. E.

Consulting Engineer.

Paper, Pulp and Fibre Mills, Examination of Mill Properties, Water Power Developments.  
**Mutual Reserve Building, - 309 Broadway, NEW YORK.**

CHARLES E. EATON, M. Am. Soc., M. E. JAMES P. BROWNELL, C. E.

### EATON & BROWNELL, Consulting Engineers and Architects.

Paper, Pulp and Fiber Mills, Water, Steam and Electric Power Development, Examination of Properties, Consultation Reports.  
**SMITH BLDG. WATERTOWN, N. Y.**

ENGINEERS SHOULD WRITE  
 THE PUBLISHERS FOR RATE  
 OF CARDS ON THIS PAGE.

### T. LINSEY CROSSLEY

Engineering Chemist

PULP AND PAPER  
 TECHNOLOGY

**318 Lagauchetiere St., W., Montreal**

### R. O. & W. G. SWEEZEY

— Civil and —  
 Forest Engineers

Limit cruising, surveys, water storage, power, lumbering contracts.

**METROPOLITAN BLDG., QUEBEC**

ASSOCIATED WITH

### HERBERT S. KIMBALL

M. Am. Soc. C. E.

*Mill Architect and Engineer*

**111 Devonshire St., Boston**

### FOREST ENGINEERS

FOREST SURVEYS TIMBER ESTIMATES LOGGING MAPS  
 WATER POWER WATER STORAGE  
 CLARK, LYFORD & STERLING  
 1331 Real Estate Trust Bldg., Philadelphia  
 CLARK & LYFORD LYFORD, CLARK & LYFORD  
 403 Crown Bldg. 26 Board of Trade Bldg.  
 Vancouver. Montreal.

**PULP  
PAPER  
POWER** JOSEPH H. WALLACE & CO.  
INDUSTRIAL ENGINEERS.  
TEMPLE COURT BLDG. NEW YORK.  
SALISBURY HOUSE, LONDON, E.C.  
CABLES, TRIPLEX, N. Y., TRIPLEXIS, LONDON.

**C. B. PRIDE**

**MILL ARCHITECT & ENGINEER**  
**PAPER, FIBER, AND PULP MILLS, —**  
**— WATER & STEAM POWER DEVELOPMENT**  
 25 YEARS SUCCESSFUL OPERATIONS  
**SPOKANE, WASH OFFICES APPLETON, WIS.**

**J. A. De CEW** M.A. INST. CHEM. ENG. *Chemical Engineer*  
 A.M. CAN. SOC. C.E.  
 Paper Mill Analysis Pulp Testing Investigations  
 Sulphite Fibre, Soda Fibre Reports  
**CANADIAN EXPRESS BUILDING - - - MONTREAL**

Power, Lighting, Heating, Ventilating and Drying.—Complete New Plants, Improvement of Old Plants;  
 Plans, Specifications, Contracts, Estimates, Tests, Appraisals, Inspections and Reports.—Pulp, Paper,  
 Box Board and Coating Mills.

**H. B. PRATHER,**  
*CONSULTING ENGINEER,*

Lowest Possible Operating Cost. **ROCKFELLER BLDG., CLEVELAND, O.** Guaranteed Results.

**HUGH R. BLETHEN**  
**21 PARK ROW, - - - NEW YORK, N.Y.**  
 Traveling Cranes - Overhead Tramways - Trolleys and Chain  
 Hoists for Paper and Pulp Mills - Power Houses.

**Stebbins Engineering & Mfg. Co.**  
**WATERTOWN, N.Y.**

MANUFACTURERS OF  
 STEBBINS' ACID SYSTEMS, SULPHUR BURNER  
 DIGESTER LININGS, RECLAIMERS, ETC.

Engineering Department under Mr. T. L. TOMLINES Plans, Estimates and Specifications for Paper, Pulp and Fibre Mills, Water Power and Hydro-Electric Developments

# LEUNIG PAPER SCALES

Showing correctly at a glance, by weighing a single sheet, the weight of a ream of Paper of any size, containing either 480, 500, or 516 sheets.

Can also be made to indicate in addition to the English weight, the weight in Kilogrammes.

Illustrated Price List on Application.

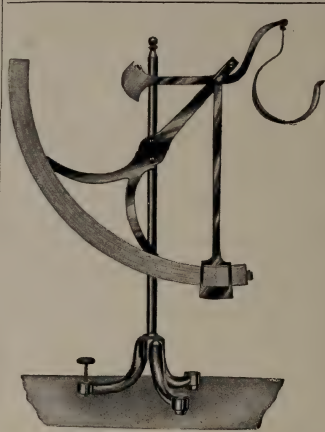

$\frac{1}{2}$  to 80 lbs.

**Price,**  
**Ten Dollars**  
F.O.B., London

$\frac{1}{2}$  to 120 lbs.

**Price,**  
**Fourteen Dollars**  
F.O.B., London

Illustrated Price List on Application.

**Alfred H. Mardon** 150 Shaftesbury Ave. **London, Eng.**

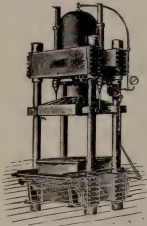

# PULP PRESSES

AND ACCESSORIES

CANADIAN BOOMER & BOSCHERT PRESS  
COMPANY, LIMITED

18 TANSLEY STREET, MONTREAL

"LACHUTE FELTS" Bell Tel. No. 23

# The Hamelin & Ayers Co., Limited

LACHUTE MILLS, P.Q.

MANUFACTURERS OF EVERY DESCRIPTION OF

# FELTS FOR PAPER AND PULP MILLS

"The Best are the Cheapest."

**Q** The new Canadian Pulp and Paper Directory for 1912 is now ready for distribution.

**BIGGAR-WILSON, Ltd.**

PRICE \$3.00

Confederation Life Bldg.

**The PULP & PAPER TRADING CO.**

TEMPLE COURT BUILDING, NEW YORK CITY.

DEALERS IN

**Paper and Pulp of All Kinds.**

Prices and Samples on Application.

## **The Union Sulphur Company**

---

Producers of the Highest Grade Brimstone on the Market

---

Absolutely free from Arsenic, Selenium or Tellurium

---

**The Largest Sulphur Mine in the World**

CALCASIEU PARISH, - LOUISIANA

**Main Offices : Whitehall Bldg., 17 Battery Place**

**NEW YORK**



**WE GUARANTEE OUR SIZINGS TO BE ABSOLUTELY CLEAN  
OUR VERA PAPER SIZE**

is purest, strongest and highest free rosin size made. We can furnish you with an ideal rosin size and patented apparatus to use same.

**OUR VERA MILL SIZE**

is the best soluble paper makers' rosin size made. Ready to use in cold or warm water in the ordinary way without apparatus. Gives better satisfaction and is more economical than mill made size.

Our sizings are cleaned by our new patented process and we guarantee this size to be absolutely clean, without the least speck of impurity in the same, preventing thereby black specks in the paper. We are shipping our size in barrels or tank-cars.

**VERA CHEMICAL COMPANY**

Main Office and Western Factory  
NORTH MILWAUKEE, WIS.

Eastern Factory  
STONEHAM, MASS.

**J. R. Walker & Co.** Importers and Packers of **GRADED RAGS, PAPER STOCK  
ROPE BAGGING, ETC.**

WAREHOUSE, 35 COMMON ST., MONTREAL.

Also Manufacturers of Roofing and Building Papers. Leatherboard and Friction Board

Mills at Sault au Recollet, P.Q.

**ATTERBURY BROTHERS, Incorporated.**

*Importers and Exporters.*

**Wood Pulp,** FOREIGN AND DOMESTIC **Rags AND Paper Stock**

Potter Building, 145 Nassau Street, New York City.

Cable address "AFFECTIVE," New York.

**CHURCHILL & SIM**

29 CLEMENTS LANE, LONDON, E.C.

And at Manchester

**WOOD PULP AGENTS**

Telegraphic Address:—  
"CHURCHILL, LONDON."

A.B.C. CODE  
5th Edition

**GEWERKSCHAFT SACHTLEBEN**

**Homburg-Niederrhein  
GERMANY**

**Largest Makers  
of all Qualities**

**Blanc Fixe**

**Three  
Varieties**

**Bright**

**Matt or Dull**

**Photographic**

**FOR SULPHATE AND SODA RECOVERY  
THE ZAREMBA PATENT EVAPORATOR**

**WILL GIVE YOU THE BEST RESULTS**



A 5000 gallon per hour Triple Effect installed for West Virginia Pulp and Paper Co., Tyrone, Pa.

*We furnish not the excellence of yesterday but the excellence of today.*

**Cylindrical Shells.      Horizontal Tubes easily removable**

**No Liquor Loss.      High Recovery.**

**Built for Long Life, Hard Service and No Worry to its Owner.**

**ZAREMBA COMPANY      -      Buffalo, N.Y.**

# THE SPLIT BASE PUMP

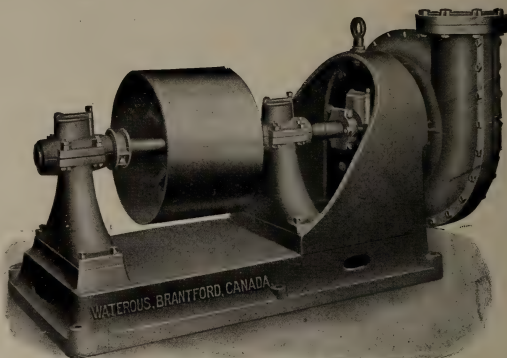

☐ *The split base is an entirely new construction incorporated in our latest design Centrifugal pump. It is of special benefit in pulp and paper mills where lack of space necessitates setting pump suction close to wall. By merely loosening a few bolts all working parts may be removed for overhauling without disturbing pump foundations.*

## OTHER WATEROUS FEATURES

☐ *Split bronze packing gland.—Reversible barrel—Extra long bearings—few parts—solid compact construction—every part readily accessible.*

**Built in Sizes with 4" to 14" discharge. For Belt,  
Engine or Motor Drive.**

☐ *We have installed these pumps in almost every Pulp and Paper Mill in Canada—over twenty in one mill. They are giving the very best of satisfaction.*

THE  
WATEROUS ENGINE WORKS CO.  
LIMITED  
BRANTFORD, CANADA.

**Geo. Christie Ltd.** - - - **Glasgow  
Scotland**

# FOURDRINIER MACHINE WIRES

Unequalled for Strength, Smoothness and Long Life

## CYLINDER COVERS

Canadian Agent:

**J. A. Taylor, 22 St. Francois Xavier St., Montreal**

# CANADIAN TALC FILLER

**GEO. H. GILLESPIE COMPANY**

**MADOC - - - ONTARIO**

*The only Manufacturers of Paper Filler in Canada.*

Our Filler is used in Canada, United States, England, Germany, Austria, Holland, Russia and Scandinavia.

# AMBURSEN HYDRAULIC CONSTRUCTION CO.,

OF CANADA, LIMITED

**405 Dorchester St. W. - Montreal.**

*Associated with the Ambursen Hydraulic Construction Co., of Boston, Mass.*



## Concrete Steel Dam

OF THE

**MISSISQUOI PULP CO.,**

**Sheldon, Springs, Vt;**

Mid-channel, height 49 feet.  
Total length 270 feet (only 180 feet shows in the picture, the remainder being concealed at the left.)

Dam specially designed to withstand heavy ice gorges.

Factors of safety, are calculated for a 12-foot flood.

**IF YOU HAVE A DAM TO BUILD, WRITE US NOW.**

Every Grade of Waste for  
Paper Making.

# R. HOUGH

LONDON, England.

Agent for Canada and U.S.,

**THE J. CHRISTIE CO.**

5 King St. West, TORONTO, Canada.

STEAM PUMPS  
CONDENSERS  
VACUUM PUMPS  
TRIPLEX POWER PUMPS  
CENTRIFUGAL PUMPS

**The Smart-Turner  
Machine Co., Limited**

HAMILTON

CANADA

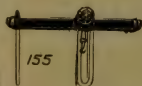
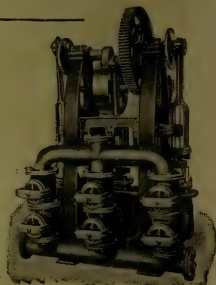

**CRANES AND ELECTRIC HOISTS**

Made in Canada

**NORTHERN CRANE WORKS LTD.**

WALKERVILLE

ONTARIO

Complete Overhead Track Systems



**HIGH  
TEST**

# BLEACHING POWDER

35/38%

(BRUNNER MOND & CO'S.)

**THE STRONGEST AND THEREFORE THE CHEAPEST**

**WINN & HOLLAND, Limited, MONTREAL**



# PULP AND PAPER MAGAZINE OF CANADA

VOL. 10 TORONTO, AUGUST, 1912 No. 8

## PRINCIPAL CONTENTS

Publishers' Announcement  
Casein in Canada  
The Three-Cow System  
Paper Yarn for Spinning  
Jack Pine and Memlock for Mechanical Pulp  
Sizing and Air-Drying of Writing Paper  
Improvements in Fourdrinier Machines  
Testing Retenability of Paper to Air  
Aluminium Sulphate in Sizing Sulphite Pulp

# THE JONASSEN PULP REFINER

For the Reclaiming of Ground  
Wood and Sulphite Screenings

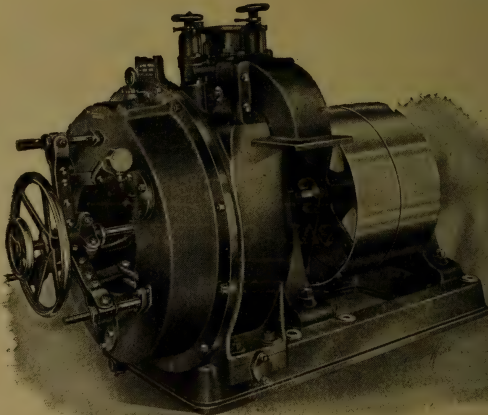

With this Refiner you save all your Ground Wood and Sulphite Tailings or Screenings, which now go to waste.

Capacity of Machine: From 8 to 10 tons of Screenings a day.

Power required to operate same: 20 horse power.

Write us for prices and further information.

Rice Barton and Fales  
Machine and Iron Co.

WORCESTER, MASSACHUSETTS, U.S.A.

*Increased Capacity and Efficiency—Decreased Handling Costs are Guaranteed Results where* **JEFFREY CONVEYERS**  
*have been installed in Pulp and Paper Mills.*

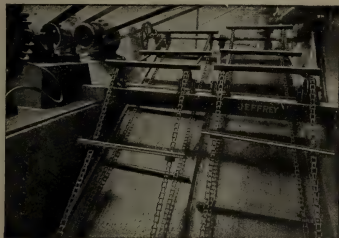

Wood Sliver Conveyers from Grinders in Paper Mill

They give maximum service at a minimum cost of upkeep.

There never was a conveying problem that could not be handled in the Jeffrey Way.

Experts, men who have made a life study of just such problems as yours, will go to your plant, spend weeks, if necessary, figuring and planning how Jeffrey Systems will cut your costs. We are at your service.

Ask us for copy of Catalog 57-E.

## JEFFREY MANUFACTURING COMPANY

*Canadian Main Office and Works, Montreal*

*Winnipeg Representatives - - N. J. Dinnen & Co.*

E. J. WELCH, *President and Managing Director*  
HENRY W. S. DOWNS, *Superintendent*

EMMONS CROCKER, *Vice-President*  
A. S. MORSE, *Secretary and Treasurer*

# SCREEN PLATES



The "Union" Bronze (best phosphorized cast metal) Plates for Sulphite Mills. The Standard Rolled Brass Plates. The "Union" Cast Metal Suction Plates.

We carry a large stock of blanks of the various sizes in both metals and can fill all orders promptly.

Old plates reclosed and recut by our process are practically as good as new and give better results than by any other process

## Union Screen Plate Co. of Canada, Limited

**FACTORY: LENNOXVILLE, QUEBEC.**

**OFFICES: Lennoxville, Quebec, and Fitchburg, Massachusetts, U. S. A.**

— THE BEST —  
**JORDON ENGINE**  
 IS BUILT BY THE

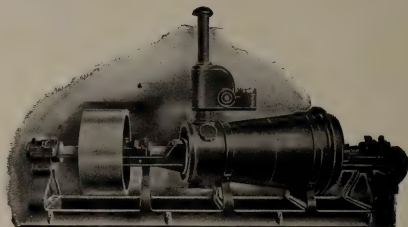

**APPLETON MACHINE CO.**

APPLETON, WIS.

SEND FOR PARTICULARS

**DODGE**

**Transmission** —\*

—\* **Machinery**

— High Grade Only —

Shafting, Hangers, Pulleys,  
 Friction Clutch Pulleys.

**DODGE MANUFACTURING CO.**

640 ST. PAUL ST.  
 HAYMARKET SQUARE **MONTREAL** LIMITED

Telegrams :  
"CALENDER, BURY"

Telephone :  
NUMBER 340

# Bentley & Jackson,

Limited

PAPER MAKERS'

.. ENGINEERS ..

BURY, - - ENGLAND

## *SPECIALITIES.*

MODERN HIGH SPEED NEWS PAPER  
MAKING MACHINES

SINGLE CYLINDER PAPER MAKING  
MACHINES

The NEW "*MARSHALL*" *PATENT REFINING ENGINE*, with separate adjustment to cones and discs,  
and our Patent Ball Thrust Bearing.

---

**APPLY FOR PRICES.**

---



# Bertrams Limited

SCIENNES

Edinburgh - - - Scotland

PAPER MILL MACHINERY

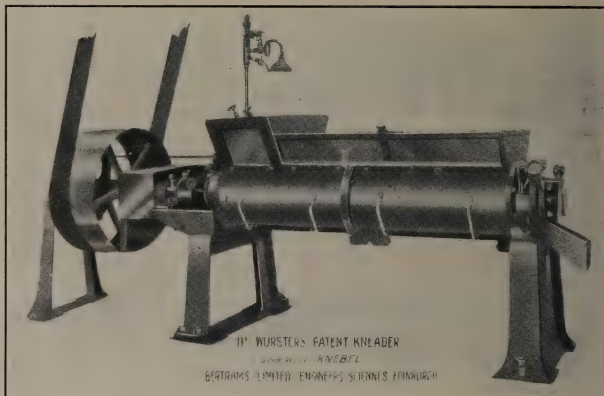

11' WURSTERS PATENT KNEADER  
MADE BY KNEBEL  
 BERTRAMS LIMITED ENGINEERS SCIENNES EDINBURGH

This Machine will be in operation at the North East corner Machinery Hall, at the Canadian National Exhibition, Toronto, Aug. 24th, September 7th.

Any mills desirous of having waste treated, are asked to consign sample to Chambers & Simpson, at Exhibition, which will be returned in a reduced state.

Full particulars from

**CHAMBERS & SIMPSON**

152 Bay St. - Toronto, Ont.

# New Centrifugal Screen

WITH HORIZONTAL SHAFT

PATENTED IN ALL PRINCIPAL COUNTRIES

**Smallest Power  
Highest Output**

**Direct Belt Drive  
Noiseless Working**

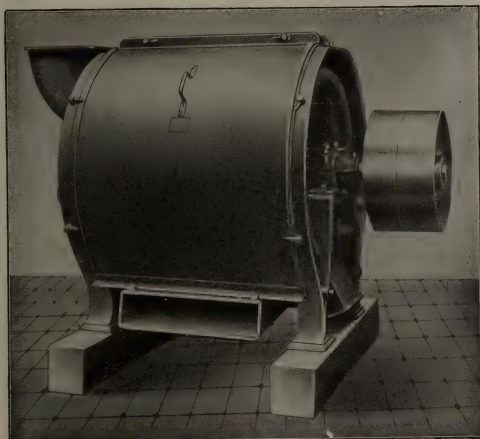

Equally well adapted for GROUND WOOD and SULPHITE

*I have now sold over 800 of these Screens*

FURTHER DETAILS, PROSPECTUS AND PRICES ON APPLICATION

**Complete Machinery for Wood Pulp, Paper and  
Sulphite Mills**

---

---

## J. M. VOITH

ENGINEERING WORKS AND FOUNDRIES

HEIDENHEIM ON BRENZ, WURTEMBERG, GERMANY

Branch Office for Canada and U.S.A., 1008 Fifth Ave. Bldg., New York

Representative: H. F. STORRER, C.E.

J. MARX &amp; CO.

--

LONDON, E. C., ENGLAND

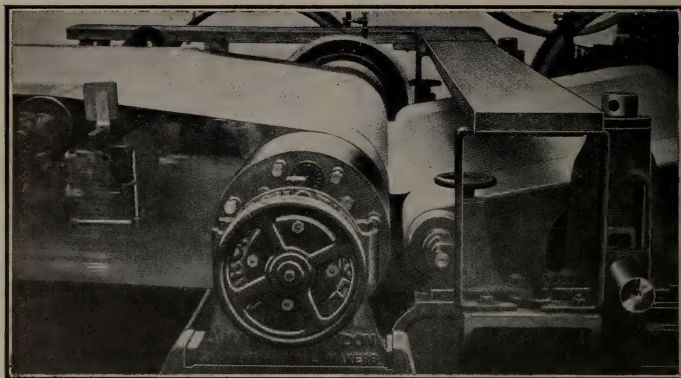

MARGALT SUCTION ROLL AT WORK

SPECIALTIES BASALT LAVA STONE BEATER ROLLS, DOUBLE BEATERS, STONE WET PRESS ROLLS, BASALT LAVA PULP REFINERS FOR SCREENINGS

Canadian  
Representative

Judson A. DeCew

Canadian Express  
Building

Montreal

*The*

## Harmon Incline Screening System

Will give greatest capacity.

Will give cleaner stock.

Will save power.

Will save labor.

Does not require use of Rakers.

Write us for full descriptive Catalogue and testimonials from the best mills in the country.

## HARMON MACHINE COMPANY

WATERTOWN, N. Y., U. S. A.

OTTO WANDEL  
President

HERBERT H. MILLER  
Treasurer

# Wandel Screen Manufacturing Co.

WALPOLE, MASS., U.S.A.

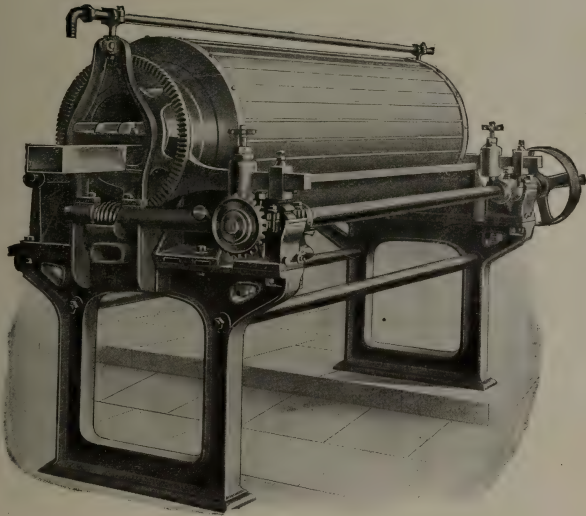

MANUFACTURERS OF THE

Quick Delivery.

Write for Catalogue  
and list of users.

We have no author-  
ized Agents in  
Canada.

# WANDEL ROTARY SCREEN

Over 200 Wandel  
Screens have  
been built and sold  
by us in the States  
within two years.

## SUPERIOR CONSTRUCTION

---

**THE SANDY HILL IRON AND BRASS WORKS, HUDSON FALLS, N.Y.**

---

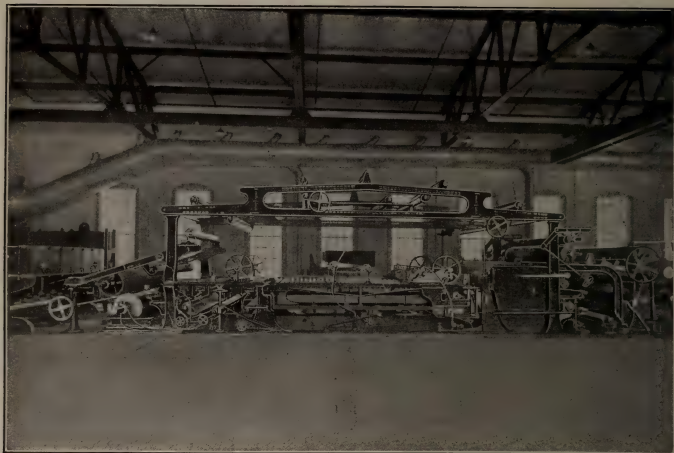

130" HARPER FOURDRINIER PAPER MACHINE

---

## A GOOD JORDAN ENGINE

BUILT IN 3 SIZES.

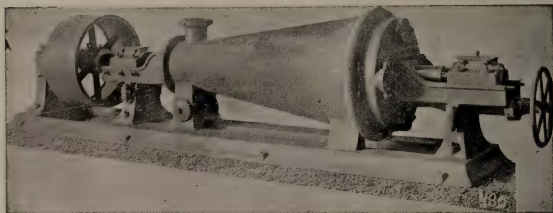

## THE BLACK-CLAWSON CO.

HAMILTON, OHIO, U.S.A

Builders of **PAPER MAKING MACHINES** and machinery for Paper and Pulp Mills. Our machines are completely erected in shop on cast iron levelling plates and carefully inspected before shipment.

*Write for Catalogue.*



# The "WESTBYE" SCREEN

*Its Novel Features are of Importance to You*

Built for Belt or Motor Drive

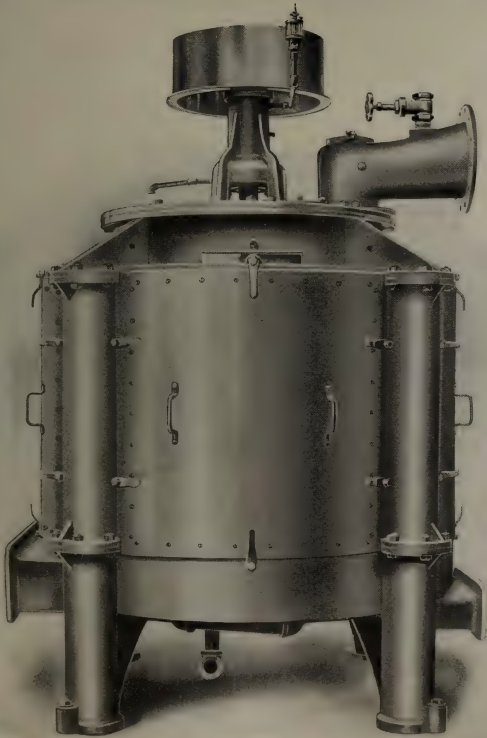

Investigate and learn something NEW in the screen line

*For Details and Prices  
apply to*

**P. P. WESTBYE**  
**PETERBOROUGH,**  
**CANADA**



## GARLAND PULP LOG Storage and Conveying Systems

Inventors of the CABLE CONVEYER

*We have equipped 50 of the best American PULP and  
PAPER MILLS with CONVEYERS, LOG CUT OFF  
SAWS, SLASHERS, SPLITTERS, BAND MILLS and  
SPECIAL MACHINES*

*Send us your plans or ask for  
Representative to call on you*

---



---

### THE M. GARLAND COMPANY

Manufacturers of CONVEYING, SAW MILL  
and WOOD DESTRUCTIVE MACHINERY

BAY CITY - - - MICHIGAN, U.S.A.

# Have You Heard the Facts About The Beloit Machines?

---

---

One Fourdrinier built for 500 feet has run 615 feet, and averages 550 feet and makes 72,000 lbs. of print in 23 hours, 110 inch trim.

Another, built for 350 feet, for manillas, is running 490 feet every day on print.

Two others, built for 250 feet on book, are now speeded up to 340 feet on book.

A cylinder machine built for 40 tons of strawboard has made 89 tons in 23 hours, and averages 76 tons per day, dryers are 116 inch face.

---

---

## Beloit Iron Works

BELOIT, WIS., U.S.A.

# DILLON MACHINE CO

BUILDERS OF

## PAPER MILL MACHINERY

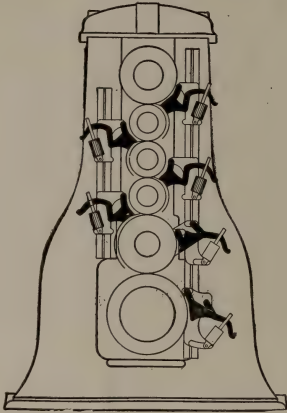

- Beating Engines
- Washing Engines
- Jordan's Three Sizes—  
Single, Double & Triple  
Stuff Pumps, with  
Dillon Patent Valve  
Seating
- Brannan Patent Paper  
Folders
- Horizontal and Vertical  
Stuff Chests
- Single and Double Paper  
Cutters
- Backstands
- Plates, Knives and Bars

DILLON  
 PATENT  
 DOCTORS  
 AND FEEDS  
 MADE IN  
 CANADA  
 BY THE  
 SHERBROOKE  
 IRON WORKS,  
 SHERBROOKE, P.Q.

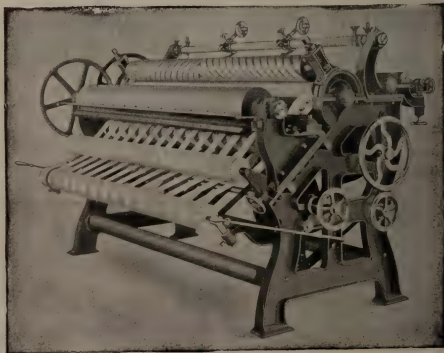

# LAWRENCE, MASS., U.S.A.

---

---

# The MOORE & WHITE CO.

PHILADELPHIA, PENN., U.S.A.



SEND FOR BULLETIN



Very severe tests have been made of this winder, but all of them have exceeded expectations. The photograph shows the winder attached to our standard slitter part which takes up less room than any other slitter and has several very good features. The winder can be used as a rewinder by attaching a back stand to carry the roll which is to be re-wound.

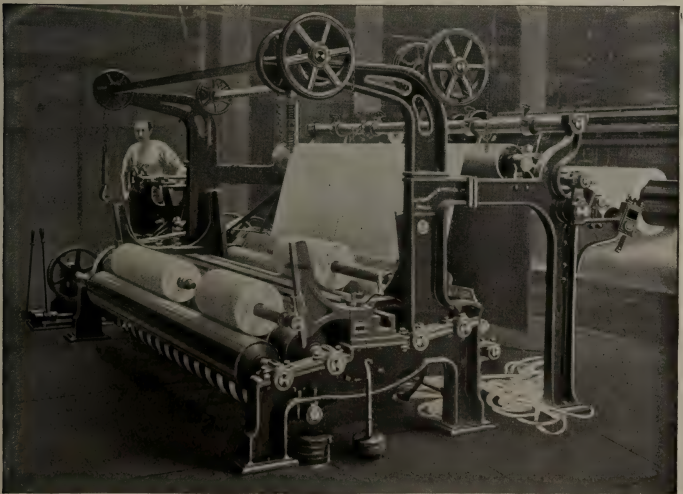

"M & W" Patented Four Drum Winder in operation

**SATURATING, COATING AND WATERPROOFING  
MACHINERY**

**SPEED CHANGES**

**FRICITION CLUTCHES**

---

---



# HOLYOKE MACHINE COMPANY

## HOLYOKE, MASS., U.S.A.

MANUFACTURERS OF

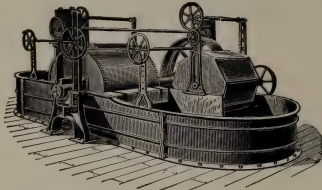

Washing and Beating Engines with  
Patent Double Hoist and Tubs of either  
wood or iron.

Hydraulic Pumps and Presses.

Rag Cutters and Rag Dusters.

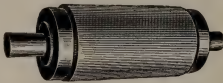

Cotton and Paper Rolls with Patent Fastenings.

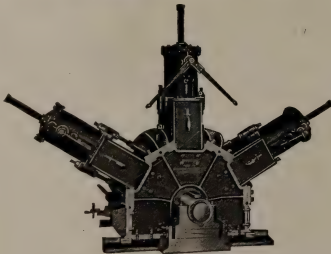

Patent Improved Wood Pulp Grinder.

Elevators, Rotary Fire Pumps and  
Friction Gearing.

Gears Accurately Spaced and Planed.

Shafting, Pulleys and Mill Work.

Machinery for Wood Pulp and  
Paper Mills.

Vertical and Horizontal Water  
Wheels with Flumes and  
all connections.

Wood Barkers, Wood Chippers  
and Wet Machines.

## Newest Designs

AND

## Highest Efficiency

Calenders. All kinds of Super  
Calenders, Friction Calenders  
and Platers.

Chilled Iron Rolls.

Special Machinery

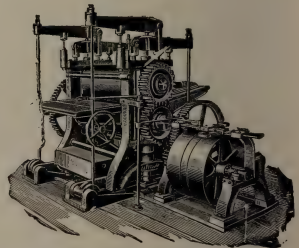

Description and Estimates Furnished; also Gear List  
and Catalogs sent on application.

# Pulp Mill Machinery

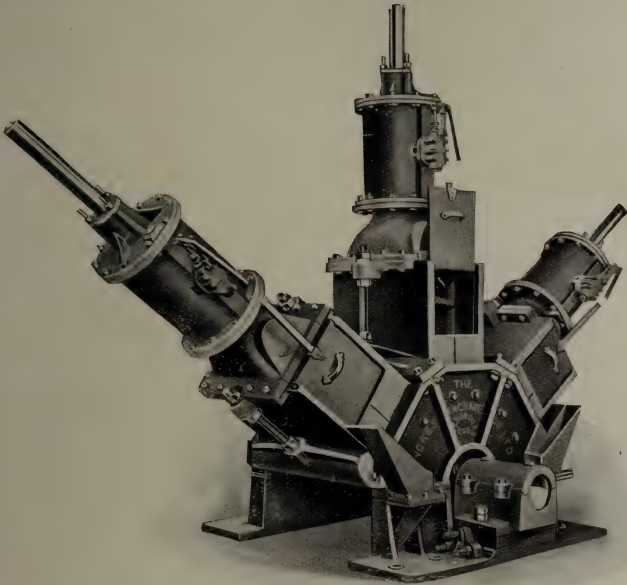

Our Grinders combine the latest and best features in Wood Pulp Grinder construction and have many recent improvements.

We also manufacture Wet Machines, Screens, Presses, Barkers, Complete Wood Room Equipment and Turbine Water Wheels.

LET US QUOTE ON YOUR REQUIREMENTS.

## The Jenckes Machine Co., Limited

General Offices: SHERBROOKE, QUE.

Factories: Sherbrooke, Que., St. Catharines, Ont.

Sales Offices: SHERBROOKE, MONTREAL, ST. CATHARINES, COBALT  
SOUTH PORCUPINE, VANCOUVER, NELSON, B. C.

# James Bertram & Son,

LIMITED.

LEITH WALK - EDINBURGH

---

## “LEITH WALK”

PATENT HALF DRUM STRAINER

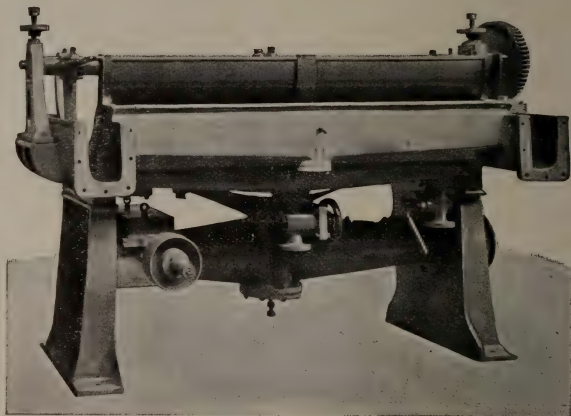

### *ADVANTAGES :*

Enclosed Self Lubricating Driving Gear  
Stroke can be altered whilst Strainer is at work  
Plates can be cleaned in a few minutes without removal  
Noise'ess in action, with small cost in upkeep  
Great capacity with upward flow of Pulp

---

Telegrams : “Bertram, Leith”

# PNEUMATIC

## *Save-Alls, Pulp Thickeners and Filters*

Remember that we make Special Pneumatic Machinery,  
not only for saving waste from white water but for  
thickening pulp and

*for filtering river water*

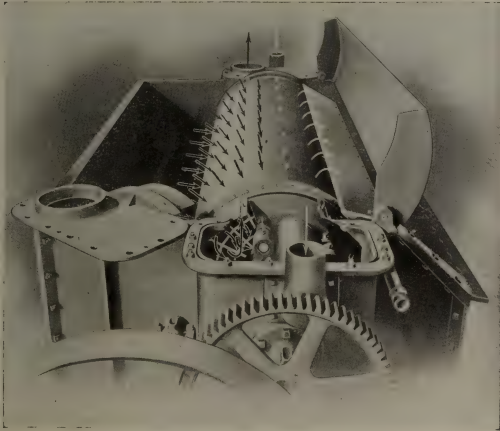

Pneumatic Action of the Save-All

The same pneumatic principle which has made our Pneumatic Save-alls and Pulp thickeners so successful has proved wonderfully effective in our Pneumatic Filter for river water. In this machine we employ an exceedingly fine cylinder-mold facing, through which several million gallons of water per 24 hours can be filtered clean. The clean filtering is due to the minute "mesh" of the covering and the continuous cleansing with air-blast and water-jet; the enormous capacity is due to the pneumatic action; the long life of this Filter is due to the absence of all mechanical wear upon the cylinder.

This machine is filtering clean even in cases where the river is exceptionally dirty because of saw mills located upstream.

*Send for particulars*

---



---

**Sherbrooke Machinery Company**  
LIMITED

SHERBROOKE

QUEBEC

**RENOLD PATENT SILENT CHAINS**

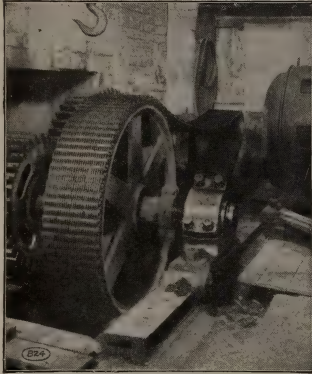

(Drive Stationary)

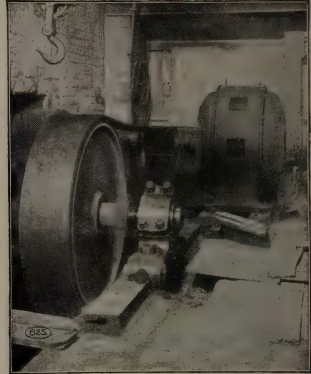

(Chain Speed 1,180 f. p. m.)

150 h.p. Line Shaft Drive

**NOT AFFECTED BY HEAT, VAPOR OR MOISTURE**

We have installed, and in some cases completely equipped, the largest and foremost Pulp and Paper Mills in Canada with the Renold Chains

**JONES & GLASSCO**

Registered

**SOLE CANADIAN AGENTS  
MONTREAL**

**Lawrence Machine Co.**

LAWRENCE

MASS.

— MANUFACTURERS OF —

**Lawrence Centrifugal Pumps**

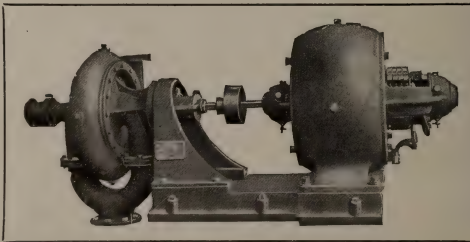

LET US FIGURE ON YOUR REQUIREMENTS



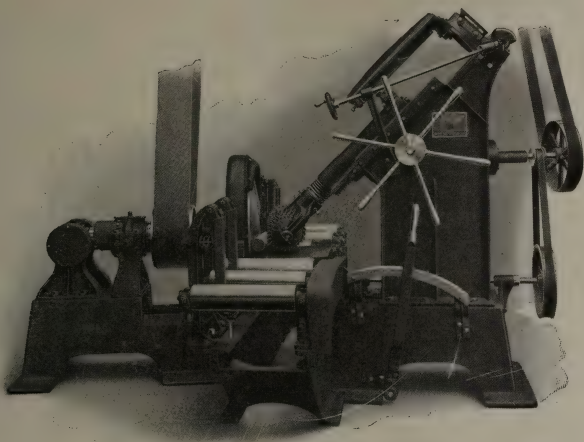

## Are You Aware of the Fact?

That the Robert & Libert Green Bay  
Barker covers every pulp producing  
country in the world.

### Green Bay Barker Co.

GREEN BAY, WIS.

KUNSANKOSHI, FINLAND.



Interior of the  
Machine  
Room of  
Messrs. Ed-  
ward Lloyd,  
Ltd.

Sittingbourne,  
England,  
containing the  
last two  
machines  
supplied to  
this Company  
by Chas.  
Walmsley &  
Co., Ltd.



These "Walmsley" Fast News Machines are 175 inches wide, and are making paper at over 600 feet per minute, with an output of 500 tons news print weekly. The machines are equipped with the Lloyd and Hutchison Patent Drive. This patent device is controlled by Walmsley & Co., Ltd., and dispenses entirely with Friction Clutches and Gear Wheels.

# Charles Walmsley & Co. Ltd.

PAPER MAKERS' ENGINEERS

Head Offices,  
ATLAS WORKS  
Branch,  
WOOD STREET

BURY - England

Codes, WESTERN UNION, A.B.C. 5TH EDITION,  
MCNEILL'S 1908

Telegrams, "PUMPS, BURY." Telephone, BURY 499

## SPECIALTIES—

Complete Paper Mill Plants  
Variable Speed Enclosed Steam Engines  
Cone Beaters for News Stock  
Slitting and Re-Reeling Machines  
Beating and Refining Engines  
Super Calenders  
Buffing Machines, etc., etc.

## FOREIGN REPRESENTATIVES

Norway, Sweden and Finland :  
N. A. EIE - Christiania  
Austria, Hungary :  
F. SCHOFFEL, Engineer, Vienne  
CANADA :  
C. H. JOHNSON & SONS  
LIMITED  
ST. HENRY, MONTREAL

# Wilson-Paterson Co'y



127 BOARD OF TRADE BLDG., MONTREAL.

Agents for the United Alkali Co. of England

## **OFFER TO THE TRADE:**

Caustic Soda 60° to 78° Soda Ash, Caustic Potash, Sal Soda, Silicate of Soda, China Clay, Rosin size and a full line of Rosins, direct shipment from the south.

**Contracts made for regular supplies.**

# PARSONS TRADING COMPANY

*Exporters of Paper to all Parts of the World*

WHITEHALL BLDG., 17 BATTERY PLACE, NEW YORK

BRANCH OFFICES AT

LONDON

SYDNEY

MELBOURNE

WELLINGTON

CAPE TOWN

BOMBAY

HAVANA

MEXICO, D.F.

BUENOS AIRES

**CORRESPONDENCE WITH MILLS SOLICITED**

# THE CARTHAGE CHIPPER

WILL INCREASE YOUR CHIPS. WILL  
DECREASE YOUR SAWDUST. By virtue  
of its Design and its Patent Feed Spout it takes a  
MINIMUM AMOUNT OF POWER.

---

Ask Anglo- Newfoundland Development Co.  
Ask Laurentide Pulp and Paper Company.  
Ask The Riordon Paper Company, Limited.

---

OR WRITE

**CARTHAGE MACHINE CO.**  
**CARTHAGE, N.Y.**

# Pulp and Paper Magazine of Canada

*A Magazine devoted to the interests of Canadian Pulp  
and Paper Manufacturers and the Paper Trade.*

SUBSCRIPTION PRICE; \$2.00 a year. Single Copies, 20 cents.

OFFICE OF PUBLICATION : 226-7 Confederation Life Building, Toronto, Canada  
MONTREAL OFFICE : 34.B. Board of Trade Building

## ANNOUNCEMENT

We beg to announce that The Pulp and Paper Magazine of Canada, published since its inauguration by Biggar-Wilson, Ltd., has been sold to a new organization, known as the Industrial and Educational Press, Ltd., Toronto and Montreal.

Under the new management, it will be greatly enlarged and improved, the first step decided on being to publish the Magazine twice a month. The circulation will also be materially increased.

By a system of correspondents sending in regular reports from every pulp and paper centre in the Dominion, readers will be kept in close touch with every phase of the industry; while up-to-date articles by the best and most practical writers will render it invaluable to mill owners and employees alike, as well as to those interested in all branches of the paper trade.

No argument is needed to-day to prove that Canada, with its extraordinary wealth in raw material and in water powers, is rapidly forging ahead as one of the very greatest pulp and paper manufacturing countries in the world. There is no reason why the organ of this important industry should not be in keeping, and this is what the publishers intend to give; a pulp and paper journal equal to the best in the world.

The hearty co-operation of all our readers is invited, as much in their interest as in our own. Any suggestions with which they may see fit to favor us will be greatly appreciated by the publishers at the above address.



## Reciprocity Abolished

The United States Senate has once more made a *volte de face* on Canadian reciprocity and the duties on Canadian pulp and paper. By a vote of 37 to 18 it passed the House Excise Tax bill which includes a provision for the repeal of the reciprocity agreement with Canada and the substitution of a duty of \$2 per ton on newsprint. The clause regarding the duties on pulp and paper reads as follows:

"That from and after the passage of this act the duty on chemical wood pulp shall be one-twelfth of one cent per pound, dry weight, if unbleached, and one-eighth of one cent per pound if bleached; and the duty on printing paper as described in paragraph 409 of the act approved August 5, 1909 (the Payne-Aldrich tariff law), shall be one-tenth of one cent per pound if valued at not above three cents per pound, two-

tenths of one cent per pound if valued above three cents and not above five cents per pound, and 7-12 per cent. *ad valorem* if valued above five cents per pound."

Several senators argued in favor of retaining the provisions of the act respecting pulp and paper, but they were defeated.

President Taft is understood to hold now the position that, while personally still in favor of the principle of reciprocity, he would agree to take it off the statutes in view of Canada's refusal to participate.

The passage of the above bill, if ratified, will, we suppose automatically settle the differences of opinion existing in connection with the free entry into the United States of foreign pulp and paper under the Favored Nations Act.

---

## Casein in Canada

A piece of news which should be suggestive to Canadians is reported from Sweden. It is not long since all the casein used in that country was imported from America. Then a factory for making casein at home was started, and since that time a number of others have been established. The result is that at the present time not only do most of the Swedish paper mills use domestic casein, but considerable quantities are being exported to other countries. It would certainly appear reasonable to think that what Sweden has done Canada can do likewise.

As is probably known to our readers, casein is the chief constituent of skim milk, or of the solid portion of milk after the butter has been drawn out. Chemically it is the result of the action of acetic acid on

certain organic contents of milk, and resembles gelatine in many respects. It has the property of submitting to double decomposition which is taken into account in paper finishing processes by rendering insoluble those otherwise soluble salts which have been previously applied. An example is the whitening and coating of fabrics impregnated with barium salts. Its good coloring qualities also make it of value.

This country with its highly developed dairying industry should present good openings for the manufacture of casein. Particularly should this be the case in view of the conversion of factories in recent years from cheese to butter making. One obstacle which will occur to those having the agricultural interests of the country at heart is that skim milk is an invaluable food for grow-

ing stock and thus assists materially in keeping up the fertility of the land. While this is a pertinent objection, however, there is no doubt that in the aggregate, vast quantities of this commodity are at present wasted every year and that from this there could be manufactured a large quantity of casein.

Another possible obstacle to any considerable manufacture of casein as a by-product of Canadian creameries is the increasing use by farmers of individual separators. In former years their cream was separated in bulk at the factory. As each farmer's method of separating is more or less different, this militates against uniformity of product. However, these objections are not immovable. Indeed, we understand that the idea of manufacturing casein in Canada is not entirely new, as the project was under consideration a

year or two ago, and some Ontario agricultural authorities were looking into the matter.

Canadian paper manufacturers use casein to the extent of probably 300 tons annually. This is mainly imported from or by way of the United States, the customs authorities here classing it as glue and charging an import duty of 27½ per cent. In the latter country the market is controlled by the Casein Company of America, who hold a certain number of patents on processes, etc. They are quite unable, however, to supply the demand by domestic production, and large quantities come from the Argentine Republic, which no doubt is the origin of most of that used in Canada. The question of manufacturing it on a large scale in this country is one which may well be looked into.

---

### The Three Tour System

In Kalamazoo, one of the most important paper manufacturing centres on the continent, a lamentable situation prevails, a number of the mills having been closed down for some weeks. The men, though we believe, their wages had been only recently increased, struck work for shorter hours, and rather than have trouble of this sort on their hands, the employers instituted a lock-out.

As is frequently the case, there seems to be warrant for the belief that a certain amount of blame attaches to both sides, or rather a lack of understanding on each side of the other's position. The root of the trouble was that the men wanted the three-tour system of working. Now, theoretically perhaps but little can be said against that arrangement of hours. In fact more and more of the larger mills in America are adopting it, and in the end it will doubtless prove satisfactory to all. But there are practical considerations which sometimes render such a radical

change out of the question without a considerable amount of preparation.

Whether these particular mills were backward in the making of such preparation and in the recognition of its necessity we do not know. It assuredly, however, would not have hurt the hands to have waited a while until proper arrangements could have been made. In the meantime they themselves are the chief sufferers, for the majority have no regular means of subsistence at all. While one has to sympathize with the natural desire of the paper employees to improve the conditions of their life, it must be confessed that under the influence of some of their leaders they show a distinctly foolish tendency to bite off their nose to spite their face. The whole episode is still one other evidence of the constant increase going on in the operating expenses of paper production.

## Paper Yarn for Clothing

The constantly increasing cost of living is drawing keen attention to the possibilities of using paper, instead of wool, cotton and other yarns, for clothing purposes. Canada, with its extraordinary wealth of paper-making materials, in the shape of pine and spruce fibre, should lose no time in getting into the race for the manufacture of paper clothes which we believe will undoubtedly develop during the next few years. Textile goods made of paper are no new story, as already a large number of goods of this description are on the market, such as stair mattings, mats, carpets, toweling, webbing, furniture coverings, and so forth. In combination with wool, paper yarns have been made into tweeds and worsteds, and with cotton into overalls for workmen's use. The materials which are most likely to be displaced by the new fibre are jute, cotton, hemp and flax, in which the market is being continuously upset by bad crops and the increasing demand.

In making the yarn, the paper, in rolls of about 19 inches wide, is placed in a cutting machine which cuts the entire width in one operation, the widths of the strips being from one-sixth inch upwards, according to requirements. The strips are next rolled upon bobbins and are taken to the spinning frame, which has one spindle for each bobbin, the paper strips being damped by a roller before spinning, otherwise they could not be spun. For the strongest yarn Swedish kraft-paper has proved to be the best material, but pure sulphite paper, free from mechanical pulp, gives a fairly strong, useful yarn, while for fine yarns tissue paper is the only one admissible.

The spinning itself is very simple. There is no fibrous dust flying about, for the surface of the paper is smooth and non-friable—an important feature in spinning of all kinds. All shades of colors are readily dyed,

either on the paper before spinning or on the yarn afterwards, and the yarns can be easily impregnated with waterproofing substances, or with bodies conferring a high lustre. Some fabrics containing from 25 per cent. of paper yarn upwards are very difficult to detect from cloths made from cotton, jute, or hemp, and where a smooth yarn, free from projecting hairs is required, these paper products are very suitable. As regards fireproof qualities, paper is a ready absorbent of such chemicals as sodium phosphate, tungstate of soda, etc. The addition of these substances makes no difference to the appearance of the yarn, and if necessary they could be introduced when the paper is damped before spinning.

In Manchester a company is engaged in making a fabric called silvalin. Some grades are said to be good enough to be used for trousering, while others give a poplin effect. Another experimental weave is a twill venetian coating, the warp showing on the face being a crossbred wool and the weft on the back being pure paper. This yarn is said to prove sometimes brittle, but this is believed to be due to defects in the process which will be improved in time.

A large firm of English paper-makers is said to be working in the hope of producing paper entirely suitable for the making of clothes which can be sewn and will hold buttons. Paper shirts have already been produced at 12 cents each and handkerchiefs at 2 cents.

The manufacture and marketing of paper clothing at such a price means a great reduction in a family's laundry bill. In many respects paper yarn fills the requirements admirably. It is cheap, it resists the effect of water, and it is resistant to heat and cold. Doubtless the Canadian paper industry is fully employed at the present time in filling orders for ordinary goods. But there would

certainly appear to be an opening for some live house to start, experimentally at any rate, in the enterprise of adapting paper to numerous commercial uses far beyond its usual scope.

---

#### EDITORIAL COMMENT.

Mr. Jas. Lawler, of Ottawa, Secretary of the Canadian Forestry Association, has experienced a busy time making preparations for the convention to take place in Victoria, B.C., on September 4th, 5th and 6th. Great personal interest is being taken in the gathering by Sir Richard McBride, the Premier, and by other Governmental authorities in the Pacific Province, besides which John Hendry, who is president of the Association, is a resident of Victoria. A trip to British Columbia will be an interesting experience to the large numbers of lumber and pulp men who have already expressed their intention to be present. The railroads have made very cheap rates. The convention will be of peculiar interest through being held in a part of the Dominion so rich in wood resources, but all parts of the country will be represented. Recent disastrous fires in Ontario and Quebec show only too well how necessary preventive measures are, and what a wide scope still exists for forestry deliberations and legislation.

\* \* \*

According to the ideas of Prof. G. Andersen, of the University College of Commerce, Stockholm, and Dr. A. Holmgren, chief forester of Sweden, Scandinavia has not much to learn from Canada either in forestry or in pulp and paper matters. They were much impressed by the magnitude and modern equipment of the Booth & Eddy mills, but in regard to forestry Prof. Andersen thinks Canada to-day is in the same position that Sweden was fifteen years ago. At that time and for years previous the question of forest fires had been one of prime importance in Scandinavia. The system of

fire guards, lookout towers and intercommunication between guards by means of telephone, only now being instituted on the Canadian reserves, had been established for years in Sweden. "There is no danger of our Swedish supply of pulp wood giving out," he stated. "By means of reforestation methods which have been adopted it will last forever. While you in Canada are working on the first cut of your timber and pulp wood, we are now using the second growth. Our pulp and paper industry is the greatest of any nation in the world, and will continue to be."

---

#### KENOGAMI PAPER MILLS.

The buildings for the large new pulp and paper making plant which Price Bros. & Co., Ltd., are erecting near Jonquiere in Chicoutimi County, Quebec, are now almost completed, and it is expected that paper will be made next month. The capacity will be 150 tons of paper daily. The company owns 25,000 h.p., part of which of course is already developed. Its pulpwood limits are among the largest in Canada. A new town is in course of formation, already numbering a population of nearly 4,000, which will doubtless be greatly increased when the new mills are in full operation.

Mr. William D. Gregor has been appointed superintendent of the new mill. He had been for the past few years acting in that capacity for the Oxford Paper Co., at Rumford, Me.

---

A recent decision of U. S. Treasury Department declares that British Columbia pulp and paper from certain lands from which restrictions have been removed, will be admitted free of duty under that clause of the Reciprocity Act. Certain leases controlled by Powell River Company, west of Cascade Mountains, are affected. The order is expected to lead to increase in importations by British Columbia pulp and paper to the Pacific States. Whether this decision will hold in view of the action of the Senate in repealing the entire Reciprocity agreement is a question.



## Jack Pine and Hemlock for Mechanical Pulp\*

### Need of a Substitute for Spruce Pulpwood.

Few well-established industries have expanded as rapidly as has the pulp and paper industry. In less than a decade the amount of raw material used annually has more than doubled. During 1900 there were consumed in the United States 1,986,310 cords of pulpwood. The ground-wood process

58½ per cent. The domestic spruce consumption for this purpose increased 35 per cent. and the consumption of miscellaneous woods 80.5 per cent. But the largest increase was in the use of imported spruce, the consumption of which increased 162 per cent.

The price of spruce has increased at a

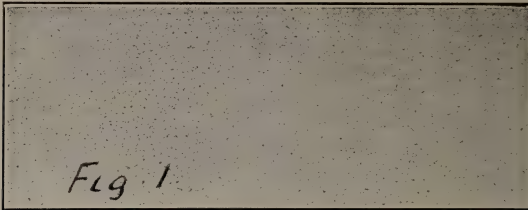

used 598,229 cords of domestic spruce, 120,820 cords of imported spruce, and 67,791 cords of other woods, such as hemlock, jack pine, poplar and balsam, or a total of 786,840 cords. During 1909 the amount of wood used in all processes was 4,001,607 cords, the ground-wood process using a total of 1,246,121 cords, which consisted of 806,282 cords of domestic spruce, 317,289 cords of imported spruce, and 122,550 cords of other miscellaneous woods.

Thus the increase in the total amount of pulpwood used during this period was 101 per cent., while the amount of pulpwood of

very rapid rate. In 1900 the average cost of spruce used in all processes in the United States was \$4.83 per cord for domestic spruce and \$6.50 for imported, while in 1909 the average price of domestic spruce was \$9.32 and of imported \$11.34 per cord.

This increase has been reflected in the cost of ground-wood pulp. The manufacturing cost of pulp, as determined by the Tariff Board, increased from \$10.84 per ton in 1900 to \$16.58 in 1909, 93 per cent. of this increase being accounted for by the greater cost of the wood used. Manifestly, therefore, it is almost essential, if the

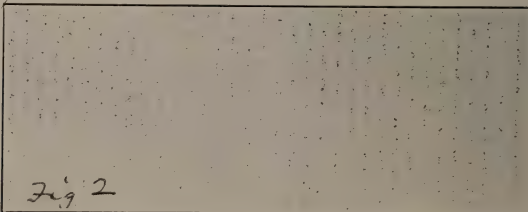

all kinds used for ground wood increased

ground-wood industry is to continue, that substitutes be found for spruce pulp, especially in the manufacture of news, wrapping, and other of the cheaper grades of paper. To determine whether there are not other domestic species which will produce a commercial grade of ground wood suitable

\* Abstract of a Report on Experiments with Jack Pine and Hemlock for Mechanical Pulp, by J. H. Thickens, Chem. Eng. in Forest Products. Issued by Forest Service of U. S. Dept. of Agriculture.



for the purpose, etc., the Forest Service, in co-operation with the American Pulp and Paper Association, began an extensive series of tests on several of the woods which occur in large quantities in the United States, particularly in the Lake States. The woods which have been tried up to the present are hemlock and jack pine, together with a small amount of spruce, for the purpose of comparison.

The experiments were conducted at Wausau, Wis., under the general supervision of the director and assistant director of the Forest Products Laboratory, and an advisory committee of the American Pulp and Paper Association.

#### Results of Experiments.

Not only have very promising sheets of pulp been obtained from both the hemlock and jack pine, but paper has been made from them on commercial machines, operat-

only slightly off color, though they are the result in each case of but a single attempt to secure the standard degree of whiteness.

Since the experiments on hemlock have brought out a number of points in favor of the grinding of that wood, two paper-mill companies have signified their intention of using it in their cheaper grades of paper. One of these mills has already begun to do so, and is well satisfied with the pulp obtained.

#### Why Jack Pine and Hemlock Have Not Been Used.

There is much doubt as to exactly why the pulp industry has neglected to use hemlock and jack pine for the cheaper grades of paper. It seems to be the general impression that hemlock grinds so fine and short that there is a great loss in conversion. It has been said that the yield ob-

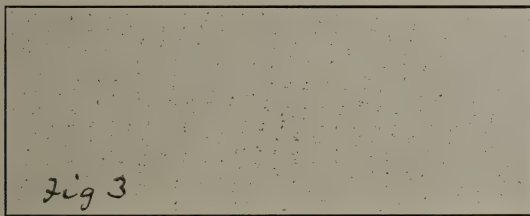

ing at high speed, and under all other conditions of actual commercial practice, which has the strength, finish, and appearance of standard news paper. The production per grinder, the horsepower consumption per ton, and the yield per cord approximate the averages which obtain in the grinding of spruce. Again, pulps composed of mixtures of hemlock, spruce, and jack pine in different proportions have been obtained, which compare very favorably with the ordinary spruce ground wood.

Hemlock ground wood has a decided reddish tinge, though this is not very noticeable, even in an all-hemlock sheet of news paper. Jack pine pulp is also slightly off in color, but is not nearly as dark as hemlock pulp. Careful study by experts should make it possible to bring the color of the paper produced from these pulps more nearly to the usual white. As it is, the sheets of news paper which have been secured are

tained is in many instances only three-fifths of that from an equal amount of spruce. This loss in grinding hemlock has not been in evidence during the tests.

The pitch in jack pine is undoubtedly responsible for the lack of attention paid to that wood. This, however, can be removed by steaming or soaking, and such treatments will be taken up in future experiments.

In all the experiments the yields secured from the different woods were in direct proportion to their bone-dry weight per cubic foot. It is, therefore, to be expected that the yields from jack pine and hemlock will be less per unit of volume than those from spruce, since the two first woods are considerably lighter in weight. On the basis of weight, however, there appears to be relatively little more loss in converting hemlock or jack pine into pulp than in converting spruce.

The fibre obtained from the ground hemlock and jack pine has been considered unsatisfactory on account of its shortness. Yet it has been found long enough for use in cheap papers.

One who is accustomed to handling spruce ground wood will not be favorably impressed with the appearance of either hemlock or jack pine pulp. This is particularly true of the hemlock sheet. Both pulps are somewhat softer in texture than spruce, and, altogether, are not as pleasing in appearance as the present commercial product.

Another point which may account for the lack of attention paid to hemlock and jack pine is the care which must be exercised in grinding them. It is possible to obtain a grade of pulp from spruce which is suitable for most purposes without using a great deal of care in the preparation of the

were the variables which received most attention. No especial attention was given to economic considerations.

Tests were made with pressures of from 20 to 75 pounds per square inch on the cylinder, corresponding to from 8.2 to 30.8 pounds per square inch of pocket area. The speed of rotation of the stone was varied from 84 to 225 revolutions per minute, corresponding to a range in peripheral speed of from 1,173 to 3,150 feet per minute.

In studying the effect of the surface condition of the stone it was necessary to utilize burrs of many different types and designs. These ranged in fineness of cut from 12 to the inch to 3 to the inch. The style of cut differed also, spiral cut, diamond points, and straight cut being employed. The power applied to the grinder ranged from 87.3 to 520 horsepower, while the rate of

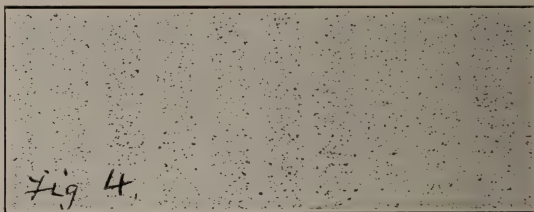

surface of the pulp stones. In the grinding of jack pine and hemlock, especially hemlock, on the other hand, great care must be exercised in bringing the stone to the correct degree of sharpness, since these woods will grind to powder if the surface is as sharp as the one ordinarily employed in grinding spruce.

Yet notwithstanding certain shortcomings the fact remains that it is possible to obtain hemlock and jack pine pulps commercially which are suitable for the cheaper grades of paper.

#### Qualitative and Quantitative Tests.

In order to cover the field in a reasonable length of time, short tests ranging up to two hours in length were run. In these tests no attempt was made to cover every point, the object being to touch only such as were thought to have a marked effect on the quality of the product. The surface of the stone, the pressure on the grinder cylinder, and the peripheral speed of the stone

production of bone-dry pulp varied from 1 ton to 7.3 tons in 24 hours. It should be understood that neither the two minimum nor the two maximum values were necessarily obtained from the same test. When the power applied to the grinder was 87.3 horsepower, for instance, it does not necessarily follow that the production was 1 ton per day. The horsepower consumption per ton under the given conditions was found to vary from 68.3 to 196 in 24 hours.

#### Commercial Tests.

Treatment of the Wood Before Grinding.

All of the wood used in the tests was cut either in Wisconsin or Michigan and was representative of the species. In some cases the wood was secured directly from the forest, while in others it was shipped to the laboratory from near-by mills. Upon arrival at the laboratory the logs were closely piled on skids. An attempt was made to keep the material green by painting the ends with paraffin, but this proved unsatis-

factory, because the paraffin peeled off. The wood tested was taken directly from the piles for all tests up to and including run No. 52 of the hemlock series, with the exception of runs Nos. 49, 50 and 51, the wood for which was soaked in the pond for approximately two months before being used. The only jack pine soaked was that used in the commercial test on seasoned wood of that species—run 14. The jack pine and spruce used in tests on mixed pulps were in all cases dry before grinding. The wood for the tests was prepared approximately 2 cords at a time, sawed into 2-foot lengths, barked, weighed, and piled up for the grinding process.

To determine accurately the yield, the bone-dry weight per cubic foot of wood, as well as the percentage of moisture present, was determined in each commercial test. All

pockets of the grinder were filled, the pressure adjusted to the proper value, and the grinder started.

For the purpose of check and control, regular readings were taken of the various switchboard instruments, the indicating tachometer, the pressure gauges, and the recording thermometer. On short tests up to two hours in length these readings were recorded at five-minute intervals, but on longer tests the interval was increased to fifteen minutes. The speed, pressure, and other variables were maintained as nearly constant as possible. For instance, when one of the grinder pistons was raised the speed was brought back to the desired value by manipulation of the rheostat controlling the motor armature voltage.

During the qualitative and quantitative tests the pulp stone did not have an oppor-

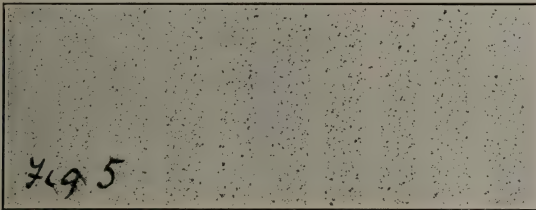

weighings were made in 500 or 1,000 pound lots, and the wood was used as soon as ground.

No attempt was made to remove knots or punky portions of the wood. In fact, all of the tests were carried on in accordance with the usual commercial practice.

#### Grinding.

Before commencing the grinding tests an impression of the surface of the stone which had been selected was taken by means of a piece of carbon paper and a sheet of coated paper. This impression was later photographed, as shown in the cuts (Figs. 1 to 6). In these the black dots represent projecting points and the white portions between them depressions in the stone. The surface shown in Fig. 5 is particularly interesting, since it is the result of dressing with two different kinds of burrs.

Before starting the tests the recording thermometer and all of the other recording instruments were placed in operation. The

tunity to heat up, and, in consequence, some of the data on power consumption and production may be more or less questionable. In the commercial tests, however, all of which were made under the hot-grinding process, the stone was brought up to a high temperature, which was maintained throughout the run, consequently these more nearly approximate commercial conditions.

#### Losses in Grinding.

To determine approximately the losses occurring in the conversion of wood to pulp, the bone-dry weight of screenings obtained from a known amount of bone-dry wood was determined. The loss in the white water was then taken as the difference between the bone-dry weight of the wood ground and the bone-dry weight of the pulp secured plus the screenings.

#### Fibre Study.

During each test the character of fibre obtained was examined by means of an apparatus for microscopic study. This con-

sists of an ordinary stereopticon provided with a specially constructed carrier for microscopic slides. Samples of wet pulp were taken from the wet-machine vat and slides were made by first removing the water by

ture. Evaporation or leakage was prevented by means of a thin strip of shellac around the edge of the cover glass.

With this apparatus it was also possible to compare different samples of pulp with

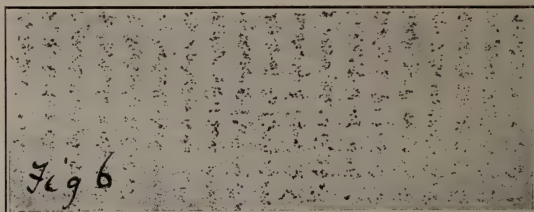

drying, then staining with Bismarck brown, and moistening with glycerine. The mixture of glycerine and fibre was teased out to cover the area of an ordinary microscopic cover glass, which was placed over the mix-

ture. Evaporation or leakage was prevented by means of a thin strip of shellac around the edge of the cover glass.

(To be continued.)

## *Tub-Sizing and Air-Drying of Writing Paper. American and British Systems Compared*

BY ALEX. ANNANDALE

During a recent tour, the writer was much interested to see the American system of handling papers sized and dried in the above way. As the process is generally carried out in America, the paper is partly or fully sized on the paper-machine, then (still while on the paper-machine) it is ripped into the required widths and run into shells. If the paper has been sized as hard as is required it is then cut into sheets and taken to the drying lofts, where it is hung on poles; but if the sizing has not been completed, the paper is again run from the shells through a narrower sizing machine, re-reeled again, then cut into sheets, taken to the drying room and afterwards, generally, glazed on a sheet calender.

Compared with this the British method is to make the paper at the machine, and reel it there the full width of the web. Then take the paper to the sizing machine, and pass it through the sizing tub in the usual way. In many cases this is re-reeled in the damp state, after passing through the tub; and allowed to stand for an hour or so, to allow the size to "settle into" the paper, before

being passed over the air-drying machine.

The drying machine is composed of a large number of skeleton drums, each of which has inside it, a rapidly revolving fan. Below these drums there are a number of radiating pipes heated by steam, or other heat-producing arrangements, which give a continuous supply of dry and hot air. This heated air naturally rises upwards (and is assisted in doing so by suitable ventilating arrangements) and is blown by the fanners against the web of paper and so gradually dries it, as it travels along the machine.

When the paper reaches the end of the drying machine, if required it can be slit into webs, for sale in that form, or for cutting and glazing, but the usual British method is to reel up the full width of the web. If it has to be plate, or sheet glazed, it is then cut, but if to be surfaced by super-calendering, it is treated in the full width, and then cut to the required size by revolving cutters, which take off deckle edges, and unless watermarked, cut to register. These cutters cut from four to six reels at once.



It may be mentioned here that the most modern British drying machines are capable of drying at the rate of 250 feet per minute, and not only do they dry the paper, but being fitted with two or more stacks of calender rolls, the paper can be given any ordinary amount of finish before being reeled; so that in many cases nothing remains to be done beyond cutting and finishing.

It appeared to the writer that the American method was more expensive than the British, especially as regards labor, and he looks at it in this way: Taking the paper from the end of the paper machine in both cases, and suppose a web of three sheets wide and that there was a good run to make and that the finishing house had to keep pace with the machine.

The American system would require three sizing machines, three calendaring machines and three cutting machines. That is to say 9 hands; and then for the drying room at least 2 hands would be necessary. That is a total of eleven hands per shift, or say 22 hands per day. British system would require: Sizing and drying machines, 3 hands; calendaring machine, 2 hands; cutting machine (with automatic catcher), 2 hands. That is 7 hands for 12 hours, but for the full day of 24 hours, only 12 hands would be required, because the revolving cutter cuts in 12 hours as much as the machine makes in 24 hours.

This would appear to represent a saving of 10 hands per paper machine as against the American system. But as much of the sorting in America is done at their single sheet cutters, it may be supposed that the single sheet cutting arrangement is adopted.

Already under the British system 2 hands have been allowed; let there, therefore, be four more hands added. This makes 14 hands for 24 hours, British system, against 22 hands, American system, or a saving of 8 hands under the British method.

Coming to machinery. The American system of working the narrow web (say three widths on the paper machine) would require three sizing machines and three calendaring machines. The British arrangement would consist of one drying machine, one sizing machine, one calender and one cutter. Probably the cost of the machinery, with the exception of the drying arrange-

ments, would be about the same in both cases.

As to the Drying. Pole drying means enormous loft space, consequently much expense for buildings, much expense in hoisting and handling the paper and probably more steam required for heating purposes than would be required to give the necessary heat to the much smaller space required for a drying machine. Against these apparent disadvantages, there is the first cost of the drying machine, which might be more than cost of lofts, etc., but this, in the writer's opinion, ought to be more than counterbalanced by the economy to be made and the nearer approach to a quick and genuinely continuous process.

There is supposed to be some difference in the results obtained in hardness and surface of papers treated by the pole drying system. But the writer feels sure that with properly prepared fibre, and a modern drying machine there should be little difficulty in making so close an imitation of pole-dried paper, that no ordinary buyer would be able to tell the difference.

After endeavoring to set aside any bias caused by personal experience and considering all points, the writer is of the opinion that the air-drying machine is more economical, more convenient and quite as suitable for practically almost all classes of machine made papers as pole-drying.

---

#### CHARLES HENRY JOHNSON.

We regret to report that Charles Henry Johnson, chairman of Directors, C. H. Johnson & Sons, Limited, Montreal, wire manufacturers, died suddenly at his son's residence in Montreal, August 3rd, 1912, aged 77 years. His sudden death was a great shock to his friends, as he had arrived from England with Mrs. Johnson, only three weeks before, intending to spend a few months in this country. Mr. Johnson retired from active business ten years ago, but had spent all his business life previously in the direction of affairs at the English works of the company. He was conspicuous in charitable and benevolent work and will be missed by a large circle of friends.



## Paper for the Lithographer

By Chas. Harrap

*Concluded from last issue*

As references have already been made to the character of the pulp and to the coatings on the paper, it almost seems superfluous to repeat that the presence of any compound of sulphur is inimical to the use of any delicate metallic pigments, as printing inks. But there are other ways in which the use of sulphur papers causes trouble in the printing processes. Some time ago I had a sample brought to me of some work which had been carefully stored away, ready to be sold when a demand was made. This work was in color, with two bronzes; and in the course of time the bronzes had become tarnished. The gold bronze had almost gone brown, the silver had suffered very little. Upon close examination of the details of the method of preservation it was found that a thin paper had been placed between the sheets. This paper was a coarse, harsh interleaving tissue, and had been used quite innocently of its manufacture. In truth it was a sulphite wood paper, and the sulphur had acted on the copper of the bronze and had converted it into this dark sulphide of copper. One example such as this should make the manufacturers much more careful in selling paper to others who retail it without any knowledge of the purpose for which it will be used. If it had been labelled as made from sulphite wood the user would alone have been to blame for the loss of a large quantity of good stock. It should be remembered that we as a nation do not carry on commerce simply in the sense of buying and selling, but rather in supplying the proper article for the purpose; and it reflects upon our moral standing if we in our culpable ignorance allow a man to use our manufactures, simply because he has bought them, and is also ignorant of the effects of their use, when we are in a position to supply trustworthy information and save the loss of so much material and time.

With the knowledge of the paper as required by the lithographer, and already dealt with in detail, it should be the aim

and art of the paper-maker to do his utmost to fulfil the conditions—stringent though they be—in which the lithographer is placed, by using the best materials which can be obtained for the purpose. It may cost more to get the ideal paper, but the saving in the actual printing process would more than compensate the printer for the extra outlay. The best paper is obtainable, as evidenced by the fact that there are printers who will only use certain makes of coated papers which are produced in Germany. In most of the fine lithography which comes from Germany it is noticeable that the paper is of the very best. And if such papers were put on the market by British makers they would command a ready sale. It is perhaps not only in the material, but in the general process that there is an appreciable difference in the quality of the finished article. There is a difference of opinion on this point, as some paper experts are of the opinion that certain British makers produce papers equal, if not better, than any other makers' in the world.

Other than the special points which have been raised, and to some extent discussed in detail, there are several general considerations which will show in a broad way the nature of paper as it affects the printer.

The great quantity of color printing which is executed to-day occupies a large and intelligent body of workmen—men who have devoted time and energy to the full development of the art, and have tried every means to secure the best results with the means at their disposal. It is from such sources that we are able to obtain the particulars of the paper required, as well as the processes which are applicable to certain papers before good work can be produced. It is in color printing that the great care is exercised in the selection of paper. The important character of paper for this form of printing is that the paper shall have a sufficient body or substance to carry or absorb a series of pigments in the form of oily inks, without difficulty, and

without giving an objectionable gloss. In the paper trade there are probably dealers who will not conscientiously guarantee any paper for this purpose; and in a sense they may be justified in so doing. But such papers are required, and the paper-maker should place upon the market papers which can be used with confidence to accomplish this work. In printing, the inks must be mixed with a varnish or similar medium, which is liable to dry on the surface in a hard impenetrable mass, and prevent the succeeding inks from drying on the surface without a gloss. The paper must therefore have sufficient body to allow a certain quantity of the oily medium to sink and become more or less absorbed, still leaving some on the surface to hold the pigment on the paper. This condition is an absolute necessity. Paper is made of varying thicknesses to accommodate this form of printing. And such papers do to a large extent meet the case. But they are not fit for the best work involving the use of many printings. For this purpose a paper is made with a coating on the surface composed of certain "clays" which will absorb a large quantity of the oily medium and leave room for the addition of still further colors. This paper should be carefully made so that the nature of the composition does not in any way damage the tint or hue of the color.

This kind of paper should also be indestructible, as the work has to be used in all positions and under all sorts of conditions. The so-called "Art" papers prepared for the letterpress printers, and frequently coming within the range of the lithographer, are the most delusive papers ever made. Its name of "Art" is about as far from the truth as a name can be. A paper which gives such a glossy surface that it is very difficult to read from it for any length of time, and which reflects so much light that it has frequently to be held at an angle to make it legible, is very far from what a good printing paper should be. Add to this that it produces every subject in such distinct outline that it loses all notion of "art" and the idea of it being an artistic medium vanishes. But it possesses a greater disadvantage still in its easy destructibility. Specimens of works exist in which the whole book has been rendered valueless by the

absorption of moisture, and the sheets have become glued together so fast that it makes it impossible to open them; and this is the paper to which some of the best writers' works have been committed for future reference. Many of the works of travel, which have been illustrated with monotone engravings, and with the best three-color work, have been printed on this paper, which in a single night, by some slight accident or oversight, may be irretrievably ruined. Such books placed on shelves which are in proximity with outer walls, or in any way are affected by damp, are liable to the same destruction. How different with the books of thirty years ago and more, before the "art" paper was introduced! Fortunately, this cause of loss can be prevented at the present time by the fact that all the best illustration work can be printed by the "offset" method upon any kind of paper. Not only can it be printed, but the style of the production is improved by this means of execution.

Other than the necessity of using paper with a substance for the many-colored work, there is the need of the thick and soft-bodied papers for the printing of the fine art work by engraving, etching, mezzotint and photogravure. These papers must be of the best material, pliable and indestructible, as they are used to receive prints from the original plates of the best artists of the day. Such papers are made use of also for printing colotype upon, and in other ways which make their manufacture almost indispensable. It might prove profitable for paper-makers to produce a paper of this kind for the making of the transfer papers which are in constant daily use in all lithographic establishments. The paper must be thick, and firm in fibre. It should not stretch to any serious extent, and it should be of a nature which will allow moisture to penetrate without causing the fibre to swell and become distorted.

There is yet one other kind of paper required having both thickness and great body. This is the one used for embossing. The extensive use of die stamping, with dies of great depth, necessitates the manufacture of a paper of a soft, pulpy consistence, which can be pushed out into high relief, without the possibility of the die perforating

the paper and allowing the embossed parts to drop out. Such papers are made successfully in Germany, and to a very small extent in England. They would be in greater demand if they could always be obtained from home houses of a character that would commend them.

Leaving the points which appertain to the actual manufacture, and touching upon the paper as supplied to the customer, there are, amongst other small considerations of a ready means of detecting the right and the wrong side, such larger matters as the series of sizes to which the papers are cut, and the number of sheets to the ream.

Is it possible that any maker ever gave any study to the reasons which govern the cutting of paper into so many and such ill-defined sizes? In the first place, why should there be any difference between the size of a printing and a writing paper? We know it is so, but as to why it is so yet wants explaining. Again, if a name of a size is represented by certain inch measurements in one case, why is the size changed when another material is made up? To be more definite, it may be said that there is no empirical law which establishes the size of paper as it does the one-pound weight. Paper-makers are at liberty to cut up to any reasonable standard of sizes without incurring any legal disability or any censure of the trade. In fact the trade would hail with delight the abolition of several of the awkward sizes and the introduction of something uniform. It cannot be argued that books are printed to those sizes, for books are now printed to all or any size that the customer requires. And it is well known that the fads for odd-sized books has grown almost into a fashion. The cut sizes of papers are regarded to a very small extent by customers, it is the printer who has all the trouble with the different sizes, to meet the customers' wishes, often involving a large amount of waste. To make the sizes more uniform could not lead to more waste than at present, but might result in a saving. The first step in the direction of uniformity would be to abolish some of those sizes which are so nearly alike, and to bring all the regular sizes to whole numbers of inches without the use of fractions of an inch.

#### PULP RESOURCES OF LABRADOR.

Opinions seem to differ as to the resources possessed by Ungava or Labrador in the matter of lumber and pulpwood, some who claim to have explored large sections of the peninsula claiming that these are very much less both in quality and quantity than is supposed. Senator Edwards, of Ottawa, however, who should be a good authority and who spent a considerable sum in exploration work in that region says:

"Back some distance from the Labrador coast and in the immediate valleys of all the streams in that district the timber is large; also in the district around Hamilton Inlet, around Melville Bay, up the Hamilton River, in the valleys of all the rivers running into Hamilton Inlet, and also in the valleys of the rivers extending from Chateau Bay to the head of the island of Anticosti. The timber within these areas is large and good, but the strips do not extend back from the streams for any distance. From half a mile to a mile on each side of the streams would be the extreme. On the mountains is a vast quantity of perfect timber. The objection to it was that it is scrubby. However, the time will come, if that timber is preserved, when it will be very valuable. Fires, however, extend over vast areas, and enormous portions of the country have been burned. On the mountains around Hamilton Inlet there is the states, an enormous quantity of pulp wood."

The Senator also describes the Grand Falls at Hamilton Inlet as one of the best water powers in the world, possessing an enormous head, whose power, however, he would not venture to calculate.

---

The Wayagamack Pulp & Paper Co. expect to begin operations this month. The pulp mill will turn out 200 tons daily, the paper mill 50 tons of Kraft daily.

\* \* \*

The Beaver Board Co., Ottawa, has started work on the erection of a large new plant at Beaverdale, near Deschenes, Que.

**USE FOR SULPHITE LIQUOR.**

The Pulp and Paper Magazine has discussed on previous occasions the methods of utilizing sulphite liquor and other by-products from the manufacture of pulp and paper. The following description of "sulphite pitch" used as a binding material for the treatment of blast furnace and flue dust, will prove of interest. It is also used on the continent in connection with the briquette industry. This is the way in which it is prepared at a German mill:

In the preparation of paper pulp by the sulphite process, wood is boiled under pressure with sulphurous acid, and a hydrolysis resulting in the formation of certain complex organic acids occurs. The resulting liquors are strongly acidic, and so require to be neutralized by the addition of lime before concentration by evaporation. The evaporation is carried out by means of a sextuple-effect Kestner evaporator, and the resulting fluid is converted into a solid pitch by two drums heated by steam, which dip below the surface. About 10 lbs. of waste lye are necessary to yield 1 lb. of dry pitch.

The pitch is soluble in water, and has the appearance of a black, opaque resin. Experiments and practical trials have proved it to be eminently suitable as a binder for fuel and ore briquettes. For example, the dust from blast furnaces—a waste product containing 30-40 per cent. of iron—can be briquetted by its use and resmelted. Breeze and small coke, which have proved practically untreatable by other means, are transformed into briquettes capable of sustaining the severest treatment in the furnace without cracking or shrinking. Practically all fine ores, such as bog iron ore, manganese ore, brown ore, etc., can be briquetted into a form suitable for melting purposes. The saving which is thus possible in works where the accumulation of such fine material is unavoidable should be very great.

The process of manufacture is simple and inexpensive. The pitch is dissolved in the correct amount of water, and then, with the material which it is desired to bind, is fed into a mixing machine. After thorough mixing so as to ensure uniformity, the matter is taken to a rotary drying kiln, and, after being dried, the briquettes are ready for

shipment—that is, unless it is desired to render them waterproof, in which case they are passed through an emulsion of water and bitumen and then dried.

Little labor is necessary; the cost of production is small, the chief point being the use of the correct amount of binder and fine material. It is interesting to note that this process has been selected lately for the the State collieries by the Hungarian Government. It is made additionally valuable also by the fact that hitherto the liquids from the paper manufacture have been allowed to run into streams, frequently exercising harmful effects and causing serious pollution.

---

**CHAS. WALMSLEY & CO., LTD.**

The high state of development reached by British manufacturers of paper machinery is exemplified by the works of Chas. Walmsley & Co., Ltd., at Bury. Since 1910 this well-known firm has received orders for no less than 18 of the largest paper making machines. Two of these huge machines were supplied to Edward Lloyd, Ltd., Sittingbourne, and produce over 500 tons of paper per week. They also have four running successfully at the Imperial Paper Mills, Gravesend. Mr. A. Wood, the energetic manager, has just booked an order for two more 168-inch machines for this plant, making six Walmsley machines in all. On some of them the bottom calender roll weighs no less than 16 tons. Messrs. Walmsley's works have grown greatly in recent years, large increases in space and facilities having been necessitated by the rapid growth of business.

---

Mr. Geo. Hall, of London, Eng., was a recent visitor to this office. He is a well-known paper man, acting as agent for Jeremiah Lyon & Co., merchant shippers, London, Manchester, and Birmingham; Chas. E. Corke & Co., paper mill agents and merchants, London; Felber, Jucker & Co., paper merchants, London, Manchester and Glasgow, and Basted Paper Mills Co., Ltd., Kent, and may settle in Canada as representative for these firms.



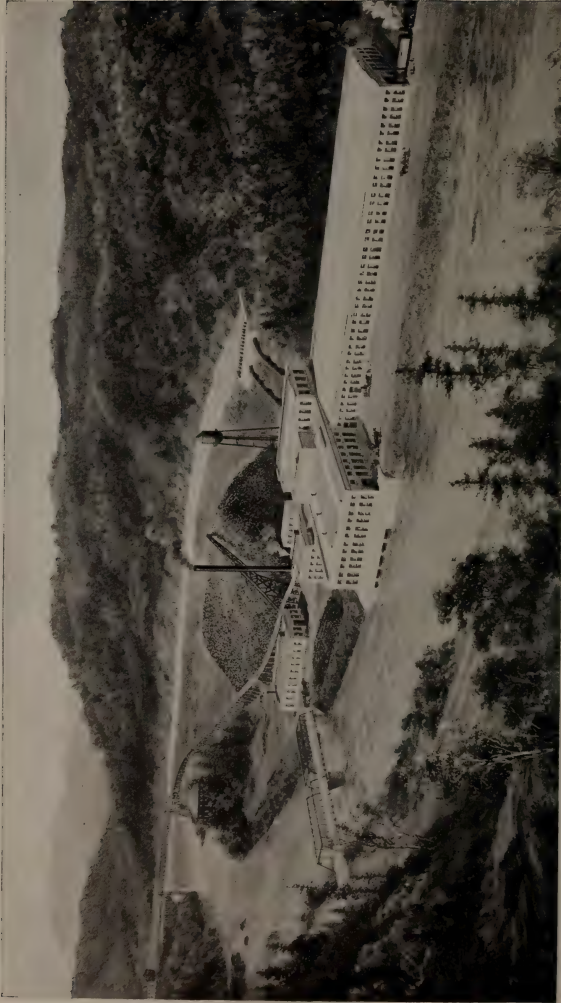

This illustration and the one on the opposite page show the plant of the East Canada Power & Pulp Co. at Nairns Falls, Murray Bay, Que., which recently started operations, producing nearly 120 tons pulp per day. Dam and buildings were constructed by the Bishop Construction Co., Montreal and Toronto.



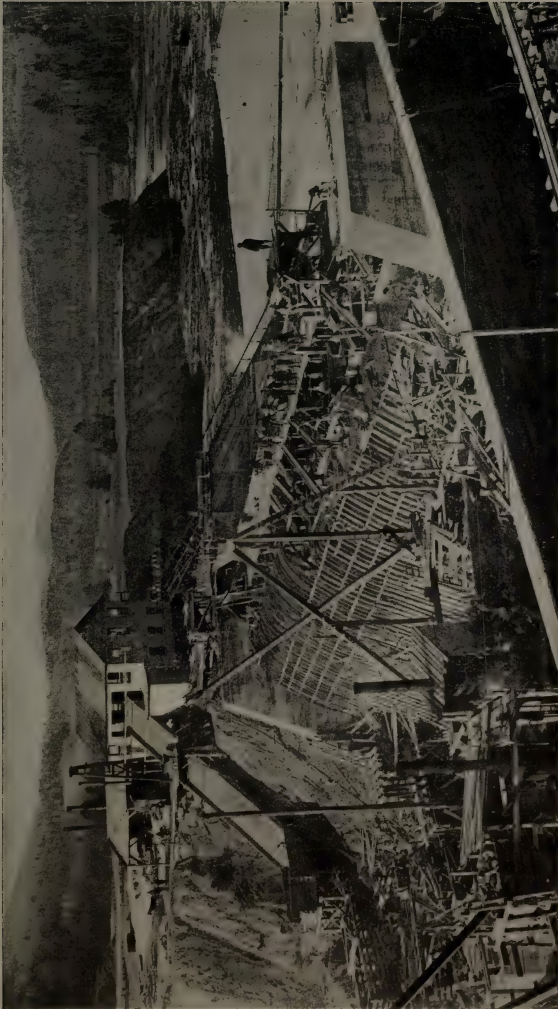

Another view of the fine new plant of the East Canada Power & Pulp Co., near Murray Bay, Que., showing the cutting-up mill and concrete gravity dam, 55 feet high, under construction by Bishop Construction Co., Montreal and Toronto.

## Improvements to Fourdrinier Machines

W. H. Millspaugh, Sandusky, O., has patented an invention, the purpose of which is to improve the operation and increase the capacity of Fourdrinier machines and to improve the product of the same.

Fig. 1 represents a portion of an ordinary Fourdrinier machine with this invention embodied therein; Fig. 2 is a view showing the rotary pump connection with the suction roll being shown in longitudinal vertical section and the pump being shown in side elevation. Fig. 3 is a cross sectional view of the rotary pump. Fig. 4 is a detail sectional view on line 4—4 of Fig. 2, looking in the direction of the arrow. Fig. 5 is a detail section on line 5—5 of Fig. 2. Fig. 6 is a diagrammatic view of the delivery end of

ceiving tanks in connection with such pumps, which are very cumbersome and open to many objections and seldom if ever accomplish the desired result.

In this invention a suction roll is employed in combination with a positive rotary vacuum pump capable of maintaining a substantially uniform vacuum in the vacuum chamber or chambers of the suction roll while handling large volumes of water and air, and thereby draw heretofore supposedly impractical volumes of air uniformly through the wet web or sheet, preferably as it leaves the making wire; and by subjecting the wet web or sheet to the action of such constant vacuum at the suction roll, the inventor claims to be able to practically accomplish

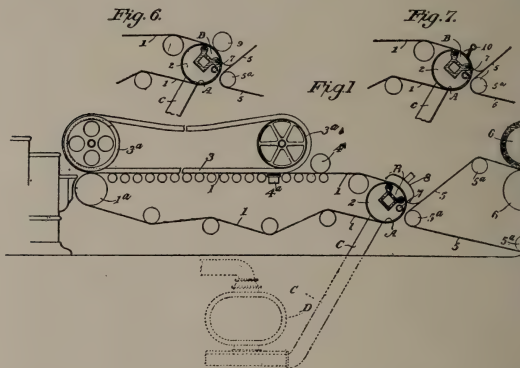

the wire with a smoothing or dandy roll used in co-operation with the suction roll. Fig. 7 is a similar view showing the use of a coloring appliance.

According to the patentee, on fast running Fourdrinier machines, as ordinarily constructed, whether equipped with flat suction boxes or a revolving suction roll, the wet web or sheet is treated unequally because a certain proportion of the sheet goes by the suction boxes without the proper amount of air having passed through same, and portions are unequally dried. Reciprocating piston pumps are commonly employed in Fourdrinier machines, and such pumps cannot produce uniform suction or air current except by the use of very large vacuum equalizing or

by one suction roll and a positive rotary air pump the work of many parts heretofore required in Fourdrinier machines, and to increase the capacity of such machines by eliminating sources of breaks in the wet web and delivering the web or sheet to the presses and dryers in a much dryer condition than at present, thus greatly facilitating the drying and enabling the speed of the machine to be greatly increased, and also to produce a better grade of paper of smoother finish, free from wire marks and substantially free from felt marks; and when the patentee's invention is applied to such Fourdrinier machines such heretofore necessary parts are dispensed with and may be removed from the machine, while the latter will neverthe-

less, it is stated, be capacitated to produce more and better paper than it could originally do. It is also claimed to be able to maintain sufficient vacuum in the suction roll to lock the making wire firmly to the revolving shell or cylinder of the suction roll and utilize the latter to drive the making wire.

An additional advantage of carrying such large and uniform volumes of air through the wet paper web is that the wet web may be sufficiently dried at the suction roll to enable it to be picked off the making wire safely and more easily than would be possible in the ordinary methods of making paper with a top couch roll.

Referring to the drawings, 1 represents the usual Fourdrinier making wire which passes over a breast roll 1a and over a suc-

machines ordinarily have two couch rolls, which receive and squeeze out the water from the wet paper web and pass it from the making wire 1 to the press felt 5.

Mr. Millspaugh removes the upper couch roll and its appurtenances and puts the suction roll 2 in the place of the lower couch roll, and extends the making wire 1 over this suction roll 2, which is utilized and employed, both for substantially drying the wet web before it is delivered to the felt, and for driving the making wire. This is accomplished by the maintenance of such heavy uniform vacuum as to draw large volumes of air uniformly through the web or sheet.

In addition to eliminating the top couch roll, together with its couch housing, guard boards and jacket, all or a part of the flat

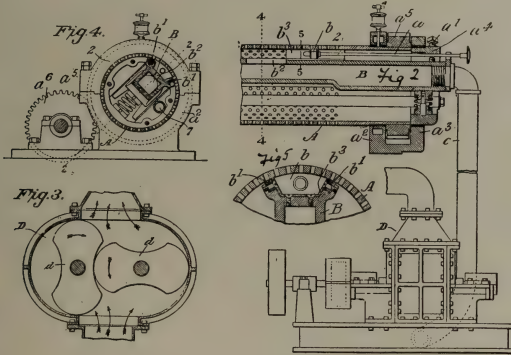

tion roll 2 (located in the place of the usual lower couch rolls) and also over an intermediate series of table rolls supporting the upper run of the making wire as usual in such machines; the lower run of the making wire passing over suitable guiding and tensioning rolls as usual. The deckle straps 3 running over the pulleys 3a are arranged above the upper run of the making wire as usual. 4 is the dandy roll; 5 is the receiving press felt running over suitable guide rolls 5a, as shown to the first press rolls 6.

The parts thus far described, except the suction roll, may be constructed and arranged substantially as in any ordinary Fourdrinier machine; but at the point where the patentee has the suction roll 2 the Fourdrinier

suction boxes usually employed in Fourdrinier machines are, or may be dispensed with. This reduces friction on the making wire and prolongs the life thereof, and by reducing friction lessens the power required to operate the wet end of the machine. When the invention is applied to an ordinary Fourdrinier machine, the patentee preferably discards all the flat suction boxes except that one (4a) required to remove water for dandy roll purposes, or to hold the edge of heavy or slow sheets between the deckles and the suction roll; but where a dandy roll is not needed said suction box 4a can be dispensed with by having the deckle straps extended down to the suction roll, thus reducing wear and drag on the making wire.

Referring to the suction roll, which may be of any form capable of maintaining a vacuum on a portion of cylindrical surface, it is preferred in view of the heavy vacuum maintained to employ a suction roll having provision for maintaining its suction box in air-tight contact with the inner surface of the revolving shell or cylinder, so as to effectively utilize the vacuum, and for limiting the pressure of such contact to prevent the suction box from becoming locked to the shell or cylinder under influence of the vacuum, with consequent wear, and also increased driving power; whereby the patentee is enabled to operate the suction roll safely while maintaining such heavy and constant vacuum as necessary to pass the desired large and uniform quantities of air through the web or sheet of paper and to cause the external air pressure upon the web to lock the making wire to the cylinder so that the means which rotate the cylinder may also be utilized to drive the wire. A. indicates the revolving cylinder of suction roll, containing one or more suction boxes B., in contact with inner surface of cylinder and extending from where the making wire meets suction roll to a point where the web is stripped from same and carried over to press felt 5.

The pipes C., leading from suction box B., are connected to a high-power positive acting rotary air pump D., constructed with two oppositely revolving cycloidal impellers or pistons, d, working in an oblate case, shown in Fig. 3, and adapted to produce a continuous high-tension uniform draft, or vacuum, in suction box B. The impellers cannot touch each other or the case in whatever position, and there is, therefore, no internal friction. The cycloidal outline of the impellers results in continuous long contact and uniform exhaust. The pump is driven in a way to draw through the wet web or sheet passing over suction box B such large constant volumes of air as will practically remove all of the free moisture from the wet web at this point and consolidate the web on the making wire; and at the same time, because of the uniform external pressure due to the suction, the web will cause the making wire to adhere or lock to the surface of the rotating cylinder A, which thereby is enabled to drive the making wire accurately and effectively,

doing away with supplementary means for driving this making wire such as are commonly required in the Fourdrinier machines. As the usual friction over flat suction boxes is removed the wire will moreover drive easier than at present.

By reason of the large and uniform constant volume of air obtained by the use of this positive rotary air pump, no portion of the wet web of paper can pass over the suction roll without being thoroughly and uniformly treated, and by this treatment the sheet of paper is substantially freed from water without squeezing and is passed to the first felt and thence to the presses much drier than it is possible to carry same using the common equipment of flat suction boxes and top couch roll, and this increases the capacity of the machine as there is less moisture in the sheet to be removed by the presses and by the driers, thus greatly facilitating the operation of the driers.

---

#### DILLON MACHINE CO.

At a meeting of the stockholders of the Dillon Machine Company, manufacturers of paper mill machinery, Lawrence, Mass., William Morrison, Jr., was elected president and treasurer of the company. F. N. Chandler, R. J. Dillon and William Morrison, Jr., were elected directors.

Mr. Morrison has been with the company for the past fifteen years and for the last three years as manager. He has purchased one-half interest in the company. The new management will make several improvements on the present machinery which they build and will add some new lines of paper mill specialties.

F. L. Winkley, for some years connected with the mechanical department of the company, is now representing that company on the road, visiting paper mills in connection with orders for machinery.

---

L. Grey, who was formerly connected with the mills at Sturgeon Falls, is said to be interested in a project to build a 75-ton sulphite mill at Thorold, Ont.



## Testing Permeability of Paper to Air

Professor W. Herzberg, at the recent meeting of the Association of Cellulose and Paper Chemists described in an interesting manner some hand apparatus for determining the permeability of paper to air, which merits special attention. This is of considerable importance in some kinds of paper, notably those employed for wrapping certain articles of food, condiments, etc., such as cocoa, tea and spices, and as a means of determining the extent to which paper can

This siphon conducts water from the bottle C into A; into the bottle C water flows from any convenient source; it is provided with an overflow, so that the water it contains stands always at the same level. On removing the pinchock from the rubber tube, water enters the cylinder A and displaces the air it contains. This displacement occurs the more gradually the less permeable to air the paper, stretched over the cylinder, is. Sindall measures the time it takes for the cylinder A to become full of water, reverses the calculation and ascertains in what time 100 cubic inches (English) of air would pass through a paper surface of 10 square inches. The number of minutes thus obtained is the standard of permeability to air.

The results would have been still more valuable if the papers experimented had embraced a larger number of parchment, parchment substitute and pergamine papers, because these papers, for packings as airtight as possible, are of the first importance.

The proposition to test the permeability of paper to air in the manner described is not new, so far as the fundamental idea is concerned. It had been proposed, as early as 1902, by Winkler-Karstens, who used for the purpose a very simple apparatus. (Fig. 2.) A glass A, open at both ends, by means of a suitable arrangement was closed at the top by the paper to be tested and then immersed in a vessel (B) filled with water, until the water in B stood 10 centimeters higher than in A. The air in A would now be under pressure, it would escape gradually through P, and as soon as the water-level in A was equal to that in B the test was completed.

Both methods have the disadvantage that the pressure under which the air escapes through the paper steadily decreases during the test, consequently a constantly decreasing volume of air is forced through during the period. This unnecessarily prolongs the test.

A further disadvantage of the process consists in the fact that the air escaping through the paper is very moist, increases

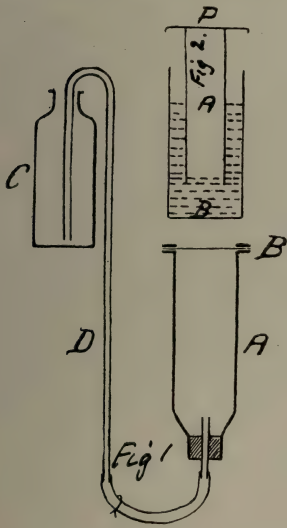

be permeated by air. The process and apparatus illustrated herewith (Fig. 1) were designed by Sindall.

In Fig. 1, A is a glass cylinder, the edge of which, B, is turned over and ground leveled. On this a thin rubber ring and the sample of paper to be tested are laid, the whole being securely held against the rim by a brass ring and several metal thumb screws. The lower end of the cylinder is closed by a rubber plug, through a hole in which a glass tube passes, which, by means of a rubber hose, is connected with the siphon D.



in humidity during the test and consequently the physical character of the sheet constantly changes, until the termination. The fibres swell and contract the passages through which the air escapes.

The question of the permeability of paper to air can therefore not be regarded as unequivocally solved. First of all an

apparatus must be constructed that will insure the air, during the entire test, passing through the paper under uniform pressure, nor must the humidity of the air change during the test. It would be best to select for these tests a humidity of 65 per cent. at which point strength, expansion, resistance to folding and durability of sizing of papers are already determined.

## Cheap White Glazed Paper

In glazed paper the two qualities exacted are cheapness and whiteness. The necessary materials are unbleached sulphite-cellulose, mechanical wood pulp, old paper and filling and sizing materials.

Unbleached sulphite cellulose is, of course, more or less charged with splinters, and must consequently be thoroughly well rolled, and then not too wet. The splinters are thus disintegrated and the cellulose improved in strength, apart from the relief given to the engines.

Still further to improve the cellulose, 3 to 4 per cent. chloride of lime can be added, when the length of the run must, of course, be somewhat extended, and the rolled pulp be allowed to stand for a while in the tanks in order that the chloride of lime may be fully effective.

For the wood pulp only spruce is employed, not fir. The wood must be worked up as soon as possible after being felled, and care must be taken to form a greasy pulp, which is clean, free from splinters, and as white as possible. Spruce gives a yellowish-white, fir a reddish, darker pulp. The knots only need boring out when there are specially stringent requirements regarding the purity of the paper. At grinding, a little shower obtained by the second use of the waste water is employed. For the sorter, sheets with from 0.8 to 1 mm. holes are used. In districts where newly felled aspen (*Populus tremula*) can be obtained, a certain percentage of this may be added. Aspen pulp has drawbacks due to the difficulty in sizing, to the dark-colored knots, which must be bored out, and to the sponginess of the pulp.

The bleaching of wood pulp is of great importance. For instance, take a pulp mixture of:

20 per cent. sulphite cellulose, unbleached.  
10 per cent. waste paper, and  
70 per cent. spruce pulp bleached,  
gave quite as white a paper as  
10 per cent. sulphite cellulose, bleached pure white,  
15 per cent. sulphite cellulose, unbleached,  
10 per cent. waste paper, and  
65 per cent. spruce pulp, unbleached.

The cost of the latter pulp was 60 pfg. per 100 kg. higher, and would cause, with a daily production of 12,000 kg., a difference in cost in one year of 21,600 M.

The bleaching agent suitable for wood pulp is sodium bisulphite in the powdered form in which it is procurable from some chemical works. Of this bisulphite a solution of 1 degree B. in cold or warm water is made. For this purpose a wooden box with a perforated bottom is hung in a vessel beaten out of lead, and then sufficient water run in to immerse the sodium bisulphite, which quickly dissolves.

The most rational use of the solution is on the drainage machine. On the form roll lies a felt-covered roll, on which the bleaching solution drops from a lead shower-pipe and so becomes uniformly applied to the wood pulp. The form roll is preferably of beech with a groove of copper or bronze for opening out the size. With scraped pulp a piece of felt is arranged to slide on the run of stuff, and receives the bleaching solution, which trickles on from a lead spurt-pipe. The upper pressure roll and the scraper must be of acid-proof material, e.g., phosphor-bronze and delta metal. The wood pulp treated with sodium bisulphite must be stored for at least 48 hours before being used.

Should purchased wood pulp need to be bleached, the sodium bisulphite solution can be added in the edge-rolls. Bleaching can

be intensively carried out by stacking on edge the boards or packets in a beton tank, then running in the bleaching solution till the wood pulp is covered, and then allowing the whole to stand for two or three days. The bleaching-liquor is then drawn off, and the tank filled two or three times with fresh water, the wood pulp then being effectively bleached.

The working-up of old paper gives a paper of good printing qualities and opacity, and of a uniform texture.

When purchasing filling materials it should be remembered that a higher price is more than compensated for when more of these substances remains in the paper.

For giving a slight tint to these printing papers, the following are employed: Victoria Blue B, Rhodamine G, Auramine P, Paper Yellow A, and Saffron T; Water Blue I.N. is somewhat affected by the bisulphite in the wood pulp, and cannot, therefore, be here used.

Further conditions for success in manufacture are:

1. A not too hard, clean, clear mill water;
2. Engines having bronze gearing and beton tanks, and giving an easy circulation to pulp of the greatest density;
3. Efficient edge-runners;
4. Copper pipes for the pulp;
5. Scrupulous cleanliness with all objects coming in contact with the pulp;
6. Efficient sand-trap and straining plant, with 0.4 to 0.5 mm. width of slot;
7. A correspondingly efficient paper machine, and
8. Efficient serviceable calenders.

These printing papers vary in thickness from 50 to 70 g. per sq. m. and are worked at 80 to 110 m. per min. Dandy rolls should be always used, and the paper on the paper-machine be given as smooth a surface as possible. Moistening should be done on the machine itself and the rolls kept in a cool room. For glazing purposes a twelve-roll supercalender with two case-hardened rolls gives at one passage of the paper the desired smoothness without diminishing its whiteness.

### ALUMINIUM SULPHATE IN SIZING SULPHITE PULP.

Professors C. G. Schwalbe and H. Robsahm show by experiments made in Germany that when 3 per cent. of aluminium sulphate was added to a mixture of unbleached sulphite wood pulp with about forty times its weight of distilled water, the whole of the aluminium was precipitated on the fibre in the form of hydroxide. The sulphuric acid remained in the water, partly in combination with calcium derived from the wood pulp, but partly also in combination with organic matter in a neutral form not yet investigated. When the same experiment was repeated, using hard town's water instead of distilled water, the precipitation of the aluminium hydroxide was not quite complete: about 3.2 per cent. of the alumina added remained in solution. Moreover, it was found that the hard water alone, without the cellulose, was capable of precipitating about 84 per cent. of the alumina in the aluminium sulphate added. Rosin size had an effect similar to that of the hard water, 3.4 per cent. of the alumina remaining unprecipitated, whilst the sulphuric acid combined partly with the sodium and partly with organic matter. When 6 per cent. of aluminium sulphate on the cellulose was added to the pulp with the rosin size, 53.7 per cent. of the aluminium sulphate remained in solution, showing that the precipitating power of the cellulose is at a maximum with about 3 per cent. of aluminium sulphate, and is slightly diminished by an excess of that salt. If the sized pulp be extracted with ether, the quantity of resin remaining insoluble in ether is only slightly greater in the pulp treated with 3 per cent. of aluminium sulphate than in that treated with 6 per cent. Hence it is concluded that only a small proportion of the alumina added is precipitated in the form of aluminium resinate, the major portion being precipitated as hydroxide by the action of the cellulose. No basic aluminium sulphate is precipitated, since the percentage of sulphuric acid in the sized cellulose is smaller than in the original pulp.

Plans are being made for additions to the book and coated paper mills of the Barber Paper & Coating Co., Georgetown, Ont.

The Canadian Fairbanks-Morse Co. will increase its capital stock from \$2,600,000 to \$3,100,000.

## Trade and Manufacturers' Notes

We are informed by J. Marx & Co., 133 and 139 Finsbury Pavement, London, E.C., manufacturers of the Margalt Suction Roll and other well-known paper machinery, that they are introducing complete paper machines, embodying the most modern European practice adapted to Canadian conditions. In the near future they will place on the market a large Fourdrinier and a high-production board machine.

\* \* \*

Mr. R. S. Lea, Mem. Can. Soc. C. E., Mem. Am. Soc. C. E., M.I.C.E., has recently removed his office from 405 Dorchester St. West, to Room 820 New Birks Bldg., Montreal. Besides conducting a consulting practice of his own, Mr. Lea is associated with H. S. Ferguson, 200 Fifth Ave., New York City, under the name of Lea & Ferguson, Consulting Engineers for paper and pulp mill equipment and hydraulic developments.

\* \* \*

P. P. Westbye, Consulting and Designing Engineer, Peterborough, Ont., and manufacturer of the Westbye & Ruth Centrifugal Pulp Screens, has invented and patented a new centrifugal pulp screen, which we understand has many new and novel features. The screen has been tested in the United States, and has a very high capacity. It is very heavily built, and is driven with direct belt or can also be connected to electrical motor direct.

\* \* \*

The Jeffrey Mfg. Co. have moved their Chicago headquarters and offices from the Fisher Bldg. to the McCormick Bldg., recently completed and which is considered the most modern and up to date fireproof office building in Chicago. Mr. S. S. Shive, sales engineer, is the district manager in charge of the Chicago office, and Jeffrey customers and friends will find a welcome on the 17th floor where the Jeffrey offices are located. The Jeffrey Mfg. Co. maintain fourteen branch offices in the United States and over one hundred agents in the leading commercial centres all over the world.

\* \* \*

E. D. Jones & Sons Co., Pittsfield, Mass., have received the order from the St. Lawrence Paper Mills Company, Ltd.,

Montrose Division, for their equipment of beating and paper washing engines. The order consists of three beating engines, three wood tub paper washing engines, and two iron tub paper washing engines, also one direct connected motor driven Jordan. The same firm have received the order from the Rolland Paper Company for three wood tub beating engines, one iron tub rag washing engine, and one iron tub bleaching engine.

\* \* \*

The Rolland Paper Company, Ltd., are erecting a large paper mill at St. Adele for making loft dried bond and ledger paper. George F. Hardy, of New York, is the engineer. Messrs. Jos. Fauteux & Co., of Montreal, are the contractors. The paper machine is being built by Messrs. Black-Clawson, of Hamilton, Ohio. The result of these extensions, which are expected to be completed about Nov. 15th, will be that the company will have double its present capacity and that they will be in position to handle their business in a still more satisfactory manner.

### JEFFREY STORAGE BATTERY TRUCKS.

The above-named truck was designed some five years ago for the Jeffrey Mfg. Co.'s own use, as they needed better facilities for transporting their various raw and finished products from one part of their enormous plant to another. They have now three of these trucks in constant operation, as they save a good deal of expense, besides facilitating the handling of orders. In order to have a more exact idea of what these storage battery trucks can accomplish in the way of transporting material in large modern industrial plants, we obtained a report on the subject from H. W. Arnold, supervisor of power and maintenance for the Jeffrey Mfg. Co. This report shows that the Jeffrey Mfg. Co., of Columbus, Ohio, is spread out over an area of approximately 26 acres and has 18 acres of floor space. Throughout the shops of this company a high degree of efficiency has obtained for some time, but the matter of transporta-

tion of raw and finished material did not receive until a few years ago adequate consideration.

was served by a Jeffrey Storage Battery Truck working on a 36-inch gauge industrial track. A careful study of existing condi-



**Jeffrey Storage Battery Truck.**

Up to that time the raw and finished material was being transported to and from cars in and about the various shops and

tions made plain the fact that a very material saving could be effected by establishing a more efficient transportation system.



**Jeffrey System of Truck Transportation.**

departments by means of two-wheeled warehouse trucks, four-wheeled trucks and industrial cars. Also, part of the territory

After considering the problem from every angle it was decided that the Jeffrey Storage Battery Trucks and industrial cars offered



the best and most efficient means of surface transportation. Accordingly, the industrial railway was extended to take in all departments and a systematic method of car dispatching established.

As soon as this system was established, very rigid instructions were issued that absolutely no material was to be transported by other means than by the Storage Battery Trucks and industrial cars. It was immediately found possible to dispense with the services of a two-horse team, 28 two-wheeled warehouse trucks, 13 four-wheeled trucks, 8 wheelbarrows and 18 men whose whole time had been devoted to this purpose. This effected a saving of more than \$600 per month over the cost of the former system, taking into consideration the interest and depreciation on the investment, operating, maintenance, costs, etc. The monthly tonnage handled is close to 4,000 tons. Viewed from its present efficiency, it would seem almost an utter impossibility to go back to the previous or any other method of transporting material.

The Jeffrey Storage Battery Truck is so simple in design and rugged in construction that it does not require the service of skilled operators, and the maintenance and operating costs are extremely low.

Pulp and paper mill men should be particularly interested in this equipment, owing to the large quantities of heavy material which have to be transported every day in such plants. We imagine these trucks should pay for themselves in a very short time, especially where the industrial track system is already installed. The Jeffrey Mfg. Co., Columbus, O. (and Montreal, Que.), inform us they would gladly demonstrate to interested parties, further details of the system they employ for despatching trains, without loss of time, thus securing the greatest efficiency.

#### THE MARGALT SUCTION ROLL, ETC.

Mr. Renold Marx, B.Sc. (London), who has been on a prolonged visit to Canada and the United States on behalf of his well-known firm of J. Marx & Co., paper makers' engineers, London, recently supervised the installation of a Margalt Suction Roll at the Toronto Paper Mfg. Co.'s mill at

Cornwall. We understand that it is working very satisfactorily, and it is an astonishing fact that the pumps only take from 10 to 15 h.p. The engine is running other machinery as well, so that it is not possible to state the exact amount, but it is absolutely safe to state that it is something less than 15 h.p., which will certainly surprise those who believe that a pump of this character would require a large amount of power.

The following letter, received from the Toronto Paper Mfg. Co., will explain itself: (COPY.)

Cornwall, Ont., June 25th, 1912.

To Whom It May Concern:

This is to certify that we have started the Margalt Suction Roll and find that it is giving us a far better paper than obtained from the old couch roll, as the wire mark has entirely disappeared, and we are running the same product as before. We have been running this Roll for two days only and the writer is very well pleased with results so far.

Yours truly,

The Toronto Paper Mfg. Co., Limited,  
per H. C. Courtney, Supt.

The roll at the Cornwall mill is on a 90-inch wire, making book papers running up to about 200 feet per minute. The sheet is practically entirely free from wire mark; it also has a better appearance and is improved in bulk.

The company has several orders in hand for additional suction rolls in Canada. The general opinion among paper makers is that the mechanical construction is excellent and from what has been done already it is shown to be as represented, especially in regard to its low power consumption.

The following letter received from a prominent paper company in the United States is another illustration of this:

(COPY.)

The Champion Coated Paper Co., Hamilton, Ohio, U.S.A.

June 18th, 1912.

J. Marx & Co.,

London, England.

Gentlemen,—Regarding the two Margalt Vacuum Rolls which we have installed on our 150-inch and 138-inch machines, would say that both rolls have started out very satisfactory. We have been running them on



book papers from 40 pounds up to 150 pounds and have had practically no breaks on the suction rolls or on the presses.

We are greatly surprised at the small amount of power required by the rolls. The constant line shaft which is driven by a 50 h.p. motor, drives not only the pumps for the rolls, but also the agitators, stuff pumps, screens, shakes, fan pumps, and duplex suction pump, and they indicate only 42 h.p. each.

The paper made on the vacuum rolls shows very little, if any, wire mark.

Yours truly,

The Champion Coated Paper Co.,

(Signed) Peter G. Thomson, Jr.,

Vice-President.

The Marx Double Beater is also making good progress in Canada, particularly in the newsprint mills. It is becoming recognized that in order to produce a really good sheet of news, it is necessary for a certain amount of beating to be done on the stock. Heretofore it has been customary to make the sheet practically on the grinders, which means fine grinding. Tests, however, show that the harder the grinding, the greater is the yield per horse power from the grinder. In fine grinding, therefore, the grinders are actually being used inefficiently, and, in a large number of cases, apart from the greatly improved quality of the sheet, an actual saving is effected in the cost of production by grinding coarse and thus using the grinders to full advantage, and afterwards treating the stock for a short time in the double beater. The action of the double beater also being a refining one, the ground-wood slivers which frequently appear in the furnished sheet if made without beating, are entirely eliminated.

#### COMMERCIAL USAGES FOR PAPER AND PULP IN SWEDEN.

On account of differences having arisen frequently between the foreign buyer and the domestic seller in reference to qualities, quantities, terms, conditions of sale, etc., the Association of Swedish Paper Mills have adopted a number of rules and regulations applying to future orders. According thereto, the following information is required with an order:

Quantity, given either in number of reams or rolls or in weight.

Quality.

Color.

Size of sheet in centimetres or English inches. For rolls, the width of the paper should be given in centimetres or English inches. Fractions are rounded off to one-half of a centimetre or one-quarter of an inch. The longitudinal direction of the fibres in the sheet must be stated if regarded as of importance.

Number of sheets per ream. This is always calculated as 500, if no special number is ordered.

Weight per ream or per roll of fixed length, in kilograms or English pounds, or in grams per square metre.

Folded or flat.

Degree of sizing; unsized, half-sized, completely sized, sized with animal glue or surface sized.

Cut or uncut, smooth on only one side, rough, smooth, calendered, or supercalendered.

Kind of packing and mark.

Price and time of delivery.

Place of delivery, payment of freight charges and insurance.

The seller must immediately acknowledge receipt of an order if accepted. The buyer must make his objections, if any, by return of mail after having received this acknowledgment. The buyer can only object to apparent error in manufacture, if this is not done.

The improvements which the E. B. Eddy Co., Hull, are making on their plant, are progressing satisfactorily. Excavation is going on near Bridge street for a power house which will supply power to the whole works and on Bridge street, at the rear of the paper mill, a large pulp mill is being erected, which is to be equipped with the latest modern machinery. The building is 85 x 135 feet, and everything will be on the one floor. It will not be completed for a year yet. The power house foundation will be on a level with the river below the mills and will generate 60,000 horse power. At present the power is supplied by water power, but this will be done away with when the new power house is in operation.

## New Publications

*The Third Annual Report of the Commission of Conservation*, being the proceedings of the Commission held in Ottawa on Jan. 16th last, is to hand. The Chairman, Hon. Clifford Sifton, departed from the usual custom of himself making a review of all phases of the Commission's work, and asked for such reviews from the Chairmen of the individual branches. These committees reported on Public Health, Lands, Forests, Minerals, Fisheries, Game and Fur-bearing Animals, Waters and Water Powers, Press and Company Operating Organizations. Dr. B. E. Fernow makes some comments on his forest survey of Nova Scotia; Dr. J. W. Robertson on the work of the Committee on Lands; R. H. Campbell on the Rocky Mountains' Forest Reserve; Dr. Robertson on Improving Canadian Agriculture; F. C. Nunick has an Agricultural Survey for 1911; Dr. A. C. Hodgetts an Address on House and Town Planning. The Secretary of the Commission is James White, Ottawa.

\* \* \*

"*Supplement to Annual Sanctuaries in Labrador.*" This is a small pamphlet supplementary to the fine address on this subject by Lieut.-Col. W. Wood, F.R.S.C., before the Second Annual Meeting of the Commission of Conservation. The supplement is an indication of the wide interest and many suggestions aroused by the original address. The gist of the advice given is that the application of Col. Wood's suggestions ought to be extended by including the leasehold system, side by side with the establishment of sanctuaries and the improvement and enforcement of laws for the preservation of wild life.

\* \* \*

*The Testing of Wood Pulp.*—A practical Handbook for the pulp and paper trades, by Sindall & Bacon, published by Marchant, Singer & Co., 47 St. Mary Axe, London, E.C. This book, which fills the demand for a simple handbook on the testing of wood pulp, embodies the results which have been obtained by leading analysts, with descriptions of the methods employed in various countries. It is divided into two sections: (1) The sampling and testing of pulp for

moisture, and (2) testing of pulp for bleaching qualities, while a very useful appendix treats of the chemistry of bleaching. While elementary in character, the book goes quite thoroughly into the subjects treated of. For instance, in the first section are chapters on selection of bales, methods of sampling, measurement of probable errors, apparatus for testing pulp, wood pulp contract, notes of various countries, etc., etc. Under the head of bleaching, qualities of pulp may be mentioned, divisions on mill practice and other conditions which affect bleach consumption, question of a standard color, measurement of color, standard methods of testing, etc. The book has several illustrations and its value is enhanced by a complete index.

\* \* \*

*The Paper Makers' Directory of All Nations.* Published by Dean & Sons, Ltd., 160a Fleet St., London, E.C. Cloth bound, 790 pages, 10s. 6d. net. This well-known directory has been issued for 21 years, and no extended comment is needed therefore. It is divided into three main sections: The first gives full particulars of the paper, pulp and board mills of the United Kingdom, with lists of wholesale stationers and paper merchants, paper agents and mill representatives, dealers in China clay, waste paper, rag and paper stock, manufacturers of cardboard boxes and paper bags. The second, giving details of foreign and colonial paper, pulp and board mills. The third section gives the production of all the world's mills, British, foreign and colonial, classified together in one list. These sections are all arranged alphabetically, and there is an easy system of indexing. Several other features, such as list of export merchant shippers, names of British and foreign trade associations, British trade customs, etc., help to make up a very valuable book of reference.

\* \* \*

*Phillips' Paper Trade Directory of the World*, with which are incorporated Phillips' Directory of Paper Makers of Great Britain and Ireland, and Phillips' Paper Trade Directory of the British Em-

pire, published by S. C. Phillips & Co., 47 Cannon St., London, E.C. The 1912 edition of this highly valuable work of reference to everybody connected with the paper and allied industries has now been issued and is even more complete than usual. Every section of the directory has been thoroughly revised and considerably extended; so much so that the volume includes nearly one hundred pages more than any previous edition. This particularly applies to the directory of the British Paper Mills, Paper Buyers, Merchants, Agents, etc., while the section devoted to the British Paper Box and Bag Making industry has been extended by the addition of nearly twenty pages, making it representative of the entire industry in Great Britain and forming, without doubt, a very complete list of Paper Box and Bag Manufacturers. The lists of colonial and foreign paper mills, pulp mills, paper merchants, and paper buyers generally, have been carefully revised and greatly extended. An indication of this expansion is to be found in the fact that the total number of pulp and paper mills throughout the world, of which particulars are given in the directory, approximates to 4,800, as compared with 4,250 in the previous edition. The lists of water marks have also received important additions, something like 1,000 water marks being given. Altogether the directory contains upwards of 1,000 pages, and the information it embraces occupies some hundred pages more than in the edition of 1911.

---

—The Pulp and Paper Magazine enjoyed a visit a few days ago by Mr. F. W. Vickery, managing director of Vickerys Patents, Ltd, London, Eng., specialists and exclusive makers of machines for handling paper in sheet form.

—Mr. Alex. Annandale, the Scottish paper-maker, who has contributed articles to the Pulp and Paper Magazine, and whose work in connection with Esparto pulp in Italy has been already referred to, reports that satisfactory progress is being made in this work. He sends us some samples of pure Esparto pulp and of paper made from 90 per cent. Esparto and 10 per cent. soda wood pulp, which look to be fine examples of the paper-maker's art.

### THE LATE HUGH J. CHISHOLM.

We regret to have to record the death last month of Hugh J. Chisholm, probably the best known man in the pulp and paper industry on the American continent. During the last two or three years he had retired from active business, though he retained the presidency of the Oxford Paper Co., Rumford Falls, Me. The deceased gentleman was really a Canadian, having been born at Niagara on-the-Lake in 1847. His is one of the outstanding example of great success founded on small beginnings, for he began his business life as a newsboy on the Grand Trunk Railway between Toronto and Detroit. In this he saved enough money to take a course at a business college in Toronto. In 1861 with his brothers he started a firm, which eventually controlled the news business of the Grand Trunk and ultimately covered a much wider field. Chisholm Bros. also originated the transportation publishers business, producing railway and tourists' guides and albums descriptive of routes. He became interested in the pulp and paper industry in 1880, among his early enterprises being the Umbagog Pulp Co., Otis Falls Pulp Co., and Rumford Falls Power Co. He was active in starting the International Paper Co. and was elected president in 1898, retaining that position for five years and afterwards becoming chairman of the Board of Directors. In 1901, he established the Oxford Paper Co., Rumford Falls, Me. The late Mr. Chisholm, besides being a man of wonderful executive gifts, was genial in disposition and his death is universally mourned.

---

The Riordon Pulp & Paper Co., is installing at its Hawkesbury mill two large new digesters, some drying machines, and considerable other equipment, the result of which will ultimately be to increase its total output of sulphite by 40 per cent. The company will also probably develop power on the Rouge River, where it owns water rights. We hear that the company will instal a machine for making fine writings, etc.

## TRADE ENQUIRIES.

The following enquiries affording trade opportunities for Canadian pulp and paper houses have been received by the Department of Trade and Commerce at Ottawa. Further information can be obtained on application to the office of the Pulp and Paper Magazine, or at the Enquiries Branch, Department of Trade and Commerce, Ottawa. Reference should be made to the number in each case:

686. Newspaper.—Canadian manufacturers of newspaper are invited to correspond with leading firm of commission merchants in Cienfuegos, Cuba. Bank references.

724. Paper machine wires.—A Scottish company manufacturing paper machine wires are prepared to offer their agency to some resident Canadian agency firm who are already calling on paper mills in connection with other supplies.

758. Pulp board and leather board.—A South African firm of cardboard box manufacturers desires to be put into communication with manufacturers of pulp board and leather board, suitable for boxes such as laundry boxes, drapers' boxes, bakers' cake boxes, tailors' suit boxes and cigarette boxes. Samples and price lists requested.

778. Printing paper.—An old established and strong firm of importers in Brazil desires to be placed in touch with exporters of printing paper, who may be able to compete with the German and United States mills.

787. Printing paper.—An old established and financially strong importing house desires to enter into correspondence with a Canadian paper mill, capable of supplying the Brazilian market.

806. Printing paper.—An old established and strong firm of importers in Brazil desires to be placed in touch with exporters of printing paper, who may be able to compete with the eGarmn. and United States mills.

809. Printing paper.—A firm of manufacturers' agents desires to enter into communication with exporters of printing paper.

814. Wall paper.—A firm of manufac-

turers' agents in Brazil desires to enter into touch with exporters of wall paper. Forward samples with prices c.i.f. Rio de Janiero.

## NEW INCORPORATIONS.

The MacBride Press, Limited, Brantford, Ont.; capital \$40,000. To acquire the printing, publishing and bookbinding business of the MacBride Press.

\* \* \*

Toronto School Supply Co., Limited, Toronto; capital \$40,000. To manufacture and deal in all kinds of books, stationery, and general school supplies. Geo. Dunham and S. E. Ballard, Toronto.

\* \* \*

Prince Rupert Financiers, Limited, Prince Rupert, B.C., capital \$100,000. To do business as saw mill owners, manufacturers of pulp and paper, etc.

\* \* \*

York Publishing Co., Toronto; capital \$50,000. To do business as publishers and booksellers, make and deal in paper, etc. L. McD. Coulter, Dr. Maek Anderson, and H. B. Anderson, Toronto.

\* \* \*

John Dickinson & Co., Limited, London, Eng., licensed to do business in British Columbia as paper makers and wholesale stationers. F. R. McD. Russell, 837 Hastings street west, Vancouver.

\* \* \*

Franco-Canadian Timber Co., Limited, London, licensed to do business in British Columbia as lumber, pulp, and paper manufacturers. H. E. A. Robertson, 88 Exchange Buildings, Vancouver.

\* \* \*

The Port Nelson Company, Limited, Winnipeg; capital \$1,000,000. To (among several other powers) manufacture lumber, pulp and paper. E. A. Dunfield, student; Harold Dutton, accountant, W. J. Johnston, banker, all of Winnipeg.

\* \* \*

Howard Smith Paper Mills, Limited, Montreal; capital \$1,000,000. To take over the business of Howard Smith Paper Co., and manufacture pulp, pulpwood, paper, etc. J. J. Meagher, W. A. Merrill, of Montreal, and A. H. Duff, and P. W. Peacock, of Westmount.



## Recent Canadian Patents Affecting the Pulp and Paper Industry

No. 139439. Paper Feed Mechanism. Hinde & Dauche Paper Co., assignee of W. F. Harbrecht, both of Sandusky, Ohio. It consists of a strip feeding mechanism having a constant and uniform feed, a rotary cut-off, a mechanism connecting cut-off, including a variable speed transmission, a

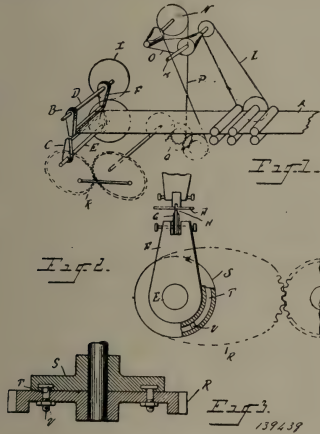

pair of intermeshing elliptical gears having their cycle coincident with that of the cut-off, and means for adjusting said gears to compensate for adjustment in said transmission and to maintain uniform speed of operation of the cut-off.

\* \* \*

No. 139673. Paper Pulp Softening and Crushing Machine. In a softening or crushing apparatus for the manufacture of paper pulp, rollers are arranged in different series and alternately placed one to another. One series is stationarily supported and another series movably supported. There are also of one series to the stationarily supported rollers of another series forming passages or slits between each two rollers, which passages or slits gradually decrease in height or section from the uppermost to the lowermost pair of rollers from about the half thickness of

the material to be softened or crushed down to the complete contact between the lowermost pair of rollers between which the material under treatment supplied to the upper-

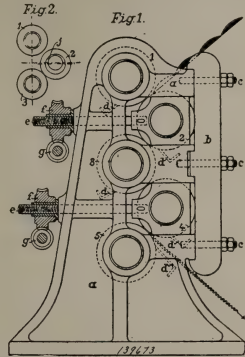

most pair of rollers in a direction at right angles to the run of its fibres. This leaves the machine in the shape of a stretched half stuff fleece of tinder-like softness and without any division of separate fibres.

Last month there was a break in the big flume at J. R. Booth's mills at Ottawa, and the lumber, pulp, paper and cardboard mills had to close down for two or three days. The veteran Mr. Booth himself helped superintend the work of repairing the break.

\* \* \*

The Ontario Pulp and Paper Co. have started operations at the Sturgeon Falls mill. The sulphite mill has been working to full capacity for some time past. The sulphite is mainly used by the neighboring plant at Spanish River, while the balance is shipped to Wisconsin and other points in the Middle West. The combined output of the two mills brings it up to the second largest producer in Canada. Six additional grinders are shortly to be installed at the Spanish River mill.



## Pulp and Paper News

We hear that the St. Lawrence Paper Co. are likely to instal another machine in the near future.

\* \* \*

The Campbell Lumber Co., Weymouth, N.S., hopes to have its rebuilt pulp mill in operation by the middle of next month.

\* \* \*

There was recently unveiled in Paris a monument to the memory of Nicholas L. Robert, the inventor of the first paper machine.

\* \* \*

Mr. McLean, lumber merchant, Bathurst, N.B., has a project for developing power from Nepisiquil Falls, and establishing a 100-ton paper mill.

\* \* \*

The Laurentide Paper Co. which already owns considerable timber limits on the Upper St. Lawrence, has just acquired about 398 miles additional from Calvin Power Co.

\* \* \*

J. H. P. Gould, of Lyons Falls, N. Y., is interested in a project to establish a paper mill on Cartier River, near Quebec. A timber area of 160,000 acres has been purchased.

\* \* \*

Mr. John R. Barber, the veteran paper maker, who has recently disposed of several of his trade interests, is on a well-earned rest, touring Great Britain and the Continent.

\* \* \*

The North Railway Co. has been formed with a capitalization of \$10,000,000 for the purpose of building a 500-mile line from Montreal to Port Nelson, traversing very rich timber and pulpwood areas.

\* \* \*

The buildings of the Interlake Tissue mills at Merriton are making good progress. Provided the machinery is to hand on time, there is every prospect of the first sheet being made in October.

\* \* \*

Lancashire manufacturers of wallpaper are desirous of obtaining from Canada ground mica suitable for imparting a satin finish on wallpaper, such as secured

largely at present from the United States.

\* \* \*

The Quebec Bank has gained its suit in the Ontario Court of Appeals against the late Imperial Paper Mills, regarding the possession of logs in the river near Sturgeon Falls. It will probably go to a still higher court.

\* \* \*

We understand that Mackenzie & Mann, of the Candian Northern Railroad, are making plans for the development of 25,000 or 30,000 h.p. at Cameron's Falls on the Nepigon River, Ontario, and that after a while they will erect a pulp and paper mill.

\* \* \*

Messrs. Chambers & Simpson, Toronto, secured the order for the 1,500 lbs. beaters for the new Crabtree mills. The beaters will have iron troughs and are so dished that the "turning" will be absolutely positive. Their principals, Messrs. Bertrams, Limited, have the paper machines on hand for the same mills.

\* \* \*

✓ The Lake Superior Paper Co.'s new newsprint mill at Sult Ste. Marie, Ont., made its initial run recently, which proved quite successful. Orders are coming in satisfactorily. Two 154 in. machines are already installed, while two more are being built. The total output will be in the neighborhood of 200 tons daily.

\* \* \*

✓ The recently incorporated Howard Smith Paper Mills, Ltd., of Montreal, will erect a factory at Beauharnois, Que., for the manufacture of high grades of book paper, specializing on loft dried. An 84-inch machine will be put in to run on fine writing and bonds. The plant will also be equipped with a Margalt suction roll. The first section of driers will be fourteen in number in one tier, after which will be placed a sizer, followed by five driers and a nine-roll calender. H. C. Courtney, who has been acting as superintendent of the Toronto Paper Manufacturing Co.'s mill at Cornwall, will be general manager.

The British Canadian Industrial Co. will build a 100-ton pulp mill near St. Felician, Que. They own about 300 square miles of timber land on the Salmon River, with a valuable waterpower. J. L. Bates is president, while A. N. Cheney and S. A. Huntington, of Ottawa, are also interested. The company hopes ultimately to make paper as well.

\* \* \*

An exhibit of unusual interest to paper-makers at the forthcoming Canadian National Exhibition, will be Dr. Wurster's Kneader. This machine will be exhibited by Bertrams, Limited, of Sciennes, Edinburgh, in operation, and we are given to understand that tests may be arranged whereby waste paper will be treated and returned in a reduced state to any mill consigning sample to Exhibition.

\* \* \*

While fortunately the pulp mill itself at Chicoutimi escaped injury in the recent fire, the town suffered severely and many of the mill hands also lost their homes. A very pleasant impression was created by the good feeling of paper manufacturers in Great Britain, who, at the instance of Mr. F. E. R. Becker and the Papermakers' Association, promptly sent a large donation to the local relief committee.

\* \* \*

The Roberval Paper Co., is making progress on its plans for the erection of a 60-ton pulp mill at a cost of over \$600,000. It owns large forest areas in Lake St. John District. Eventually a paper mill will be built as well. The president of the company is M. A. du Tremblay, who has long been identified with the lumber business at Roberval, Que., while the vice-president is M. G. des Trois Maisons. These gentlemen have just returned from a visit to Europe investigating machinery.

\* \* \*

According to latest reports negotiations have been successfully completed for the merger of the two power companies at Grand Falls. Sir W. Van Horne, Hon. W. Pugsley, Col. H. H. McLean, and H. A. Rowell, K.C., St. John, are among those chiefly interested. At Grand Falls mills are to be erected and the water power

there is to be harnessed and doubtlessly will eventually be utilized for other purposes than the running of the plant which the company will erect. An outlay it is anticipated will be made to the amount of at least \$6,500,000, and it may reach \$8,000,000.

#### FLAT STRAINERS OR ROTARY.

A good many prefer rotary strainers before the usual form of flat ones, because the former operate continuously. The flat strainers, on the other hand, require to be washed out from time to time, which causes not only a waste of stuff, but loss of time for the machine. The stopping and starting of the machine also involves the production of a large amount of broke. But although the rotary strainer avoids this difficulty, its running is accompanied by a continuous loss of good fibres, which are washed away along with the knots and tangles by the action of the cleaning sprays. wastes the most stuff, but the writer prefers the rotary, because the paper machine does not have to be stopped so frequently. With any type of strainer it is most desirable that the stuff should be diluted as largely as possible before it arrives at the strainer. The more dilute the pulp the better the strainer works; there is less tendency to form tangles, the pulp becomes more uniformly distributed and the paper is improved both in look-through and surface.

So important is this question of dilution that in certain cases it is profitable to dilute the pulp for passing over the sand tables and strainers, and then to take out some of the water by means of a drum washer situated between the strainer and the paper machine. Such an arrangement is particularly useful in making cardboards or when working "greasy" stuff. Large dilution is the only cure for a wild and lumpy look-through.

All the varieties of the two main types of strainer may be relied upon for efficient work. Other things being equal, we would

prefer a pattern which works with the least noise and gives minimum wear of the moving parts.

## Canadian Pulp and Paper Markets

Toronto, Aug. 12, 1912.

The heavy demand for newsprint continues unabated at the stiff prices prevailing. Orders from across the border keep up well, while those from the Western provinces show a constant tendency to increase. So far as we have heard, no difficulty has been experienced in disposing of all the product of new and increased capacity mills, which has come on the market.

The book and writing mills are experiencing a fairly busy time. Increased prices are looked for shortly. This will have more particular reference to the better grades of book papers, as in the cheaper qualities a slight advance was made recently.

Wrappings and manilas are moving pretty well at the advanced range of values. There is a scarcity in some lines, such as butchers' greys and some lines of manilas. Bags are firm.

Water conditions in most parts of Canada have been good and large quantities of ground wood have been made and piled. However, there has been quite a movement across the line, as a result of low water in the Eastern States. The precipitation in New York State for June and July was only about half normal, though in the Western States it was fully up to average. Ontario and Quebec makers of mechanical pulp have held out for good prices all along in anticipation of the keener demand which has now materialized. For sulphite, both bleached and unbleached, prices have been extremely stiff, as a result of scarcity and heavy demand.

We quote:—

We quote:—

News print, rolled, \$2.00.

News print, sheets, \$2.25.

Book papers—Carload lots No. 3, 4¾c.

Book papers—Broken lots No. 3, 4½ to 4¾ cents.

Carload lots No. 2, 4¾c.

Manila B, 3½c.

(Continued on page xxviii.)



### TIMBER FOR SALE

TENDERS will be received up to and including the first day of October, 1912, for the right to cut white and red pine and spruce, on two timber berths on the upper waters of the Jocko River east of the townships of Garrow and Lockhart, in the District of Nipissing, Province of Ontario, the berths being designated "Jocko No. I" and "Jocko No. II," each containing twenty-five square miles more or less.

For maps and conditions of sale apply to the undersigned.

**W. H. HEARST,**

Minister of Lands, Forests and Mines.  
Toronto, July 17th, 1912.



### TENDERS FOR PULPWOOD LIMIT.

TENDERS will be received by the undersigned up to and including the 15th day of August next, for the right to cut pulpwood on a certain area situated on the Abitibi Lakes and River tributary to the Grand Trunk Pacific Railway, and the Temiskaming and Northern Ontario Railway, in the District of Temiskaming.

Tenderers shall state the amount they are prepared to pay as a bonus in addition to dues of 40 cents per cord for spruce, and 20 cents per cord for other pulpwoods, or such other rates as may from time to time be fixed by the Lieutenant-Governor in Council, for the right to operate a pulp mill and a paper mill on or near the area referred to.

Such tenderers shall be required to erect a mill or mills on or near the territory and to manufacture the wood into pulp and paper in the Province of Ontario—the paper mill to be erected when directed by the Minister of Lands, Forests and Mines.

Parties making tender will be required to deposit with their tender a marked cheque payable to the Honourable the Treasurer of the Province of Ontario for ten per cent. of the amount of their tender, to be forfeited in the event of their not entering into agreement to carry out conditions, etc.

The highest or any tender not necessarily accepted.

For particulars as to description of territory, capital to be invested, etc., apply to the undersigned.

**W. H. HEARST,**

Minister of Lands, Forests and Mines.  
Toronto, Ontario, May 15th, 1912.

# EMERSON MANUFACTURING CO. LAWRENCE, MASS.

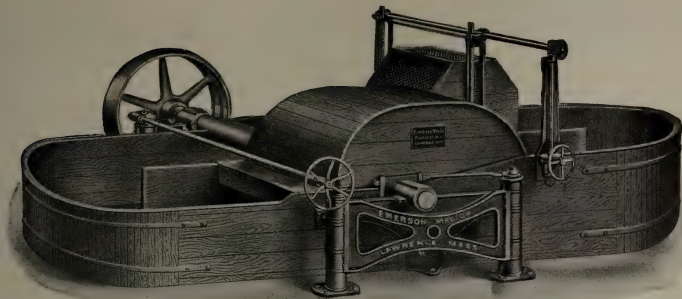

Beating and Washing Engines  
Paper Mill Machinery

**THE UNITED WIRE WORKS LTD,**  
EDINBURGH, GLASGOW & NEWCASTLE-ON-TYNE  
**FOURDRINIER WIRES, CYLINDER WIRES,**  
AND WIRE CLOTH OF ALL KINDS.

AGENTS, ARTHUR P. TIPPET & CO 8 PLACE ROYALE MONTREAL.  
WIRES HELD IN STOCK AT MONTREAL FOR PROMPT DELIVERY.

## ARTHUR P. TIPPET & CO.

AGENTS AND IMPORTERS  
PAPER MILL SUPPLIES  
SULPHUR FELTS

SAL AMMONIAC, BORAX, SANTITIE, ETC.  
MONTREAL, TORONTO.



IMPROVED WARREN PATENT

# Double Drum Winder

With Slitter Attachment Combined

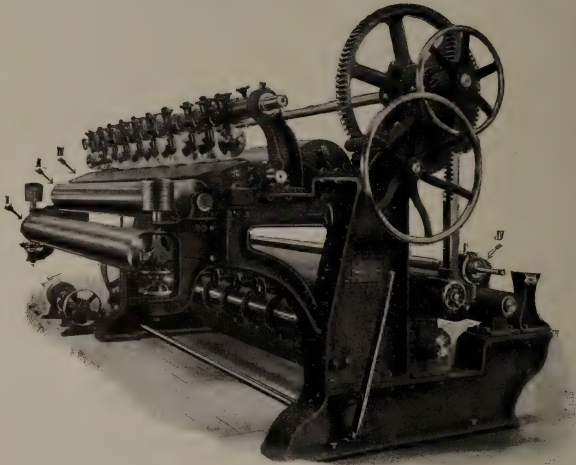

REAR VIEW SHOWING SLITTERS.

REFERENCE :

- I—8-inch Brass Spring Coll.
- II—8-inch Brass Carry Roll
- III—8-inch Adjustable Draw Board.
- IV—Adjustable Core Shaft Box.

Compare this Winder with Others

BUILT BY

## Ticonderoga Machine Works

TICONDEROGA, N.Y., U.S.A.



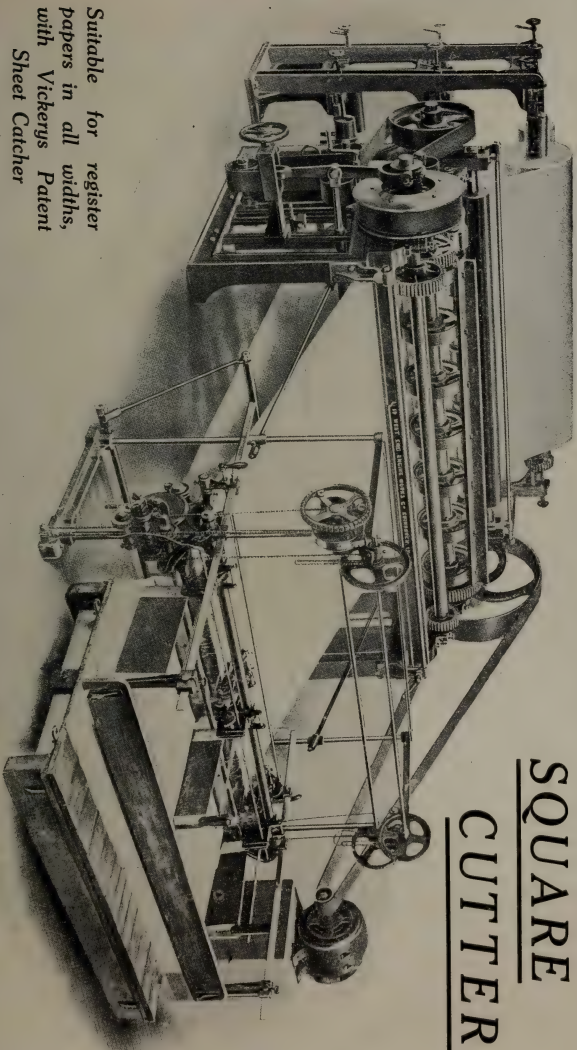

# SQUARE CUTTER

Suitable for register  
papers in all widths,  
with Vickers Patent  
Sheet Catcher

MADE BY

THE WEST END ENGINE WORKS CO.

PAPER MAKERS' ENGINEERS

EDINBURGH  
SCOTLAND

Broken lots No. 2, 5½ to 5¾c.  
 Carload lots No. 1, 5½ to 6¼c.  
 Broken lots No. 1, 6 to 6¾c.

**Wrappings—**

Manila B, 3¾c.  
 Fibre, 3¾ to 4c.  
 No. 2 Manila, 3½c.  
 No. 1 Manila, 3½ to 4¼c.  
 Kraft, 5c.

**Pulp—**

Ground wood (at mill), \$16 to \$17.  
 Sulphite (bleached), \$58 to \$63.  
 Sulphite (unbleached), \$46 to \$47.  
 Waste Papers, per 100 lbs., f.o.b. Toronto—  
 No. 1 Hard White Shavings, \$1.65 to \$1.75.  
 No. 2 Hard White Shavings, .... to ....  
 White Envelope Cuttings, \$1.65 to \$1.75.  
 No. 1 Soft White Shavings, \$1.25.  
 No. 3 Soft White Shaving, \$1.30.  
 No. 3 Soft White Shavings, \$1.10.  
 White Blanks, \$1.10.  
 Mixed Shavings, 35 to 37½c.  
 Heavy Ledger, \$1.27½ to \$1.40.  
 Ordinary Ledger, \$1.00 to \$1.10.  
 No. 1 Flat Books, 80 to 90c.  
 No. 1 Book Stock, 75c to 80c.  
 No. 2 Book Stock, 39½ to 40c.  
 No. 1 Manila Envelope Cuttings, \$1.20.  
 No. 1 Print Manilas, 65c.  
 Railway Manilas, 25c.  
 Folded News Overissues, 45c.  
 Folded News, 45c.  
 Crushed News, ..  
 No. 1 Mixed Papers 25c. to 35c.  
 Rags (New and Old), per 100 lbs.—  
 1st Old White Cottons, \$2.00.  
 2nd Old White Cottons, ....  
 Roofing Stock—  
 Flock Satinets, 75 to 80c.  
 Ordinary, 55 to 60c.  
 Tailor Sweepings, 55 to 57½c.  
 No. 1 White Shirt Cutings, \$4.75 to \$5.00.  
 No. 2 White Shirt Cutings, .... to .....  
 Fancy Sheet Cuttings, \$3.65 to \$3.75.  
 New Blue Prints, ... to ...  
 New Blue Overalls, \$3.42½ to \$3.65.

New Black Overalls, \$1.60 to \$1.70.  
 New Black Linings, \$1.60 to \$1.75.  
 New Unbleached Cottons .... to .....  
 Bleached and Unbleached Shoe Clips,  
 New Light Flannelettes, \$3.75 to \$4.40.  
 New Light Shirt Cuttings, \$3.90 to \$4.35.  
 Light and Dark Cords, .... to .....

**SCANDINAVIAN MARKETS.**

C. E. Sontum, Canadian Trade Commissioner in Norway, reports to Ottawa that the prospects for the Norwegian timber owners to get their timber floated down to the mills are not bright. Last summer was an exceedingly dry one, and caused large delays in floating lumber to such an extent that most of the Norwegian sawmills and pulp mills had to work with considerably reduced forces. The tendency in mechanical wood pulp is for an advance. Selling for next year has commenced, and buyers seem to think it good policy to cover themselves, but not all pulp mills are inclined to sell at the moderate prices which can be obtained for forward delivery.

**BRITISH MARKETS.**

London, July 29, 1912.

Sales of mechanical pulp are moving slowly, and prices are easy; for soda or sulphite pulps there is a good demand at unchanged prices.

Rags are in fair demand and stocks are limited.

For chemicals there is a good demand. Bleaching powder is in short supply. Ammonia is firm. Soda is unchanged.

John Gilmour, of Gilmour & Hughson, Ottawa, who own large pulpwood limits on Gatineau and Lievre Rivers, died recently. He was well known among lumber and paper manufacturers.

**The PULP & PAPER TRADING CO.**

TEMPLE COURT BUILDING, NEW YORK CITY.

DEALERS IN

**Paper and Pulp of All Kinds.**

Prices and Samples on Application.

Telephone: 2726 BROAD.

Cable Address: "LAGERLÖF NEWYORK."

# Scandinavian-American Trading Company,

PRODUCE EXCHANGE BUILDING, NEW YORK,

IMPORTERS AND EXPORTERS OF

FOREIGN AND DOMESTIC

# WOOD PULP

OF ALL KINDS

AND

# PAPER MILL SUPPLIES.

HANS LAGERLÖF, PRES.

ALL KINDS OF  
 Machines for Paper, Pasteboard,  
 Cardboard, Cellulose  
 and Pulp Mills

Paper Machines      Calenders  
 Winders              Calender Roll Lathes  
 Filters (Füllner's Construction)  
 Cutters              Cone Refiners  
 High Power Grinders   Patent Beaters  
 Edge Runners

FIRST-CLASS REFERENCES

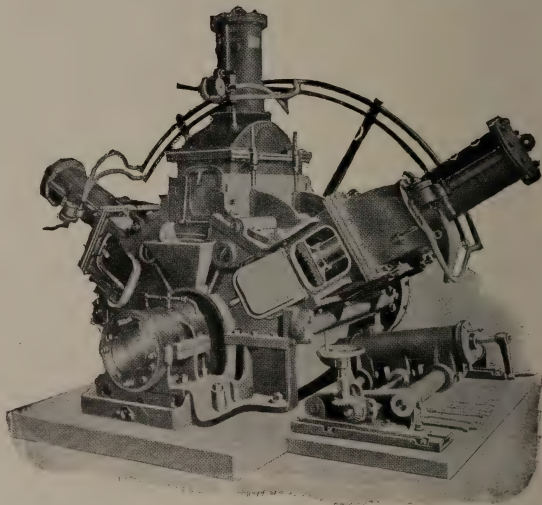

MOST MODERN CONSTRUCTIONS

Founded 1854

**H. FÜLLNER**

WARMBRÜNN  
SILESIA  
GERMANY

Prizes won at all exhibitions where machines have been shown.  
 Turin 1911 "Grand Prize." Paris 1900 "Grand Prix" und "Kreuz der  
 Ehrenlegion." Leipzig 1897 "Gold Medaille." Paris 1907 "Grand Prix."

# CLASSIFIED ADVERTISERS' INDEX

If you fail to find what you want in these columns, write us and the desired information will be gladly supplied

## Architects and Engineers

Ambursen Hydraulic Con. Co.  
T. Linsey Crossley  
J. A. DeCew  
Eaton & Brownell  
Geo. F. Hardy  
Herbert S. Kimball  
International Process Co.  
Arthur D. Little, Inc.  
R. S. Lea & H. S. Ferguson  
Lyford, Clark & Lyford  
H. B. Prather  
Chas. B. Pride  
T. Pringle & Son  
Stebbins Eng. & Mfg. Co.  
R. O. and W. G. Sweezy  
Jos. H. Wallace & Co.

## Barkers.

Carthage Machine Co.  
Green Bay Barker Co.  
Jenckes Mach. Co.  
Waterous Engine Works.

## Beaters.

Dillon Mach. Co.  
Emerson Mfg. Co.  
H. Fullner  
Holyoke Mach. Co.  
E. D. Jones & Sons Co.  
Valley Iron Works  
Waterous Engine Works

## Beater Rolls.

J. A. DeCew  
J. Marx & Co.

## Belting.

Dom. Belting Co.  
F. Reddaway & Co.  
Sadler & Haworth

## Bleaching Powders.

Brunner, Mond & Co.  
Hooker Electro-Chemical Co.  
Winn & Holland

## Boilers.

John McDougall Caledonian Iron Works

## Brass Wire Cloth, Fourdrinier Wires.

Geo. Christie, Ltd.  
Herman Finckh  
C. H. Johnson & Sons, Ltd.  
Jas. Taylor  
A. P. Tippet & Co.  
United Wire Works  
P. P. Westbye

## Camel Hair Belting.

F. Reddaway & Co.

## Calender Rolls.

Farrel Foundry & Mach. Co.

## Chemicals, Colors, Etc.

Brunner, Mond & Co.  
Gewerkschaft Sachtleben  
A. Klipstein & Co.  
Hooker Electrochemical Co.  
Paper Makers' Chemical Co.  
A. P. Tippet & Co.  
United Alkali Co.  
Wilson-Paterson Co.  
Winn & Holland

## China Clay.

China Clay Co.  
A. Klipstein & Co.  
C. A. Meincke & Co.  
Paper Makers' Chem. Co.  
Wilson-Paterson Co.

## Chippers.

Carthage Machine Co.

## Conveying Machinery.

H. W. Caldwell & Son Co.  
M. Garland Co.  
Jeffrey Mfg. Co.

## Digester Lining.

Panzl Digester Lining Co.  
Preston's Digester Lining Co.  
Stebbins Eng. & Mfg. Co.

## Digesters.

Schaeffer & Budenberg Mfg. Co.  
Swenson Evaporator Co.

## Drainer Bottoms.

Samuel Snell Co.

## Evaporators.

Ernest Scott & Co.  
Swenson Evaporator Co.  
Zaremba Company.

## Exporters.

Parsons Trading Co.

## Felts.

F. Bredt & Co.  
Dallyn, Jardine & Co.  
Hamelin & Ayers Co.  
C. H. Johnson & Sons, Ltd.  
Penman's, Ltd.  
Joseph Porritt & Sons.  
J. H. Spencer & Sons.  
A. P. Tippet & Co.

## Fourdriniers Wires.

(See Brass Wire Cloth.)

## Grinders.

Carthage Machine Co.  
H. Fullner.  
Glens Falls Mach. Co.

Holyoke Machine Co.  
Jenckes Machine Co.  
J. M. Voith  
Waterous Engine Works

## Knives.

Crookes, Roberts & Co.  
Peter Hay Knife Co.  
A. P. Tippet & Co.

## Paper Mills.

Canada Coating Mills.  
Canada Paper Co.  
New Brunswick P. & P. Co.  
Rolland Paper Co.  
Riordon Paper Co.

## Paper Presses.

Can. Boomer & Boschert Press Co.

## Paper and Pulp Dealers.

Atterbury Bros.  
Albert E. Mallandain.  
Castle, Gotthel & Overton  
Churchill & Sim  
Howell Co.  
International Process Co.  
Parsons Trading Co.  
Pulp and Paper Trading Co.

## Paper Stock, Rags, Etc.

Atterbury Bros., Inc.  
J. Christie Co.  
R. Hough  
The Howell Co.  
E. Pullan  
J. R. Walker & Co.

## Paper and Pulp Mill Machinery.

Appleton Machine Co.  
Beloit Iron Works  
Bentley & Jackson  
James Bertram & Son, Ltd.  
Bertram's, Limited  
The Black-Clawson Co.  
Canadian Boving Co.  
Carthage Machine Co.  
Chambers & Simpson  
Dillon Machine Co.  
Emerson Mfg. Co.  
Farrel Foundry & Machinery Co.  
H. Fullner.  
Julius Fischer  
Glens Falls Machine Wks.  
Green Bay Barker Co.  
Harmon Machine Co.  
J. H. Horne & Sons Co.  
Holyoke Machine Co.  
Jenckes Machine Co.  
E. D. Jones & Sons Co.  
C. H. Johnson & Sons, Ltd.  
Marx, J. & Co.  
Jas. Milne & Sons  
Moore & White Co.



B. F. Perkins & Son  
Rice, Barton & Fales  
Ryther & Pringle  
Sandy Hill Iron & Brass  
Works

Ernest Scott & Co.  
Sheldons, Ltd.  
Sherbrooke Machinery  
Co., Ltd.

S. Morgan Smith Co.  
Stebbins Engineering &  
Mfg. Co.

H. F. Storrer  
Swenson Evaporator Co.  
Ticonderoga Machine  
Works

Valley Iron Works  
J. M. Voith

Charles Walmsley & Co.  
Chr. Wandel  
Wandel Screen Mfg. Co.  
Waterous Engine Works  
Co., Ltd.

P. P. Westbye  
West End Engine Wks. Co  
Zaremba Co.

**Pipes (Wooden).**

National Pipe & Foundry  
Co., Ltd.

**Pumps.**

Can. Boving Co.  
Carthage Machine Co.  
Dillon Machine Co.  
Lawrence Machine Co.  
Lawrence Pump & En-  
gine Co.

John McDougall Caledon-  
ian Iron Works.  
Smart-Turner Mach. Co.

**Rosin Size.**

Paper Makers Chemical  
Co.  
Vera Chemical Co.  
Wilson-Paterson Co.

**Scales.**

Alfred H. Mardon

**Screen Plates.**

Union Screen Plate Co. of  
Canada

**Screens.**

Glen Falls Machine Wks.  
Harmon Machine Co.  
Sherbrooke Machinery Co.  
J. M. Voith.  
Chr. Wandel  
Wandel Screen Mfg. Co.  
Waterous Engine Works  
P. P. Westbye

**Slitters and Re-Winders.**

H. Fullner  
Moore & White Co.  
Ticonderoga Mach. Co.

**Sulphur.**

Union Sulphur Co.

**Talc.**

Geo. H. Gillespie Co.

**Tanks.**

John McDougall Caledon-  
ian Iron Works

**Transmission Machinery.**

H. W. Caldwell & Son Co.  
Jones & Glassco  
Dodge Manufacturing Co.

**Travelling Cranes.**

Hugh R. Blethen  
Northern Crane Co.  
Smart-Turner Mach. Co.

**Turbines.**

J. M. Voith  
S. Morgan Smith Co.

**Water Wheels.**

John McDougall Caledon-  
ian Iron Works  
Holyoke Machine Co.

**Wire Cloth for Paper Ma-  
chines.**

Scottish Wire Cloth Co.,  
Ltd.

**Wood Pulp Agents.**

Castle, Gottheil & Over-  
ton  
Churchill & Sim  
Parsons Trading Co.  
Scandinavian Amer. Trad-  
ing Co.

# CALDWELL HELICOID

THE SCREW CONVEYOR IN ITS MOST PERFECT FORM IS *HELICOID*. We are the only people who actually *roll a continuous conveyor flight* by any process. Others roll or press short flights which have to be lapped and riveted together and pinned to the pipe at every turn. A screw conveyor is economical and requires little room, and while you are buying, buy the best - buy *Helicoid* with larger shaft, greater capacity and increased durability.



**ELEVATING, CONVEYING AND POWER-TRANSMITTING MACHINERY**

SEND FOR CATALOG NO. 34

**H. W. CALDWELL & SON CO.**

17TH STREET AND WESTERN AVENUE, CHICAGO

NEW YORK - 50 Church Street

# J. H. Horne & Sons

COMPANY

Lawrence - - - Mass.

---

---

MANUFACTURERS OF

## PAPER MILL MACHINERY

---

---

Fourdriniers  
Cylinders and  
Wet Machines

Improved Horne Engines

Horne Jordan Engines  
Double Bevelled Roll Bars  
Horne Friction Cullers  
Barbed Jordan Bars

SEND FOR CATALOGUE

# Fans for the Paper Mill

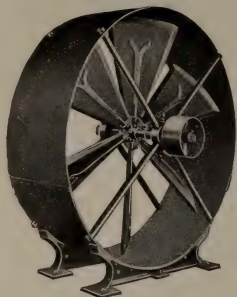

---

We make a Specialty of Ventilating and Exhaust Fans for all kinds of Paper Mill Work. Keep a copy of our No. 85 Catalog in your files for ready reference

---

**B. F. PERKINS & SON, Inc.**

HOLYOKE - MASS.

**FROZEN PULP AND DRY PULP  
IN A**

## Ryther Shredder

Is shredded at the rate of 5 tons per hour. 17 to 25 H. P. required. The above figures are *dry weight* and absolutely guaranteed.

RELIEVE YOUR BEATERS and INCREASE QUALITY and PRODUCTION. Write for full Particulars.

---

**Ryther & Pringle Company**  
Carthage, N.Y.

# BLAKE SIMPLEX PUMPS

*FOR BOILER FEED AND PRESSURE SERVICE*

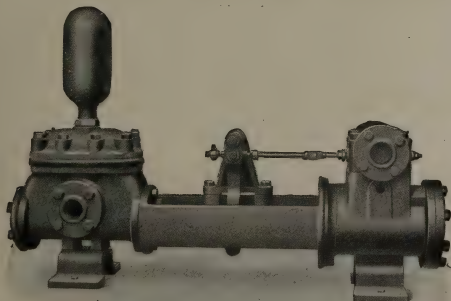

A 250 lb. PRESSURE PUMP  
————— FOR —————  
A 150 lb. PRESSURE PRICE

---

**THE JOHN M<sup>C</sup>DOUGALL  
CALEDONIAN IRON WORKS CO.  
LIMITED**

**WORKS—WILLIAM AND SEIGNEURS STREETS, MONTREAL**

Manufacturers of Boilers, Castings, Condensers, Elevators, Engines, Filters, Forgings, Hydraulic Machinery, Pulleys, Pumps, Centrifugal and Reciprocating, Steam Turbines, Shafting, Tanks, Water Wheels, Water Works Plants.

**PRESTON'S**

# Lining for Sulphite Digesters

*TOTAL THICKNESS ONLY 2¼ TO 2½ INCHES*

Resists the action of the acid and ensures absolute protection to the Digester Plates.

Great durability, therefore large saving in upkeep and repairs.

Larger internal space and increased production on account of the small thickness occupied.

Extensively adopted by Scandinavian and Continental Mills.

Over 200 Digester Linings in work and on order.

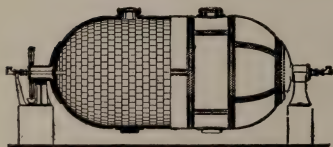
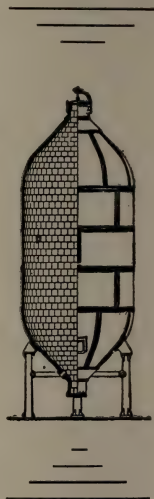

Telegraphic Address :

**"PRESTONS, RADCLIFFE."**

CODE USED A. B. C., 4TH & 5TH EDITION.

*Full Particulars and Prices on application to SOLE MANUFACTURERS*

## PRESTON'S DIGESTER LINING CO., LIMITED

RADCLIFFE, near Manchester, Eng.



---

---

FARREL FOUNDRY AND MACHINE  
COMPANY

ANSONIA, CONN., - - U. S. A.

Largest Manufacturers in the world of

**CHILLED ROLLS**

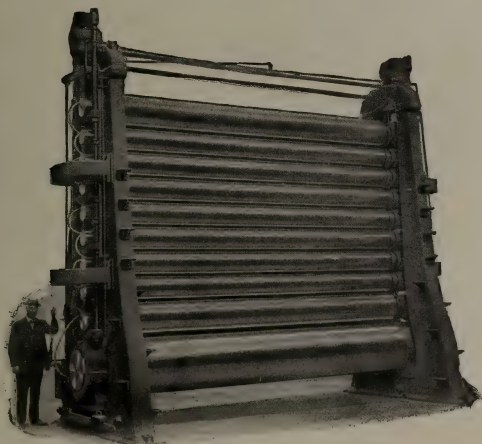

**CALENDERS**

*WITH PATENT HYDRAULIC LIFT*

**ROLL GRINDING MACHINES**

---

---

*Would YOU like to enlarge your Business and find new Customers in all parts of the world? If so, ADVERTISE in*

# “THE PAPER-MAKER AND BRITISH PAPER TRADE JOURNAL.”

THE LEADING AND MOST POPULAR TRADE ORGAN.

**THE ADVERTISER IS GOOD FOR THE READER**

We recently received the following letter:—

“We have hesitated over the matter, as we are at present so busy as to regard further advertising as almost superfluous.

“On the whole, however, we find it pays us better to have to refuse orders than to hunt after them, and will ask you therefore to insert our advertisement on same terms as last.

“We enclose herewith amended matter for advertisement, and shall be glad to have proof of same at your early convenience.”

We are constantly in the receipt of gratifying letters relative to the usefulness of our Journal, and we have pleasure in printing the following:

“Gentlemen,

We beg to advise that we have not as yet received the June number of ‘THE PAPER-MAKER AND BRITISH PAPER TRADE JOURNAL.’

We like the publication so well that we should be very sorry indeed to miss a copy of it.

Thanking you in advance for your kind attention,

We are, dear Sirs, yours very truly,  
F. R. KEYES & SON.  
20 Broad Street, New York.”

## S. C. PHILLIPS & Co.'s STANDARD PUBLICATIONS

### The Paper-Maker

AND BRITISH PAPER TRADE JOURNAL.

Published on the 1st of each month. Price 1s., by post 1s. 6d. Annual Subscription 12s. 6d. post free.

**The Stationery World,  
Printing and Allied Trades,  
AND FANCY GOODS REVIEW.**

Published on the 25th of each month. Price 6d. by post 7½d. Annual Subscription 5s. post free.

Chief Offices:

47 CANNON STREET, LONDON, E.C. (ENGLAND).

### The Paper Box and Bag Maker.

Published on the 19th of each month. Price 6d., by post 7½d. Annual Subscription 6s. 6d. post free.

**Phillips' Paper Trade Directory  
of the World.**

15s. 6d., post free to all countries.

NEW EDITION FOR 1911 NOW READY.

Specimen Copies and Advertisement Rates  
FREE OF APPLICATION.

# PAPER and CLOTH Specialties

*For Rent and Club Cards, Pattern Cards, Map Printing, Label Printing, Envelopes, etc., etc.*

Cloth Lined Papers. Cloth Centred Papers and Boards. Cloth Lined, Chromo and Enamel. Cloth Lined Boards and Cards (surfaced and enamelled). Cloth Centred Boards (surfaced and enamelled). Manilla Surfaced Boards and Cards.

**Also Enamelled Blotting. Art Papers. Paste Boards. Chromo and Surface Papers**

Customers' requirements in specialties are carefully considered and experiments conducted if necessary.

---

## ALBERT E. MALLANDAIN

OFFICES : 51 Cheapside  
London, E.C.

MANUFACTURER

MILLS: Park Royal  
Willesden, London, N.W.

## E. H. WILKINSON

Telephone Building  
82 Adelaide Street West  
Toronto

*Sole Agent for Canada*

Telephone Main 1716  
Cable Address : *Faultless*

# HERMANN FINCKH

REUTLINGEN

*Established 1879*

GERMANY

---

# FOURDRINIER WIRES

---

## SULPHITE - MACHINE WIRES CYLINDER WIRES

---

**P. P. WESTBYE, - Peterborough, Ontario**

*Sole Agent for Canada*

## WANT AND FOR SALE ADVERTISEMENTS

**PULP MILL CHEMIST** with twelve years' experience in Sulphite (Bleached and Unbleached), wants similar position, good draughtsman. Apply Box 30, Pulp and Paper Magazine.

**UNDER MANAGER.**—Young man, 14 years' practical experience in English mill making long elephants, news, all-wood printings, cream laids, etc. Experienced mill chemist—testing of papers, fibres, etc. Highest references. Address H. C., c/o Pulp and Paper Magazine.

**WANTED IMMEDIATELY.**—Master mechanic, machinists, millwrights, and pipefitters for Canadian soda, pulp and paper mill now under construction. Only experienced men need apply. State wage and give references. Apply Box D, Pulp and Paper Magazine.

**WANTED.**—Manager for paper mill on Pacific Coast, making wrapping, sheathing and building paper and box board. Must have practical and business experience and be capable of taking full charge of operations. Apply in confidence giving full particulars of experience, with references, and stating salary required.—Box No. 33, Pulp & Paper Magazine.

### FOR SALE.

**BELTING.**—1,000,000 ft. New Leather Rubber and Cotton Belting; 500,000 feet Iron Pipe; large stock of Pulleys, Shaftings, Hangers, Saws, Wire Fencing, Roofing, Rails, etc. Catalogue on request. Price 25 to 75% cheaper than elsewhere. The Imperial Waste and Metal Co., 105 Queen St., Montreal, Que.

**FOR SALE.**—Special Second-hand cylinder mould, 48-in., diameter 84-in. face. Good as new. Can be used as Filter. For particulars, etc., address Box 32, Pulp and Paper Magazine.

As we are using all our Water Power at our Pulp Mill for electricity, we are disposing of the Pulp Mill Machinery—including Millard Patent Grinders which were in use only a few months and are absolutely as good as new, also Wet Machines, Barkers, Screens, Pumps, Piping, Shafting, Stones, etc., etc., all in good condition. Full information will be given upon application.

Apply Box "A,"

Pulp and Paper Magazine.

**THE PAPERMAKERS' POCKET BOOK.**—By James Beveridge—Specially compiled for Paper Mill Operatives, Engineers, Chemists and Officials. Price \$3.50. Biggar-Wilson, Ltd., Toronto.

**The Canadian Pulp and Paper Directory for 1912, is now ready. Price \$3.00.**

**BIGGAR-WILSON, LTD. - Publishers**  
CONFEDERATION LIFE BLDG. - - - TORONTO

SCOTT'S IMPROVED RECOVERY SYSTEMS  
FOR  
**SODA, SULPHATE & SULPHITE**

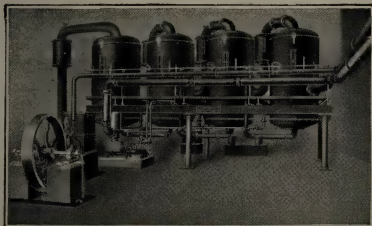

Spent Liquors give the  
MAXIMUM ECONOMY  
AND EFFICIENCY

The PRINCIPLE,  
The DESIGN,  
The CONSTRUCTION,  
The OPERATION,  
The RESULT,

**Is RIGHT**

Complete installations made by "THE FIRM WITH THE EXPERIENCE."

**ERNEST SCOTT & CO.** Manufacturing  
Engineers

FALL RIVER, MASS. and MONTREAL, P.Q.

SODA or SULPHATE  
**LAP-WELDED  
DIGESTERS**

Swenson Multiple Effect Black Liquor Evaporators.  
Rotary Black Ash Incinerating Furnaces.  
Complete Soda Recovery Equipment.

**SWENSON EVAPORATOR CO.**

945 MONADNOCK BLDG., CHICAGO



# HEATING FAN

with Vertical Enclosed  
Forced Lubricating  
Engine for Textile and  
Pulp and Paper Mills



We also make appliances for Exhausting Steam and Foul  
Air, Heating and Ventilating, Air Cooling Systems,  
Callander Blowers and Piping, etc.

---

**SHELDONS LIMITED**  
GALT - - - ONTARIO

Toronto Office: 609 Kent Bldg.

Agents: Ross & Greig, 412 St. James St., Montreal, Canada.

Grose & Walker, 259 Stanley St., Winnipeg, Man.

R. Hamilton & Co., Bank of Ottawa Bldg., Vancouver, B.C.

VALLEY IRON



WORKS COMPANY

# BEATING AND WASHING ENGINES

IRON OR WOOD TUBS

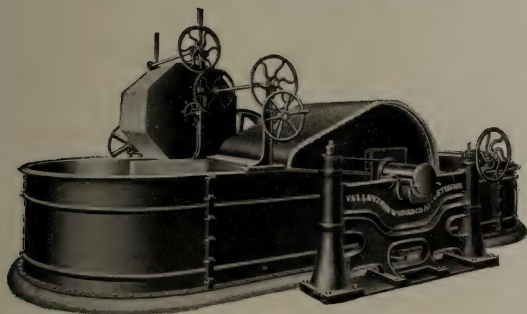

*Perfection in Every Detail*

Beating, Washing and Bleaching Engines. Barkers—Barker Attachments  
—Chippers—Rechippers—Chip Screens (Revolving)—  
Knot Screen (Revolving)—Diaphragm Screens—Felt Washers—Deckers  
(Single and Double)—Stuff Chests (Vertical and Horizontal)—  
Tanks (Blow Off, Acid and Water)—Pulpwood Saws (Friction and  
Steam Feed)—Pulpwood Splitters (Vertical and Horizontal)—  
Shredders and Special Washers for old Paper Stock—Wet Machines and  
Patent Roll Skinners—Bronze, Semi-Steel, Lead and Iron Castings.

Manufacturers of Paper and Pulp Making Machinery in

*All Standard Forms — Many Special Designs*

**ENGINEERS, FOUNDERS AND MACHINISTS**

*Correspondence Invited*

**VALLEY IRON WORKS COMPANY**

**APPLETON, WIS., U.S.A.**

# TOWNSEND

## ELECTROLYTIC CELL

2,500-5000 AMPERE UNITS. ALKALI AND CHLORINE.  
CAUSTIC SODA. BLEACHING POWDER. CHLORINE  
FOR ORES. LICENSES GRANTED. CANADIAN PATENTS  
91939 - 105088 - 105089.

**HOOKER ELECTROCHEMICAL COMPANY**  
40 WALL STREET, NEW YORK

REGISTERED



JOHN KNIGHT, Pres. C. K. WILLIAMS, Treas. C. H. KNIGHT Sec.

## Paper-Makers Chemical Co.

FROM MINE TO MILL

**ENGLISH CHINA CLAYS  
MANUFACTURERS**

**Excelsior Felt Cleaner**

GBB Brand China Clay is  
a natural pure white, no artificial tinting  
Unsurpassed for  
coating, bleaching, or fine papers.

Superior Rosin Size

Superior Satin White

**EASTON, PA., U.S.A.**

## Paper Coating and Colouring Machines

COMPLETE PLANTS AND ACCESSORIES

The best in the world.

To be obtained from

**Julius Fischer Engineering Works Nordhausen, H.**

GERMANY

*Excellent References in all countries.*

## THE PETER HAY KNIFE CO., Limited, GALT, ONT.

MACHINE  
KNIVES,  
CHIPPER,  
BARKER &  
PAPER-  
CUTTER  
KNIVES.

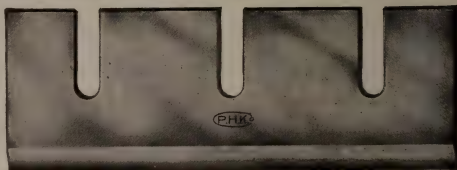

Made from the Best English Steel and Warranted.

# CHR. WANDEL

REUTLINGEN, - GERMANY

ESTABLISHED 1869.

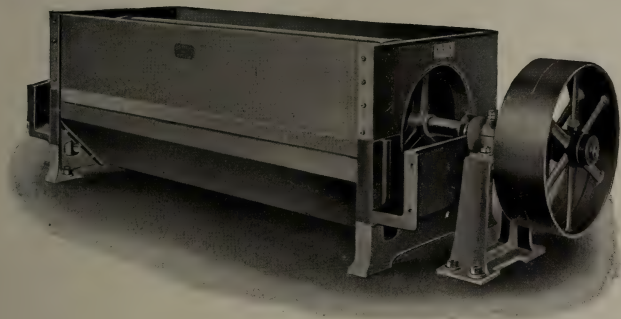

*Manufacturer of the*

## “ORIGINAL WANDEL” Rotary Sulphite Pulp Screen

Satisfactory service sure. Best by test. Beware of imitations. Largest screening surface, combined with small requirement of room. Absolutely reliable and noiseless work. No contact of the pulp with iron parts. Simple, durable, perfect. Price very moderate. The system now adopted by the most important Sulphite Fibre Mills of Europe. Estimates promptly furnished, delivered at any point.

SOLE CANADIAN AGENTS

ARTHUR P. TIPPET & CO.

8 Place Royale

Montreal, Que.

# CROOKES, ROBERTS & Co.

SHEFFIELD

ENGLAND

Makers of  
**Crucible Cast Steel**  
**Bed Plates**  
**Jordan Fillings**  
**Beater Bars**



Makers of  
**Bessemer Cast Steel**  
**Crookes' Composition**  
**Fillings**

And every description of Cutter Knives, Tools and Steel used and required in Paper Mills.

**ARGUS High-Speed STEEL** for fine machine tools is unsurpassed.

Once Used - Always Used  
**YOU SAVE MONEY USING "ARGUS" GOODS**

WRITE US

**ARTHUR P. TIPPET & CO.**

Agents for Canada

MONTREAL

# SPENCER'S

ALWAYS



RELIABLE

Best Wool - Best Weave - Best Wear

**J. H. SPENCER & SONS**

**BURY ENGLAND**

Canadian Agents: **ARTHUR P. TIPPET & CO., MONTREAL**



# INDEX TO ADVERTISEMENTS.

(SEE CLASSIFIED ADVERTISERS INDEX ON PAGE XXXI.)

Ambursen Hydraulic Construction Co. .lxv  
 American Forestry Association ..... lxi  
 Appleton Machine Co. .... iv  
 Atterbury Bros. Inc. ....lxii  
 Becker & Co. .... e o m  
 Beloit Iron Works ..... xliii  
 Bentley & Jackson ..... v  
 Bertram, James & Son, Ltd. .... xviii  
 Bertram's, Limited ..... vi  
 Black-Clawson Co., The ..... x  
 Blethen, Hugh R. ....lix  
 Bredt & Co., F. ....lii  
 Brunner, Mond & Co., Limited .....lxvi  
 Caldwell, H. W. & Son, Co. ....xxxii  
 Canada Coating Mills, Limited. ....lvii  
 Canada Paper Co., Ltd. ....lvii  
 Canadian Boomer & Boschert Press Co. ....ix  
 Canadian Boving Co. ....lv  
 Carthage Machine Co. ....xxiv  
 Castle, Gotthell & Overton .....lii  
 Chambers & Simpson .....vi  
 Chicoutimi Pulp Co. ....xxvi  
 China Clay Co. ....l  
 Christie, J. Co. ....lxvi  
 Christie, Limited, George .....lxv  
 Churchill & Sim .....lxii  
 Crookes, Roberts & Co. ....xlvi  
 Crossley, T. L. ....lviii  
 Dallyn, Jardine & Co. ....lii  
 Dean & Son, Ltd. ....liv  
 De Cew, J. A. ....lix

Dillon Machine Co. ....xiv  
 Dodge Mfg. Co. ....iv  
 Dominion Belting Co. ....xlvi  
 Eaton & Brownell .....lviii  
 Emerson Mfg. Co. ....xxv  
 Farrell Foundry & Machine Co. ....xxxvii  
 Ferguson, H. S. ....lviii  
 Fischer, Julius .....xliv  
 Finckh, Hermann .....xxxix  
 Fullner, H. ....xxx  
 Garland, M. Co. ....xii  
 Gewerkschaft, Sachtleben .....lxiii  
 Gillespie, Geo. H. Co. ....lxv  
 Glens Falls Machine Works .....xlxi  
 Green Bay Barker Co. ....xxi  
 Hamelin, The, & Ayers Co., Ltd. ....lx  
 Hardy, Geo. F. ....lviii  
 Harmon Machine Co. ....viii  
 Hay Knife Co., Peter, Limited .....xli  
 Holyoke Machine Co. ....xvi  
 Hooker Electrochemical Co. ....xli  
 Horn, J. H. & Son .....xxxiii  
 Hough, R. ....lxvi  
 Howell Co., The .....xlvi  
 International Process Co. ....li  
 Jeffrey Mfg. Co. ....lii  
 Jenckes Machine Co. ....xvii  
 Johnson & Sons, Limited, C. H. ....xlxi

## HYDRAULIC TURBINES

One unit of six with a total capacity of 13,100 Horse Power furnished for the new plant of J. R. Booth, Ottawa, Ontario. We build Turbines for any power for heads from 3 to 600 feet.

WRITE FOR CATALOGUE



**S. MORGAN SMITH CO.,**  
 YORK - PA.

Jones, E. D. & Sons Co. ....liv  
 Jones & Glasco .....xx  
 Kimball, Herbert S. ....lviii  
 Klipstein & Co., A. ....l  
 Lawrence Machine Co. ....xx  
 Lawrence Pump & Engine Co. ....lii  
 Lea, R. S. & H. S. Ferguson ....lviii  
 Little, Arthur D. Inc. ....lviii  
 Lyford, Clark & Lyford ....lviii  
 Mallandain, Albert E. ....xxxix  
 Marx, J. & Co. ....viii  
 Mardon, Alfred H. ....lx  
 McDougall, John, Caledonian Iron Works  
 Co., Limited .....xxxv  
 Meincke, C. A. & Co. ....l  
 Milne, Jas., and Son .....e o m  
 Moore & White Co. ....xv  
 National Pipe & Foundry Co., Ltd. ....l  
 New Brunswick Pulp and Paper Co.,  
 Limited .....lv  
 Northern Crane Works, Ltd. ....lxvi  
 Panzl Digester Lining Co. ....lvi  
 Paper Makers Chemical Co. ....xlv  
 Parsons Trading Co. ....xxiv  
 Penmans Limited .....lii  
 Perkins, E. F. & Son .....xxxiv  
 Phillips, S. C. & Co. ....xxxviii  
 Porritt & Son, Joseph .....lii  
 Porritt Bros. & Austin .....xlix  
 Prather, H. B. ....lix  
 Preston's Digester Lining Co. Ltd. ....xxxvi  
 Pride, Chas. B. ....lix  
 Pringle, T. & Sons .....lviii  
 Pullan, E. ....liv  
 Pulp & Paper Trading Co., The ....xxviii  
 Reddaway, F. & Co. ....liv  
 Rice, Barton & Fales .....li  
 Riordon Paper Co., Limited ....lvii

Rolland Paper Co. ....lvii  
 Ryther & Pringle .....xxxiv  
 Sadler & Haworth .....liii  
 Sandy Hill Iron & Brass Works .....x  
 Scandinavian American Trading Co. ....xxix  
 Schaeffer & Budenberg Mfg. Co. ....lxviii  
 Scottish Wirecloth Co. ....lxviii  
 Scott, Ernest & Co. ....xli  
 Sheldons Ltd. ....xlii  
 Sherbrooke Machinery Co., Limited. ....xix  
 Smart-Turner Machine Co. ....lxvi  
 Smith, S. Morgan, Co. ....lxvii  
 Snell, Samuel Co. ....l  
 Spencer, J. H. & Sons .....xli  
 Stancliffe Estates Co., Ltd. ....lxviii  
 Stebbins Engineering & Mfg. Co. ....lix  
 Sweezy, R. O. & W. G. ....lviii  
 Swenson Evaporator Co. ....xli  
 Taylor, J. A. ....lxv  
 Ticonderoga Machine Works .....xxvi  
 Tippet, Arthur P. & Co. ....xxv-xlv-xlvi  
 Union Screen Plate Co. ....liii  
 Union Sulphur Co., The .....lxi  
 United Wire Works, Limited .....xxv  
 Valley Iron Works .....xliii  
 Vera Chemical Co. ....lxii  
 Voith, J. M. ....vii  
 Walker, J. R. & Co. ....lxii  
 Wallace, Jos. H. & Co. ....lix  
 Walksley, Charles & Co. ....xxii-xxiii  
 Wandel, Chr. ....xlv  
 Wandel Screen Mfg. Co., Ltd. ....lx  
 Waterous Engine Works Co., Ltd. ....lxiv  
 Westbye, P. P. ....xi-xxxix  
 West End Engine Works Co. ....xxvii  
 Wilkinson, E. H. ....xxxix-lvi  
 Wilson-Paterson Co. ....xxiv  
 Winn & Holland .....lxvi  
 Zarembo Co. ....e.o.m.

**Scandinavian Sulphite  
 and Ground Wood  
 Kraft Pulp  
 Bleached Sulphate  
 and Sulphite  
 Austrian Bleached  
 Mitscherlich**

Limited quantities still available  
 Write us for quotations and  
 quantities

**THE HOWELL CO.**

8-10 Wellington St. East

**TORONTO - CANADA**

**MAPLE LEAF  
 STITCHED COTTON DUCK  
 BELTING  
 DOMINION BELTING CO. LTD.  
 HAMILTON CANADA**

**The Scottish Wirecloth  
 Company, Limited**

LEITH - - - SCOTLAND

Wirecloth for Paper Machines, etc.

# Glens Falls Machine Works

GLENS FALLS, N.Y.



Sole Manufacturers of

**Tromblee & Paull Rotary Sulphur Burner**

**The Moore Rotary Screen**

**The Reynolds Screen**

Also Manufacture

**Cedar Point Foundry Grinders**

**Improved Standard Grinders**

**Improved Wet Machines**

**Rotary Pumps, etc.**

Write for Particulars and Specifications—they are free.

## C. H. JOHNSON & SONS, Ltd.

WIRE WORKS, ST. HENRY, MONTREAL.

MANUFACTURERS OF

**Fourdrinier Wires, Cylinder Wires,  
Brass, Copper and Iron Wire Cloth, Dandy Rolls**

## PORRITT BROS. & AUSTIN

Stubbins Vale Mills—RAMSBOTTOM—near Manchester, England

Manufacturers of every description of

**FELTS AND JACKETS FOR  
PULP AND PAPER MILLS**

Agents for Canada: C. H. JOHNSON & SONS, Ltd., ST. HENRY, MONTREAL.

**WE MANUFACTURE Wooden Water Pipe** for Water Works Systems. **Specially Made Pipe** for conveying Chemicals. **Continuous Stave Pipe** or Power Plants.  
 Sizes from 2 inches to 12 feet diameter.

**NATIONAL PIPE AND FOUNDRY CO., LIMITED**  
 Works—ALEXANDRIA, Ont. 135 Board of Trade Bldg., MONTREAL, Que.

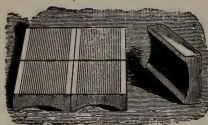

### Use Snell's Drainer Bottoms

They drain quickly and don't let the Pulp go into River. **No Dust. No Splinters. Clean Stock.**

*Send for Sample and Price*

**Samuel Snell Co., - Holyoke, Mass.**

Cable Address:—"Kaolin, Manchester." A.B.C. Codes 4th & 5th Edition

# CHINA CLAY CO.

JOHN WILLIAMSON, Manager.

4 St. Anne's Square

**MANCHESTER, ENG.**

**MINES—Ruddle, Bojea, Colchester, South Ninestones, Tronance, St. Austen Cornwall.**

**CONTRACTORS TO H.M. INDIAN GOVERNMENT**

**Canadian Representatives—C. A. Meincke & Co., 222 Coristine Bldg., Montreal.**

## A. KLIPSTEIN & Co. Ltd.

(OF CANADA)

12 ST. PETER ST.

MONTREAL

# SULPHATE ALUMINA

**CHINA CLAY, BLEACH and CASEIN  
 PAPER BLUE, both Basic and Acid  
 AURAMINE - RHODAMINE**

and all other Aniline Colors

Shades Carefully Matched in our Laboratory

Mention Pulp & Paper  
 Magazine

**New York Office - 644-654 Greenwich Street.**

THE PROCESSES AND APPARATUS  
THAT MADE "KRAFT PAPER" SUCCESSFUL



CABLE ADDRESSES  
KRAFTLICH, NEW YORK.  
INPROKRAFT, LONDON.

# INTERNATIONAL PAPER PROCESSES CO.

EUROPEAN OFFICES  
SALISBURY HOUSE,  
LONDON, ENGLAND.

AMERICAN OFFICES  
5 BEEKMAN STREET  
NEW YORK, N.Y.

SOLE AGENTS IN NORTH AMERICA  
FOR  
CARL P. CARLSON, SWEDEN.  
EVAPORATORS AND LIQUOR SYSTEMS.

JULIUS PINTSCH, ACTIENGESSELLSCHAFT, GERMANY.  
DIGESTERS, DIFFUSERS AND SPECIALTIES.

SWEDISH SYSTEM OF RECOVERY FOR  
TURPENTINE, ALCOHOL AND OTHER BY-PRODUCTS.

ENGINEERS, CHEMISTS, PULP EXPERTS.



**LAWRENCE PUMP  
AND ENGINE CO.**

P.O. BOX 70, DEPT. 10  
LAWRENCE :: MASS.

**CENTRIFUGAL PUMPS**

We make an exclusive specialty of High Efficiency Centrifugal Pumps for Paper and Pulp Mill. In one mill 49 of our Pumps are running, the customer writes— "Your Pumps are all giving perfect satisfaction."

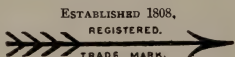

**FELTS** For Pulp and Paper Mills.

**JOSEPH PORRITT & SONS**

Agents for  
Canada  
and United  
States.

**HELMSHORE**  
Manchester, England.

All kinds  
Woollen, Lin-  
en and Cotton  
Cloths for  
Mechanical  
Purposes.

**F. BREDT & CO., 240 Water Street, NEW YORK.**

**PENMANS LIMITED**  
**ST. HYACINTHE, QUEBEC**

Manufacturers of  
**PULP AND PAPER MAKERS' FELTS,  
JACKETS, STRAINER CLOTHS, ETC.**

Special sizes and qualities made to order. Satisfaction guaranteed.  
**DALLYN, JARDINE & CO. TORONTO Selling Agents**

**CASTLE, GOTTHEIL & OVERTON**

*200 Fifth Avenue, New York*

AGENTS FOR

**Sulphite and Wood Pulp Mills**

Dealers in all kinds of Paperstock, Sizing, etc.

Correspondence Solicited.

Remember  
This—



Waterproof

# Leather Belting

Costs less per day of service

MADE ONLY BY

*Sadler & Haworth*

Tanners and Manufacturers

MONTREAL

511 William Street

TORONTO

27 Melinda Street

ST. JOHN, N.B.

WINNIPEG

VANCOUVER

89 Prince William St.

244 Princess Street

217 Columbia Ave.

*For over thirty-five years the makers of the best leather belts*

Nearly FIFTY YEARS ago we introduced this Belt. IT HAS STOOD THE TEST OF TIME

2" to 24" in stock

Every Belt is  
Stamped with  
Trade-Mark.

SOLE MAKERS



Write or phone us

Beware  
of Imitations

F. REDDAWAY & CO.,

MONTREAL, CANADA.

**E. PULLAN,** 490 Adelaide St. W.,  
TORONTO  
Largest Paper Stock Dealer in Canada  
**RAGS AND PAPER STOCK GRADED TO SUIT MILL REQUIREMENTS**  
Correspondence Solicited.

EDWARD A. JONES, President and Treasurer

WALLACE E. BARDWELL, Secretary

**E. D. JONES & SONS CO., Pittsfield, Mass.**

Manufacturers of

**PAPER MAKING MACHINERY  
AND MECHANICAL ENGINEERS**

Beating Engines. Washing Engines. Mixing Engines. Bleaching Engines.  
Cooking Engines. Vertical and Horizontal Stuff Chests.

Jordan Engines of three sizes, either belt or direct connected motor driven;  
fillings of Wagg Steel or stone type, three-part or plain.

Dusting Machinery of all kinds.

NEW EDITION FOR 1912 NOW READY

A BOOK YOU ARE SURE TO WANT

PRINTED IN CLEAR TYPE

ALPHABETICALLY ARRANGED

## The Paper Maker's Directory of all Nations

Annuaire de la Papeterie de Toutes les Nations.

Internationales Adressbuch sämtlicher Papierfabrikanten der Welt

### Contents Include

Paper, Pulp and Board Mills. Names and Addresses of more than 5,000 in 40 different Countries, with (1) Makes of Paper; (2) Number and width of Machines; (3) Tonnage Output; (4) Power Used; (5) Telegraphic Addresses; (6) Agents, etc.  
Classified Lists of Principal Productions for each country.  
Special Buyers' Guide.  
Paper Agents and Mill representatives (with Mills represented).  
Paper stainers, Enamellers and Surfacers of Paper.

Wholesale Stationers and Paper Merchants.

Waste Paper Merchants and Rag Merchants & Paper Stock Dealers.

Export Merchants Shippers of Paper.

Cardboard and Paper Box Manuf'rs.

China Clay Merchants.

Paper Bag Makers.

Buyers' Guide.

Sizes (with folds) of British Papers.

Paper Trade Customs, Paper Equiva-

lents, &c., &c.,

British Paper Trade Customs.

The Red Book of the  
British Paper  
Industry



Demy 8vo, Cloth Bound  
796 Pages

PRICE 10/6 NET, POST FREE 11/6

TO BE OBTAINED FROM

**DEAN & SON Ltd. - 160a Fleet St.  
LONDON, E.C.**

# "C.B.C." REFINER

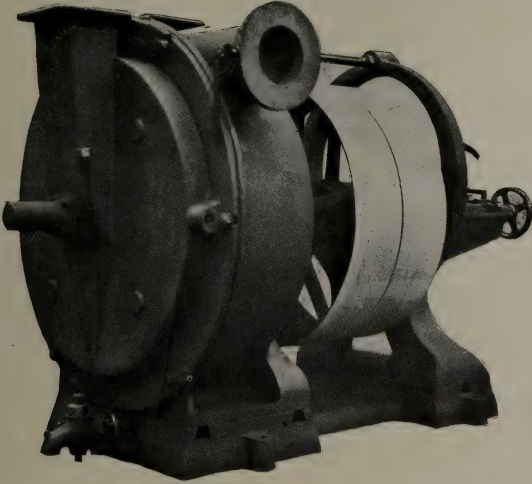

*Great strength and durability.*

*Large working capacity.*

**IT SAVES YOU ALL YOUR SCREENINGS  
i.e., 5 to 10 per cent. of your wood consumption**

**IT INCREASES YOUR PRODUCTION  
5 to 10 per cent. without additional power**

## **The Canadian Böving Co., Limited**

**164 BAY ST. - - TORONTO**

**VANCOUVER OFFICE - - 448 SEYMOUR ST.**

## ROLLAND'S PAPERS

For Business Stationery, for Loose Leaf Sheets and all kinds of printed or lithographed forms, include many textures at a wide price range. There is a paper for every need and fancy. Ask your printer to show you our sample books, or write to us for them.

Made in White, Azure and Buff. Envelopes to match all lines.

### THE ROLLAND PAPER COMPANY LIMITED

GENERAL OFFICES - MONTREAL, P.Q.  
MILLS AT ST. JEROME AND MONT ROLLAND, P.Q.

## GENUINE "KRAFT" PAPERS

*Made in Canada*

### THE NEW BRUNSWICK PULP & PAPER CO.

Springfield Mills, Millerton, N.B. Limited

Ontario Representative - E. H. WILKINSON

Telephone Building, 82 Adelaide Street West - TORONTO

## PANZL'S PATENTED LINING COMPOSITION

IS THE SAFEST AND BEST MATERIAL FOR

**LINING OF SULPHITE PULP DIGESTERS**

AND ACID RECLAIMING TANKS

**PANZL LININGS ARE SAFEST AND MOST DURABLE**

They are really acid-proof and practically indestructible.

All Digesters lined with Panzl's patented composition, now as tight and in as good condition after years of continuous use as they ever were, no leaks and no repairs.

Panzl Linings can be made considerably thinner than the other linings, thus increasing the capacity of the digesters

The composition and the system of constructing of Panzl Linings are patented in all countries where wood pulp is being manufactured by the sulphite process. The PANZL U.S. Patents have been adjudicated to be valid in law and wholly independent of all prior patents relating to linings of digesters.

For information and estimates, address:—

**PANZL DIGESTER LINING COMPANY**

505 Washington Ave., Muskegon, Mich.



## The Riordon Paper Company, Limited Fibre, Paper, Lumber.

MONTREAL - CANADA

News Paper, Hanging Paper, Wrapping Paper, Building Paper,  
Celebrated "Impervious" Spruce Sheathing and Sulphite Fibre for all  
kinds of Paper.

## Barber Paper and Coating Mills Ltd. GEORGETOWN, ONT.

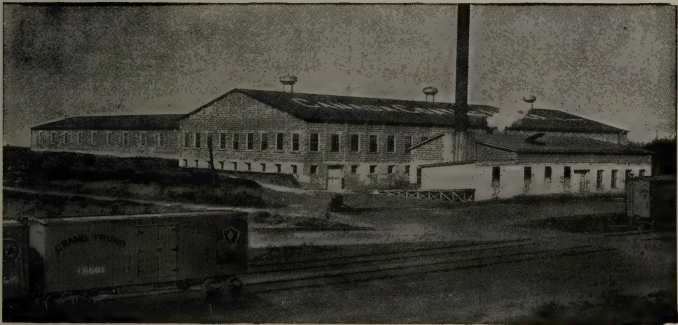

Manufacturers of  
SURFACE COATED BOOK and LITHOGRAPHIC  
PAPERS, COATED CARDBOARD and COATED  
BOXBOARDS of every description.

## "Chalk White" Coated Book Paper.

The best and whitest coated paper sold.

**ALL REGULAR SIZES AND WEIGHTS IN STOCK.**

Our Art Litho Cover Paper is stocked in four tints,  
2 sizes. 20 x 25 and 21½ x 28½. Samples gladly sent.

MONTREAL  
TORONTO

**CANADA PAPER Co.**  
LIMITED

WINDSOR  
MILLS, P.O.

# DIRECTORY

of

## Civil and Chemical Engineers

### T. PRINGLE & SON, Limited

Engineers and Architects

Plans and Specifications for Pulp and Paper Mills, Power Plants and other Industrial Works.  
**Coristine Bldg;** **Continental Life Bldg.**  
**Montreal.** **Toronto.**  
 Bell Tel.: M. 3890. Tel.: M. 5917.

### R. S. LEA, and H. S. FERGUSON, ENGINEERS

Pulp, Paper and Chemical Fibre Mills.  
 Water Power Development and Transmission. Steam Power Plants.  
 Telephone Long Distance U. S. 75L.  
 820 New Birks Bldg., MONTREAL

### Arthur D. Little Inc.

— LABORATORY OF —  
 ENGINEERING CHEMISTRY  
**93 BROAD ST., BOSTON, - MASS.**  
 Our staff includes experts in Papermaking Chemistry  
 —Sulphite Mill Practice—Fuel Engineering.

### GEORGE F. HARDY, M. AM. SOC., M. E. M. CAN. SOC. C. E.

Consulting Engineer.  
 Paper, Pulp and Fibre Mills, Examination of Mill Properties, Water Power Developments.  
**Mutual Reserve Building, - 309 Broadway,  
 NEW YORK.**

CHARLES E. EATON, M. Am. Soc., M. E. JAMES P. BROWNELL, C. E.

**EATON & BROWNELL,**  
**Consulting Engineers and Architects.**  
 Paper, Pulp and Fiber Mills, Water, Steam and Electric Power Development, Examination of Properties, Consultation Reports.  
**SMITH BLDG. WATERTOWN, N. Y.**

ENGINEERS SHOULD WRITE  
 THE PUBLISHERS FOR RATE  
 OF CARDS ON THIS PAGE.

### T. LINSEY CROSSLEY

*Engineering Chemist*  
**PULP AND PAPER  
 TECHNOLOGY**

318 Lagachetiere St., W., Montreal

### R. O. & W. G. SWEEZEY

— Civil and —  
**Forest Engineers**

Limit cruising, surveys, water storage,  
 power, lumbering contracts.

**METROPOLITAN BLDG., QUEBEC**

ASSOCIATED WITH

**HERBERT S. KIMBALL**

M. AM. SOC. C. E.

*Mill Architect and Engineer*

111 Devonshire St., Boston

### FOREST ENGINEERS

FOREST SURVEYS TIMBER ESTIMATES LOGGING MAPS  
 WATER POWER WATER STORAGE  
**CLARK, LYFORD & STERLING**  
 1331 Real Estate Trust Bldg., Philadelphia  
**CLARK & LYFORD LYFORD, CLARK & LYFORD**  
 403 Crown Bldg. 26 Board of Trade Bldg.  
 Vancouver. Montreal.

**PULP  
PAPER  
POWER** JOSEPH H. WALLACE & CO.  
INDUSTRIAL ENGINEERS.  
TEMPLE COURT BLDG. NEW YORK.  
SALISBURY HOUSE, LONDON, E.C  
CABLES, TRIPLEX, N. Y., TRIPLEX IS, LONDON.

**C. B. PRIDE**  
MILL ARCHITECT & ENGINEER  
PAPER, FIBER, AND PULP MILLS,  
— WATER & STEAM POWER DEVELOPMENT  
25 YEARS SUCCESSFUL OPERATIONS  
SPOKANE, WASH OFFICES APPLETON, WIS.

**J. A. De CEW** M.A. INST. CHEM. ENG.  
A.M. CAN. SOC. C.E. *Chemical Engineer*  
Paper Mill Analysis Pulp Testing Investigations  
Sulphite Fibre, Soda Fibre Reports  
CANADIAN EXPRESS BUILDING - - - MONTREAL

Power, Lighting, Heating, Ventilating and Drying.—Complete New Plants, Improvement of Old Plants ;  
Plans, Specifications, Contracts, Estimates, Tests, Appraisals. Inspections and Reports.—Pulp, Paper,  
Box Board and Coating Mills.  
Lowest **H. B. PRATHER,** Guaranteed  
Possible *CONSULTING ENGINEER,* Results.  
Operating Cost. ROCKFELLER BLDG., CLEVELAND, O.

**HUGH R. BLETHEN**  
21 PARK ROW, - - - NEW YORK, N.Y.  
Traveling Cranes - Overhead Tramways - Trolleys and Chain  
Hoists for Paper and Pulp Mills - Power Houses.

**Stebbins Engineering & Mfg. Co.**  
**WATERTOWN, N.Y.**  
MANUFACTURERS OF  
STEBBINS' ACID SYSTEMS, SULPHUR BURNER  
DIGESTER LININGS, RECLAIMERS, ETC.  
Engineering Department under Mr. T. L. TOMLINES  
Plans, Estimates and Specifications for Paper,  
Pulp and Fibre Mills,  
Water Power and Hydro-Electric Developments

## LEUNIG PAPER SCALES

Showing correctly at a glance, by weighing a single sheet, the weight of a ream of Paper of any size, containing either 480, 500, or 516 sheets.

Can also be made to indicate in addition to the English weight, the weight in Kilogrammes.

Illustrated Price List on Application.

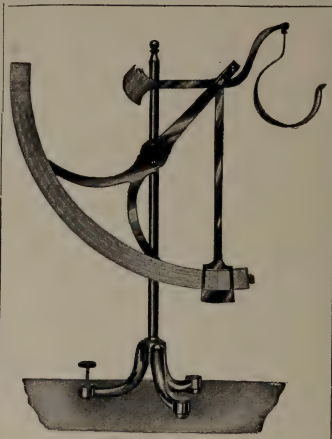

$\frac{1}{2}$  to 80 lbs.

**Price,**  
**Ten Dollars**  
F.O.B., London

$\frac{1}{2}$  to 120 lbs.

**Price,**  
**Fourteen Dollars**  
F.O.B., London

Illustrated Price List on Application.

**Alfred H. Mardon** 150 Shaftesbury Ave. **London, Eng.**

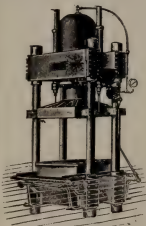

## PULP PRESSES

AND ACCESSORIES

CANADIAN BOOMER & BOSCHERT PRESS  
COMPANY, LIMITED

18 TANSLEY STREET, MONTREAL

"LACHUTE FELTS" Bell Tel. No. 23

**The Hamelin & Ayers Co., Limited**

LACHUTE MILLS, P.Q.

MANUFACTURERS OF EVERY DESCRIPTION OF

**FELTS** FOR PAPER AND  
PULP MILLS

"The Best are the Cheapest."

People who are wise Advocate Forestry

# The American Forestry Magazine

IS DEVOTED TO SECURING

Better Fire Protection

Fair Forest Taxation

Lower Freight Rates

Proper Legislation

Conservative Management

and Reforestation

It should be on the desk of every progressive American citizen. It is the public service publication of the American Forestry Association

AMERICAN FORESTRY MAGAZINE, ONE YEAR - \$2.00

Membership in American Forestry Association, One Year - \$1.00

---

Address AMERICAN FORESTRY ASSOCIATION  
Washington, D.C.

# The Union Sulphur Company

Producers of the Highest Grade Brimstone on the Market

---

Absolutely free from Arsenic, Selenium or Tellurium

---

## The Largest Sulphur Mine in the World

CALCASIEU PARISH, - LOUISIANA

Main Offices : Whitehall Bldg., 17 Battery Place  
NEW YORK



**WE GUARANTEE OUR SIZINGS TO BE ABSOLUTELY CLEAN  
OUR VERA PAPER SIZE**

is purest, strongest and highest free rosin size made. We can furnish you with an ideal rosin size and patented apparatus to use same.

**OUR VERA MILL SIZE**

is the best soluble paper makers' rosin size made. Ready to use in cold or warm water in the ordinary way without apparatus. Gives better satisfaction and is more economical than mill made size.

Our sizings are cleaned by our new patented process, and we guarantee this size to be absolutely clean, without the least speck of impurity in the same, preventing thereby black specks in the paper. We are shipping our size in barrels or tank-cars.

**VERA CHEMICAL COMPANY**

Main Office and Western Factory  
NORTH MILWAUKEE, WIS.

Eastern Factory  
STONEHAM, MASS.

**J. R. Walker & Co.**

Importers and  
Packers of

**GRADED RAGS, PAPER STOCK  
ROPE BAGGING, ETC.**

WAREHOUSE, 35 COMMON ST., MONTREAL.

Also Manufacturers of Roofing and Building Papers, Leatherboard and Friction Board

Mills at Sault au Recollet, P.Q.

**ATTERBURY BROTHERS, Incorporated.**

*Importers and Exporters.*

**Wood Pulp, FOREIGN AND DOMESTIC Rags AND Paper Stock**

Potter Building, 145 Nassau Street, New York City.

Cable address "AFFECTIVE," New York.

**CHURCHILL & SIM**

29 CLEMENTS LANE, LONDON, E.C.

And at Manchester

**WOOD PULP AGENTS**

Telegraphic Address:—  
"CHURCHILL, LONDON."

A.B.C. CODE  
5th Edition



# If Your Grinder Valves Leak Stop 'em!



There is no one thing that causes more annoyance around the Pulp mill than leaky grinder valves.

## THE WATEROUS GRINDER VALVE

overcomes that.

It is designed to be a tight valve, and it can be kept so.

Of the piston type the valve body is exceptionally strong, is lined with seamless brass tubing, has rods and pistons of bronze and is built and tested to stand a pressure of 100 lbs. per square inch.

When repairs are needed, all that is necessary is to replace the two cup leather packings—done in a few minutes—and the valve is as good and as tight as new.

THE WATEROUS GRINDER VALVE uses single or double pressure as desired—one lever operates both. The Waterous Valve fits any cylinder. It can be placed in any of four positions to be most convenient for the operator.

Let us fit one on your grinder and show  
you what we mean by a "tight valve."

**The Waterous Engine Works Co., Ltd.**  
BRANTFORD, - CANADA

**Geo. Christie Ltd.** - - - **Glasgow  
Scotland**

**FOURDRINIER MACHINE WIRES**

Unequalled for Strength, Smoothness and Long Life

**CYLINDER COVERS**

Canadian Agent:

**J. A. Taylor, 22 St. Francois Xavier St., Montreal**

**CANADIAN TALC FILLER**

**GEO. H. GILLESPIE COMPANY**

**MADOC - - - ONTARIO**

*The only Manufacturers of Paper Filler in Canada.*

Our Filler is used in Canada, United States, England, Germany,  
Austria, Holland, Russia and Scandinavia.

**AMBURSEN HYDRAULIC CONSTRUCTION CO.,**

**OF CANADA, LIMITED**

**822 New Birks Building - MONTREAL**

*Associated with the Ambursen Hydraulic Construction Co., of Boston, Mass.*



**Concrete Steel Dam**

OF THE

**MISSISQUOI PULP CO.,**

**Sheldon, Springs, Vt:**

Mid-channel, height 49 feet.  
Total length 279 feet (only 180  
feet shows in the picture, the  
remainder being concealed at  
the left.)

Dam specially designed to with-  
stand heavy ice gorges.

Factors of safety, are calculated  
for a 12-foot flood.

**IF YOU HAVE A DAM TO BUILD, WRITE US NOW.**

Every Grade of Waste for  
Paper Making.

# R. HOUGH

LONDON, England.

Agent for Canada and U.S.,

**THE J. CHRISTIE CO.**

5 King St. West, TORONTO, Canada.

STEAM PUMPS  
CONDENSERS  
VACUUM PUMPS  
TRIPLEX POWER PUMPS  
CENTRIFUGAL PUMPS

The Smart-Turner  
Machine Co., Limited

HAMILTON

CANADA

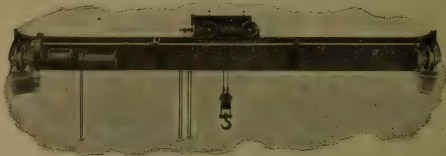
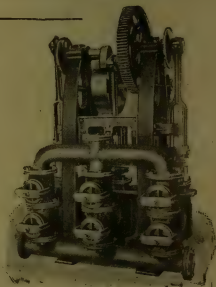

**NORTHERN  
CRANES**

and Hoists  
Overhead  
Track and  
Trolley  
Systems

Northern Crane Works Ltd.  
WALKERVILLE - ONTARIO

## WINN & HOLLAND, Limited

MONTREAL

PULP AND PAPER CHEMICALS.

Sole Agents for:

**BRUNNER, MOND & CO'S.**

SODA ASH,

BLEACHING POWDER,

SAL SODA,

CAUSTIC SODA, &c.



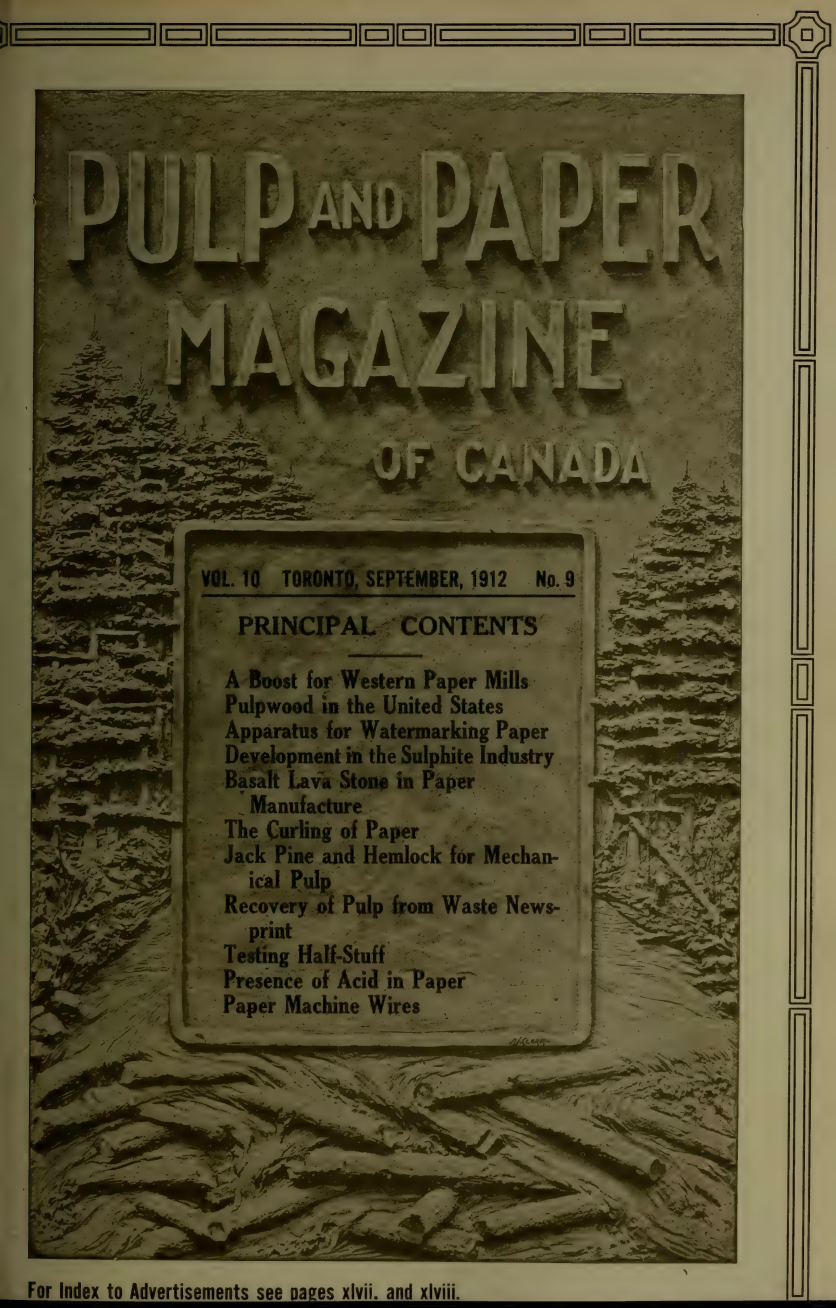

# PULP AND PAPER MAGAZINE OF CANADA

VOL. 10 TORONTO, SEPTEMBER, 1912 No. 9

## PRINCIPAL CONTENTS

A Boost for Western Paper Mills  
Pulwood in the United States  
Apparatus for Watermarking Paper  
Development in the Sulphite Industry  
Basalt Lava Stone in Paper  
Manufacture  
The Curling of Paper  
Jack Pine and Hemlock for Mechanical Pulp  
Recovery of Pulp from Waste Newsprint  
Testing Half-Stuff  
Presence of Acid in Paper  
Paper Machine Wires

# THE JONASSEN PULP REFINER

For the Reclaiming of Ground  
Wood and Sulphite Screenings

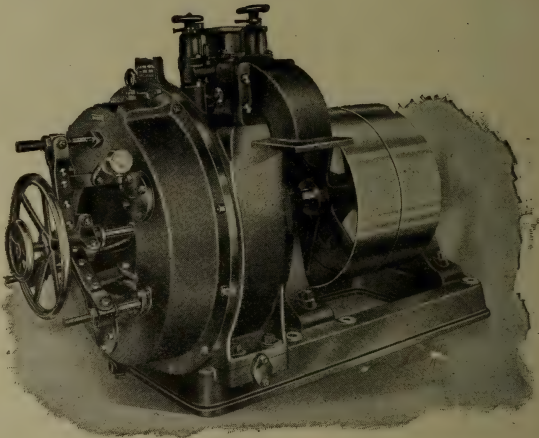

With this Refiner you save all your Ground Wood and Sulphite Tailings or Screenings, which now go to waste.

Capacity of Machine: From 8 to 10 tons of Screenings a day.

Power required to operate same: 20 horse power.

Write us for prices and further information.

## Rice Barton and Fales Machine and Iron Co.

WORCESTER, MASSACHUSETTS, U.S.A.



## 40,000 Cords of Pulp Wood, Stored, Stacked and Reclaimed by 1800ft. Jeffrey Wire Cable Conveyor

The wood is delivered to storage by cable on the upper run and reclaimed by the return cable which travels underneath the pile.

**Jeffrey Wire Cable Conveyers** have greater efficiency, are more economical in operation and cost less to install and maintain than any other type of conveyer used. We build them from the ground up.

Let us plan an equipment to meet your requirements.

WRITE FOR BULLETIN 33

# JEFFREY MANUFACTURING CO.

Canadian Works and Main Office, Montreal  
Winnipeg Representatives, - - N. J. Dinneen & Co.

E. J. WELCH, *President and Managing Director*  
HENRY W. S. DOWNS, *Superintendent*

EMMONS CROCKER, *Vice-President*  
A. S. MORSE, *Secretary and Treasurer*

# SCREEN PLATES



The "Union" Bronze (best phosphorized cast metal) Plates for Sulphite Mills. The Standard Rolled Brass Plates. The "Union" Cast Metal Suction Plates.

We carry a large stock of blanks of the various sizes in both metals and can fill all orders promptly.

Old plates reclosed and recut by our process are practically as good as new and give better results than by any other process

## Union Screen Plate Co. of Canada, Limited

FACTORY : LENNOXVILLE, QUEBEC.

OFFICES : Lennoxville, Quebec, and Fitchburg, Massachusetts, U. S. A.

— THE BEST —  
**JORDON ENGINE**  
 IS BUILT BY THE

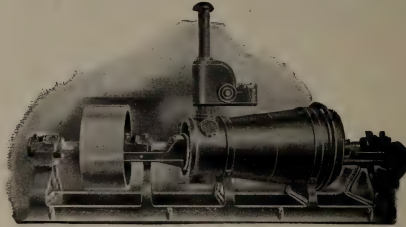

**APPLETON MACHINE CO.**  
 APPLETON, WIS.  
 SEND FOR PARTICULARS

**DODGE**  
**Transmission** —\*—  
 —\*— **Machinery**  
 — High Grade Only —

Shafting, Hangers, Pulleys,  
 Friction Clutch Pulleys.

**DODGE MANUFACTURING CO.**

640 ST. PAUL ST. HAYMARKET SQUARE **MONTREAL** LIMITED



Telegrams :  
"CALENDER, BURY"

Telephone :  
NUMBER 340

# Bentley & Jackson,

Limited

PAPER MAKERS'

.. ENGINEERS ..

BURY, - - ENGLAND

*SPECIALITIES.*

MODERN HIGH SPEED NEWS PAPER  
MAKING MACHINES

SINGLE CYLINDER PAPER MAKING  
MACHINES

The NEW "*MARSHALL*" *PATENT REFINING ENGINE*, with separate adjustment to cones and discs, and our Patent Ball Thrust Bearing.

---

**APPLY FOR PRICES.**

---



# Bertrams Limited

SCIENNES

Edinburgh

- -

Scotland

PAPER MILL MACHINERY

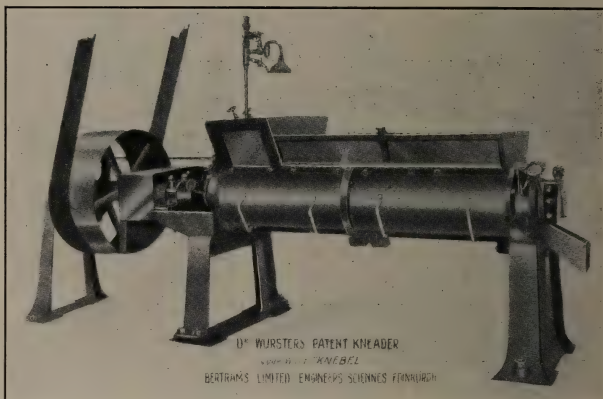

This Machine will be in operation at the North East corner Machinery Hall, at the Canadian National Exhibition, Toronto, Aug. 24th, September 7th.

Any mills desirous of having waste treated, are asked to consign sample to Chambers & Simpson, at Exhibition, which will be returned in a reduced state.

Full particulars from

**CHAMBERS & SIMPSON**

152 Bay St. - Toronto, Ont.

# J. M. VOITH

Engineering Works and Foundries

HEIDENHEIM  $\frac{1}{2}$  Brz. - - (Wurt.)

Voith's  
Magazine  
Grinder

Patented in all  
the principal  
countries

Manufactured  
in Canada

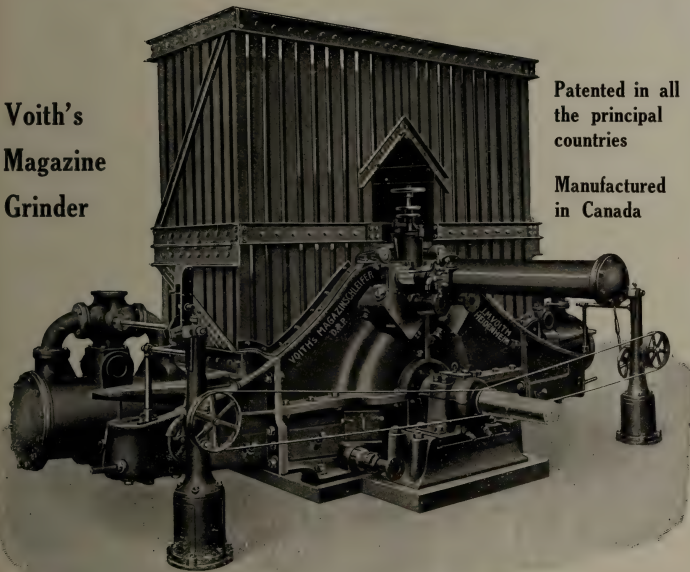

Automatic Feeding and Reversing of Presses. 1 Grinder consumes up to 1200 h.p.  
Of more than 65 apparatus ordered, 25 already delivered  
and working most satisfactorily

SPECIALTIES— COMPLETE MACHINERY FOR  
WOOD PULP, PAPER AND SULPHITE MILLS

Branch Office for Canada and U.S.A. - 1008 Fifth Ave. Bldg., New York  
H. F. STORRER, C.E.

**J. Marx & Co., - - - London, E.C., England**

Double Beaters with 1 Basalt Lava Roll and 1 Steel Roll in Concrete Beater Troughs, greatly improve quality of paper, especially News.

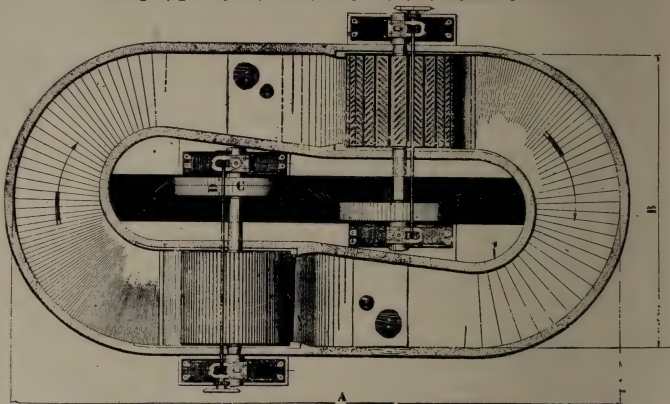

**SPECIALITIES:** Margalt Suction Rolls, Basalt Lava Stone Beater Rolls, Stone Wet Press Rolls, Basalt Lava Pulp Refiners for Screenings.

Canadian  
Representative

**Judson A. DeCew**

Canadian Express  
Building

**Montreal**

*The*

## Harmon Incline Screening System

Will give greatest capacity.

Will give cleaner stock.

Will save power.

Will save labor.

Does not require use of Rakers.

Write us for full descriptive Catalogue and testimonials from the best mills in the country.

# HARMON MACHINE COMPANY

WATERTOWN, N. Y., U. S. A.

OTTO WANDEL  
President

HERBERT H. MILLER  
Treasurer

# Wandel Screen Manufacturing Co.

WALPOLE, MASS., U.S.A.

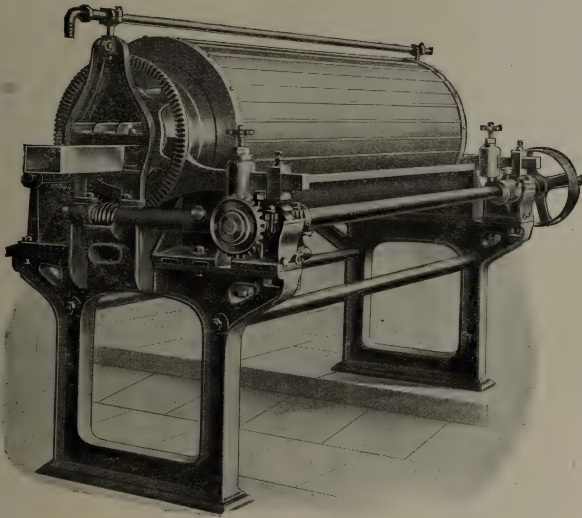

MANUFACTURERS OF THE

Quick Delivery.

Write for Catalogue  
and list of users.

We have no author-  
ized Agents in  
Canada.

# WANDEL ROTARY SCREEN

Over 200 Wandel  
Screens have  
been built and sold  
by us in the States  
within two years.

## SUPERIOR CONSTRUCTION

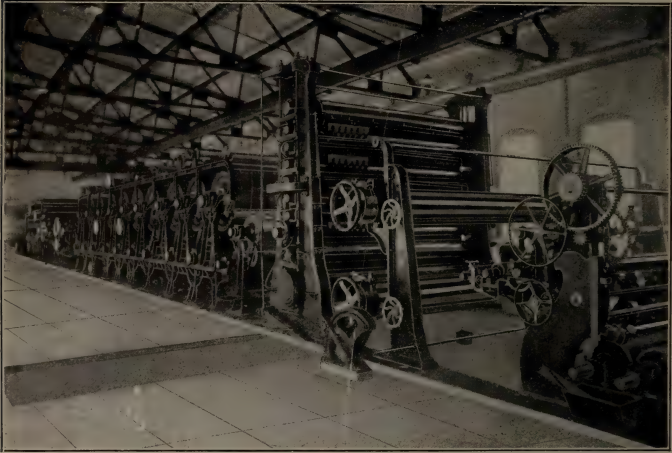

---

**THE SANDY HILL IRON AND BRASS WORKS, HUDSON FALLS, N.Y.**

130" HARPER FOURDRINIER PAPER MACHINE

---

## A GOOD JORDAN ENGINE

BUILT IN 3 SIZES.



## THE BLACK-CLAWSON CO.

HAMILTON, OHIO, U.S.A

Builders of **PAPER MAKING MACHINES** and machinery for Paper and Pulp Mills. Our machines are completely erected in shop on cast iron levelling plates and carefully inspected before shipment.

*Write for Catalogue.*



# The "WESTBYE" SCREEN

*Its Novel Features are of Importance to You*

Built for Belt or Motor Drive

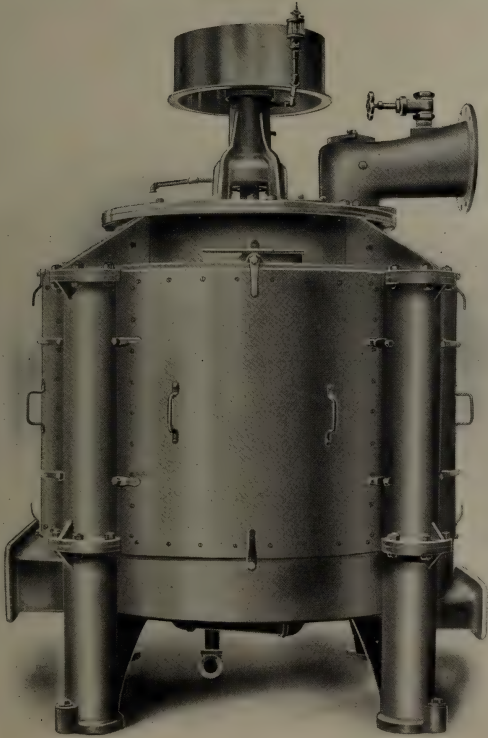

Investigate and learn something NEW in the screen line

*For Details and Prices  
apply to*

**P. P. WESTBYE**  
PETERBOROUGH,  
CANADA



**MOVABLE CRANE  
PULP LOG  
STORAGE SYSTEM  
AND UNLOADER**

---

---

**The M. Garland Company**

BAY CITY, MICHIGAN

**Inventors of the Cable Conveyer**

# Have You Heard the Facts About The Beloit Machines?

---

---

One Fourdrinier built for 500 feet has run 615 feet, and averages 550 feet and makes 72,000 lbs. of print in 23 hours, 110 inch trim.

Another, built for 350 feet, for manillas, is running 490 feet every day on print.

Two others, built for 250 feet on book, are now speeded up to 340 feet on book.

A cylinder machine built for 40 tons of strawboard has made 89 tons in 23 hours, and averages 76 tons per day, dryers are 116 inch face.

---

---

## Beloit Iron Works

BELOIT, WIS., U.S.A.

# DILLON MACHINE CO

BUILDERS OF

## PAPER MILL MACHINERY

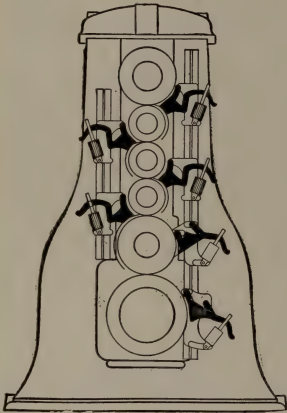

- Beating Engines
- Washing Engines
- Jordan's Three Sizes—  
Single, Double & Triple
- Stuff Pumps, with  
Dillon Patent Valve  
Seating
- Brannan Patent Paper  
Folders
- Horizontal and Vertical  
Stuff Chests
- Single and Double Paper  
Cutters
- Backstands
- Plates, Knives and Bars

DILLON  
 PATENT  
 DOCTORS  
 AND FEEDS  
 MADE IN  
 CANADA  
 BY THE  
 SHERBROOKE  
 IRON WORKS,  
 SHERBROOKE, P.Q.

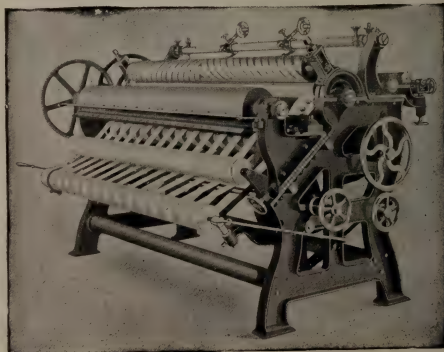

# LAWRENCE, MASS., U.S.A.

---

---

# THE MOORE & WHITE CO.

ENGINEERS, FOUNDERS, MACHINISTS

## PAPER MACHINE BUILDERS

Inquiries solicited and given prompt and careful attention.

Specifications and estimates for paper and pulp machinery on either new or repair work cheerfully given

Quality guaranteed strictly high-grade



Office and Works, North Philadelphia Station, P. R. R.  
Philadelphia, U. S. A.

PAPER MACHINES FOR ALL GRADES OF PAPER

ALL GRADES OF BOX BOARDS

ROOFING, FELT AND BUILDING PAPERS

---

SATURATING AND ASPHALT COATING MACHINERY

“M & W” FRICTION CLUTCHES

AND “M & W” VARIABLE SPEED CHANGES

PRINTING MACHINES

FOR FLOOR CLOTH AND LINOLEUM

*Bulletins and information on any of the above subjects sent on request.*

---

---



# HOLYOKE MACHINE COMPANY

## HOLYOKE, MASS., U.S.A.

MANUFACTURERS OF

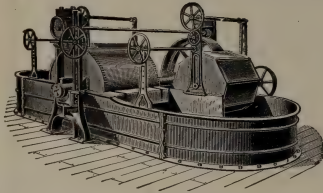

Washing and Beating Engines with  
Patent Double Hoist and Tubs of either  
wood or iron.

Hydraulic Pumps and Presses.

Rag Cutters and Rag Dusters.



Cotton and Paper Rolls with Patent Fastenings.

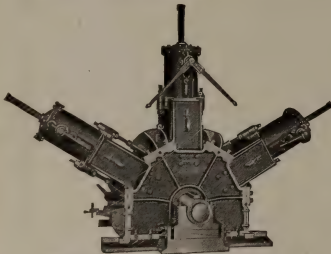

Patent Improved Wood Pulp Grinder.

Elevators, Rotary Fire Pumps and  
Friction Gearing.

Gears Accurately Spaced and Planed.

Shafting, Pulleys and Mill Work.

Machinery for Wood Pulp and  
Paper Mills.

Vertical and Horizontal Water  
Wheels with Flumes and  
all connections.

Wood Barkers, Wood Chippers  
and Wet Machines.

## Newest Designs

AND

## Highest Efficiency

Calenders. All kinds of Super  
Calenders, Friction Calenders  
and Platers.

Chilled Iron Rolls.

Special Machinery

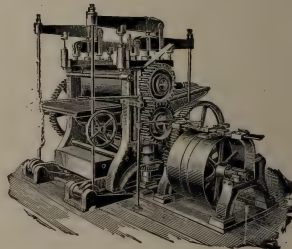

**Description and Estimates Furnished; also Gear List  
and Catalogs sent on application.**

# Pulp Mill Machinery

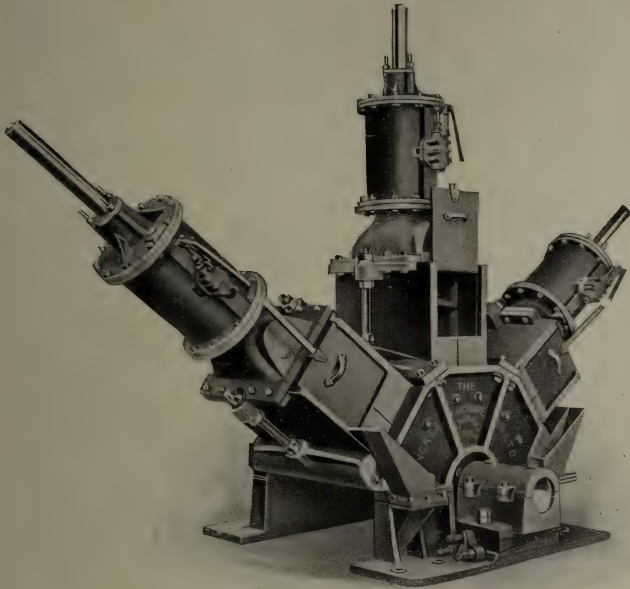

Our Grinders combine the latest and best features in Wood Pulp Grinder construction and have many recent improvements.

We also manufacture Wet Machines, Screens, Presses, Barkers, Complete Wood Room Equipment and Turbine Water Wheels.

LET US QUOTE ON YOUR REQUIREMENTS.

## The Jenckes Machine Co., Limited

General Offices: SHERBROOKE, QUE.

Factories: Sherbrooke, Que., St. Catharines, Ont,

Sales Offices: SHERBROOKE, MONTREAL, ST. CATHARINES, COBALT  
SOUTH PORCUPINE, VANCOUVER, NELSON, B. C.

# James Bertram & Son,

LIMITED.

LEITH WALK - EDINBURGH

---

## “LEITH WALK”

### PATENT HALF DRUM STRAINER

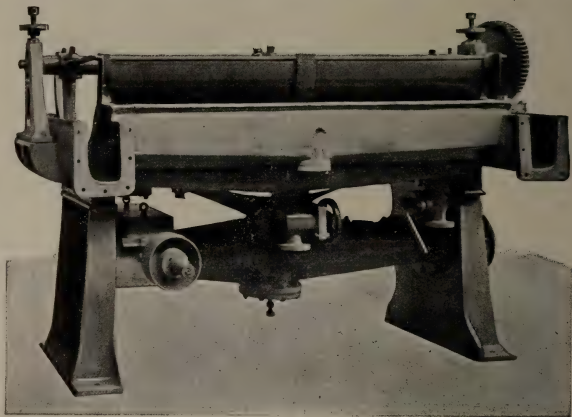

#### *ADVANTAGES :*

- Enclosed Self Lubricating Driving Gear
  - Stroke can be altered whilst Strainer is at work
  - Plates can be cleaned in a few minutes without removal
  - Noiseless in action, with small cost in upkeep
  - Great capacity with upward flow of Pulp
- 

Telegrams : “Bertram, Leith”

# PNEUMATIC

## Save-Alls, Pulp Thickeners and Filters

Remember that we make Special Pneumatic Machinery,  
not only for saving waste from white water but for  
thickening pulp and

*for filtering river water*

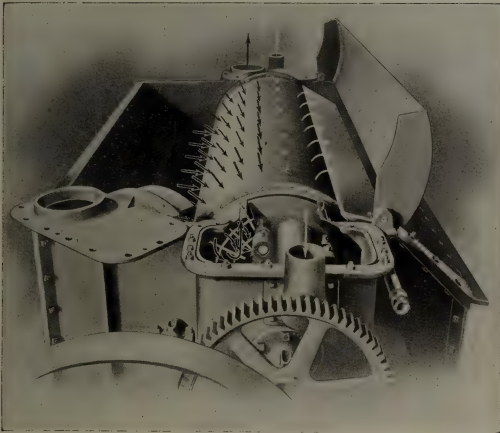

Pneumatic Action of the Save-All

The same pneumatic principle which has made our Pneumatic Save-alls and Pulp thickeners so successful has proved wonderfully effective in our Pneumatic Filter for river water. In this machine we employ an exceedingly fine cylinder-mold facing, through which several million gallons of water per 24 hours can be filtered clean. The clean filtering is due to the minute "mesh" of the covering and the continuous cleansing with air-blast and water-jet; the enormous capacity is due to the pneumatic action; the long life of this Filter is due to the absence of all mechanical wear upon the cylinder.

This machine is filtering clean even in cases where the river is exceptionally dirty because of saw mills located upstream.

*Send for particulars*

---



---

## Sherbrooke Machinery Company

LIMITED

SHERBROOKE

QUEBEC

**RENOLD PATENT SILENT CHAINS**

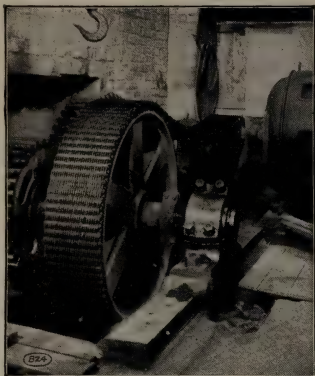

(Drive Stationary)

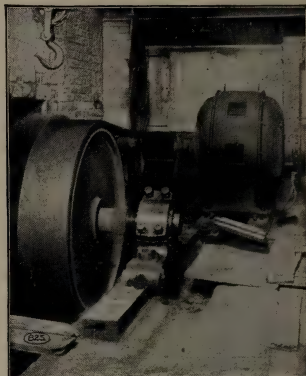

(Chain Speed 1,180 f. p. m.)

150 h.p. Line Shaft Drive

**NOT AFFECTED BY HEAT, VAPOR OR MOISTURE**

We have installed, and in some cases completely equipped, the largest and foremost Pulp and Paper Mills in Canada with the Renold Chains

**JONES & GLASSCO**

ENGINEERS

Registered

SOLE CANADIAN AGENTS

MONTREAL

**Lawrence Machine Co.**

LAWRENCE

MASS.

— MANUFACTURERS OF —

**Lawrence Centrifugal Pumps**

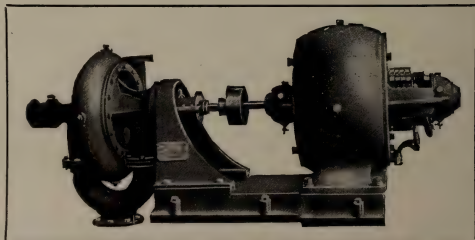

LET US FIGURE ON YOUR REQUIREMENTS



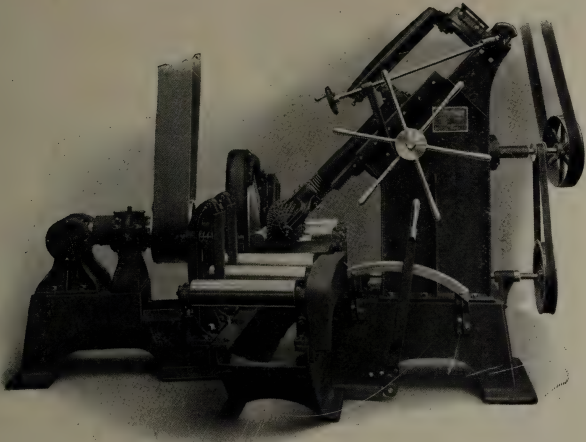

## Are You Aware of the Fact?

That the Robert & Libert Green Bay  
Barker covers every pulp producing  
country in the world.

### Green Bay Barker Co.

GREEN BAY, WIS.

KUUSANKOSRI, FINLAND.



Interior of the  
Machine  
Room of  
Messrs. Ed-  
ward Lloyd,  
Ltd.

Sittingbourne,  
England,  
containing the  
last two  
machines  
supplied to  
this Company  
by Chas.  
Walmsley &  
Co., Ltd.



These "Walmsley" Fast News Machines are 175 inches wide, and are making paper at over 600 feet per minute, with an output of 500 tons news print weekly. The machines are equipped with the Lloyd and Hutchison Patent Drive. This patent device is controlled by Walmsley & Co., Ltd., and dispenses entirely with Friction Clutches and Gear Wheels.

# Charles Walmsley & Co. Ltd.

PAPER MAKERS' ENGINEERS

BURY - England

Head Offices,  
ATLAS WORKS  
WOOD STREET

Codes, WESTERN UNION, A.B.C. 5TH EDITION,  
McNEILL'S 1908

Telegrams, "PUMPS, BURY." Telephone, BURY 499

## SPECIALTIES—

Complete Paper Mill Plants  
Variable Speed Enclosed Steam Engines  
Cone Beaters for News Stock  
Slitting and Re-Reeling Machines  
Beating and Refining Engines  
Super Calenders  
Buffing Machines, etc., etc.

## FOREIGN REPRESENTATIVES

Norway, Sweden and Finland :  
N. A. EIE - Christiania  
Austria, Hungary :  
F. SCHOFFEL, Engineer, Vienne

CANADA :  
C. H. JOHNSON & SONS  
LIMITED  
ST. HENRY, MONTREAL

# Wilson-Paterson Co'y



127 BOARD OF TRADE BLDG., MONTREAL.

Agents for the United Alkali Co. of England

**OFFER TO THE TRADE:**

Caustic Soda 60° to 78° Soda Ash, Caustic Potash, Sal Soda, Silicate of Soda, China Clay, Rosin size and a full line of Rosins, direct shipment from the south.

**Contracts made for regular supplies.**

## PARSONS TRADING COMPANY

*Exporters of Paper to all Parts of the World*

WHITEHALL BLDG., 17 BATTERY PLACE, NEW YORK

BRANCH OFFICES AT

LONDON

SYDNEY

MELBOURNE

WELLINGTON

CAPE TOWN

BOMBAY

HAVANA

MEXICO, D.F.

BUENOS AIRES

**CORRESPONDENCE WITH MILLS SOLICITED**

# THE CARTHAGE CHIPPER

WILL INCREASE YOUR CHIPS. WILL  
DECREASE YOUR SAWDUST. By virtue  
of its Design and its Patent Feed Spout it takes a  
MINIMUM AMOUNT OF POWER.

---

Ask Anglo- Newfoundland Development Co.  
Ask Laurentide Pulp and Paper Company.  
Ask The Riordon Paper Company, Limited.

---

OR WRITE

**CARTHAGE MACHINE CO.**  
**CARTHAGE, N.Y.**

# Pulp and Paper Magazine of Canada

*A Magazine devoted to the interests of Canadian Pulp  
and Paper Manufacturers and the Paper Trade.*

SUBSCRIPTION PRICE; \$2.00 a year. Single Copies, 20 cents.

OFFICE OF PUBLICATION : 226-7 Confederation Life Building, Toronto, Canada

MONTREAL OFFICE : 34.B. Board of Trade Building

---

---

## *A Boost for Western Paper Mills*

---

The decision of the U.S. Treasury to allow the entry of pulp and paper from a certain section of British Columbia free of duty raises some very interesting reflections. One is that, if this decision becomes the basis of a settled policy—and it is difficult to see why what applies to one paper manufacturing company should not apply to another—it will mean a good deal for the development of British Columbia as a paper manufacturing region. There is no question as to the potentialities of the Pacific Province for a profitable carrying on of the industry. It has enormous resources in pulpwood of the finest varieties and qualities, and it has some fine waterpowers. In spite of these advantages, however, though several enterprises have been started, paper manufacturing, with some exceptions, has not been a conspicuous success. For this, the financial arrangements have been partially to blame in some cases, but probably the greatest handicap has been the distance from eastern markets, with consequent heavy transportation charges, and the restrictions against access to the nearer American markets.

The Powell River Company, it seems, an American concern, recognized the possibilities of the situation, with unlimited stores of wood close to the boundary, and it made a proposition to the Provincial authorities to build a large mill if they would remove the restrictions on the wood. This acceded to, it has been apparently an easy matter to convince the American authorities that they could legally allow the free import of paper made from such unrestricted wood.

As British Columbia possesses many other fine tracts of timber lands situate similarly to those of the company mentioned, it is by no means unlikely that the example may be followed by others and that the ice being once broken as described, the Pacific Province may speedily come into its own as a great pulp and paper manufacturing region. It scarcely seems fair to competing mills across the border, but that, we suppose, is the affair of our neighbors, on which it is not necessary for us to say much.

With mills once in profitable operation, however, near our Western coast, it seems to us there will be no



need for them to confine their market to the United States. British Columbia is admirably situated for the supply of Australian and Oriental markets, whose wants are increasing and may be expected to increase more rapidly in the future. Again, with the Panama Canal in operation, it would seem that that Province's opportunities for the manufacture and profitable export of paper should expand enormously, and there is no reason why its development along this line should not equal even that of Quebec, to say nothing of other parts of the Dominion.

### *Pulpwood in the United States*

United States census figures compiled by J. E. Wheelchel, expert special agent, under the direction of W. E. Stewart, chief statistician for manufactures in co-operation with the forest service of the Department of Agriculture, show a steady increase in importance of the pulp manufacturing industry. Consumption for that year by 268 active mills was 4,328,052 cords of pulpwood of all species. This was an increase over 1910, by 272 active mills, of 233,746 cords, or 5.7 per cent.; over 1909, by 253 active mills, of 326,445 cords, or 8.2 per cent.; and over 1908 by 251 active mills, of 981,099 cords, or 29.3 per cent.

Increased consumption for 1911 compared with 1910 was general, nearly all States reporting gains. New York, Maine, and Wisconsin, which, in order named, were the leading producers in both 1910 and 1911, showed increases in the later year over preceding year of 9.6 per cent., 4.2 per cent., and 13.0 per cent. respectively.

Of the total increase in pulpwood consumption in 1911 over 1910, 233,746 cords, nearly 60 per cent. was contributed by spruce alone, the remainder being distributed between

balsam fir, pine, white fir and mill waste. A peculiar feature as to spruce consumption is that the increase in total quantity of this wood reported was confined almost entirely to domestic spruce, imported consumed in 1911 forming 35.9 per cent. of the total as compared with 38 per cent. in 1910.

Because the bulk of increase in pulpwood consumption in 1911 over 1910 was supplied by spruce, the showing for the later year furnishes a marked exception to the tendency during the past few years, of replacing spruce with other cheaper woods. Spruce formed 58.1 per cent. of the total of all woods in 1911, against 58 per cent. in 1910, 60.5 per cent. in 1909 and 64.5 per cent. in 1908.

### *EDITORIAL COMMENT*

F. C. Crean, a Montreal mining Engineer, during a recent trip through Labrador, discovered large deposits of grey moss, similar to what is known as reindeer moss, and he is making experiments on it with a view of discovering whether it would not make a fine material for paper making. It has a long strong, clean fibre, and the reports sound rather favorable.

\* \* \*

A bill is to be introduced in the Massachusetts Legislature to ask for a subsidy to establish a school of paper making in Holyoke. The United States, just as Canada, has suffered from the lack of a sufficient number of men scientifically trained in the making of a good quality of paper at a minimum cost. The founding of a school of this nature is just what is needed to place the industry on the best foundation. A pronounced move in the same direction would do good in Canada.

\* \* \*

The pulp and paper industry have a very vital interest in the great forestry convention being held this

week in Victoria, the capital city of the Pacific Province of British Columbia. The keynote of the science of forestry is conservation; which means, not the keeping of resources out of use, as some have supposed, but the rightful use of the same. Canada's lumber and pulpwood resources, if utilized in this manner, are sufficient for many generations; indeed, they may rightly be looked upon as inexhaustible. Fire and rash wastefulness are the enemies to be fought against. Forestry teaches the best methods for such fighting. There is no true friend of Canada but will be present in spirit at the deliberations of this Association, whose interests are so nation-wide in their scope.

\* \* \*

The Pulp and Paper Magazine has received from an English firm of paper merchants a sample piece of "board" such as is used for wrapping soap or making cereal cartons, with the request that Canadian manufacturers should send quotations for similar material in quantity. Quotations can be made for woodpulp only, or as per sample. The stuff is wanted on the reel of about 3 to 4 ft. diameter. The substance of the board may be reckoned at  $17\frac{1}{2} \times 22\frac{1}{2}$  60 lbs. 600 sheets. Probable quantity required would be 15 to 20 tons per month, and, perhaps, double this quantity, but at least 4 tons per week. A constant stock would have to be kept on hand in Bristol. Width of the reel would be approximately  $9\frac{1}{2}$  inches wide and some would be required in 9-inch and some in the 8-inch width.

\* \* \*

Politicians in the United States, headed, we regret to say, by President Taft, seem to be indifferent about the manner in which they drag the honor of their country in the mire by breaking the Hay-Pauncefote treaty, as soon as its conditions become inconvenient to

them. Because, however, the United States is a Democratic country, this does not mean that its politicians represent the true feelings of its people. Moreover, we refuse to believe that our neighbors will in the end allow themselves to be presented by their legislators in such a poor light in the eyes of other nations. This, we believe, is proven by the manly, honorable way in which better-class Americans and their best journals refuse to countenance the Senate and President's slippery eel-trick in regard to the Panama Canal tolls. Let us not, therefore, blame the American people, but, rather, their political representatives who so miscalculated the sentiment of the nation.

---

#### PULP AND PAPER DIRECTORY OF CANADA.

(From the World's Paper Trade Review.)

Since 1907 the "Pulp and Paper Trade Directory" has made conspicuous progress, and this may not be wondered at when one considers the vast field it covers for information which is of the utmost value in the paper and pulp trade. It is a volume that can be relied upon, and there are several valuable adjuncts to it in the way of Customs tariffs, watermarks and brands, tariff customs, laws relating to pulp wood, and a list of agents, commission merchants, etc. The pulp and timber laws quoted in the directory should be of extreme value to those engaged in the trade. New Brunswick, Nova Scotia, Quebec, and Ontario laws are set out in a convenient style, with all particulars as to dues and measurements. The particulars in regard to paper and pulp mills are also supplied fully, with the names of the most prominent officials included, and the power used, together with the output per diem. Inset here and there through the volume are some attractive samples of paper made in Canada. The "Pulp and Paper Directory of Canada" has become a recognized work, and it reflects credit on the publishers, who have left nothing undone to make it complete and reliable.

## Apparatus for Watermarking Paper

Jas. Speed and Alex. Whitton, of West Springfield, Mass., have invented a device for watermarking paper which, it is claimed, though making use of cylinders does away with the dandy roll. A pair of cylinders is provided which have their location forward of the first one of the dryer drums employed as part of or in conjunction with paper machines so that the web

which are vertically movable to which pressure in a downward direction is imparted, and in conjunction with which boxes are means whereby the downward movements of the lower boxes are limited so that the co-operation cylinders themselves are never brought to circumferential contact, although in every revolution of the upper cylinder its impression carry-

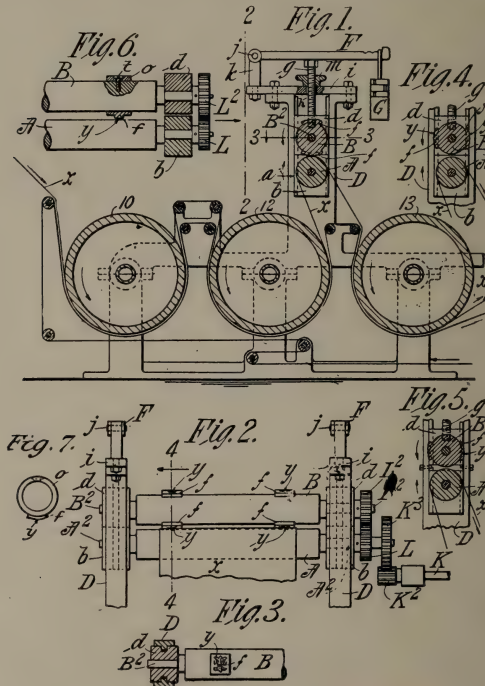

being drawn out from the wet end of the machine and becoming partially dry is subjected, while yet damp, to the paper marking impression of one of a pair of cylinders which has one or more are faced projections extending from the circumferential surface thereof provided on such are face with impression forming surfaces, such cylinder being journaled in boxes

ing projection or projections are brought to pressure bearings against the periphery of the lower cylinder or against the web of paper running thereover.

Fig. 1 shows, in sectional elevation, the first, second and third drums of the dryer apparatus and the arrangements comprised in the present invention combined therewith. Fig. 2 is an elevation as seen

beyond the plane indicated by line 2—2, Fig. 1. Fig. 3 is a partial horizontal sectional view as taken on line 3—3, Fig. 1. Fig. 4 is a partial cross sectional view in detail as taken on the line 4—4, Fig. 2. Fig. 5 is a view in detail showing a slight modification in the construction of the recessed uprights in which the journal boxes are fitted. Fig. 6 shows a roll having interchangeable equipment, and Fig. 7 is a detail view in further illustration thereof.

Nos. 10, 12, and 13 represents the first, second and third dryer drums of the series, the number thereof being greater or less as required; x represents the web of paper understood as being drawn to the rightward from the wet end of the Fourdrinier machine, and carried, by the usual felt apron, for its proper course through the dryer drums, for which, as understood, usual means for rotating them at uniform speed is provided.

The web of paper after passing through one or more of the dryer drums becomes partially dried so that in passing to and through farther of the drums it reaches them in only a damp condition; and we have found it advantageous to locate the watermarking cylinders A and B adjacent and forwardly of the second one, 12, of the drums. The opposite uprights D D are provided adjacent the ends of the second dryer drum, 12, each having a vertical recess a therein.

bb represents a pair of oppositely located boxes for the journals A<sup>2</sup> of the lower cylinder A, the same being stationary by reason of resting on the lower boundary of the vertical recess a.

dd represent a pair of oppositely located boxes for the journals B<sup>2</sup> of the upper cylinder B, which boxes are vertically movable, and have means below them for limitations of their downward movements. Such means, as represented in Figs. 1, 2, and 4, is constituted by the simple expedient of the lower journal boxes on which the upper ones bottom. The upper cylinder has one or more (a pair being here shown) projections f extending from the circumference thereof and provided with arc shaped impression forming faces y produced in any suitable way, as by engraving, or by the processes of electrotyping, stereotyping or otherwise.

The upper boxes d d have upwardly extending stems g which extend for guidance through holes h therefor in the cap pieces or bars i secured on the tops of the upright D and which are provided with head forming enlargements; and coacting with these headed upwardly extending stems g are levers FF, each of which is connected by pivot j at one end to post k upstanding above the cap piece i, and has a weight G suspended from its other end so that according to the size of the weights a greater or less pressure in a downward direction is exerted through the stems g to the upper boxes and to the upper cylinder B.

The cylinders A and B are to be rotated at uniform speed corresponding to the surface speed of the dryer drums 10, 12 and 13, and to the travel of the paper which runs in conjunction therewith; and as a means therefor power is transmitted through the shaft K which has a pinion K<sup>2</sup> thereon which meshes into a gear wheel K<sup>3</sup> on the end of one of the journals A<sup>2</sup> for the lower cylinders; and the journal of the lower cylinder is by gear L affixed thereon meshed into the gear L<sup>2</sup> of the upper cylinder and in constant and running engagement therewith.

In operation, the web coming in a very wet condition from the Fourdrinier machine and carried by the apron to and around one or more of the dryer drums, passes between the cylinders A and B and thence forwardly to the farther dryer cylinder or cylinders. By reason of the arrangement of the journal boxes, and the means for sustaining the upper ones in a limited degree of descent, the web will pass freely through and between the pair of cylinders A and B, but every time one of the arc faced impression bearing projections f comes around adjacent the lower cylinder a, it has a pressure bearing on the paper under the weight of such cylinder and its boxes, and an augmenting pressure is exerted through the stems g by the weighted levers F to produce an impression having all the general aspects of a watermark in the but partially dried web of paper. When each revoluble are faced projection f comes around to its lowermost position and adjacent the lower cylinder, it causes the upper cylinder B,



and its journal boxes dd to have a degree of rising movement so that the impression producing parts are subject to the weighting pressures aforementioned; and then when the arc faced projection has been partially and so far revolved as to move upwardly away from the plane of the traveling paper, the upper cylinder A is permitted to descend in a limited extent, but not so far as to prevent the periphery of the cylinder proper to come to contact against the web. Such limitation of the downward movement of the cylinder is assured by the arrangement of the parts, such as shown and described wherein the boxes dd for the upper cylinder bottom or come to rest upon the tops of the journal boxes bb for the lower cylinder. But as represented in Fig. 5, instead of having an arrangement by which the upper journal boxes bottom against the lower boxes, a horizontal partition is provided across the vertical recesses in the uprights d below which partition the lower boxes are located, and upon which the tops of the upper boxes bottom.

The means hereinabove described for watermarking paper is less expensive than the means constituted by dandy rolls, and is preferable to the employment of dandy rolls for the further reason that it becomes possible to produce watermarking of more elaborate and complex design, and one in which the delineation is formed by marks or impressions which may be more closely related or finer than any possible to produce by the action of a dandy roll.

When it is desired to run the dryers without having the paper passing there-through watermarked, the upper boxes may be elevated by the hand wheel nuts m engaged on the screw threaded portions of the stem g so that the upper boxes and cylinder are slupported to such an extent above the lower cylinder that the revoluble projections f pass around free and clear of the traveling paper. And inasmuch as it is desirable to have the watermarking impressions at different distances apart on the traveling web, we provide, for use in some cases, interchangeable rings, such as shown at o in Fig. 6, which may be slipped on the upper cylinder, which may be of a standard diameter, and secured by set screw t.

In conjunction with the employment of the interchangeable ring having the projection f provided with the arc formed impression producing surface, proper interchangeable gearing to substitute that shown at L, L<sup>2</sup> is provided to secure the propulsion of the cylinders at the proper speeds.

#### WILLIAM D. GREGOR.

William D. Gregor, who has just been appointed superintendent of the Kenogami Paper Mills, Jonquiere, Que., is a Scotchman by birth, having been born in St. Andrews in 1874. He started his paper making career with R. Sullis & Co., Markinch, Fife, Scotland, and went with them through the various departments up to backtending on machine. After three years in Dalmore in a more or less similar capacity he went to the Guardbridge Paper Co., Fife, and enjoyed for over six years, perhaps the most useful experience to be obtained anywhere. Eight years ago he came to the United States, where his career was quite successful, being appointed after a year's service with the Oxford mill at Rumford, Me., under Hugh J. Chisholm, whose energy made that mill second to none, superintendent of the paper manufacturing department. During this period the capacity of that mill was increased by the addition of four paper machines, increasing it from 80 to 155 tons per day of magazine, card, litho, table, writing and high grade book papers. After four years he was advanced to the position of general superintendent of the entire plant, making 90 tons bleached sulphite, 112 tons bleached soda pulp, and 155 tons of paper per day. Mr. Gregor's many friends wish him all success in his new appointment.

Satisfactory progress is being made on the new buildings of the Ontario Paper Co. at Thorold, Ont. The grinder room is 130 by 58 ft., mixing and screen room 130 by 92 ft., machine room 265 by 95 ft. The company will use power from Niagara Falls, making its own pulp. Two newspaper machines will be installed. Warren Curtis, Jr., is manager, and John J. Ryan superintendent.



## Development of the Sulphite Industry

E. Spiro, in a recent lecture before the Austro-Hungarian Cellulose and Paper Stuff Association, gave an interesting resume of the beginnings and progress of the sulphite pulp industry, from which we take the following:

B. Tilghmann, of America, took out an English patent in 1866 for a process of obtaining cellulose from wood. The essential feature of his method was boiling the wood with solutions of bisulphites of the alkalis or alkaline earths. Tilghmann's patent was a failure, and it was not till more than ten years later that Mitscherlich, Kellner, and Ekman put the manufacture of sulphite pulp on a commercial basis.

The manufacture of sulphite pulps consists of four stages:

1. The mechanical preparation of the wood.
2. The preparation of the lyes.
3. The boiling.
4. The breaking up of the boiled wood, and the rinsing, sorting and drying of the separated fibres.

In the time of Mitscherlich the knots were drilled out and the wood was then cut up with circular saws into lengths of about an inch and a quarter. This procedure had several disadvantages. It was expensive and tedious, and like every other process involving the use of the circular saw, very dangerous to the workpeople. Accidents were constantly occurring. Again, the thick discs of wood required long boiling in very strong lye. Against all this, however, we have the fact that the cellulose obtained was stronger than has since been got by more modern processes. The sawdust was boiled up with the discs for economy's sake, and inevitably contained portions of the knots. These impurities caused numerous dark specks in the finished pulp. Dark specks also often appeared in the pulp for another reason. The high temperature prevailing during the boiling under a pressure of several atmospheres reached the interior of the discs before the lye and actually charred the still dry wood.

Cutting the discs thinner was, of course, a remedy, but involved the expenditure of more money and time in the saw-mill.

Ritter, Kellner, Ekman, Flodquist, and Francke used revolving chopping machines, and so reduced the waste that it could be neglected, and did not have to be boiled up with the lye. When the saw-mill was used, so much sawdust was produced that it was imperative to work it into cellulose as well as the discs.

Kellner was the first to see that the wood had to be divided into smaller pieces. Hence he originated the application of a grinding process to the chips. His grinding apparatus consisted of a series of conical cast-iron grinders revolving on a vertical axle. These grinders were ribbed, as was the interior of the chamber in which they revolved. The chamber was, of course, provided with a hopper above for feeding in the chips and with an outlet below for the ground stuff. The wood was divided in this mill parallel to the direction of the fibre, and the previous removal of the knots was supposed to be avoided. As a matter of fact, the reverse was the case. The grinding simply broke up the knots so small that the impurities were widely distributed through the pulp. He was therefore obliged to return to the method of removing the knots before grinding. This he did with special machines, comprising very small circular saws revolving at a very high speed. At the same time, he found that a specially constructed chopping machine was necessary to get pieces small enough to be properly ground in the mill.

The use of this machinery was found to entail considerable danger to the workmen, with its attendant consequences of actions for damages and demands for higher wages. Hence the introduction of the centrifugal mill with an axle armed by steel spikes revolving in a chamber from the inner walls of which similar spikes project. Even with the mills it was impossible to prevent the occurrence of knot debris in the pulp, and this had to be sorted out by perforated drums, similar to those used for sorting broken stone. These imperfections have led to the introduction of the present roller-disintegrators. Another application of the centrifugal principle is in sorting the chips. If the chopped wood is centrifuged in a suit-

able machine, the heaviest and largest pieces are separated from the lightest and smallest fragments.

Mitscherlich's tower-plant, although it has been altered in details, is still largely used. His original towers were built up of casks with the heads and bottoms knocked out. They are now usually made of granite.

The sulphurous acid is made by roasting iron pyrites in ovens such as are used in the manufacture of sulphuric acid. The hot gases pass from the ovens through brick channels into cast-iron pipes, which lead them into a set of vertical pipes, having about two-thirds of the height of the tower. From this set they travel downwards through another set of vertical pipes of the same height, so that they enter the tower at the bottom. The object of passing the gases through the two sets of vertical pipes is to cool them, and also to increase the current passing into the tower. The descent of the cooler gases in the second set of vertical pipes exerts a kind of suction which draws the hotter gases up the pipes of the first set. At the same time the current of gas varies with the weather, being quicker in cold weather than in hot, and slower with a high than with a low barometer. The tower itself is, of course, filled with limestone to absorb the sulphur dioxide and form the bisulphite for the treatment of the wood. This is delivered in the form of solution ready for use at the bottom of the tower, water being continually sprinkled over the carbonate of lime from the top of the tower.

Kellner's attempts at improving this plant were not very successful. They were directed chiefly to making the working of the tower uniform, or, in other words, independent of those atmospheric influences just mentioned. The only practical result took the shape of introducing intermittent artificial draught, used, of course, when the atmospheric conditions were adverse to the free passage of the gases. Another idea of his was to substitute, for the single lofty Mitscherlich tower, several lower ones. In this type of plant the water is supplied to the last tower only, and the weak lye from the bottom of it is pumped to the top of the last tower but one. It arrives at the bottom rather stronger, and is straightway pumped to the top of the last tower but

two, and so on. This necessarily demands several acid-resisting pumps and much power. The system is, however, in use where local circumstances forbid the erection of lofty towers.

#### ROSIN IN SULPHITE FIBRE.

It has been found in experiments recently made in Germany that the rosin which clings to the fibres of freshly boiled wood pulp differs only very slightly in its chemical behavior from the rosin of the original wood. On the other hand, the rosin which passes away in the waste liquors is profoundly changed in character. The so called "kollergang rosin," which adheres to the sides and scrapers of the kollergang, when the pulp is broken in, was also examined. This sticky mass was found to contain about 19 per cent. of a rosin in combination with sulphur, the remainder consisted of fibres and mineral matter. The kollergang rosin was altered in character just as profoundly as the rosin in the waste lyes. The quantity of rosin which passes away in the lyes is only very small, almost the whole of the rosin of the wood remains in the pulp. When the raw wood was stored for a long time before boiling a portion of the rosin contained in it was changed by oxidation. This is the reason why dry stored wood behaves differently from fresh wood in the manufacture of sulphite pulp. It has been proposed to avoid the trouble of rosin specks in the paper by causing the wood chips to be stored on the mill floor for some time before boiling. The method was found to be impracticable on account of the amount of space required for such storage. Still it is worth considering whether the chips could be treated with a current of air from a ventilating fan as they lie in the hoppers, and thus the oxidation of the rosin might be brought about in a comparatively short time.

Last month through a number of minor accidents on the Welland Canal, the pulp and paper mills depending upon it for their water power were subjected to inconvenience.

## Use of Basalt Lava Stone in Paper Manufacture

*T. Hadfield in Paper Making*

Basalt stone has for some time formed the chief structure of the beating rolls, bedplates, and koller-gangs of most of the beating engines and edgerunners installed in modern paper mills, but the important and economical work which they accomplish is not generally known.

Wherever a new paper mill has been built, or an old one renovated, beating engines are generally installed that are fitted with a stone roll and bedplate, and in some cases the beating engines supplied are fitted with two beating rolls and two bedplates, one fitted with steel plates and the other basalt stone, whereby the half-stuff for any particular kind of paper can be so beaten as to procure the best results in the same beating engine. Both rolls being independently adjustable, the steel knives cut the fibres to the desired length, and the stone so bruises the fibres as to impart the necessary qualities to the finished paper. For filter, blotting and novel papers the steel knives are sufficient, as the half-stuff requires to be quickly cut up, in order to produce a light and bulky paper, but even in this case five minutes' beating with the stone roll gently down would give the paper increased value in comparison with the same qualities of paper otherwise prepared.

Beating engines fitted with two rolls have a further advantage in meeting the difference in the greasiness of the pulp (soda, sulphite, or sulphate), as even the most reliable pulp makers do not always supply exactly similar pulp. In fact, the beaters with two rolls allow of a mixing suitable for the most varied qualities of paper. The construction of the stone-beating roll is such that the metal parts are all covered with cement, so that no metallic impurities can get into the paper.

Stone rolls can be fitted into the existing bearings of any type of beating engine, as all the rolls are supplied with a steel shaft. The segments are inserted by means of a patented method in the cast-iron cone of the beating roll. The construction is perfect,

being solid and firm, and these advantages allow the use of basalt stone in dimensions in which the stone can be obtained and inserted without a flaw, and of uniform texture. It further allows the segments to be replaced when they are worn out. The wear and tear of these segments is infinitesimal, as from practical observation there are a large number of stone rolls in use for several years which have been during the whole time working satisfactorily, and without having their segments renewed. In fact the rolls are very little different in all respects as when new. It is only necessary to retrim from time to time, the segments as well as the bedplates, and this work can be carried out in a few hours by an ordinary stonemason.

The wear and tear of the stone bedplates is no greater than the wear of bronze or steel bedplates, whilst the cost for renewal and fixing is considerably less. The stone for the bedplates is usually taken of a somewhat softer texture than the stone for the rolls, so that most of the wear falls on the bedplates, of which two are always supplied, one to serve as a reserve, so that one can be retrimmed whilst the other is at work. This ensures no loss of time for beating purposes. The beating surfaces of the stone are specially arranged in groups, thus ensuring perfect beating and circulation. Beating engines fitted with steel or bronze plates have in some cases insufficient space between the clumps, and this defect causes imperfect beating and circulation. The following papers, given their special half-stuffs, sizing, loading, etc., can be beaten in a beating engine fitted with stone roll and bedplate, and the finished paper will be found more perfect, and endowed with special qualities: Kraft, packing papers, greaseproofs, imitation parchment, news, insulation, and various kinds of printing papers. This process of beating can be so adapted as to produce a very transparent paper. For very opaque papers, and where the stuff is required very "free," the steel knives would be an advantage.

For papers such as imitation parchment and grease-proofs the stone roll and bedplate are unique, as they prepare the stuff in less than half the time, and, given perfect manipulation on the machine, the finished paper is far superior to that beaten with steel knives, and the cost of production is much less, especially when the amount of horsepower consumed under both systems is taken into account. No matter how the steel knives are manipulated they are forced to cut the fibres to a certain extent, whereas steel rolls and bedplates draw out and separate the ultimate fibres. More output is derived from the same number of beating engines with stone rolls than steel rolls; as a matter of fact, in some cases the output is double. A battery of beating engines giving an output of 100 tons per week with steel plates could be increased to 180 tons per week with stone rolls. The most important facts in reference to basalt stone rolls and bedplates are:

1. During beating most of the fibres are flattened out, whilst the smaller ones are rubbed to pieces, thereby helping to make a sheet of paper uniform in texture and strength.

2. The beating process is so conducted that less size is required, and at the same time imparting ink-resisting qualities to the finished paper.

3. Stone rolls can be used with greater freedom without spoiling or discoloring the pulp—this refers to dyed or undyed papers where iron would cause irregular colored specks in the paper.

4. By careful attention to the shake of the wire, the strength of the paper in the machine and cross direction is more uniform, and the paper possesses greater resistance against tearing.

5. Taking into consideration the time for heating, the horsepower consumed is considerably less and the circulation is more perfect (taking two beating engines of the same make, one fitted with stone and the other with steel plates).

6. The stone is not affected by acids or alkalies, and metallic impurities cannot get into the paper by the beating process.

7. The beating capacity of the mill is greatly increased.

8. Less expensive half-stuff could be used (under practical supervision) and yet pro-

duce a paper equally as strong as a pulp beaten with steel plates and more expensive half-stuff.

The best kraft papers are produced by blending together the special kind of wood pulp (soda and sulphate) which has undergone a special process in their preparation. The pulp as it arrives at the mill is first steamed in a revolving boiler for two hours and then broken up into the kollergang. Edgerunners used in the best kraft mills consist of basalt stone, giving excellent results as, contrary to sandstone or granite, the runners never require re-sharpening, since the porosity of the stone, combined with its hardness, always causes it to retain an excellent surface.

There are generally six edgerunners for a two-machine mill making kraft, and the pulp from the edgerunners is automatically conveyed to the beating engine, where the pulp is given the necessary treatment with stone rolls and bedplates. The pulp is sized with resin, and ochres or other earth colors give the pulp the desired shade. If the pulp, as it flows on to the wire, has been perfectly prepared, the machineman so arranges the wire, suction boxes, presses, and the heat in the drying cylinders, that a first-class kraft paper is produced. There is an apparatus connected with the breast roll on up-to-date machines, so that the wire can be raised or lowered instantly, and in the manipulation of this apparatus lies the nucleus for making a perfect kraft, combined with a narrow vacuum box drawing slightly a short distance from the breast roll. For the manufacture of the various class of papers specialized in reference to basalt rolls and bedplates, it is an acknowledged fact that the firms who have them installed, either by themselves or in conjunction with a roll and bedplate fitted with steel knives, produce better and more perfect paper, coupled with mutual benefit to the seller and the buyer of the finished product.

Most managers seem to realize the fact that beating is the most important stage in the manufacture of paper, and the preparation of the stuff depends upon a beating engine in which the whole of its mechanism is perfect. The preparation of the stuff depends also upon the skill of the beaterman; a good man will easily produce better results even with slightly inferior half-stuff



than an indifferent man with everything in his favor except skill and knowledge of beating, on which the physical constants such as weight, strength, bulk, opacity, resistance to wear and tear, and other qualities depend.

### THE CURLING OF PAPER.

One of the principal causes of curly paper is excessive wetness in the beating of the stuff. Free-beaten stuff is far less subject to this defect than wet-beaten stock. A paper which does not contain much loading is also more liable to curl than a heavily loaded paper. The trouble of curling is most frequently met with in the case of body papers for coating purposes, "enamplings" or "colorings." These require very special experience in their preparation and frequently entire makings have to be rejected on account of the trouble through curling.

In the first place care must be taken in the selection of the raw material. All kinds of hard woodpulp are quite unsuitable unless they are blended with other very soft materials. Even when quite soft, rags are mixed in, care must be exercised in the beating if a non-curling coating paper is to be made. The beating tackle should preferably be sharp, for although it is possible to prepare a good coating paper with blunt tackle, such means involve far more care and experience on the part of the beaterman than if the beater be adapted to the purpose in view. The writer has even seen good coating paper beaten with a stone roll; the paper was quite satisfactory as regards not curling, but left something to be desired as regards the look-through. However, when the next making came along, although the previous prescription was apparently closely followed, the paper could not be got through the coating machine at all. Some slight variation in the lowering of the roll had made the stuff too wet. These papers, moreover, are required to have a fine close look-through, and this can only be obtained by milling the stuff rather short. In starting from a hard long-fibred material, beating has to be continued for a longer time or the roll pressed harder down.

In order to test whether a paper is likely to give trouble through curling, a strip is

cut from the direction along the web and moistened slightly on one side. If the strip curls to a semi-circle there is danger that the paper will not give satisfaction to the paper coater. A suitable paper should only show a slight tendency to curl towards the dry side when the strip is damped on one side. The addition of 15 to 20 per cent. of cotton pulp to the furnish will generally be sufficient to overcome an undue tendency to curling.

With papers containing mechanical pulp the danger of curling is not nearly so great as with better papers, because the stiff wood fibres are not subject to curl, but even some wallpapers containing mechanical may show this trouble if they are made too hard and contain a large proportion of sulphite pulp. Unbleached wood cellulose is worse in regard to curling than the bleached; straw pulp is quite unsuitable, the hardness of the paper and the shortness of the fiber both giving a tendency to curl. As regards the beating of these papers, it is impossible to give definite prescriptions as to time, because it all depends on the design of the beater and the sharpness of the knives; a good general rule is to get the correct degree of beating done in as short a time as possible.

The sizing also plays a part in the question of curling, very hard-sized papers tend to curl more readily than three-quarter-sized papers. It is, therefore, advisable to keep the sizing rather low, but in this connection it is necessary to bear in mind the purpose to which the paper is to be put; some papers must be hard-sized for other reasons.—*Wochenblatt fur Papierfabrikation.*

The Finch Pruyn Co. will erect a large pulp and paper mill at St. Flavian, Que.

The new plant of the Lake Superior Co. at Sault Ste Marie, Ont., is proving very satisfactory. The first two paper machines are now working well and are turning out some seventy tons of commercial paper a day—an output nearly up to the full capacity of the two machines. The sulphite mill is running smoothly, and the management is said to be very pleased with the way in which the new equipment is working.



## Jack Pine and Hemlock for Mechanical Pulp\*

*Continued from last issue*

Much importance is attached to the amount of pulp obtained from a cord of wood, because this represents the efficiency of conversion. Commercial practice in the manufacture of spruce ground wood requires a yield of approximately 2,300

conversion has been found to range between 12 and 15 per cent. of the original weight of the bone-dry wood. Approximately 6 per cent. can be accounted for in the white water and 1 per cent. in screenings. The manner in which the re-

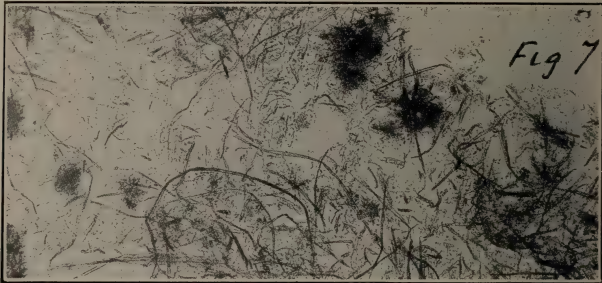

pounds per cord of rossed wood, or 1,800 pounds per cord of rough wood.

One hundred cubic feet of solid wood was selected as the basis of yield, since it eliminates the variable loss in barking, and represents fairly well the amount of solid wood in a rossed cord. The yield, as will be seen, is directly proportional to the

maining losses occur has not been determined, but will be studied in future tests.

The storage capacity for white water in the laboratory was very limited, and this may to some extent account for the low yields. The continuous use of the white water and the use of save-alls would undoubtedly tend to increase the yields and

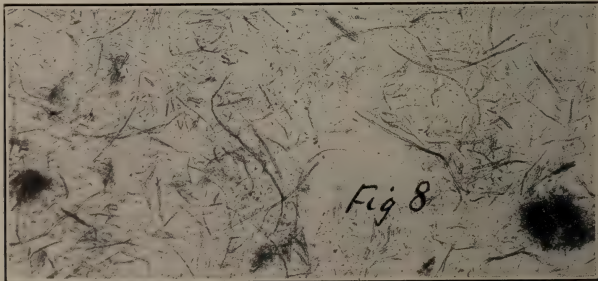

bone-dry weight of the wood. The loss in

result in saving a great deal of fine pulp.

\*—Abstract of report by J. H. Thickens, Chem. Eng. in Forest Products, Forest Service, U. S. Dept. of Agriculture.

The loss in barking jack pine and hemlock, so far as has been determined up to the present time, is practically the same as the loss in the barking of spruce. There

are a great many knots in both hemlock and jack pine, and it is possible that this may cause a somewhat greater loss in barking these species. However, on account of the small amounts of the various woods used, no reliable data on loss were obtained.

#### Factors Which Influence Quality and Production. Speed and Pressure.

The effect of speed on the quality of pulp can best be illustrated by the magnified fibres shown in Figs. 7 to 10. In grinding these pulps the pressure and surface of the stone were maintained constant, and the speeds were, respectively 100, 150, and 200 revolutions per minute for the hemlock, and 152 and 205 revolutions for the jack pine. There is little difference in the fibres ground under these

which these results were obtained are considerably lower than those ordinarily employed commercially, and the results have little significance. If the stone is what is ordinarily called sharp, it is necessary to use a lower pressure, and when dull, a higher one, but it is impossible to obtain the same quality of pulp under both conditions. Speed and pressure affect quantity rather than quality, and by the proper adjustment of both the maximum efficiency of grinding is attained. If a certain speed is selected there must be a corresponding pressure which will yield the greatest amount of pulp in 24 hours with the least consumption of power.

By the term "constant pressure," wherever used in this report, is meant constant pressure on the grinder cylinders. The pressure per square inch of wood in

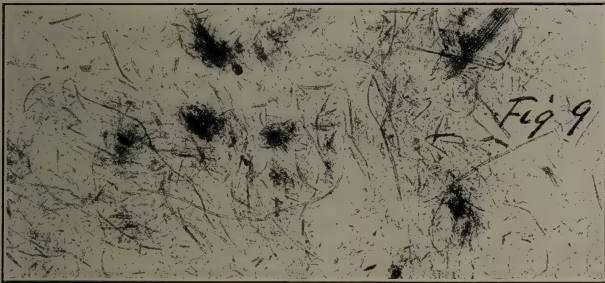

different conditions of speed; especially those run at 150 and 200 revolutions per minute. Speed probably has very little effect on the quality of pulp. With satisfactory pressure and surface of stone, it is possible to obtain good grades of pulp at any speeds within reasonable limits. Commercially, it is practically impossible to maintain the speed constant at all times. When the pressure on a pocket is removed the speed is bound to rise considerably, especially when the water wheels or turbines are operated without a governor.

When hemlock wood was ground at low speed and low pressure it was impossible to obtain anything more than a powder. Also when this wood was ground at low pressure and high speed the product was extremely short, but the pressures at

contact with the grinding surface varies considerably, chiefly with the size of wood ground and the area of the pocket. Again, the length of the wood is not at all a constant quantity, and this, too, can only result in a variable pressure per square inch of wood. The pressure of the wood on the stone varies throughout certain limits with any pressure on the grinder cylinder, and the ranges of pressure of the wood on the stone are raised or lowered by raising or lowering the cylinder pressure. This pressure variation, however, can hardly be controlled commercially, and therefore has not been considered in the tests discussed in this report. There is also more or less pressure variation due to binding of wood in the pockets, and this, too, is difficult, if not impossible, to control. Figure 1 shows a measure of the power

applied to the grinder. The effect of pocket binding and the withdrawal of pressure from one of the pockets will be noted. At one end of this chart the power consumed is approximately 360 kilowatts, falling off gradually to 280 kilowatts, due to pocket binding. After raising the pistons and readjusting the wood in the different pockets, the power to the grinder motor had to be increased to 350 kilowatts on account of the added load produced by eliminating the pocket binding.

#### Surface of Stone.

The most efficient grinding condition is one where there is a maximum amount of grinding surface, and still a sufficient amount of depression in the stone to allow for the carrying away of the ground wood, or, as this is commonly called, for the clearing of the stone.

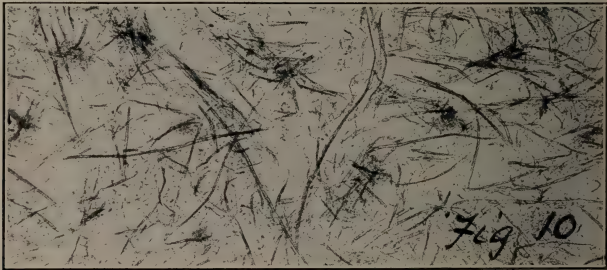

Throughout the experiments, particularly the commercial tests, it was found that the pulp of same appearance as regards fiber and of the same apparent strength can be obtained by using burrs of widely different design and fineness of cut, provided the grit of the stone is in each case the same. For example, during the commercial tests the stone was burred at different times with different types of burrs, and the grinding in each case was found to require the consumption of the same amount of power. The production per day was the same also, provided the grit was brought to the same condition of sharpness and the other variables were kept constant.

During some of the preliminary tests the surface of stone was dulled with a fire

brick, as is often done in mills. This appears to have been unnecessary; in fact, the result is detrimental rather than beneficial.

Better pulp was obtained and the production was increased slightly by crushing the tops of the ridges formed in burring by means of a solid, smooth bush roll. This method does not smooth off the individual particles of sand on the stone as dulling with the brick does, but rather sharpens them. During the tests conducted on mixed woods a surface obtained by the use of a three-to-the-inch straight-cut solid burr and a 12-cut spiral burr was used. The stone was first dressed with a three-to-the-inch burr, forming grooves in the stone approximately one thirty-second inch deep; then the portion of the stone between these depressions was roughed with a 12-cut spiral burr. This caused the

grit to stand out and gave a maximum of useful grinding surface. The pulp obtained with this surface was almost entirely free from shives, and the fibres were long and fine.

A great deal of experimentation still remains to be done, not only with burrs of different cut and design, but more especially with stones of different grits, since it appears that the grit is more responsible for the quality of pulp obtained than any other variable feature in its production.

Where the pulp stone is deep burred, however, the grit is not so important a factor of quality. When the power consumed in making a ton of bone-dry pulp is as low as 50 to 60 horsepower, the added production which must be secured

to bring the power to this low value is obtained through the action of the ridges on the stone and not through the grit. When it is desired to manufacture a pulp of high quality, however, it is the grit of the stone and the manner of raising it which must be considered. The type of burr used and the depth of dressing both influence production, but it is only the latter that influences the quality. When the pulp stone has been dressed so as to provide just sufficient depression to carry away the ground wood a high-grade pulp will be produced, providing the grit of the stone is suitable, irrespective of the style of the burr and within reasonable limits of the pressure used. It is not impossible to conceive of an artificial stone which

nitely what particular advantages or disadvantages, if any, lie in the hot grinding process.

#### Undetermined Factors.

Since the experimental work on hemlock, jack pine, and spruce was started a number of factors which more or less influence the quality and the rate of production of pulp have made themselves evident. These are the rate of growth of the wood, moisture content of the wood, size of wood ground, temperature of grinding, the thickness of stock in the grinder pit, and the grit of the pulp stone, the last undoubtedly being the most important. All of these variables will be studied in future experiments, though the grit of the pulp stone is the one which will probably

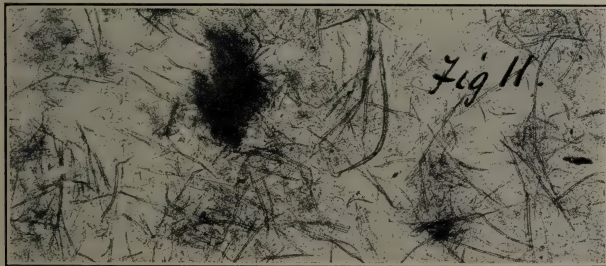

could be used continually without burring, which would clear itself without having depressions or ridges, and which would have the correct size and kind of grit to give the maximum production and best quality.

#### Temperature.

The temperature of grinding, it is said, has much to do with the quality and quantity of pulp obtained, and many manufacturers insist that it is impossible to secure a tough, strong fiber with anything but the hot grinding process. It was noted in the experiments that the rate of production was not nearly as great at a low temperature as it was after a high one was reached. However, it was impossible to detect microscopically any difference in the fibers themselves. As has been said, the only observations made on cold grinding were while the stone was warming up, and on this account it is impossible to say defi-

nitely whether this very important item in the production of ground wood has been given sufficient consideration by manufacturers.

In connection with the reorganization of the Toronto Paper Manufacturing Co., with an increase in capital, referred to under "New Incorporations," the Barber interests have been purchased by outside interests. The places of J. R. Barber, the veteran paper maker; Capt. R. R. Barber, his son, and Peleg Howland on the directorate are taken by G. P. Grant, president of the Dominion Bond Co., Toronto; R. A. Lyon, Toronto, and T. H. Watson, Toronto. Stanley Mann, of Toronto, is also interested. It is understood that the basis of negotiations for the stock was around 175.



## Tests for Paper Sizes

The following are the chief tests for paper sizes, as compiled by a German chemist:

### 1. Iodine Test.

Albuminous bodies, which include animal glues, give with iodine solution either direct or, on souring with acetic acid, yellow or brown colorations or precipitates. The iodine solution is made by dissolving as much iodine in a one per cent. solution of potassium iodide as possible. The reaction must be observed not only with the sized fibre, but with an aqueous extract of the paper. If some of the paper, teased out with a needle on the slide, is dabbed with the solution, a brown color is produced, whether the sizing is rosin or animal. If, however, the paper is heated on the slide with a little water, and then removed, the dried residue on the slide shows characteristic appearances under the microscope and even under a good hand lense.

Animal-sized paper leaves behind a considerable structureless residue extending over the whole surface formerly occupied by the water. The iodine solution gradually dissolves it with a rusty red color. On the other hand, rosin-sized paper leaves but little residue, and that shows a grainy structure with an irregularity dented edge round the space formerly taken up on the slide by the watery solution. This residue also gives a brown color with the iodine solution. It consists of free resinic acid, melted out by the hot water, and forming an irregular deposit against the dry part of the glass.

### 2. Nitric Acid Test.

On heating with strong nitric acid, and especially on after treatment with ammonia, albuminoid bodies give a more or less pronounced yellow color. This is the so-called Xantho proteine resation. Many rosins and alkaloïds give a similar result. The test is applied as follows:

A small piece of the paper is treated on the microscope slide with strong nitric acid, carefully dried, and then treated with ammonia. If the paper was sized with animal size, the yellow will be deeper. The difference is small, but with practice it

can be safely used to distinguish between animal and vegetable size.

### 3. The Million Test.

When warmed with this reagent (a solution of mercuric nitrate containing nitrous acid) all albuminous bodies, and, therefore, animal size, are colored red, from a light pink to a deep brick red. The reagent is best prepared shortly before use by dissolving one cubic centimetre of mercury in 9 c.c. of nitric acid of 1.52 S.G., and diluting the solution with 10 c.c. of distilled water. The use of it is as follows: To a few drops of it in a watch-glass add just the smallest possible fragment of sodium nitrite, to ensure the presence of enough nitrous acid. A drop is then transferred by means of a glass rod from the watch-glass on to a scrap of the paper to be tested on the slide, which is then carefully heated. In the presence of albuminous bodies, the paper turns red, the shade being pale or dark according to the amount of size present. The red soon changes, however, to a dirty brown, and if the Millon reagent is not fresh, the characteristic pinks and reds may be lost altogether. This yellowish brown is the only color produced by the reagent in the case of rosin-size. This test, too, is only reliable in experienced hands.

### 4. The Kiliani Test.

This consists in heating with yellow mercuric oxide until the mercury is reduced to the metallic state. The reducing power of animal size is greater than that of vegetable size, but the test, much boomed at one time, has proved valueless, and is mentioned here only by way of warning.

### 5. The Raspail Test.

This depends on the fact that proteids, rosins, fats, etc., turn rose-colored or violet under the action of concentrated sulphuric acid, and a littel strong cane sugar syrup. Animal size shows the reaction much weaker than rosin-size, so that the reaction only comes into question for the recognition of the latter. The test can only be carried out satisfactorily under the microscope.



The procedure is to damp a little scrap of paper with the sugar solution, put it on the slide, free it from excess of sugar by lightly pressing blotting paper on it, and then to add the strong sulphuric acid when the paper is already under observation with a low power. In this case nothing much will be seen if the sizing is animal, but with rosin sizing deep red color will appear at the parts of the paper attacked by the acid.

#### 6. The Biuret Test.

Albuminous bodies treated first with caustic potash lye, and then with solution of sulphate of copper, give colorations of red and violet. The value of this test consists in the fact that it gives a fully negative result with rosin size. This test is also best tried under the microscope. A little bit of the paper is wetted on the slide with caustic potash lye of about 10-15 deg. B., and after a minute or two has been given to enable the caustic alkali to dissolve the size, one drop of a two per cent. solution of copper sulphate is added from the end of a glass rod. The violet shows best in the fibre after the slide has been drained by setting it on edge.

#### 7. The Adamkiewicz Test.

If albuminous bodies are warmed with a mixture of two parts of glacial acetic acid and one of concentrated sulphuric acid, many of them give a strong red or violet coloration. Casein shows this reaction, animal size does not. This test can only be applied to an extract made from the paper with dilute caustic potash. The paper is wetted with the lye on the slide, and then removed with a needle. The remaining liquid is made acid with acetic acid, and warmed to coagulate the casein. This is then washed by alternate moistening with water, and pressing with filter paper. It then gives the color with the mixed acids.

#### 8. The Tannin Test.

Tannin precipitates animal size. If a piece of paper is wetted and stuck on the slide, and warmed, the paper being then removed, and tannin solution added to the aqueous extract left on the slide. No precipitate is caused if the size was rosin, but

a voluminous brown deposit easily watched as it appears through the microscope is formed in the case of animal size.

#### 9. Extraction Test.

This depends on extracting rosin from the paper with solvents that will not dissolve animal sizes, but like the Kiliani test, it has failed so completely that it merely needs mention.

The tests should be carried out on the stage of the microscope whenever possible, so that colors and precipitates can be observed as they form. The colors are very fugitive, especially under the strong light from the mirror below the stage. If the presence of both sorts of size is suspected, care must be taken to test for them on different portions of the paper.

### GRAND FALLS, N.B., PULP MILL.

The merger of the Grand Falls Power Co., and the Grand Falls Water Power & Boom Co., St. John, now definitely announced, under the name of the Grand Falls Company, Ltd., means a good deal for the province of New Brunswick. Sir Wm. Van Horne and H. S. Holt, of Montreal, are among the Canadians identified with the project while there are also several American millionaires interested. Now that the great water power has been rescued from purely speculative manipulation, the plans for building a large pulp and paper manufacturing plant at an estimated cost of over \$7,000,000, as well as several other industries under contemplation can go ahead. Two hydraulic engineers are already engaged on drawing up plans for the waterpower development and pulp plant, and it is understood that progress on the complete work will go on as rapidly as possible.

The Standard Chemical Co., Toronto, will erect a big pulp and paper mill at McLeod, Alta.

New Ontario Colonization Co., Ltd., Toronto; capital, \$1,250,000. To purchase land, do business as lumbermen and newspaper publishers, manufacture pulp and paper, etc. Alf. Bicknell and H. E. McKittrick, solicitors, Toronto.

## Recovery of Pulp from Waste Newsprint

A large, if not the largest, part of all paper produced, is used for printing of daily newspapers and cheap periodicals, circulars, etc., and is thereby converted in to waste almost before the ink of the printing has dried thereon. The very large demand for these grades of paper, and the growing scarcity of wood, press the necessity to recover the pulp from such waste papers in a condition suitable for using it for the manufacture of the same grade of print papers. This could not be done heretofore, owing to the circumstance that the solvent agents, specified in the various processes heretofore known for the recovery of pulp from waste papers, produce a marked discoloration of the fibres of the "mechanical" woodpulp (ground wood) which is quite largely used as substitute for the chemical pulp in the manufacture of so called newsprint and of other cheap grades of print paper; these processes and the solvents specified therein, cannot be used for the recovery of pulp from such waste newsprint papers and other grades of paper containing a proportion of such mechanical woodpulp.

There are, however, some kinds or makes of such newsprint and of other, similar grades of paper, requiring to be boiled in the solvent solution or subjected to its action under a high temperature, to dissolve the sizing, or to effect a complete dissociation of the pulp fibres therefrom; such a treatment of the waste papers is also sometimes required to completely dissolve the adhesive ingredients of the printers' ink, and to enable the carbon, or other pigment, to be separated from the pulp fibres and to be removed by washing.

The object of a recent invention by J. M. Burby, of Astoria, N.Y., is to devise a process for the recovery of pulp fibres from waste papers containing a proportion of mechanical woodpulp (ground wood) in which process such waste papers may be boiled in the solvent solution or subjected to its action at a high temperature, without producing the discoloring and other detrimental effects upon the fibres of this mechanical woodpulp. This object is attained, he claims, by employing, for

the treatment of such waste papers, a solution of borax, and the process is based upon his discovery that borax is a solution does not produce a discoloration of the fibres of the mechanical woodpulp, and does not perceptibly affect their other physical properties, when such waste papers are subjected to its action at high temperatures, or are boiled therein, or even if the borax solution be stronger than required to dissolve or saponify the adhesive ingredients of printers' ink and the cohesive ingredients of the sizing employed in the manufacture of such papers.

He says his experiments have demonstrated that if such waste newsprint papers are boiled in, or subjected under a correspondingly high temperature to the action of, a solution, containing approximately two pounds of borax in one thousand pounds of water, the oily and resinous ingredients of the printers' ink, and the cohesive ingredients of the sizing, are liquified and saponified sufficiently to enable the fibres of the pulp to be separated therefrom, and that even a more concentrated solution of borax may be used in this way, without producing the discoloring, or any other detrimental effect upon the fibres of the mechanical woodpulp contained in the waste papers thus treated. The waste papers may be thus treated before being pulped or after having been pulped; the most practical method is, however, to use the borax solution in the beating engine.

If the waste papers are to be treated with the borax solution after having been pulped in the beating engine, the quantity of water, contained in the pulped material must be taken in consideration in determining the quantity and the initial strength of the borax solution to be added thereto.

The most practical way of conducting the process of recovering pulp from waste newsprint and from other grades of paper, containing mechanical woodpulp, according to Burby's invention, is as follows:

A quantity of the borax solution, heated to near its boiling point, is filled into the tank of the beating engine, the beating

engine is started, and the waste papers, after having been dusted and roughly separated, are successively thrown in. A further supply of the borax solution and of the waste papers are successively added until the tank is filled to the full capacity of the beating engine. To secure the best results, about 15,000 lb. of the solution should be used for every 1,000 lb. of dry weight of the waste papers to be pulped in the beating engine and the initial strength of the solution should be somewhat in excess of the stated standard (two pounds of dry weight of borax to 1,000 lb. of water) because the borax, contained therein, is quite rapidly being consumed in saponifying the oily ingredients of the ink, which are first acted upon by the solution. The action upon the cohesive ingredients of the sizing takes place later, that is, when the waste papers have become thoroughly permeated by the solution. The initial consumption of borax amounts to about eleven per cent., and is greater, if less than 15,000 lbs. of the solution is used for each 1,000 lbs. of the dry weight of the waste paper stock.

By the time when the waste papers are thoroughly pulped, all cohesive ingredients of the printers' ink and of the sizing are dissolved or liquefied, and the insoluble impurities, like the pigments of the ink, clay or other filler and the like, are commingled with the pulp fibres. The pulped material is then discharged from the beating engine into a chest, the liquid drained off, as far as is practicable to be done without pressing, and the pulped material washed with fresh water. This washing can be done in the chest, if the chest is provided with some mechanical device for agitating the pulped material and disposes of the borax solution, and of the dissolved or liquefied ingredients of the ink and of the sizing, remaining in the pulped material after draining. It is preferable to employ a mechanical agitator in the chest to save the handling of the material. The washed material is then conveyed upon screens, or other suitable apparatus, where the insoluble impurities, like printers' ink, clay, filler, etc., are separated from the pulp fibres and the latter collected.

Instead of pulping the waste papers in the borax solution they may be subjected

to its action after having been pulped in the beating engine. In such a case the pulped material is conveyed from the beating engine into a chest, provided with a mechanical agitator, the solution, in quantity and strength to be determined upon consideration of the quantity of water contained in the pulped material, is added thereto, and the mechanical agitator set in action. The chest should be provided with means for heating the solution and the pulped material, and the heating and agitating of it should be continued for about one hour or less. Then the liquid is drained off, as much as it can be, the pulped material washed with fresh water and conveyed upon screens, where it is treated in the same way as explained above to separate the pulp fibres from the impurities.

If the waste papers are to be treated with the borax solution before pulping them, they must be first dusted, and roughly separated, before being charged into a boiler, or other suitable apparatus, filled with the borax solution. Approximately the same proportionate quantity of the borax solution should be employed. The boiler should be provided with means for heating the solution and it is desirable to provide also some means for agitating the papers while they are being acted upon by the heated solution. This treatment should be continued for not more than an hour and then the liquor is drained off, the waste papers discharged into a chest and after being washed in fresh water are conveyed into the beating engine. The pulped material is pumped upon screens and there treated with streams of water to separate the pulp fibres from the insoluble impurities, and the clean pulp collected. The pulp recovered by either way of conducting the process does not require any further treatment and may be conveyed to the papermarking machine, or stored for future use.

Another method is the subject of a patent issued to C. K. Hahle, of Reutlingen, Germany, and is said to avoid the drawbacks of the old processes. It consists in which an economical cleaning of the old paper is rendered possible. This effect can be attained only in case the method is

carried out exactly as explained and the following points of view are considered.

First of all the connection between color or ink and paper must be so much loosened, as to render possible a complete washing out of the impurities in the subsequent process. In order to cheapen as much as possible the whole process the diluted solution of alkali employed requires to be recovered after its use and to be repeatedly used over and over again in the following operations, so that always only the quantity of alkali lost or consumed in the previous process need be compensated for.

It is for this reason, that at the moment that the alkali is about to be recovered, the paper requires to have essentially maintained its structure, in other words it should at this moment not yet have been turned into a pulpy mass, since otherwise the recovery of the alkali would be practically impossible. The old paper so preliminarily treated then requires to undergo a most extensive mechanical disintegration, whereupon the washing of the finely divided material on sieves by means of sprinklers is effected.

A further essential feature of the new method consists in that during the disintegration subsequent to the treatment with alkali every objectionable pressing effect is avoided. The new method is as follows:

The old raw materials are first soaked with a diluted lye, until the connection between the paper and the color or ink is sufficiently loosened, then subjected to a light pressure for squeezing out the liquid. This is best effected by means of an endless sieve, which receives the material and conveys it between several consecutive pairs of lightly loaded squeezing rolls, whereby the excessive quantity of lye is squeezed out. The liquid flowing off is returned to a reservoir, in order to be afterward restored to its initial state.

The transmission of the material and the removal of the lye may, however, also be effected by means of a tapering conveyor or any similar device.

The material thus preliminarily treated is then put in a vessel and a convenient quantity of water is introduced whereupon the material is reduced to fibres by means

of twirls or agitators, so that the printers' ink and similar inks gradually separate from the fibres. Care should be taken to protect the mass from pressing effects. Agitating apparatus of any improved construction may be employed, which are capable of finely dividing the material by means of rotary agitators or twirls. The known apparatus called in German "Glockenzerfaserer" are particularly suitable for this purpose. In order to free the fibrous mass from the loosened impurities, it is now placed on an endless belt of fine wire-gauze and passed therewith beneath sprinklers, so that the sprays can carry off the impurities. At the delivery end of the sieve the completely cleaned fibrous mass can be taken off.

The process can be carried out continuously, even for the largest quantities, and requires but small quantities of chemicals and small outlays for wages and driving power, so that it can be employed most advantageously for all sorts of old papers, also for papers of the lowest quality.

---

#### BRITISH COLUMBIA PAPER DUTY FREE.

---

The United States Treasury Department has now delivered definite instructions to customs collectors to permit the entry free of duty of pulp and paper manufactured by the Powell River Paper Co., though made from wood grown on Crown lands. The Provincial Government, it will be remembered, recently removed the restriction on wood owned by that company. The following is the text of the U. S. decision:

Under the provisions of paragraphs 7 and 8 of T. D. 31772 of July 26, 1911, free entry is denied to wood pulp, paper and paper board manufactured from wood cut on the provincial lands of the Province of British Columbia lying west of the Cascade Range of mountains. This decision was made in view of the provisions of Section 49 of Chapter 30 of the laws of the Province of British Columbia, being "An Act to Amend and Consolidate the Laws Affecting Crown Lands," consolidated for convenience only, 21st of March, 1910, and cited as the "Land Act," that



portion of the section involved reading as follows:

"All timber cut under lease, special license, or general license, from provincial lands lying west of the Cascade Range of mountains, must be manufactured within the confines of the Province of British Columbia, otherwise the lease, special license or general license shall be cancelled."

The Department is now in receipt of a certified copy of an Order-in-Council of the Government of the Province of British Columbia dated July 12, 1912, which is reported by the Minister of Lands of that Province to be in full force and effect, providing that all pulp wood which has been or shall be cut on certain lands leased on January 9, 1907, or the paper, paper board or wood pulp manufactured from the wood cut on such lands, may be exported free of any export duty, export license fee or any other export charge of any kind whatsoever, or any prohibition or restriction in any wise relating to such exportation.

The lands covered by this order are described as follows:

Lease No. 2—Lots 148 to 155 inclusive, lots 160 to 160a inclusive, lots 162 to 167 inclusive—all in range 1, Coast District. Lots 104 to 122 inclusive, lots 124 to 151 inclusive, lots 153 to 154 inclusive—all in Range 2, Coast District.

Lease No. 5—Lot 493, Range 1, Coast District.

In view of these facts the said circular No. 48, T. D. 31772, as amended by T. D. 31890 and T. D. 32238, is hereby further amended as follows, such amendment to be effective from July 12, 1912:

(1)—By adding at the end of subsection (c) of paragraph 7 the words, "or west of the said range and within lease No. 2, lots 148 to 155 inclusive, 160 to 160a inclusive, 162 to 167 inclusive, all in Range 1, Coast District; lots 104 to 122 inclusive, 124 to 151 inclusive, 153 to 154 inclusive, all in Range 2, Coast District, and Lease No. 5, lot 493, Range 1, Coast District" so as to read as follows:

"(c)—Wood cut on the provincial lands of the Province of British Columbia lying

east of the Cascade Range of mountains, or west of the said range and within Lease No. 2, lots 148 to 155 inclusive, 160 to 160a inclusive, 162 to 167 inclusive, all in Range 1, Coast District; lots 104 to 123 inclusive, 124 to 151 inclusive, 153 to 154 inclusive, all in Range 2, Coast District, and Lease No. 5, lot 493, Range 1, Coast District.

(2)—By adding at the end of subsection (a) of paragraph 8 the words "except on lands covered by Lease No. 2 and 5, above described," so as to read as follows:

"(a)—Wood cut on the Crown lands of the Provinces of Ontario and Quebec, or on the provincial lands of the Province of British Columbia lying west of the Cascade Range of mountains, except on lands covered by Leases No. 2 and 5, above described."

Subject to compliance with the regulations in the said circular as thus amended, liquidated entries of such products imported on and after July 12, 1912, may be re-liquidated free of duty where the liquidation has not become final, and free entry will be granted to wood pulp, paper and paper board in bond for which no permit of delivery has been issued.

The Secretary of State has this day been advised of this amendment of the said regulations and requested to instruct the consular officers concerned to add to their usual certificate on invoice a specific verification of the exporter's declaration of origin.

English capitalists are reported to be forming plans for the acquisition of the Maniwaki Light & Telephone Co.'s plant and water power at Maniwaki, Que., on the Gatineau River, north of Ottawa, and building there a large pulp and paper plant.

\* \* \*

The Nepisiguit River Pulp Co., which contemplates building a pulp mill near Bathurst, N. B., are understood to have made satisfactory arrangements with the men interested in water rights on the Nepisiguit River, and plans will now be developed as rapidly as possible.



### NEWFOUNDLAND'S PROGRESS.

The forest resources of Newfoundland are a steadily increasing factor in its development. During 1911 there were fifteen lumber mills working under license, and 271 fishermen's mills without a license. The latter are permitted by the government to operate for the sole purpose of supplying the fishermen with material for the construction of their buildings, vessels, etc. The output of the mills for the season amounted to 53,187,000 feet, as against 45,000,000 feet for 1910. The pulp wood cut amounted to 100,000 cords, as against 30,000 cords during the previous year. The men employed in the woods numbered 3,715 and in the mills about 1,500. For the fiscal year 1911, 6,085,000 feet, valued at \$125,279, were exported, as against 7,707,000 feet, valued at \$144,666 for 1910. The export of laths amounted to 2,315,000 pieces, valued at \$4,768, as against 4,868,000, valued at \$9,646, for the previous year. The local building operations consumed the larger portion of the lumber and laths manufactured, and there is an increasing demand.

The pulp and paper mills at Grand Falls and Bishops Falls got fairly under way, and the two companies exported 21,064 tons of news paper during the fiscal year 1911, valued at \$943,699, and 27,177 tons of pressed ground wood pulp, valued at \$251,048. For the last six months of 1911 the export value of the products of the two mills amounted to \$1,136,199, and for the calendar year 1911 the estimated value of paper and pulp was placed at \$2,250,000. The importance of the paper and pulp industries may be seen by the fact that the company at Grand Falls at present employs about 2,000 men in its mills and 100 to 200 more in loading vessels. The total wages paid amount to about \$900,000 a year, and the mills, with the new machines installed, are expected to have an annual output of at least 35,000 tons of ground wood pulp and about 60,000 tons of paper. The company at Bishops Falls also employs a large number of men in similar work. At present it is at work on the extension of the pulp making plant, and further extension within a year is contemplated for the manufacture of various grades of paper.

### HELIN'S PATENTED BEATING MATERIAL.

H. Helin, a well known Swedish engineer, and until recently manager of the Skarblacka Paper Mill in Sweden, who, by the way, is now in Canada as announced in our news columns, has discovered a material to take the place of stone in beater rolls and bedplates. Stone, or still better basalt lava, has been found suitable for some qualities of paper, especially for imitation parchments and krafts, but it is costly and sometimes causes trouble, delay and additional expense, when it wears out and requires replacing.

With the assistance of Mr. C. F. Sodervall, he carried out many experiments at Brevens Bruk, and eventually obtained a porous composition of cast iron, which has been patented in their joint names and has shown itself to be quite as suitable as basalt lava for beating purposes, whilst the first cost is about one-half, and the length of life about double.

In making imitation parchments the power required and time of beating are about the same as when basalt lava is used. These beating organs, or beating members as they may be called, can be made in any size or form, and fluted in any way desired. In an ordinary beater roll they are secured in the usual manner, with wood wedges and wrought-iron rings shrunk on the ends. A roll and bedplate of Helin's material can be applied to any type of old hollander.

Engineer G. A. Staaf, of Orebro Paper Mill, gives the following results obtained by the use of Helin's material:—The material was applied to a hollander at the Orebro Paper Mill, and the results were compared with results obtained by beating with steel knives in an adjacent hollander of similar construction and size, both hollanders working on kraft paper.

Hollander With Steel Knives.—The roll was filled with 144 steel knives, 10 mm. thick, and 1,200 mm. long. The bedplate had 27 knives, 8 mm. thick and 1,200 mm. long. The time required for beating on a certain paper was four hours, and the power taken from start to finish was 70 horsepower.

Hollander With Helin's Material.—The roll was filled with 36 slabs of the ma-

terial. The bedplate was equal in area to the steel bedplate. The time required for beating on the same quality of paper as that made on the above hollander was two hours, and the power taken from start to finish 96 horsepower.

The hollander with Helin's material was put to work in March, 1911, and since then two other hollanders at the same mill have been equipped, whilst others are on order.

It is generally found, as in the above instance, that the beating of the stuff takes place in half the time, as compared with beating by steel knives. The consumption of power taken in the beating shows a saving of 45 per cent. to 46 per cent. in favor of the Helin material, taking into account the shorter time required for beating.

At the present time the material has been used in the beating of "news," "kraft," and M.G. papers from wood pulp. It can be made and applied to "Jordan" and "Marshall" refining engines, and the like.

The material is already at work in many Swedish and Norwegian mills, and, although only a short time has elapsed since its introduction, about forty outfits are at work or on order. It is evident that the invention of Engineer Helin will prove to be of great utility to the paper-making industry.

#### THE SIZING OF PAPER.

The Papier-Fabrikant points out that Kollmann has proposed to determine the sizing of paper by treating one side of the paper with an alcoholic solution of phenolphthalein, and the other side with sodium hydrate. The solutions penetrate the paper, and on meeting one another produce a red coloring thereof. The time between the application of the solutions and the appearance of the coloring is measured in seconds and is stated to be a measure of the sizing strength of the paper.

Comparative tests were made on about 200 papers—(a) by the usual method with pen, ruling pen and ink; (b) by the Kollmann method. These tests were made under exactly the same conditions throughout.

The papers considered improperly sized were those in which (a) the ink spread, whether it then penetrated the paper or not, and (b) the strokes of ink penetrated either when  $\frac{3}{4}$  mm. wide or when thin strokes.

The results of the tests by the Kollmann method do not even approximate to those by the inking method. While by the latter method only 7 per cent. of the papers under test were found to be insufficiently sized, by the Kollmann method 44 per cent. would have been considered defective for this reason. There were even numerous papers which indicated, with ink strokes 1 to 2 mm. wide, that they were remarkably well sized, whereas by the Kollmann method the sizing would appear to be weak; for tests of the sizing of paper the latter process is therefore not held to be suitable.

#### TRADE ENQUIRIES.

The following enquiries affording trade opportunities for Canadian pulp and paper houses have been received by the Department of Trade and Commerce at Ottawa. Further information can be obtained on application to the office of the Pulp and Paper Magazine, or at the Enquiries Branch, Department of Trade and Commerce, Ottawa. Reference should be made to the number in each case:

930. Paper bags.—A Cienfuegos firm is open to receive samples and quotations on paper bags.

944. Printing paper.—Canadian manufacturers of printing paper are invited to correspond with firm at Santa Clara, Cuba.

946. Stationery.—A firm in Santa Clara wishes to correspond with Canadian manufacturers of stationery.

1007. Paper bags.—One of the largest importers of paper bags in Cuba would like to hear from Canadian manufacturers of brown paper bags made of ordinary wood pulp. Local consumption is about fourteen millions per month. Bank references offered.

A striking exhibit at the Toronto Fair is by the Spanish River Pulp & Paper Mills, comprising some huge rolls of high-grade newsprint paper, the largest ever shipped from a paper mill.

## New Incorporations

John Martin Paper Co., Limited, Edmonton; capital \$100,000.

\* \* \*

Jeffrey Mfg. Co., Columbus, Ohio, capital \$6,000,000. Authorized to do business in British Columbia. David Gordon Marshall, Vancouver.

\* \* \*

Cottonwood Lumber Co., Limited, Vancouver; capital \$250,000. To acquire lumber limits, build booms, etc., for reception of lumber, pulpwood, and products thereof.

\* \* \*

Franco-Belgian Investment Company, Montreal. Capital \$100,000. To deal in lumber and all forest products. H. Robert, A. P. Mathieu, and C. O. Lacroix, Montreal.

\* \* \*

The Canadian Fairbanks-Morse Co., Toronto, makers of pulp and other machinery, is authorized to increase its capital to \$3,100,000. It will extend its factory considerably.

\* \* \*

The John McDougall Caledonian Iron Works Company, Limited, incorporated under Dominion laws, is licensed to do business in Ontario, using a capital not larger than \$25,000. R. H. Zavitz, Toronto.

\* \* \*

The Dorwin Falls Improvement Co., Limited, Montreal; capital \$250,000. To manufacture and deal in logs, wood pulp, and paper, and all articles of which pulp and paper, and all articles into which pulp and paper enters into as a component part alcohol, sulphite and other acids. G. W. MacDougall, K.C., Laurence Macfarlane, and Gregor Barclay, advocates, all of Montreal.

\* \* \*

Toronto Manufacturing Co., Toronto; capital \$1,000,000. To carry on the business of pulp and paper manufacturers, importers and dealers, and to manufacture and deal in pulpwood, chemical and mechanical wood pulp, and printing, writing, and all other kinds of paper and other articles incident to the manufacture of pulp and paper and articles in the making

of which wood pulp or paper forms a consistent part. The names mentioned in the official gazette are Alfred Bicknell, G. B. Strathy, and H. E. McKittrick, solicitors, and some accountants and law clerks.

### GREEN BAY BARKER CO.

Stimulated by the success which met the Green Bay Barker Co., Green Bay, Wis., with the Roberts & Libert Green Bay Barker as a machine for small wood, they are now introducing one to handle larger size wood. This machine will take wood from 4 in. to 22 in. in diameter, and 2, 4, or 6 ft. in length. It is strongly and heavily built, many parts being built of crucible steel and malleable iron, enabling it to withstand any strain. Its speed is 1,100 revolutions per minute.

The mechanical construction of the cutting head and roller section are in many respects similar to the small machine. The live rolls can be instantly reversed, and the wood run backward by the shifting of a foot lever, which of course is a great advantage when handling the large wood. The bumper roll is very easily operated. The crucible steel disc is 40 inches in diameter, and contains six knives. The amount of knife exposure is under control of the operator at all times.

This power of barking wood in 4 ft. lengths will render it valuable, especially at the present time to sulphite mills, as the wood can be run direct from the barkers to the chippers without resawing, and a great deal of end waste is eliminated. Several of the machines have already been installed and they bid fair to fill a real want.

Work on the new paper mill of the Ontario and Minnesota Power Co., at Fort Frances, Ont., is being rushed ahead, 125 men being employed on the foundations, and the main building is expected to be enclosed before winter sets in. The mill is 96 ft. wide and 500 ft. in length, but President Backus is understood to be considering an enlargement of the mill so as to increase its initial capacity to 150 tons per day.

## Testing Half Stuff

In connection with the work of the Royal Prussian Testing Institute, Professor Dalen communicates, in the journal of that institute, some extremely interesting details of experiments performed on the beating of half-stuffs and the preparation of sheets on the hand mould, for the purpose of comparing their strength.

In making sheets out of half-stuffs it is often impossible to obtain a good coherent sheet by dipping the mould into the vat in the ordinary way. If, however, the mould be immersed in the stuff in a horizontal position and the stuff be allowed to flow in upon it from all sides at once, and if the mould be then shaken before completely lifting it out of the liquid, very free and dilute half-stuffs may be converted into well felted sheets suitable for testing purposes. The method of dipping the mould and the direction in which it is shaken have little or no effect on the average strength of the paper, but not shaking at all reduces the strength very considerably because the fibres are not properly felted. Although the direction in which the mould is shaken has no influence on the average strength, it has a very considerable influence on the distribution of the strength, and it is possible to vary the ratio of the strength of the paper in the two directions of the sheet within very wide limits. What is generally the weaker direction of the sheet may be made the stronger by shaking the mould in the direction at right angles to the usual direction of shaking. Hence it is suggested that if a paper machine wire could be shaken in the direction of its length it would be possible to make machine made papers with nearly equal strength in the two directions.

After comparing sheets made from different samples of half-stuff in the practically unbeaten condition, Professor Dalen proceeded to ascertain whether it was possible so to control the work of his small experimental beater that comparative conclusions could be drawn as to the relative behaviour of his samples toward beating. It was found that satisfactory results could be obtained if care were taken

to maintain a constant setting of the roll and a constant consumption of power as indicated on the ammeter over measured times. Sheets made in different experiments from the same half-stuff beaten in the same manner gave sufficiently concordant results on testing. Naturally only half-stuffs of similar composition may legitimately be compared with each other, and in order to bring out the differences between the two samples of similar material, it is best to make sheets at definite intervals extending over a long period of beating. The result of prolonged beating is to increase tensile strength, stretch and resistance to folding up to a certain point: after the maximum is reached, the strength of the paper only suffers by longer beating, owing to the fibres becoming destroyed or "dead." The behavior of a half-stuff on beating affords a very valuable idea of its chemical condition. Materials which have suffered profoundly from severe chemical treatment develop their maximum strength quickly and then fall off on longer beating, especially as regards their resistance to folding. Materials which have been normally boiled and bleached show a steady rise in their strength qualities as the beating is continued until they finally become "dead" beaten. In the case of normally bleached fibres the resistance to folding can be developed to a higher degree than with strongly bleached fibres, and this folding resistance increases as beating proceeds. In the case of wood pulps, it was found that better strength qualities were obtainable from moist pulp than from the same pulp after drying, especially in the case of highly bleached samples.

A series of trials in the paper mill showed that sheets could be made on the hand mould which were quite comparable as regards their average qualities with those made on the machine from the same beaten stuff, but the experimental beater tended to give wetter stuff and stronger papers than the mill beaters.

---

The Meyer-Thomas Box Mfg. Co.'s plant at Granby, Que., was destroyed by fire at a loss of \$150,000.



## Presence of Acid in Paper

The question of acid in paper is a very important one, and it is also one on which most papermakers are very slack. In the usual run of papers it makes but little difference whether they are neutral or not, but in quite a few the quality could be much improved if this matter was properly looked after. The tests to which papers are subjected in order to ascertain the amount of acid they contain are many, and some of these are not at all reliable. For instance, take a piece of paper, and placing a drop of weak neutral litmus upon it, it will turn the same red, but it cannot be said that the paper is acid because of this fact, for it is found by immersing the same paper in a carefully prepared and neutralised solution of Congo red the color will be the same as if an alkali was added to it; then it would seem that paper was alkaline. The same experiment may be tried with methyl orange, and this also indicates that the paper is alkaline. Thus it is a question as to whether the paper will be called acid or alkaline. Acid or alkalinity is a matter of degree the same as heat or cold; when one acid is stronger than another it is capable of replacing it; the same applies to alkali. In paper there are substances always present which consist of a mixture of an acid and a base. The same substance may play the part of an acid or base, according as the substance with which it is in combination is more acid or basic than itself. Alumina is dissolved by soda to form sodium alluminate, when it acts the part of an acid substance. If sulphuric acid is added to this, which is a much more powerful acid substance than alumina, the alumina is discharged by the sulphuric acid, and if further acid is added it turns over and becomes the base and enters into combination with the acid to form sulphate alumina. There is a substance known as normal alumina sulphate. When these two substances are compared the former is strongly alkaline to the latter, or the latter acid is compared with the former. The former substance is neutral to litmus, and the latter to Congo red. It is stated on good authority that a neutral point with methyl orange is reached

when there is present two molecules of alumina to five of sulphuric acid. With Congo red the ratio is two of alumina to six of sulphuric acid. By using these three tests a very good idea of the condition of the paper, as far as acid and alkali are concerned, can be obtained. When the paper is alkaline to Congo red it shows that there is no acid present; the fact that the paper is acid to litmus points to the probability of the paper containing a low sulphate of alumina, although if the whole of the alum were free, or even some of it in combination with the soda, the paper might still give an acid reaction with litmus. When Congo red is added to a solution of alum or sulphate of alumina it does not give the acid reaction unless there be free acid present. The same holds good with paper, and if a drop of Congo red is placed upon it the paper turns blue, and contains free acid. If it is alkaline to methyl orange, but acid to litmus, it probably contains a basic sulphate of alumina. If it is basic to litmus, but is found to contain both sulphate and alumina, there is no basic sulphate of alumina present. The best way to make an acid or alkaline test on papers is as follows: Prepare the three chemicals, namely, litmus, Congo red and methyl orange, in neutral and very dilute solutions, each recently boiled and cooled in distilled water. Take a stirring rod and dip it into the solutions, and allow a drop of it to fall upon the paper, then note how long it takes to produce the acid or alkali reactions.

### EXPANSION OF PAPER IN SUPERCALENDERING.

Is it possible to make paper supercalendered and not have it expand? To make a paper that will not expand on being supercalendered is an impossibility, for the pressure of the calender rolls cause expansion of paper as it passes between them. This expansion of paper may be lessened by quick beating of the stock, making it as free as possible on the wire. It is a well-known fact in papermaking that paper made from free or quickly beat-



en stock will not expand or stretch as will paper made from slow or wet beaten stock. Another means of keeping the expansion as small as possible is by carrying in the paper all the loading material possible, as a high calender finish can be obtained without heavy pressure being applied to rolls. Paper made from various sulphite woods will expand less than that made from rags. When making a paper for supercalendering, and wishing to have it show the least possible expansion, the draws between different sections on machine should be pulled as slack as possible, for when they are drawing tight the two edges of the sheet are pulled toward each other, so that they contract more than is necessary, and paper made in this manner will expand more than supercalendered.

#### PAPER MACHINE WIRES.

The duration of a paper machine wire is a question which frequently comes up. The wear takes place during the making of the paper and its life therefore should depend mainly on the quantity of paper made. The wear is caused by the action of the suction drawing the water through the paper and the wire against the face of the suction box. The chemicals used in the paper are also very damaging to the wire. Consequently when one figures the amount of paper made on the wire he must also consider the composition of that paper, as well as the weight of it, and the speed at which the machine was run while it was being made. Wires upon which heavy papers are made will not run as long as wires making average weight paper continuously, so the quality and kind of paper have to be taken into consideration. Another thing which has its influence is the water which is used in process of manufacture. Some times it is so bad that the wire has to be cleaned frequently with sulphuric acid. The only way in which the quality of a wire can be correctly gauged is to take note of the conditions under which the wire was run; the quality of paper made and the amount of chemical used in the furnish, the condition of the water and the weight of the paper made, as well as the basis of weight. The width of the deckle is another factor

connected with the life of the wire, and the narrower the deckle runs the shorter will be the run of the wire, for a greater strain is placed upon it by the suction. The condition of the couch jacket is another consideration, and when an old jacket is run on a new wire the wire is worn out more quickly.

What causes the wires to give out quickly on the edges is due to three things:

Defective wire guides.

Uneven weaving of the wire.

Carelessness of the machine tender.

A defective wire guide will cause the wire to crack and become slack on the edges. Sometimes when a heavy vacuum is being carried on the suction boxes it has a tendency to cause the wire to run strongly against the guide pans, having the same effect upon the edges of the wire as a defective wire guide would have.

As to the defect in the weaving of the wire the edges of these wires are sometimes tighter than the middle, consequently the tension and strain is held by the edges until they crack and become ragged.

Through the carelessness of the machine tender the stock is allowed to accumulate on the end of the stretch roll and carrying rolls of the wire, causing it to stretch and become baggy, and making it useless to run paper on. When starting the machine the stuff sometimes overflows the slices and deckle straps, jams the wire and passes through the couch roll in lumps.

#### COLORING PULP.

Though impurities of water used in making pulp may not necessarily have any effect on it when it is subsequently dyed, yet in some cases it does so, and in any event the purer the water the better.

The impurities in all waters, whether from wells or rivers, consist both of mineral and vegetable matter and the proportion between the two, and also the absolute amount of either depends solely upon local conditions. It may be remarked, in passing, that plant fibres floating in the water, although they may settle on a paper web in default of efficient catchers, have no effect worth noticing on either mordants or dyes.

Such impurities as iron, lime and magnesia are usually present in well water or water from springs. They have a very prejudicial action on paper-pulp dyeing, both on the mordants and on the dye itself, whereby the resulting dyeings are dull, and of a different shade from what was intended. The action of hard water on alumina and iron mordants is very pronounced, and the same may be said, to a less extent, however, in respect of tannin mordants. The following dyes, largely used for paper and paper-pulp dyeing, are particularly susceptible to the action of hard water: Brilliant green, malachite green, fuchsine, methyl violet, and Bismarck brown. We may add all the dye-wood colors, with the remarkable exception of logwood.

It follows then, that hard water must be corrected with acetic acid.

As regards half-stuff, water containing carbonate of iron seems to exert a particularly baneful influence, as also does water from peat bogs. Water of this kind is apt to throw down hydrated peroxide of iron at unseasonable times, thereby interfering with dyeings, especially those of light shades.

The worst water-difficulty, however, for a paper mill is when it happens to occupy the position of the lamb in the fable, the wolf being textile works higher up the river from which the mill draws its water. These textile works make the water vary so much in quality that unless the river is very large it can be relied on in flood-time only.

In many cases it is advisable to have a separate supply of water for pulp which has to be dyed, as great purity of water is not quite so urgent in making undyed paper.

To sum up, it is a question of local conditions. If the water available is equally good for pulp which has to be dyed and for pulp which has not to be dyed, so much the better. Should this not be the case, the preparation of the pulp to be dyed should be in the hands of a person skilled in paper dyeing; one that is competent to adopt the necessary precautions.

## WOOD-PULP YARN.

The Society of Dyers and Colorists usually confines its attention and discussion to matters affecting the textile and allied industries, but at a recent meeting in London a paper was read on the subject of "Wood-Pulp Yarn: its Manufacture and Uses," by Mr. Dreaper. In the course of discussing the properties of the yarn it was mentioned that the yarns lose their tensile quality entirely on wetting, and that they only have the strength of jute fabrics of the same make and weight. After soaking in cold water, the "Kron" yarn seems to lose 75 per cent. of its strength, but still has a breaking strain of 170 grms. The yarns have an elasticity of 6 to 7 per cent. and a breaking strength of 5 to 7 kilos. It is difficult, however, to estimate without trial what would be the behavior of such yarns under practical wearing conditions, especially when they are woven with other fibres, and although the former statement may be true in itself, yet in the actual use of such yarns in practice more satisfactory results have been obtained than might be expected. For instance, a sample of table cloth material which has been in use in Germany for three years, with constant washing, is still quite good. It contains some 60 per cent. of this yarn.

It is only by actual trial that the working properties of such materials can be tested, and these seem to be satisfactory, within certain limits, which may be regarded as giving the yarns a place in the textile industry. The yarns are manufactured in Germany—in one factory to an amount of 6 to 7 tons per week. Factories are being erected that will devote themselves particularly to its use in the manufacture of sacks and such like materials. At the same time these yarns have an actual decorative value, many really beautiful products being now obtainable.

Dyeing seems to present no real difficulties, and may even be conducted in the yarn state. These products will have special interest to the dyer and to the cleaner, who may once more have their working conditions rendered more difficult. The

many uses that this yarn has been put to include the manufacture of wall and paper coverings, hessians, tarpaulins, braids, hatbands, tweeds, suitings, and overalls, and many other cloths of varying makes, in addition to the use of the yarns themselves in the shape of twine and string. The value of the paper-pulp in yarn form has been well expressed by O. N. Witt in terms of the comparative value of one c.m. of wood, which has been put at 75 cents. Transferred into paper it has a value of \$8.75; into paper yarn, \$11.25; and into artificial silk, \$37.50. These figures are significant.

**HINTS FOR THE FINISHING OF PAPER.**

If the finishing of the paper is to keep pace with the present increased productive capacity of paper-machines, there must be provided spacious workrooms, efficient auxiliary machinery, modern means of transport and a trained staff. The rooms should be so dimensioned that at least a four weeks' production can be accommodated in them without using the stores. When building a new mill the architect, engineer and paper maker must co-operate so that for the finishing of the paper suitably located and well-lighted workrooms are provided, and each machine is put into its correct position.

In large mills the finishing of paper is divided into the following five sections:

1. Rolls. 2 Sheets. 3 Sorting and counting. 4 Pasting, packing, and despatching. 5 Stores.

In all cases it is desirable to arrange on the ground floor of the glazing room the auxiliary machines for the rolls, as well as the sizing machines, and besides these the cross cutter, sheet-calenders and hydraulic presses for the sheets. On the other hand the four-side trimmer and the ruling, folding and ream-cutting machines belong to the immediate neighborhood of the sorting department.

Paper which is to be despatched in rolls should be rewound, packed, and shipped,

as near as possible to the machine room. For the better papers the erection of auxiliary machines in the sorting room itself is to be avoided, and a floor free from dust should be selected. Sorted and counted piles of paper should be wrapped in packing paper in order to prevent the edges becoming dirty or yellow. By suitable transport appliances it may be arranged that the paper is handled as little as possible.

Supercalendering can be carried out with more speed and certainty if the paper at the end of the paper machine is passed over two cooling cylinders. Moreover it is well to use tightly wound rolls with smooth ends and consequently to employ round shells of at least 20 c.m. diameter. The earlier method of storing the rolls to be supercalendered for a long time in the cooling room has fallen into disuse, because moistening machines are available whereby any desired degree of moisture uniformly distributed can be imparted to the paper. Sheet supercalenders are required only for better paper over 80 g. per sq. m. which are to be glazed in a direction opposite to that of the machine.

The first rolls of each production should be carefully kept separate and distinctly marked in order to prevent them being mixed with the remainder.

Records should be kept relating to the output of the various machines whereby accurate information may be obtained for the calculation of prime cost.

In order to awaken in the employees an interest in, and desire for their work, they should be given an opportunity of working at the various machines.—Der Papier-Fabrikant.

The Laurentide Paper Company's profits for the year ended June 30, 1912, after providing for interest and other charges, including an amount of \$103,879 for betterments to the plant, were \$753,572.

Mill nets from ground wood, sulphite, pulp, paper and card board. . . . .	\$910,846
Profits from lumber and miscellaneous . . . . .	98,706

The old board was re-elected and Sir William Van Horne was re-elected President, and George Cahoon Vice-President.

## Pulp and Paper News

P. Byrne, superintendent of the Riordon Pulp & Paper Co., at Merriton, Ont., has gone on a holiday to Ireland, his old home.

\* \* \*

The Laurentide Paper Co. are erecting a new power house at Grand Mere, Que. They are also thinking of putting in a new digester.

\* \* \*

Donnacona Paper Co., Ltd., Toronto; capital, \$3,500,000. Authorized to do business in Ontario. J. S. Lovell and Robert Lovell, Toronto.

\* \* \*

The St. Lawrence Paper Mills, Mille Roches, Ont., are putting in a centrifugal pump made by the Smart-Turner Machine Co., Ltd., Hamilton.

\* \* \*

Geo. Bean, a young employee of the Canada Paper Co., at Windsor Mills, Que., was knocked down by a freight train and killed instantly.

\* \* \*

Carl Riordon, of the Riordon Pulp & Paper Co., of Montreal, has returned from an enjoyable holiday and fishing trip in the Laurentian Mountains.

\* \* \*

David F. Robertson, manager of the Northumberland Paper & Electric Co., of Campbellford, Ont., will shortly be married to Miss Christine Barker, of Picton, Ont.

\* \* \*

Canadian exports of news paper to Australia during 1911 showed a perceptible decrease due either to accumulation of stocks or to competition from Scandinavia.

\* \* \*

L. Grey, formerly connected with the Sturgeon Falls mills, is reported to have a project for building a sulphite plant at Thorold, Ont., with a capacity of 70 tons daily.

\* \* \*

The Pulp and Paper Magazine last week enjoyed a visit at its Toronto offices by Mr. Thomas Denholm, of Glasgow, a

widely known paper manufacturer's agent and exporter.

\* \* \*

H. Helin, engineer, and formerly manager of the Skarblacka Paper Mill, Sweden, recently arrived in Canada to manage the new mills of the Wayagamack Pulp & Paper Co., Ltd., at Three Rivers, Que.

\* \* \*

Good progress is being made on the building for the Interlake Tissue Mills at Merriton, Ont., the roof being nearly completed, and several turbine wheels having been already put in position. J. J. Herb has been appointed superintendent of the new mill. He was for many years with the Wisconsin Tissue Mills, Appleton, Wis., and is looked upon as a thoroughly capable, experienced paper maker.

\* \* \*

The Wood Chemical Co. has been granted by Belleville, Ont., a free site and a fixed assessment for a term of years. The company, which owns considerable tracts of timber lands in Ontario, will put up a plant to cost \$150,000. J. H. Larmouth is manager.

\* \* \*

Machinery is now being installed in the Dryden Timber and Power Co.'s plant at Dryden, Ont. Four large Jenckes Machine Co. diffusers, two 20-ton incinerators and eight boilers have already been placed in position. The dam is almost completed.

\* \* \*

Joseph Kilgour, of Kilgour Bros., Toronto, and the Canada Paper Co., was last month married to Mrs. T. G. Bright, of Toronto. Mr. Kilgour has a very wide circle of acquaintances in the paper trade and they are all congratulating him.

\* \* \*

The Grenville Board & Pulp Co. have a striking exhibit of their fibre board at the Toronto Fair. It comprises a two-roomed house, the outer walls of which are covered with a layer of their board only one inch thick, but sufficient to resist both heat and cold. This also forms the inside finish.



## Montreal Pulp and Paper Matters

(Special Correspondence Pulp & Paper Magazine.)

Montreal, Aug. 30, 1912.

The pulp and paper industry in so far as the Province of Quebec is concerned was never in a more prosperous condition than at the present time. Every paper mill is running to full capacity and orders are pouring in for all grades of paper and for sulphite. The only exception to the pronounced activity is ground wood pulp. This is somewhat better than it was, but is not as brisk as usual owing to the plentiful supply of water in the United States. It is expected, however, that it will show an improvement from the fact that water in the United States is becoming low. In addition the demand for ground wood will be exceptionally heavy this fall owing to the presidential elections. Those in a position to know state that ground wood will show a marked improvement within the next month or two despite the fact that the output of that product in Canada today is 400 tons more than it was a year ago. Prices of ground wood remain firm, but an advance is expected.

### The Market.

News prices are higher and the demand is splendid. The prices of all lines of paper in the United States have advanced on account of the increased cost of sulphite, which is \$6 to \$7 a ton higher than it was this time last year. Sulphite has shown a continuous advance for several months, and is likely to go much higher. This commodity delivered in the United States costs from \$45 to \$47 per ton. The only exception to the general advance in the price of paper is in connection with manilla and wrapping. This is accounted for by the fact that kraft paper has fallen to 3½¢ on account of the kraft market throughout the world being dull and local mills in the United States turning to the manufacture of kraft paper. However, the outstanding feature of the market is the extraordinary situation in sulphite which continues to attain new high figures.

Preparations are being made by the Riordon Paper Company to expend \$500,

000 on their mill at Hawkesbury, Ont. This will increase the output of their sulphite mill by from 30 to 40 tons. The work will be commenced inside the next month or two, and will be completed early in the new year.

### New Legislation for Quebec?

Quebec paper manufacturers are asking if there is any likelihood of Sir Lomer Gouin putting through an order-in-council similar to that passed by the British Columbia Government in connection with the Powell River Pulp & Paper Co., of Powell River, B.C. In connection with this company's limits the British Columbia Government removed the embargo, thus permitting the output of the mill to enter the United States free of duty. This of course was an immense gain to the Powell River Company and local paper manufacturers are wondering if Sir Lomer Gouin's visit to British Columbia will be taken advantage of by him to look into the working of the special provisions granted the Powell River Company. Sir Lomer, who is a progressive and at the same time a shrewd politician, is about to visit the western part of Canada.

### Pulp and Paper Mill for Abitibi.

Montreal interests, among whom are Messrs. Shirley Ogilvie and F. H. Anson, both connected with the Ogilvie Flour Mills, Ltd., have entered the Ontario pulp and paper field. During the past year or two the pulp and paper industry of the Province of Quebec has been forging ahead at a remarkably rapid rate. New companies by the half score have been incorporated and old companies have found it necessary to increase their capitalization, while existing mills have been enlarged and improved. From the stock market end there has been a marked advance in the shares of the various companies and a number of them have been very largely traded in. The result of the activity has been to create a great deal of wealth for those who were far-sighted enough and fortunate enough to invest their money in these industries. During the past year Montreal capitalists have been branching



out and investing in Ontario and British Columbia pulp and timber limits. In a measure the financing of the Spanish River and Ontario Pulp and Paper Companies was undertaken by Montreal interests as well as their final merger. Montreal capitalists have also been active in British Columbia lumber propositions. Now comes the latest move on the part of Messrs. Ogilvie and Anson in connection with the Abitibi limits. These two men were the successful tenderers for the limits put up by the Ontario Government. They will pay \$5,000 a year for twenty-one years and in addition will pay certain water rentals and other dues levied by the Government as well as 40 cents a cord for spruce pulp wood and 20 cents for other kinds of wood. These two successful tenderers expect to interest local capital and will form a million and a half dollar company. They will then build a half million dollar pulp mill with a daily output of 100 tons, to be followed later on by a 75-ton paper mill. They will also spend in the neighborhood of \$50,000 in erecting workmen's houses at their mills.

During the past week C. Meredith & Co., Ltd., of Montreal have been advertising \$500,000 of 6 per cent. first mortgage bonds of the Rolland Paper Company, Limited. This company was established in 1883 by the late Hon. J. B. Rolland, and is now carried on by his two sons, the Hon. J. D. and Mr. S. J. B. The company recently absorbed the Northern Mills Company at St. Adele. They propose using \$200,000 of the new capital for the purpose of enlarging their mill at St. Adele and installing the most up-to-date machinery in all their mills. The company will specialize on the manufacture of high-grade ledger and bond papers. The Hon. J. D. Rolland, the present head of the company, was a former president of the Canadian Manufacturers Association, and is now president of the Banque de Hochelaga and a director of a large number of financial and commercial enterprises. He is also a member of the Legislative Council of the Province of Quebec.

#### Government Interest in Quebec.

The Hon. F. D. Monk has recently been on a tour of inspection through the Pro-

vince of Quebec for the purpose of investigating the necessity for public works. He visited several of the large pulp and paper mills on the Lower St. Lawrence and on the Saguenay to see if they needed better docking facilities or any other public works which would facilitate the handling of their output. He has not announced what he will do, but it is probable that there will be a generous expenditure of Government money on the Lower St. Lawrence. In the course of his tour he visited the mills of the Chicoutimi Pulp Company and found that their output was 550 tons of mechanical pulp per day with a branch at Lake St. John, turning out 200 tons per day. The company propose to construct an additional mill with a capacity of 500 tons per day.

The Hon. Jules Allard, Minister of Lands and Forests, in the Province of Quebec, and Mr. G. C. Piche, Chief Forester of the Province, are among those from this Province who will take part in the annual meeting of the Canadian Forestry Association at Victoria, September 5th and 6th. There is a growing interest among pulp, paper and lumbermen in this province in the work of the association, which was largely stimulated through the meeting held in Quebec two years ago. A number of other prominent lumbermen and paper men from this Province will attend the convention.

#### New Labrador Enterprise.

The announcement has just been made that one of the largest pulp and paper enterprises ever entered upon in this country has been decided upon by the Labrador Pulp and Power Company. This involves the increase of the capital of the company from \$3,000,000 to \$15,000,000, and is being put through by Mr. Robert H. Reid, of New York, and other American interests.

Mr Reid stated that the undertaking would mean the development of one of the most important water powers in Canada, namely the falls on the Hamilton River, which are regarded as being second in power to those of Niagara. It is the intention of the company to build two large mills, one at Hamilton Inlet and the other at Sandwich Bay, the combined output of which will be 150,000 tons of paper yearly.

The money for the purpose of erecting the mills as well as for the increasing of the capitalization will be raised by private subscription.

Price Bros. & Co., one of the largest lumber and pulp concerns in the Province, are making active preparations for still further enlarging their business. The company is developing 7,500 h.p. on the Ship-saw River some two and a half miles distant from the new mills. This will enable them to instal more machinery and permit of enlargements to their mills. The company have at the present time 18,000 h.p. at Jonquiere on the Saguenay River.

---

### NEWFOUNDLAND PULP AND PAPER NOTES.

(Special to Pulp & Paper Magazine.)

August 31, 1912.

The Horwood Lumber Company are erecting a pulp mill at Campbellton, a milling settlement in the District of Twillingate. The erection of the mill will cost about \$250,000. For a number of years the Horwood people have been carrying on an extensive lumbering business at Campbellton, and their new venture is an off-shoot of their old and well-established business. They have a large tract of land thickly wooded with spruce and fir, very suitable for the manufacture of pulp.

The Exploits River has been in splendid condition the past season for driving purposes, and the pulp and paper mills, both at Bishop Falls and at Grand Falls, are now working at full capacity. The two new paper-making machines have been installed at Grand Falls, and that plant is now able to turn out 190 tons daily.

Messrs. H. Ramsen and G. Hardy, who planned the Harmsworth and the Albert Reed mills, are now planning another big mill at Glenwood, on the Gander River, for a party of Americans, of which J. Loizeau, of New Jersey, is head. Last fall they spent several weeks on the river making the necessary surveys for water power and transport facilities and were so pleased with their observations that they have since been busily engaged preparing plans, etc.

The Gander River has for many years been the scene of great lumbering activities, and millions of feet of white pine have been shipped yearly to foreign markets, besides what has gone to the local trade.

A big pulp and paper mill project is now spoken of for the head of La Poile Bay, on the South Coast. This will have the advantage of an ice-free port, open all the year round. There are great regions of pulp timber in that part of the country.

Forest fires which have wrought such havoc among the timber lands of all North America, held considerable sway in various parts of Newfoundland the past summer. Though fire wardens were stationed along the main trunk of railway, they found it impossible in many instances to cope with the fires. It is estimated that over twenty million dollars worth of pulp timber has been destroyed in this country by forest fires.

The question of reforestation is receiving considerable consideration at present. Some experimentation has already taken place. It is in some quarters recommended that legislation should be enacted compelling the planting of a tree for everyone felled by parties holding Crown lands timber limit licenses. It is generally conceded that some such method will have to be adopted if the country desires to retain the valuable asset it has in its extensive timber lands.

---

The Dominion Bond Co., which controls the Spanish River and Sturgeon Falls Pulp & Paper Mills, will increase its capital from \$500,000 to \$1,000,000. This company is comparatively new in the financial world, but its enterprises have so far been attended by conspicuous success.

\* \* \*

Prof. T. L. Crossley, of Montreal, who is a well-known specialist in the technology of pulp and paper manufacturing, and who has been a valued contributor to the columns of the Pulp & Paper Magazine, has been appointed English Professor of Chemistry at the Montreal College of Pharmacy in succession to Prof. B. Collitt.

## Pulp and Paper Markets

### CANADIAN PULP AND PAPER MARKETS.

Toronto, Aug. 30th, 1912.

The situation in the paper trade continues satisfactory in practically all lines, although there is really very little development of a new character on which to comment. The feeling in newsprint is that it is likely to keep firm for a long time to come. The book and writing mills are well employed. Wrappings retain their increased firmness, although there cannot be said to be any increase in price beyond that previously referred to.

The demand for ground wood is good, although nothing beyond normal, as owing to heavy rains across the border, the water powers there have improved. Some mills believe prices will improve and are indisposed to sell in large quantities for future delivery. Sulphite is still very strong.

### SCANDINAVIAN MARKETS.

At present the wood pulp market is very quiet, especially as regards mechanical pulp; but nevertheless the makers are hopeful and will not accept any modification in price in the matter of offers. As to sulphite, the market is exceedingly favorable, and the prices continue to show a rising tendency.

### BRITISH MARKETS.

London, Aug. 23, 1912.

There is a firm market for mechanical woodpulp, although not much actual business is passing. For chemical pulp the demand is good.

There is a very strong market for rags and nearly all kinds of paper stock, and prices have an upward tendency. The demand for chemicals is good and prices are quite strong.

### PULP AND PAPER STOCK PRICES.

Montreal, August 30th, 1912.

Quotations for pulp and paper stock are as follows:

News print, rolled, \$2.00.

News print, sheets, \$2.25.

Book papers—Carload lots No. 3,  $4\frac{1}{2}$  to  $4\frac{3}{4}$  cents.

Book papers—Broken lots No. 3,  $4\frac{1}{2}$  to  $4\frac{3}{4}$  cents.

Carload lots No. 2,  $4\frac{3}{4}$  c.

Manila B,  $3\frac{1}{2}$  c.

Broken lots No. 2,  $5\frac{1}{2}$  to  $5\frac{3}{4}$  c.

Carload lots No. 1,  $5\frac{1}{2}$  to  $6\frac{1}{4}$  c.

Broken lots No. 1, 6 to  $6\frac{3}{4}$  c.

Wrappings—

Manila B.,  $3\frac{1}{2}$  to  $3\frac{3}{4}$  cents.

Fibre,  $3\frac{3}{4}$  to 4c.

No. 2 Manila,  $3\frac{1}{2}$  c.

No. 1 Manila,  $3\frac{3}{4}$  to  $4\frac{1}{4}$  cents.

Kraft, 4 to  $4\frac{3}{4}$  cents.

Pulp—

Ground wood (at mill), \$17 to \$18.

Sulphite (bleached), \$51 to \$53.

Sulphite (unbleached), \$44 to \$45.

Waste Papers, per 100 lbs., f.o.b. Montreal—

No. 1 Hard White Shavings, \$1.65 to \$1.75.

No. 2 Hard White Shavings, \$1.65.

White Envelope Cuttings, \$1.65 to \$1.75.

No. 1 Soft White Shavings, \$1.60.

No. 2 Soft White Shavings, \$1.20.

No. 3 Soft White Shavings, 80c.

White Blanks, 80c.

Mixed Shavings, 35 to  $37\frac{1}{2}$  c.

Heavy Ledger, \$1.10.

Ordinary Ledger, \$1.00 to \$1.10.

No. 1 Flat Books, 75c. to 80c.

No. 1 Book Stock, 75c. to 80c.

No. 2 Book Stock,  $39\frac{1}{2}$  c. to 40c.

No. 1 Manila Envelope Cuttings, \$1.10.

Continued on Page xxviii.



## TIMBER FOR SALE

TENDERS will be received up to and including the first day of October, 1912, for the right to cut white and red pine and spruce, on two timber berths on the upper waters of the Jocko River east of the townships of Garrow and Lockhart, in the District of Nipissing, Province of Ontario, the berths being designated "Jocko No. I" and "Jocko No. II," each containing twenty-five square miles, more or less.

For maps and conditions of sale apply to the undersigned.

**W. H. HEARST,**

Minister of Lands, Forests and Mines.  
Toronto, July 17th, 1912.

# EMERSON MANUFACTURING CO.

LAWRENCE, MASS.

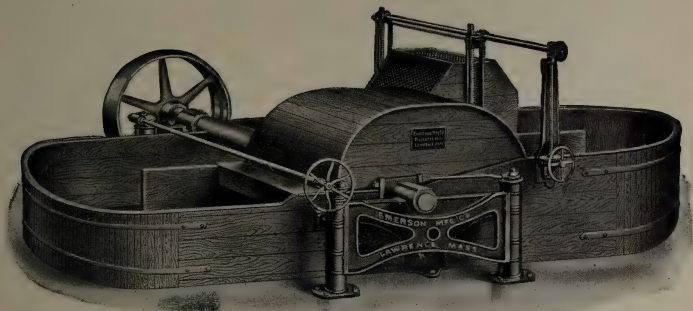

Beating and Washing Engines  
Paper Mill Machinery

**THE UNITED WIRE WORKS LTD,**  
EDINBURGH, GLASGOW & NEWCASTLE-ON-TYNE  
**FOURDRINIER WIRES, CYLINDER WIRES,**  
AND WIRE CLOTH OF ALL KINDS.  
AGENTS, ARTHUR P. TIPPET & CO 8 PLACE ROYALE MONTREAL.  
WIRES HELD IN STOCK AT MONTREAL FOR PROMPT DELIVERY.

## ARTHUR P. TIPPET & CO.

AGENTS AND IMPORTERS  
PAPER MILL SUPPLIES  
SULPHUR FELTS

SAL AMMONIAC, BORAX, SANTITIE, ETC.  
MONTREAL, TORONTO.



# Prime Canadian SPRUCE PULP

CHICOUTIMI, P.Q., - - CANADA



Supplied by the

**CHICOUTIMI  
Pulp Co.**

PRODUCTION:

**About 100,000 tons.**



Sole Agents:

**BECKER & CO.**

Limited

64 CANNON ST., LONDON



TELEGRAMS }  
CABLEGRAMS } MILNE, EDINBURGH

Code A B C 4th & 5th Editions.

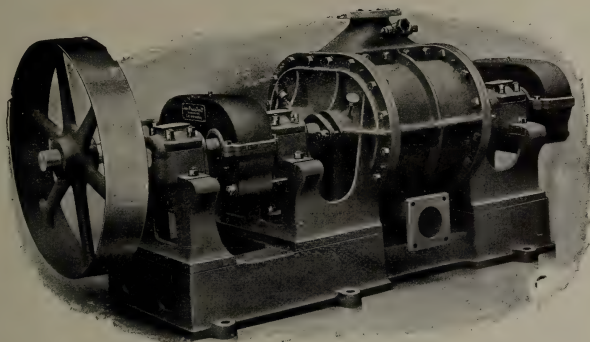

# HIGH DISPLACEMENT VACUUM PUMP

*(Made in Various Sizes)*

Suitable for

SUCTION ROLLS or VACUUM BOXES

MANUFACTURED BY

**JAMES MILNE & SON, LIMITED**

MILTON HOUSE WORKS, EDINBURGH

*DESIGNERS  
AND  
MANUFACTURERS  
OF HIGH CLASS  
PAPER MILL  
MACHINERY*

*FAST RUNNING  
PAPER MILL  
MACHINERY  
A SPECIALTY  
LEAST VIBRATION  
LEAST BREAKAGES*

*Don't Touch Your Mill Equipment Wit out Trying ilnc.*

- No. 1 Print Manilas, 65c.
- Railway Manilas, 50c.
- Folded News Overissues, 45c.
- Folded News, 45c.
- Crushed News, ..
- No. 1 Mixed Papers, 25c. to 30c.
- Rags (New and Old), per 100 lbs.—
- 1st Old White Cottons, \$2.00.
- 2nd Old White Cottons, ....
- Roofing Stock —
- Flock Satinets, 75 to 80c.
- Ordinary, 50 to 55c.
- Tailor Sweepings, 45 to 50c.
- No. 1 White Shirt Cuttings, \$4.75 to \$5.00.
- No. 2 White Shirt Cuttings, .... to .....
- Fancy Sheet Cuttings, \$3.65 to \$3.75.
- New Blue Prints, ... to ...
- New Blue Overalls, \$3.40 to \$3.50.
- New Black Overalls, \$1.60 to \$1.70.
- New Black Linings, \$1.60 to \$1.75.
- New Unbleached Cottons, \$3.75 to \$4.00.
- Bleached and Unbleached Shoe Clips, \$3.50.
- New Light Flannelettes, \$3.75 to \$4.40.
- New Light Shirt Cuttings, \$3.90 to \$4.35.
- Light and Dark Cords, ...

**COPYING PAPERS.**

Good copying paper must be well closed and strong; it must not cockle on dampening, but must absorb the water easily and uniformly so as to give a clear copy. The best results are obtained by the use of rags, together with shavings and broke of the same kind of paper. In response to the demand for cheapness, the writer has used a certain proportion of cold-bleached poplar or birch pulp. The rags are boiled in the ordinary way and broken in to give a three-quarter stuff. The breaker is fitted with fairly sharp tackle and the rags are carefully and slowly washed, then drawn out and lastly beaten to the required shortness. The soda wood pulp and the pulped shavings may then be mixed with the rag stock. A refiner is used to equalize the fully beaten stuff and improve the structure and look-through of the paper.

In beating, the limits between free and wet stuff must be carefully watched and the stuff must be refined until free from knots. An experienced beaterman will be able to keep the stuff regular by intelligent use of the needle, the hand-bowl or Klemm's sedimentation tester. The new copying paper in rolls particularly requires perfectly regular stuff. The slits of the strainer plates are 0.5 mm. wide and a No. 90 wire is best for the machine. The shake should work with a long and very rapid stroke; the couch-roll jacket and the rubber covering of the bottom press rolls should be maintained in perfect condition. Granite top press rolls are strongly recommended for this class of paper. Instead of the vertical felt on the second press, a second horizontal felt press is preferred. The first drying cylinder should only be gently heated in order to avoid blisters and to ensure flatness. For a speed of 230 feet per minute, 9 cylinders of about 4 feet diameter are sufficient, woollen dry felts being used. Good results are obtained by omitting the intermediate calenders, which in this class of work are always uncertain, and increasing the number of machine calender rolls from 3 to 5. The use of the intermediates necessitates exactly the right amount of dryness in the paper, which is not always obtainable when the felts are changed. If the paper is too moist its pores becomes closed and a greasy appearance may be developed on the surface. The writer cites two kinds of furnish which are used by him for the manufacture of copying papers (1) 60 per cent. of bleached cotton, 20 per cent. of bleached linen, 10 per cent. of tissue shavings, 10 per cent. of broke; (2) 20 per cent. of bleached cotton, 20 per cent. of bleached poplar (soda process), 20 per cent. of bleached birch cellulose, 20 per cent. of bleached spruce cellulose, 10 per cent. of tissue shavings, 10 per cent. of broke.

**The PULP & PAPER TRADING CO.**

TEMPLE COURT BUILDING, NEW YORK CITY.  
DEALERS IN

**Paper and Pulp of All Kinds.**

Prices and Samples on Application.

Telephone: 2726 BROAD.

Cable Address: "LAGERLOF NEWYORK."

# Scandinavian-American Trading Company,

PRODUCE EXCHANGE BUILDING, NEW YORK,

IMPORTERS AND EXPORTERS OF

FOREIGN AND DOMESTIC

# WOOD PULP

OF ALL KINDS

AND

# PAPER MILL SUPPLIES.

HANS LAGERLÖF, PRES.

ALL KINDS OF  
 Machines for Paper, Pasteboard,  
 Cardboard, Cellulose  
 and Pulp Mills

Paper Machines      Calenders  
 Winders              Calender Roll Lathes  
 Filters (Füllner's Construction)  
 Cutters              Cone Refiners  
 High Power Grinders   Patent Beaters  
 Edge Runners

FIRST-CLASS REFERENCES

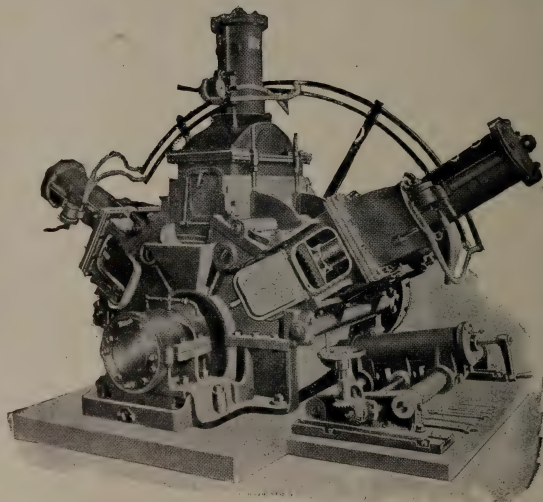

MOST MODERN CONSTRUCTIONS

Founded 1854

**H. FÜLLNER**

WARMBRUNN  
SILESIA  
GERMANY

Prizes won at all exhibitions where machines have been shown.  
 Turin 1911 "Grand Prize." Paris 1900 "Grand Prix" und "Kreuz der  
 Ehrenlegion." Leipzig 1897 "Gold Medaille." Paris 1907 "Grand Prix."

# CLASSIFIED ADVERTISERS' INDEX

If you fail to find what you want in these columns, write us and the desired information will be gladly supplied

## Architects and Engineers

Ambursen Hydraulic Con.  
Co.  
T. Linsey Crossley  
J. A. DeCew  
Eaton & Brownell  
Geo. F. Hardy  
Herbert S. Kimball  
International Process Co.  
Arthur D. Little, Inc.  
R. S. Lea & H. S. Ferguson  
Lyford, Clark & Lyford  
H. B. Prather  
Chas. B. Pride  
T. Pringle & Son  
Stebbins Eng. & Mfg. Co.  
R. O. and W. G. Sweezy  
Jos. H. Wallace & Co.

## Barkers.

Carthage Machine Co.  
Green Bay Barker Co.  
Jenckes Mach. Co.  
Waterous Engine Works.

## Beaters.

Dillon Mach. Co.  
Emerson Mfg. Co.  
H. Fullner  
Holyoke Mach. Co.  
E. D. Jones & Sons Co.  
Valley Iron Works  
Waterous Engine Works

## Beater Rolls.

J. A. DeCew  
J. Marx & Co.

## Belting.

Dom. Belting Co.  
F. Reddaway & Co.  
Sadler & Haworth

## Bleaching Powders.

Brunner, Mond & Co.  
Hooker Electro-Chemical  
Co.  
Winn & Holland

## Boilers.

John McDougall Caledonian Iron Works

## Brass Wire Cloth, Found-

rier Wires.  
Geo. Christie, Ltd.  
Herman Finckh  
C. H. Johnson & Sons,  
Ltd.  
Jas. Taylor  
A. P. Tippet & Co.  
United Wire Works  
P. P. Westbye

## Camel Hair Belting.

F. Reddaway & Co.

## Calender Rolls.

Farrel Foundry & Mach.  
Co.

## Chemicals, Colors, Etc.

Brunner, Mond & Co.  
Gewerkschaft Sachtleben  
A. Klipstein & Co.  
Hooker Electrochemical  
Co.  
Paper Makers' Chemical  
Co.  
A. P. Tippet & Co.  
United Alkali Co.  
Wilson-Paterson Co.  
Winn & Holland

## China Clay.

China Clay Co.  
A. Klipstein & Co.  
C. A. Meincke & Co.  
Paper Makers' Chem. Co.  
Wilson-Paterson Co.

## Chippers.

Carthage Machine Co.

## Conveying Machinery.

H. W. Caldwell & Son Co.  
M. Garland Co.  
Jeffrey Mfg. Co.

## Digester Lining.

Panzl Digester Lining Co.  
Preston's Digester Lining  
Co.  
Stebbins Eng. & Mfg. Co.

## Digesters.

Schaeffer & Budenberg  
Mfg. Co.  
Swenson Evaporator Co.

## Drainer Bottoms.

Samuel Snell Co.

## Evaporators.

Ernest Scott & Co.  
Swenson Evaporator Co.  
Zaremba Company.

## Exporters.

Parsons Trading Co.

## Felts.

F. Bredt & Co.  
Dallyn, Jardine & Co.  
Hamelin & Ayers Co.  
C. H. Johnson & Sons,  
Ltd.  
Penman's, Ltd.  
Joseph Porritt & Sons.  
J. H. Spencer & Sons.  
A. P. Tippet & Co.

## Fourdriners Wires.

(See Brass Wire Cloth.)

## Grinders.

Carthage Machine Co.  
H. Fullner.  
Glens Falls Mach. Co.

Holyoke Machine Co.  
Jenckes Machine Co.  
J. M. Voith  
Waterous Engine Works

## Knives.

Crookes, Roberts & Co.  
Peter Hay Knife Co.  
A. P. Tippet & Co.

## Paper Mills.

Canada Coating Mills.  
Canada Paper Co.  
New Brunswick P. & P.  
Co.  
Rolland Paper Co.  
Riordon Paper Co.

## Paper Presses.

Can. Boomer & Boschert  
Press Co.

## Paper and Pulp Dealers.

Atterbury Bros.  
Albert E. Mallandain.  
Castle, Gottheil & Over-  
ton  
Churchill & Sim  
Howell Co.  
Parsons Trading Co.  
Pulp and Paper Trading  
Co.

## Paper Stock, Rags, Etc.

Atterbury Bros., Inc.  
J. Christie Co.  
R. Hough  
The Howell Co.  
E. Pullan  
J. R. Walker & Co.

## Paper and Pulp Mill Machinery.

Appleton Machine Co.  
Beloit Iron Works  
Bentley & Jackson  
James Bertram & Son,  
Ltd.  
Bertram's, Limited  
The Black-Clawson Co.  
Canadian Boving Co.  
Carthage Machine Co.  
Chambers & Simpson  
Dillon Machine Co.  
Emerson Mfg. Co.  
Farrel Foundry & Ma-  
chinery Co.  
H. Fullner.  
Julius Fischer  
Glens Falls Machine Wks.  
Green Bay Barker Co.  
Harmon Machine Co.  
J. H. Horne & Sons Co.  
Holyoke Machine Co.  
Jenckes Machine Co.  
E. D. Jones & Sons Co.  
C. H. Johnson & Sons,  
Ltd.  
Marx, J. & Co.  
Jas. Milne & Sons  
Moore & White Co.



- B. F. Perkins & Son  
Rice, Barton & Fales  
Ryther & Pringle  
Sandy Hill Iron & Brass  
Works  
Ernest Scott & Co.  
Sheldons, Ltd.  
Sherbrooke Machinery  
Co., Ltd.  
S. Morgan Smith Co.  
Stebbins Engineering &  
Mfg. Co.  
H. F. Storrer  
Swenson Evaporator Co.  
Ticonderoga Machine  
Works  
Valley Iron Works  
J. M. Voith  
Charles Walmsley & Co.  
Chr. Wandel  
Wandel Screen Mfg. Co.  
Waterous Engine Works  
Co., Ltd.  
P. P. Westbye  
West End Engine Wks. Co  
Zaremba Co.
- Pipes (Wooden).**  
National Pipe & Foundry  
Co., Ltd.
- Pulp Stones.**  
Stancliffe Estates Co.  
Ltd.
- Pumps.**  
Can. Boving Co.  
Carthage Machine Co.  
Dillon Machine Co.  
Lawrence Machine Co.
- Lawrence Pump & En-  
gine Co.  
John McDougall Caledon-  
ian Iron Works.  
Smart-Turner Mach. Co.
- Rosin Size.**  
Paper Makers Chemical  
Co.  
Vera Chemical Co.  
Wilson-Paterson Co.
- Scales.**  
Alfred H. Mardon
- Screen Plates.**  
Union Screen Plate Co. of  
Canada
- Screens.**  
Glen Falls Machine Wks.  
Harmon Machine Co.  
Sherbrooke Machinery Co.  
J. M. Voith.  
Chr. Wandel  
Wandel Screen Mfg. Co.  
Waterous Engine Works  
P. P. Westbye
- Slitters and Re-Winders.**  
H. Fullner  
Moore & White Co.  
Ticonderoga Mach. Co.
- Sulphur.**  
Union Sulphur Co.
- Talc.**  
Geo. H. Gillespie Co.
- Tanks.**  
John McDougall Caledon-  
ian Iron Works
- Transmission Machinery.**  
H. W. Caldwell & Son Co.  
Jones & Glasco  
Dodge Manufacturing Co.
- Travelling Cranes.**  
Hugh R. Bletcher  
Northern Crane Co.  
Smart-Turner Mach. Co.
- Turbines.**  
J. M. Voith  
S. Morgan Smith Co.
- Water Wheels.**  
John McDougall Caledon-  
ian Iron Works  
Holyoke Machine Co.
- Wire Cloth for Paper Ma-  
chines.**  
Scottish Wire Cloth Co.,  
Ltd.
- Wood Pulp Agents.**  
Castle, Gottheil & Over-  
ton  
Churchill & Sim  
Parsons Trading Co.  
Scandinavian Amer. Trad-  
ing Co.



## LINK BELTING

Made of

**STRONG, CLEAN MALLEABLE CASTINGS**  
Accurate Pitch - All tested before leaving shop

*Prompt Shipments from Our Large Stock*

We also manufacture :

**SAWDUST and REFUSE CHAINS,  
PULLEYS, SPROCKET - WHEELS  
BEARINGS, ETC.**

**ELEVATOR BUCKETS STEEL and  
MALLEABLE IRON**

All sizes and gauges carried in stock

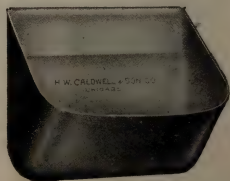

## H. W. CALDWELL & SON CO.

CHICAGO : 17th St. and Western Ave.  
NEW YORK : Fulton Building, 50 Church St.

# J. H. Horne & Sons

COMPANY

Lawrence - - - Mass.

---

---

MANUFACTURERS OF

## PAPER MILL MACHINERY

---

---

Fourdriniers	Horne Jordan Engines
Cylinders and	Double Bevelled Roll Bars
Wet Machines	Horne Friction Cullers
Improved Horne Engines	Barbed Jordan Bars

SEND FOR CATALOGUE

# THE MULLEN TEST

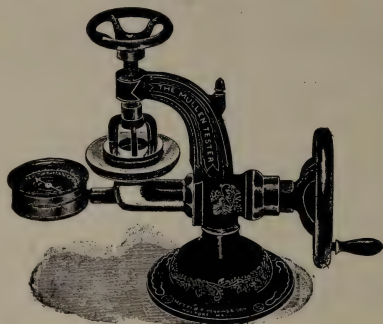

Is specified by all the Freight Classification Committees on all Fibre Board and Corrugated Board Packing Cases. For this you require the Jumbo Mullen Tester, which is merely a larger size of the regular Mullen Paper Tester. This Machine will test the strength of all Boards up to 1,000 pounds per square inch. *Send for Catalog and References.*

SOLE MANUFACTURERS

**B. F. PERKINS & SON, Inc. - Holyoke, Mass.**

European Agents: Parsons Trading Co., - New York and London

**FROZEN PULP AND DRY PULP  
IN A**

## Ryther Shredder

Is shredded at the rate of 5 tons per hour.  
17 to 25 H. P. required. The above figures are  
*dry weight* and absolutely guaranteed.

RELIEVE YOUR BEATERS and INCREASE QUALITY  
and PRODUCTION. Write for full Particulars.

---

**Ryther & Pringle Company**  
Carthage, N.Y.

# BLAKE SIMPLEX PUMPS

*FOR BOILER FEED AND PRESSURE SERVICE*

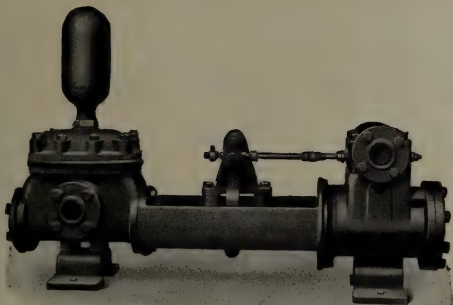

A 250 lb. PRESSURE PUMP  
—FOR—

A 150 lb. PRESSURE PRICE

---

---

**THE JOHN M<sup>C</sup>DOUGALL  
CALEDONIAN IRON WORKS CO.  
LIMITED**

**WORKS—WILLIAM AND SEIGNEURS STREETS, MONTREAL**

Manufacturers of Boilers, Castings, Condensers, Elevators, Engines, Filters, Forgings, Hydraulic Machinery, Pulleys, Pumps, Centrifugal and Reciprocating, Steam Turbines, Shafting, Tanks, Water Wheels, Water Works Plants.

**PRESTON'S**

# Lining for Sulphite Digesters

TOTAL THICKNESS ONLY 2¼ TO 2¾ INCHES

Resists the action of the acid and ensures absolute protection to the Digester Plates.

Great durability, therefore large saving in upkeep and repairs.

Larger internal space and increased production on account of the small thickness occupied.

Extensively adopted by Scandinavian and Continental Mills.

Over 200 Digester Linings in work and on order.

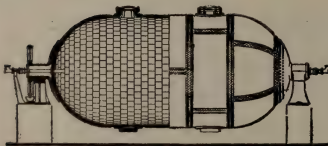
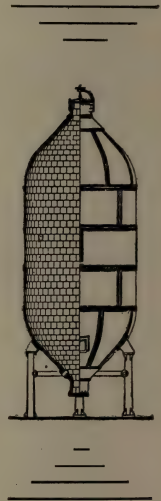

Telegraphic Address :

**"PRESTONS, RADCLIFFE."**

CODE USED A. B. C., 4TH & 5TH EDITION.

*Full Particulars and Prices on application to SOLE MANUFACTURERS*

**PRESTON'S DIGESTER LINING CO., LIMITED**

**RADCLIFFE, near Manchester, Eng.**



---

---

FARREL FOUNDRY AND MACHINE  
COMPANY

ANSONIA, CONN., - - U. S. A.

Largest Manufacturers in the world of

**CHILLED ROLLS**

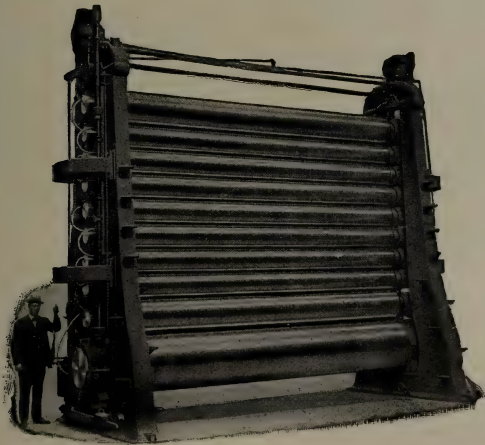

**CALENDERS**

*WITH PATENT HYDRAULIC LIFT*

**ROLL GRINDING MACHINES**

---

---

*Would YOU like to enlarge your Business and find new Customers in all parts of the world? If so, ADVERTISE in*

# “THE PAPER-MAKER AND BRITISH PAPER TRADE JOURNAL.”

THE LEADING AND MOST POPULAR TRADE ORGAN.

**THE ADVERTISER IS GOOD FOR THE READER**

We recently received the following letter:—

“We have hesitated over the matter, as we are at present so busy as to regard further advertising as almost superfluous.

“On the whole, however, we find it pays us better to have to refuse orders than to hunt after them, and will ask you therefore to insert our advertisement on same terms as last.

“We enclose herewith amended matter for advertisement, and shall be glad to have proof of same at your early convenience.”

We are constantly in the receipt of gratifying letters relative to the usefulness of our Journal, and we have pleasure in printing the following:

“Gentlemen,

We beg to advise that we have not as yet received the June number of ‘THE PAPER-MAKER AND BRITISH PAPER TRADE JOURNAL.’

We like the publication so well that we should be very sorry indeed to miss a copy of it.

Thanking you in advance for your kind attention,

We are, dear Sirs, yours very truly,  
F. R. KEYES & SON.  
20 Broad Street, New York.”

## S. C. PHILLIPS & Co.'s STANDARD PUBLICATIONS

### The Paper-Maker

AND BRITISH PAPER TRADE JOURNAL.

Published on the 1st of each month. Price 1s., by post 1s. 6d. Annual Subscription 12s. 6d. post free.

**The Stationery World,  
Printing and Allied Trades,  
AND FANCY GOODS REVIEW.**

Published on the 25th of each month. Price 6d. by post 7½d. Annual Subscription 5s. post free.

Chief Offices:

### The Paper Box and Bag Maker.

Published on the 19th of each month. Price 6d., by post 7½d. Annual Subscription 6s. 6d. post free.

**Phillips' Paper Trade Directory  
of the World.**

15s. 6d., post free to all countries.

NEW EDITION FOR 1911 NOW READY.

Specimen Copies and Advertisement Rates  
FREE OF APPLICATION.

47 CANNON STREET, LONDON, E.C. (ENGLAND).

# PAPER and CLOTH Specialties

*For Rent and Club Cards, Pattern Cards, Map Printing, Label Printing, Envelopes, etc., etc.*

Cloth Lined Papers. Cloth Centred Papers and Boards. Cloth Lined, Chromo and Enamel. Cloth Lined Boards and Cards (surfaced and enamelled). Cloth Centred Boards (surfaced and enamelled). Manilla Surfaced Boards and Cards.

**Also Enamelled Blotting. Art Papers. Paste Boards. Chromo and Surface Papers**

Customers' requirements in specialties are carefully considered and experiments conducted if necessary.

---

## ALBERT E. MALLANDAIN

OFFICES: 51 Cheapside  
London, E.C.

MANUFACTURER

MILLS: Park Royal  
Willesden, London, N.W.

## E. H. WILKINSON

Telephone Building  
82 Adelaide Street West  
Toronto

*Sole Agent for Canada*

Telephone Main 1716  
Cable Address: *Faultless*

---

# HERMANN FINCKH

REUTLINGEN

*Established 1879*

GERMANY

---

# FOURDRINIER WIRES

---

**SULPHITE - MACHINE WIRES**  
**CYLINDER WIRES**

---

**P. P. WESTBYE, - Peterborough, Ontario**

*Sole Agent for Canada*

## WANT AND FOR SALE ADVERTISEMENTS

**AGENT WANTED** to represent in Canada an old established firm of English Felt Makers. Only reliable firms calling personally and periodically on Paper Mills need apply. Box 811, c-o The Paper Maker, 47 Cannon Street, London, E. C., England.

**PRODUCTION ENGINEER:** Mechanical and consulting, sulphite and paper mill expert, 31 years of age, first-class designer and pulp chemist, wants only well paid position in Canada or United States. Apply Box 34, Pulp and Paper Magazine.

**PULP MILL CHEMIST** with twelve years' experience in Sulphite (Bleached and Unbleached), wants similar position, good draughtsman. Apply Box 30, Pulp and Paper Magazine.

**UNDER MANAGER.**—Young man, 14 years' practical experience in English mill making long elephants, news, all-wood printings, cream laid, etc. Experienced mill chemist—testing of papers, fibres, etc. Highest references. Address H. C., c/o Pulp and Paper Magazine.

**WANTED IMMEDIATELY.**—Master mechanic, machinists, millwrights, and pipefitters for Canadian soda, pulp and paper mill now under construction. Only experienced men need apply. State wage and give references. Apply Box D, Pulp and Paper Magazine.

**THE PAPERMAKERS' POCKET BOOK**—By James Beveridge—Specially compiled for Paper Mill Operatives, Engineers, Chemists and Officials. Price \$3.50. Biggar-Wilson, Ltd., Toronto.

### FOR SALE.

**BELTING.**—1,000,000 ft. New Leather Rubber and Cotton Belting; 500,000 feet Iron Pipe; large stock of Pulleys, Shaftings, Hangers, Saws, Wire Fencing, Roofing, Rails, etc. Catalogue on request. Price 25 to 75% cheaper than elsewhere. The Imperial Waste and Metal Co., 105 Queen St., Montreal, Que.

**FOR SALE.**—Special Second-hand cylinder mould, 48-in., diameter 84-in. face. Good as new. Can be used as Filter. For particulars, etc., address Box 32, Pulp and Paper Magazine.

As we are using all our Water Power at our Pulp Mill for electricity, we are disposing of the Pulp Mill Machinery—including Millard Patent Grinders which were in use only a few months and are absolutely as good as new, also Wet Machines, Barkers, Screens, Pumps, Piping, Shafting, Stones, etc., etc., all in good condition. Full information will be given upon application.

Apply Box "A,"

Pulp and Paper Magazine.

**WANTED.**—Manager for paper mill on Pacific Coast, making wrapping, sheathing and building paper and box board. Must have practical and business experience and be capable of taking full charge of operations. Apply in confidence giving full particulars of experience, with references, and stating salary required.—Box No. 33, Pulp & Paper Magazine.

 The Canadian Pulp and Paper Directory for 1912,  
 Price, \$3.00  
 Biggar-Wilson, Ltd., Toronto

SCOTT'S IMPROVED RECOVERY SYSTEMS  
FOR  
**SODA, SULPHATE & SULPHITE**

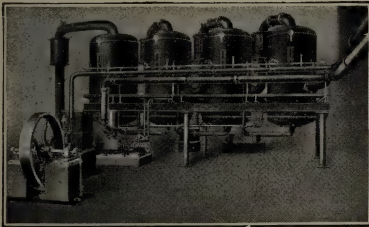

Spent Liquors give the  
MAXIMUM ECONOMY  
AND EFFICIENCY

The PRINCIPLE,  
The DESIGN,  
The CONSTRUCTION,  
The OPERATION,  
The RESULT,

**Is RIGHT**

Complete installations made by "THE FIRM WITH THE EXPERIENCE."

**ERNEST SCOTT & CO.** Manufacturing  
Engineers

FALL RIVER, MASS. and MONTREAL, P.Q.

**SODA OR SULPHATE**

RECOVERY SYSTEM  
MAXIMUM EFFICIENCY      MINIMUM LOSSES

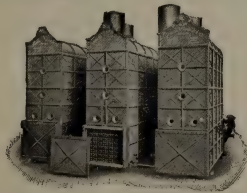

WELDED DIGESTERS      MULTIPLE EFFECT EVAPORATORS  
AND OTHER PULP MILL EQUIPMENT

**SWENSON EVAPORATOR CO.**

945 Monadnock Bldg. . . . CHICAGO



# HEATING FAN

with Vertical Enclosed  
Forced Lubricating  
Engine for Textile and  
Pulp and Paper Mills

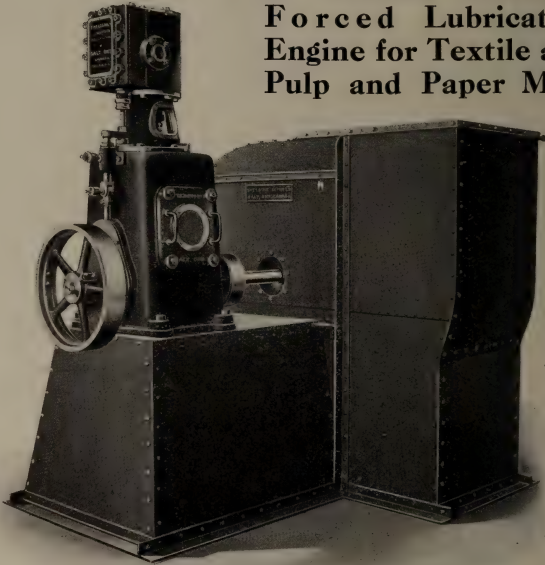

We also make appliances for Exhausting Steam and Foul Air, Heating and Ventilating, Air Cooling Systems, Callander Blowers and Piping, etc.

---

**SHELDONS LIMITED**  
GALT - - - ONTARIO

Toronto Office : 609 Kent Bldg.

Agents : Ross & Greig, 412 St. James St., Montreal, Canada.

Grose & Walker, 259 Stanley St., Winnipeg, Man.

R. Hamilton & Co., Bank of Ottawa Bldg., Vancouver, B.C.

VALLEY IRON



WORKS COMPANY

# BEATING AND WASHING ENGINES

IRON OR WOOD TUBS

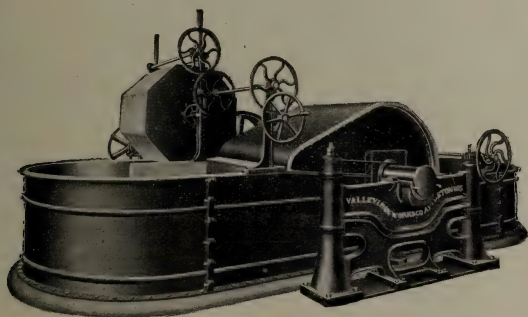

*Perfection in Every Detail*

Beating, Washing and Bleaching Engines. Barkers—Barker Attachments  
—Chippers—Rechippers—Chip Screens (Revolving)—

Knot Screen (Revolving)—Diaphragm Screens—Felt Washers—Deckers  
(Single and Double)—Stuff Chests (Vertical and Horizontal)—

Tanks (Blow Off, Acid and Water)—Pulpwood Saws (Friction and  
Steam Feed)—Pulpwood Splitters (Vertical and Horizontal)—

Shredders and Special Washers for old Paper Stock—Wet Machines and  
Patent Roll Skinners—Bronze, Semi-Steel, Lead and Iron Castings.

**Manufacturers of Paper and Pulp Making Machinery in**

*All Standard Forms — Many Special Designs*

**ENGINEERS, FOUNDERS AND MACHINISTS**

*Correspondence Invited*

**VALLEY IRON WORKS COMPANY**

**APPLETON, WIS., U.S.A.**

# TOWNSEND

## ELECTROLYTIC CELL

2,500-5000 AMPERE UNITS. ALKALI AND CHLORINE.  
CAUSTIC SODA. BLEACHING POWDER. CHLORINE  
FOR ORES. LICENSES GRANTED. CANADIAN PATENTS  
91939 - 105088 - 105089.

**HOOKER ELECTROCHEMICAL COMPANY**  
40 WALL STREET, NEW YORK

REGISTERED



JOHN KNIGHT, Pres. C. K. WILLIAMS, Treas. C. H. KNIGHT Sec.

## Paper-Makers Chemical Co.

FROM MINE TO MILL

**ENGLISH CHINA CLAYS  
MANUFACTURERS**

**Excelsior Felt Cleaner**

GBB Brand China Clay is  
a natural pure white, no artificial tinting Superior Rosin Size  
Unsurpassed for coating, bleaching, or fine papers. Superior Satin White

**EASTON, PA., U.S.A.**

## Paper Coating and Colouring Machines

COMPLETE PLANTS AND ACCESSORIES

The best in the world.

To be obtained from

**Julius Fischer Engineering Works Nordhausen, H.**

GERMANY

*Excellent References in all countries.*

**THE PETER HAY KNIFE CO., Limited, GALT, ONT.**

MACHINE  
KNIVES,  
CHIPPER,  
BARKER &  
PAPER-  
CUTTER  
KNIVES.



Made from the Best English Steel and Warranted.

Established  
1869

**CHR. WANDEL**

Established  
1869

REUTLINGEN

GERMANY

Paper Machine Wire and Engineering Works

SOLE MANUFACTURER OF

# The Original "WANDEL" Rotary Screen

Over  
3,000  
Apparatus  
Sold

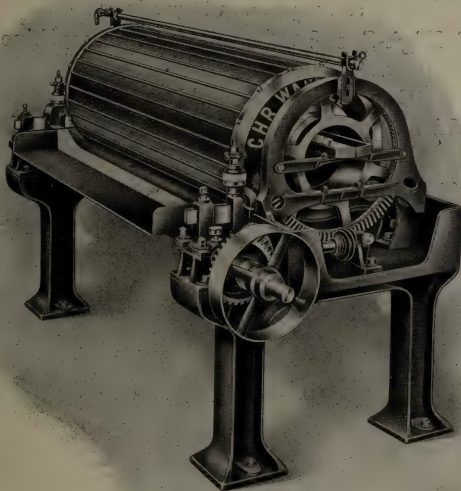

No authorized  
builder in  
Canada  
or the States

**ADVANTAGES :** *Regular output of pulp. Large working ability. Automatic removal of knots. Avoidance of stoppage. Less power. Great strength and durability. Suitable for all classes of paper.*

ESTIMATES PROMPTLY FURNISHED, DELIVERED AT ANY POINT

SOLE CANADIAN AGENTS

**ARTHUR P. TIPPET & CO.**

8 Place Royale

Montreal, Que.

# CROOKES, ROBERTS & Co.

SHEFFIELD

ENGLAND

Makers of

Makers of

Crucible Cast Steel

Bessemer Cast Steel

Bed Plates

Crookes'

Jordan Fillings

Composition

Beater Bars

Fillings



And every description of Cutter Knives, Tools and Steel used and required in Paper Mills.

**ARGUS** High-Speed **STEEL** for fine machine tools is unsurpassed.

Once Used - Always Used

YOU SAVE MONEY USING "ARGUS" GOODS

WRITE US

**ARTHUR P. TIPPET & CO.**

Agents for Canada

MONTREAL

# SPENCER'S

ALWAYS

RELIABLE



Best Wool - Best Weave - Best Wear

**J. H. SPENCER & SONS**

BURY

ENGLAND

Canadian Agents: **ARTHUR P. TIPPET & CO., MONTREAL**



# INDEX TO ADVERTISEMENTS.

(SEE CLASSIFIED ADVERTISERS INDEX ON PAGE XXXI.)

Ambursen Hydraulic Construction Co.	lxv	Dodge Mfg. Co.	iv
Appleton Machine Co.	iv	Dominion Belting Co.	xlviii
Atterbury Bros. Inc.	lxii	Eaton & Brownell	lviii
Becker & Co.	xxvi	Emerson Mfg. Co.	xxxv
Beloit Iron Works	xiii	Farrell Foundry & Machine Co.	xxxvii
Bentley & Jackson	v	Ferguson, H. S.	lviii
Bertram, James & Son, Ltd.	xviii	Fischer, Julius	xliv
Bertram's, Limited	vi	Finckh, Hermann	xxxix
Black-Clawson Co., The	x	Finstedt Gustaf	lxi
Blethen, Hugh R.	lix	Fullner, H.	xxx
Bredt & Co., F.	lii	Caldwell, H. W. & Son, Co.	xxxii
Brunner, Mond & Co., Limited	lxvi	Canada Coating Mills, Limited.	lvii
Canada Paper Co., Ltd.	lvii	Canada Paper Co., Ltd.	lvii
Canadian Boomer & Boschert Press Co.	lx	Canadian Boomer & Boschert Press Co.	lx
Canadian Boving Co.	lv	Canadian Boving Co.	lv
Carthage Machine Co.	xxiv	Carthage Machine Co.	xxiv
Castle, Gottheil & Overton	lii	Castle, Gottheil & Overton	lii
Chambers & Simpson	vi	Chambers & Simpson	vi
Chicoutimi Pulp Co.	xxvi	Chicoutimi Pulp Co.	xxvi
China Clay Co.	l	China Clay Co.	l
Christie, J. Co.	lxvi	Christie, J. Co.	lxvi
Christie, Limited, George	lxv	Christie, Limited, George	lxv
Churchill & Sim	lxii	Churchill & Sim	lxii
Crookes, Roberts & Co.	xlvi	Crookes, Roberts & Co.	xlvi
Crossley, T. L.	lviii	Crossley, T. L.	lviii
Dallyn, Jardine & Co.	lii	Dallyn, Jardine & Co.	lii
Dean & Son, Ltd.	liv	Dean & Son, Ltd.	liv
De Cew, J. A.	lix	De Cew, J. A.	lix
Dillon Machine Co.	xiv	Dillon Machine Co.	xiv
Garland, M. Co.	xii	Garland, M. Co.	xii
Gewerkschaft, Sachtleben	lxiii	Gewerkschaft, Sachtleben	lxiii
Gillespie, Geo. H. Co.	lxv	Gillespie, Geo. H. Co.	lxv
Glens Falls Machine Works	xliv	Glens Falls Machine Works	xliv
Green Bay Barker Co.	xxi	Green Bay Barker Co.	xxi
Hamelin, The, & Ayers Co., Ltd.	lx	Hamelin, The, & Ayers Co., Ltd.	lx
Hardy, Geo. F.	lviii	Hardy, Geo. F.	lviii
Harmon Machine Co.	viii	Harmon Machine Co.	viii
Hay Knife Co., Peter, Limited	xliv	Hay Knife Co., Peter, Limited	xliv
Holyoke Machine Co.	xvi	Holyoke Machine Co.	xvi
Hooker Electrochemical Co.	xliv	Hooker Electrochemical Co.	xliv
Horn, J. H. & Son	xxxiii	Horn, J. H. & Son	xxxiii
Hough, R.	lxvi	Hough, R.	lxvi
Howell Co., The	xlviii	Howell Co., The	xlviii
Jeffrey Mfg. Co.	iii	Jeffrey Mfg. Co.	iii
Jenckes Machine Co.	xvii	Jenckes Machine Co.	xvii
Johnson & Sons, Limited, C. H.	xlx	Johnson & Sons, Limited, C. H.	xlx

## HYDRAULIC TURBINES

One unit of six with a total capacity of 13,100 Horse Power furnished for the new plant of J. R. Booth, Ottawa, Ontario. We build Turbines for any power for heads from 3 to 600 feet.

WRITE FOR CATALOGUE



**S. MORGAN SMITH CO.,**  
**YORK - PA.**

Jones, E. D. & Sons Co. ....liv	Rolland Paper Co., .....lvi
Jones & Glassco .....xx	Ryther & Pringle .....xxxiv
Kimball, Herbert S. ....lviii	Sadler & Haworth .....liiii
Klipstein & Co., A. ....1	Sandy Hill Iron & Brass Works .....x
Lawrence Machine Co. ....xx	Scandinavian American Trading Co. ....xxix
Lawrence Pump & Engine Co. ....lii	Schaeffer & Budenberg Mfg. Co. ....lxiii
Lea, R. S. & H. S. Ferguson .....lviii	Scottish Wirecloth Co. ....xlviii
Little, Arthur D. Inc. ....lviii	Scott, Ernest & Co. ....xli
Lyford, Clark & Lyford .....lviii	Sheldons Ltd. ....xlii
Mallandain, Albert E. ....xxxix	Sherbrooke Machinery Co., Limited. ....xix
Marx, J. & Co. ....viii	Smart-Turner Machine Co. ....lxvi
Mardon, Alfred H. ....lx	Smith, S. Morgan, Co. ....xlvii
McDougall, John, Caledonian Iron Works Co., Limited .....xxxv	Snell, Samuel Co. ....1
Meincke, C. A. & Co. ....1	Spencer, J. H. & Sons .....xvii
Milne, Jas., and Son. ....xxvii	Stancliffe Estates Co., Ltd. ....lxiii
Moore & White Co. ....xv	Stebbins Engineering & Mfg. Co. ....lix
National Pipe & Foundry Co., Ltd. ....1	Sweezey, R. O. & W. G. ....lviii
New Brunswick Pulp and Paper Co., Limited .....lv1	Swenson Evaporator Co. ....xli
Northern Crane Works, Ltd. ....lxvi	Taylor, J. A. ....lxv
Panzl Digester Lining Co. ....lvi	Ticonderoga Machine Works. ....e.o.m.
Paper Makers Chemical Co. ....xlv	Tippet, Arthur P. & Co. ....xxv-xlv-xlvi
Parsons Trading Co. ....xxiv	Union Screen Plate Co. ....iii
Penmans Limited .....lii	Union Sulphur Co., The. ....lxi
Perkins, B. F. & Son .....xxxiv	United Wire Works, Limited .....xxv
Phillips, S. C. & Co. ....xxxviii	Valley Iron Works .....xliii
Porritt & Son, Joseph .....lii	Vera Chemical Co. ....lxii
Porritt Bros. & Austin .....xlix	Voith, J. M. ....vii
Prather, H. B. ....lix	Walker, J. R. & Co. ....lxii
Preston's Digester Lining Co. Ltd. ....xxxvi	Wallace, Jos. H. & Co. ....lix
Frige, Chas. B. ....lix	Walmesley, Charles & Co. ....xxii-xxiii
Pringle, T. & Sons .....lviii	Wandel, Chr. ....xiv
Pullan, E. ....liv	Wandel Screen Mfg. Co. ....lx
Pulp & Paper Trading Co., The .....xxviii	Westerous Engine Works Co., Ltd. ....lxiv
Reddaway, F. & Co. ....liv	Westbye, P. P. ....xi-xxxix
Rice, Barton & Fales .....ii	West End Engine Works Co. ....li
Riordon Paper Co., Limited .....lvii	Wilkinson, E. H. ....xxxix-lxv
	Wilson-Paterson Co. ....xxiv
	Winn & Holland .....lxvi
	Zarembo Co. ....e.o.m.

**Scandinavian Sulphite  
and Ground Wood  
Kraft Pulp  
Bleached Sulphate  
and Sulphite  
Austrian Bleached  
Mitscherlich**

Limited quantities still available  
Write us for quotations and  
quantities

**THE HOWELL CO.**  
8-10 Wellington St. East  
**TORONTO - CANADA**

**MAPLE LEAF  
STITCHED COTTON DUCK  
BELTING  
DOMINION BELTING CO. LTD.  
HAMILTON CANADA**

**The Scottish Wirecloth**  
Company, Limited  
LEITH - - - - SCOTLAND  
Wirecloth for Paper Machines, etc.

# Glens Falls Machine Works

GLENS FALLS, N.Y.



Sole Manufacturers of  
**Tromblee & Paull Rotary Sulphur Burner**  
**The Moore Rotary Screen**  
**The Reynolds Screen**

Also Manufacture  
**Cedar Point Foundry Grinders**  
**Improved Standard Grinders**  
**Improved Wet Machines**  
**Rotary Pumps, etc.**

Write for Particulars and Specifications—they are free.

## C. H. JOHNSON & SONS, Ltd.

WIRE WORKS, ST. HENRY, MONTREAL.

MANUFACTURERS OF

**Fourdrinier Wires, Cylinder Wires,**  
**Brass, Copper and Iron Wire Cloth, Dandy Rolls**

## PORRITT BROS. & AUSTIN

Stubbins Vale Mills—RAMSBOTTOM—near Manchester, England

Manufacturers of every description of

**FELTS AND JACKETS FOR**  
**PULP AND PAPER MILLS**

Agents for Canada: C. H. JOHNSON & SONS, Ltd., ST. HENRY, MONTREAL

**WE MANUFACTURE Wooden Water Pipe** for Water Works Systems. **Specially Made Pipe** for conveying Chemicals. **Continuous Stave Pipe** or Power Plants.  
 Sizes from 2 inches to 12 feet diameter.

**NATIONAL PIPE AND FOUNDRY CO., LIMITED**

Works—ALEXANDRIA, Ont. 135 Board of Trade Bldg., MONTREAL, Que.

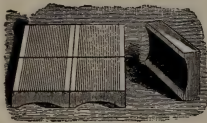

### Use Snell's Drainer Bottoms

They drain quickly and don't let the Pulp go into River. **No Dust. No Splinters. Clean Stock.**

*Send for Sample and Price*

**Samuel Snell Co., - Holyoke, Mass.**

Cable Address:—"Kaolin, Manchester." A.B.C. Codes 4th & 5th Edition

# CHINA CLAY CO.

JOHN WILLIAMSON, Manager.

4 St. Anne's Square

**MANCHESTER, ENG.**

MINES—Ruddle, Bojea, Colchester, South Ninestones, Tronance, St. Austen Cornwall.

CONTRACTORS TO H.M. INDIAN GOVERNMENT

Canadian Representatives—C. A. Meincke & Co., 222 Coristine Bldg., Montreal.

## A. KLIPSTEIN & Co. Ltd.

(OF CANADA)

12 ST. PETER ST. - - MONTREAL

# SULPHATE ALUMINA

**CHINA CLAY, BLEACH and CASEIN  
 PAPER BLUE, both Basic and Acid  
 AURAMINE - RHODAMINE**

and all other Aniline Colors

Shades Carefully Matched in our Laboratory Mention Pulp & Paper Magazine

New York Office - 644-654 Greenwich Street.



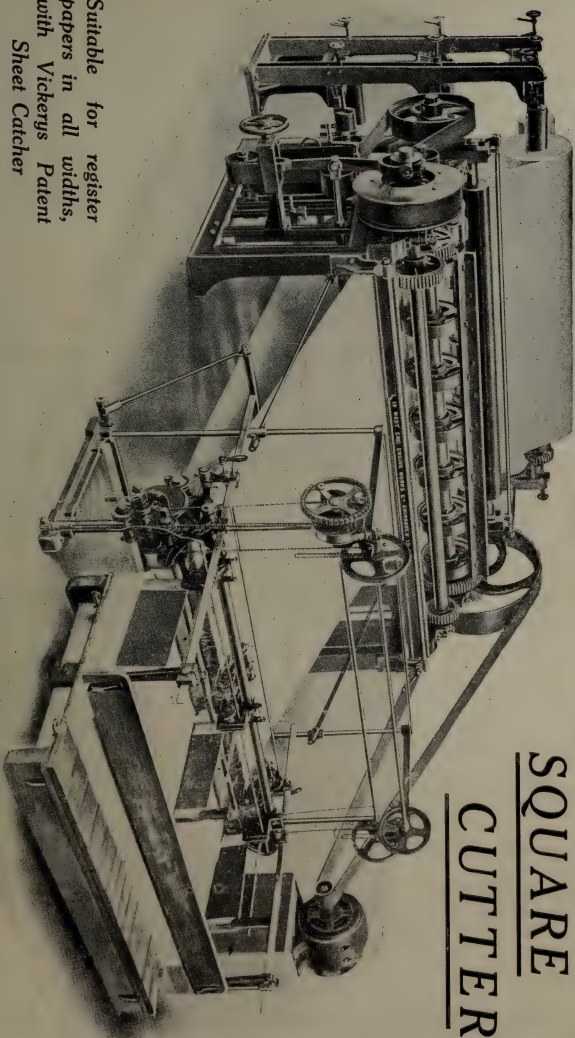

# SQUARE CUTTER

Suitable for register  
papers in all widths,  
with Vickers's Patent  
Sheet Catcher

MADE BY

THE WEST END ENGINE WORKS CO.

PAPER MAKERS' ENGINEERS

EDINBURGH  
SCOTLAND



**LAWRENCE PUMP  
AND ENGINE CO.**

P. O. BOX 70, DEPT. 10  
LAWRENCE :: MASS.

**CENTRIFUGAL PUMPS**

We make an exclusive specialty of High Efficiency Centrifugal Pumps for Paper and Pulp Mill. In one mill 49 of our Pumps are running, the customer writes—"Your Pumps are all giving perfect satisfaction."

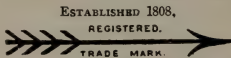
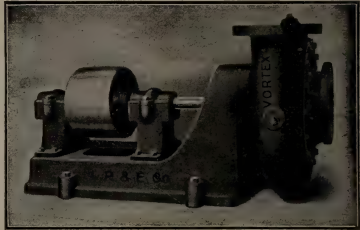

**FELTS** For Pulp and Paper Mills.

**JOSEPH PORRITT & SONS**

Agents for  
Canada  
and United  
States.

**HELMSHORE**

Manchester, England.

All kinds  
Woollen, Lin-  
en and Cotton  
Cloths for  
Mechanical  
Purposes.

**F. BREDT & CO., 240 Water Street, NEW YORK.**

**PENMANS LIMITED**  
ST. HYACINTHE, QUEBEC

Manufacturers of  
**PULP AND PAPER MAKERS' FELTS,  
JACKETS, STRAINER CLOTHS, ETC.**

Special sizes and qualities made to order. Satisfaction guaranteed.  
**DALLYN, JARDINE & CO. TORONTO Selling Agents**

**CASTLE, GOTTHEIL & OVERTON**

*200 Fifth Avenue, New York*

**AGENTS FOR**

***Sulphite and Wood Pulp Mills***

Dealers in all kinds of Paperstock, Sizing, etc.

Correspondence Solicited.

Remember  
This—



*Waterproof*

# Leather Belting

Costs less per day of service

MADE ONLY BY

*Sadler & Haworth*

*Tanners and Manufacturers*

**MONTREAL**

511 William Street

**TORONTO**

27 Melinda Street

**ST. JOHN, N.B.**

89 Prince William St.

**WINNIPEG**

244 Princess Street

**VANCOUVER**

217 Columbia Ave.

*For over thirty-five years the makers of the best leather belts*

Nearly FIFTY YEARS ago we introduced this Belt. IT HAS STOOD THE TEST OF TIME

2" to 24" in stock

Every Belt is  
Stamped with  
Trade-Mark.



Write or phone us

Beware  
of Imitations

SOLE MAKERS

F. REDDAWAY & CO.,

MONTREAL, CANADA.

**E. PULLAN,** 490 Adelaide St. W., **TORONTO**

Largest Paper Stock Dealer in Canada

**RAGS AND PAPER STOCK GRADED TO SUIT MILL REQUIREMENTS**

Correspondence Solicited.

EDWARD A. JONES, President and Treasurer

WALLACE E. BARDWELL, Secretary

**E. D. JONES & SONS CO., Pittsfield, Mass.**

Manufacturers of

**PAPER MAKING MACHINERY  
AND MECHANICAL ENGINEERS**

Beating Engines. Washing Engines. Mixing Engines. Bleaching Engines.  
Cooking Engines. Vertical and Horizontal Stuff Chests.

Jordan Engines of three sizes, either belt or direct connected motor driven;  
fillings of Wagg Steel or stone type, three-part or plain.

Dusting Machinery of all kinds.

**NEW EDITION FOR 1912 NOW READY**

A BOOK YOU ARE SURE TO WANT

PRINTED IN CLEAR TYPE

ALPHABETICALLY ARRANGED

# The Paper Maker's Directory of all Nations

Annuaire de la Papeterie de Toutes les Nations.

Internationales Adressbuch sämtlicher Papierfabrikanten der Welt

### Contents Include

Paper, Pulp and Board Mills. Names and Addresses of more than 5,000 in 40 different Countries, with (1) Makes of Paper; (2) Number and width of Machines; (3) Tonnage Output; (4) Power Used; (5) Telegraphic Addresses; (6) Agents, etc. Classified Lists of Principal Productions for each country. Special Buyers' Guide. Paper Agents and Mill representatives (with Mills represented). Paper stainers, Enamellers and Surfacers of Paper.	Wholesale Stationers and Paper Merchants. Waste Paper Merchants and Rag Merchants & Paper Stock Dealers. Export Merchant Shippers of Paper, Cardboard and Paper Box Manuf'rs. China Clay Merchants. Paper Bag Makers. Buyers' Guide. Sizes (with folds) of British Papers. Paper Trade Customs, Paper Equivalents, &c., &c., British Paper Trade Customs.
---	---

PRICE 10/6 NET, POST FREE 11/6

TO BE OBTAINED FROM

**DEAN & SON Ltd. - 160a Fleet St.  
LONDON, E.C.**

The Red Book of the  
British Paper  
Industry



Demy 8vo, Cloth Bound  
796 Pages



## ROLLAND'S PAPERS

For Business Stationery, for Loose Leaf Sheets and all kinds of printed or lithographed forms, include many textures at a wide price range. There is a paper for every need and fancy. Ask your printer to show you our sample books, or write to us for them.

Made in White, Azure and Buff. Envelopes to match all lines.

### THE ROLLAND PAPER COMPANY LIMITED

GENERAL OFFICES - MONTREAL, P.Q.  
MILLS AT ST. JEROME AND MONT ROLLAND, P.Q.

## GENUINE "KRAFT" PAPERS

*Made in Canada*

### THE NEW BRUNSWICK PULP & PAPER CO.

Springfield Mills, Millerton, N.B. Limited

Ontario Representative - E. H. WILKINSON  
Telephone Building, 82 Adelaide Street West - TORONTO

## PANZL'S PATENTED LINING COMPOSITION

IS THE SAFEST AND BEST MATERIAL FOR

**LINING OF SULPHITE PULP DIGESTERS**

AND ACID RECLAIMING TANKS

**PANZL LININGS ARE SAFEST AND MOST DURABLE**

They are really acid-proof and practically indestructible.

All Digesters lined with Panzl's patented composition, now as tight and in as good condition after years of continuous use as they ever were, no leaks and no repairs.

Panzl Linings can be made considerably thinner than the other linings, thus increasing the capacity of the digesters

The composition and the system of constructing of Panzl Linings are patented in all countries where wood pulp is being manufactured by the sulphite process. The PANZL U.S. Patents have been adjudicated to be valid in law and wholly independent of all prior patents relating to linings of digesters.

For information and estimates, address:—

**PANZL DIGESTER LINING COMPANY**

505 Washington Ave., Muskegon, Mich.



## The Riordon Paper Company, Limited

Fibre, Paper, Lumber.

MONTREAL - CANADA

News Paper, Hanging Paper, Wrapping Paper, Building Paper,  
Celebrated "Impervious" Spruce Sheathing and Sulphite Fibre for all  
kinds of Paper.

## Barber Paper and Coating Mills Ltd.

GEORGETOWN, ONT.



Manufacturers of  
SURFACE COATED BOOK and LITHOGRAPHIC  
PAPERS, COATED CARDBOARD and COATED  
BOXBOARDS of every description.

## "Chalk White" Coated Book Paper.

The best and whitest coated paper sold.

**ALL REGULAR SIZES AND WEIGHTS IN STOCK.**

Our Art Litho Cover Paper is stocked in four tints,  
2 sizes. 20 x 25 and 21½ x 28½. Samples gladly sent.

MONTREAL  
TORONTO

**CANADA PAPER CO.**  
LIMITED

WINDSOR  
MILLS, P.O.

# DIRECTORY

of

## Civil and Chemical Engineers

### T. PRINGLE & SON, Limited

Engineers and Architects

Plans and Specifications for Pulp and Paper Mills. Power Plants and other Industrial Works.  
**Coristine Bldg.**      **Continental Life Bldg.**  
**Montreal.**      **Toronto.**  
 Bell Tel.: M. 3890.      Tel.: M. 5917.

### R. S. LEA, and H. S. FERGUSON, ENGINEERS

Pulp, Paper and Chemical Fibre Mills.  
 Water Power Development and Trans-  
 mission. Steam Power Plants.  
 Telephone Long Distance U.D. 75L.  
 820 New Birks Bldg., MONTREAL

### Arthur D. Little Inc.

— LABORATORY OF —  
 ENGINEERING CHEMISTRY  
**93 BROAD ST., BOSTON, - MASS.**  
 Our staff includes experts in Papermaking Chemistry  
 —Sulphite Mill Practice—Fuel Engineering.

### GEORGE F. HARDY, M. AM. SOC., M. E. M. CAN. SOC. C. E.

Consulting Engineer.

Paper, Pulp and Fibre Mills, Examination of  
 Mill Properties, Water Power Developments.  
**Mutual Reserve Building, - 309 Broadway,  
 NEW YORK.**

CHARLES E. EATON,      JAMES P. BROWNELL,  
 M. Am. Soc., M. E.      C. F.

### EATON & BROWNELL, Consulting Engineers and Architects.

Paper, Pulp and Fiber Mills, Water, Steam and  
 Electric Power Development, Examination of  
 Properties, Consultation Reports.  
**SMITH BLDG.      WATERTOWN, N. Y.**

ENGINEERS SHOULD WRITE  
 THE PUBLISHERS FOR RATE  
 OF CARDS ON THIS PAGE.

### T. LINSEY CROSSLEY

*Engineering Chemist*  
 PULP AND PAPER  
 TECHNOLOGY

318 Lagachetiere St., W., Montreal

### R. O. & W. G. SWEZEY

— Civil and —  
 Forest Engineers

Limit cruising, surveys, water storage,  
 power, lumbering contracts.

METROPOLITAN BLDG., QUEBEC

ASSOCIATED WITH

### HERBERT S. KIMBALL

M. AM. SOC. C. E.

*Mill Architect and Engineer*

111 Devonshire St., Boston

### FOREST ENGINEERS

FOREST SURVEYS      LOGGING MAPS  
 WATER POWER      TIMBER ESTIMATES      WATER STORAGE

CLARK, LYFORD & STERLING  
 1331 Real Estate Trust Bldg., Philadelphia  
 CLARK & LYFORD      LYFORD, CLARK & LYFORD  
 403 Crown Bldg.      26 Board of Trade Bldg.  
 Vancouver.      Montreal.

**PULP  
PAPER  
POWER** JOSEPH H. WALLACE & CO.  
INDUSTRIAL ENGINEERS.  
TEMPLE COURT BLDG. NEW YORK.  
SALISBURY HOUSE, LONDON, E.C.  
CABLES, TRIPLEX, N. Y., TRIPLEXIS, LONDON.

**C. B. PRIDE**  
MILL ARCHITECT & ENGINEER  
PAPER, FIBER, AND PULP MILLS,  
— WATER & STEAM POWER DEVELOPMENT  
25 YEARS SUCCESSFUL OPERATIONS  
SPOKANE, WASH OFFICES APPLETON, WIS.

**J. A. De CEW** M.A. INST. CHEM. ENG. *Chemical Engineer*  
A.M. CAN. SOC. C.E.  
Paper Mill Analysis Pulp Testing Investigations  
Sulphite Fibre, Soda Fibre Reports  
CANADIAN EXPRESS BUILDING - - - MONTREAL

Power, Lighting, Heating, Ventilating and Drying.—Complete New Plants, Improvement of Old Plants;  
Plans, Specifications, Contracts, Estimates, Tests, Appraisals, Inspections and Reports.—Pulp, Paper,  
Box Board and Coating Mills.

Lowest **H. B. PRATHER,** Guaranteed  
Possible *CONSULTING ENGINEER,* Results.  
Operating Cost. ROCKFELLER BLDG., CLEVELAND, O.

**HUGH R. BLETHEN**  
21 PARK ROW, - - - NEW YORK, N.Y.  
Traveling Cranes - Overhead Tramways - Trolleys and Chain  
Hoists for Paper and Pulp Mills - Power Houses.

**Stebbins Engineering & Mfg. Co.**  
WATERTOWN, N.Y.  
MANUFACTURERS OF  
STEBBINS' ACID SYSTEMS, SULPHUR BURNER  
DIGESTER LININGS, RECLAIMERS, ETC.  
Engineering Department Plans, Estimates and Specifications for Paper,  
under Pulp and Fibre Mills,  
Mr. T. L. TOMLINES Water Power and Hydro-Electric Developments

# LEUNIG PAPER SCALES

Showing correctly at a glance, by weighing a single sheet, the weight of a ream of Paper of any size, containing either 480, 500, or 516 sheets.

Can also be made to indicate in addition to the English weight, the weight in Kilogrammes.

Illustrated Price List on Application.

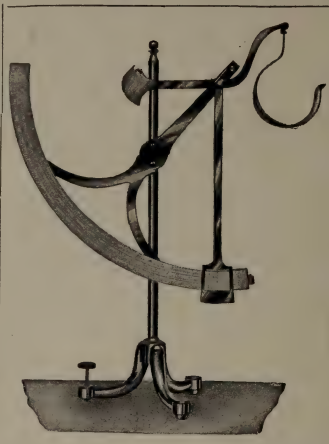

$\frac{1}{2}$  to 80 lbs.

**Price,**  
**Ten Dollars**  
F.O.B., London

$\frac{1}{2}$  to 120 lbs.

**Price,**  
**Fourteen Dollars**  
F.O.B., London

Illustrated Price  
List on Application.

**Alfred H. Mardon** 150 Shaftesbury Ave. **London, Eng.**

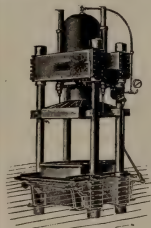

# PULP PRESSES

AND ACCESSORIES

CANADIAN BOOMER & BOSCHERT PRESS  
COMPANY, LIMITED

18 TANSLEY STREET, MONTREAL

"LACHUTE FELTS" Bell Tel. No. 23

# The Hamelin & Ayers Co., Limited

LACHUTE MILLS, P.Q.

MANUFACTURERS OF EVERY DESCRIPTION OF

# FELTS FOR PAPER AND PULP MILLS

"The Best are the Cheapest."

# Every Papermill



*must have a daylight lamp*

**“HELIA”**

*is a real daylight lamp*

Strong, cheap and economical. By the aid of “Helia,” every graduation of color can be exactly determined with the same precision as in daylight.

---

*Sole Agency in Canada and U.S.*  
**GUSTAF FORNSTEDT**  
*THREE RIVERS - - - QUE*

## The Union Sulphur Company

Producers of the Highest Grade Brimstone on the Market

---

Absolutely free from Arsenic, Selenium or Tellurium

---

**The Largest Sulphur Mine in the World**

**CALCASIEU PARISH, - LOUISIANA**

**Main Offices : Whitehall Bldg., 17 Battery Place  
NEW YORK**



**WE GUARANTEE OUR SIZINGS TO BE ABSOLUTELY CLEAN  
OUR VERA PAPER SIZE**

is purest, strongest and highest free rosin size made. We can furnish you with an ideal rosin size and patented apparatus to use same.

**OUR VERA MILL SIZE**

is the best soluble paper makers' rosin size made. Ready to use in cold or warm water in the ordinary way without apparatus. Gives better satisfaction and is more economical than mill made size.

Our sizings are cleaned by our new patented process and we guarantee this size to be absolutely clean, without the least speck of impurity in the same, preventing thereby black specks in the paper. **We are shipping our size in barrels or tank-cars.**

**VERA CHEMICAL COMPANY**

Main Office and Western Factory  
NORTH MILWAUKEE, WIS.

Eastern Factory  
STONEHAM, MASS.

**J. R. Walker & Co.** Importers and Packers of **GRADED RAGS, PAPER STOCK  
ROPE BAGGING, ETC.**

WAREHOUSE, 35 COMMON ST., MONTREAL.

Also Manufacturers of Roofing and Building Papers. Leatherboard and Friction Board

Mills at Sault au Recollet, P.Q.

**ATTERBURY BROTHERS, Incorporated.**

*Importers and Exporters.*

**Wood Pulp,** FOREIGN AND DOMESTIC **Rags AND Paper Stock**

Potter Building, 145 Nassau Street, New York City.

Cable address "AFFECTIVE," New York.

**CHURCHILL & SIM**

29 CLEMENTS LANE, LONDON, E.C.

And at Manchester

**WOOD PULP AGENTS**

Telegraphic Address:—  
"CHURCHILL, LONDON."

A.B.C. CODE  
5th Edition

## ACCURATE RECORDS

of pressure or vacuum can be obtained only from accurate Recording Gauges—naturally. And accurate records are the only kind that are of any value—that's certain. That's why

### "COLUMBIA" Recording Gauges

are so popular and becoming more so every day. Because they are accurate and *stay* accurate. Because they are reliable, durable and superior in mechanical detail to all others. Because their charts are uniformly graduated, have wide effective working range and have the *right and day border*.

Still we don't ask you to believe this. Prove it for yourself. Every "Columbia" that leaves our shop is fully *guaranteed* and shipped on *approval*, which means should it not come up to your expectations in every respect, send it back—there is no expense to you.

Send for Pamphlet Q 105 without delay.

The Schaeffer & Budenberg Mfg. Co.  
Chicago BROOKLYN, N.Y. Pittsburgh

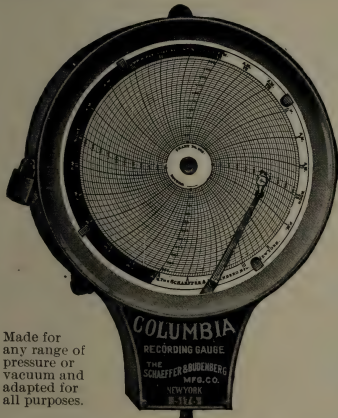

Made for any range of pressure or vacuum and adapted for all purposes.

## GEWERKSCHAFT SACHTLEBEN

Homberg-Niederrhein, GERMANY

Largest Makers  
of all Celluloses

# BLANC FIXE

Three  
Varieties

Bright, Matt or Dull  
Photographic

## THE STANCLIFFE ESTATES CO. LTD.

DARLEY DALE - - - ENGLAND

J. H. DAWSON, Man. Dir.

**BEST ENGLISH PULP STONES** from our celebrated Darley Dale Quarries  
as supplied to the Canadian Market  
Prices and particulars on application

Liebers Code Used

Telegraphic Address, "Stancliffe," Twodales, England

# If Your Grinder Valves Leak Stop 'em!



There is no one thing that causes more annoyance around the Pulp mill than leaky grinder valves.

## THE WATEROUS GRINDER VALVE

overcomes that.

It is designed to be a tight valve, and it can be kept so.

Of the piston type the valve body is exceptionally strong, is lined with seamless brass tubing, has rods and pistons of bronze and is built and tested to stand a pressure of 100 lbs. per square inch.

When repairs are needed, all that is necessary is to replace the two cup leather packings—done in a few minutes—and the valve is as good and as tight as new.

THE WATEROUS GRINDER VALVE uses single or double pressure as desired—one lever operates both. The Waterous Valve fits any cylinder. It can be placed in any of four positions to be most convenient for the operator.

Let us fit one on your grinder and show  
you what we mean by a "tight valve."

**The Waterous Engine Works Co., Ltd.**  
BRANTFORD, CANADA

**Geo. Christie Ltd. - - - Glasgow Scotland**

**FOURDRINIER MACHINE WIRES**

**Unequaled for Strength, Smoothness and Long Life**

**CYLINDER COVERS**

**Canadian Agent :**

**J. A. Taylor, 22 St. Francois Xavier St., Montreal**

**CANADIAN TALC FILLER**

**GEO. H. GILLESPIE COMPANY**

**MADOC - - - ONTARIO**

*The only Manufacturers of Paper Filler in Canada.*

Our Filler is used in Canada, United States, England, Germany, Austria, Holland, Russia and Scandinavia.

**AMBURSEN HYDRAULIC CONSTRUCTION CO.,**

**OF CANADA, LIMITED**

**822 New Birks Building - MONTREAL**

*Associated with the Ambursen Hydraulic Construction Co., of Boston, Mass.*

**Concrete Steel Dam**

OF THE

**MISSISQUOI PULP CO.,**

**Sheldon, Springs, Vt:**



Mid-channel, height 40 feet.  
Total length 270 feet (only 180 feet shows in the picture, the remainder being concealed at the left.)

Dam specially designed to withstand heavy ice gorges.

Factors of safety, are calculated for a 12-foot flood.

**IF YOU HAVE A DAM TO BUILD, WRITE US NOW.**

Every Grade of Waste for  
Paper Making.

# R. HOUGH

LONDON, England.

Agent for Canada and U.S.,

**THE J. CHRISTIE CO.**

5 King St. West, TORONTO, Canada.

STEAM PUMPS  
CONDENSERS  
VACUUM PUMPS  
TRIPLEX POWER PUMPS  
CENTRIFUGAL PUMPS

The Smart-Turner  
Machine Co., Limited

HAMILTON

CANADA

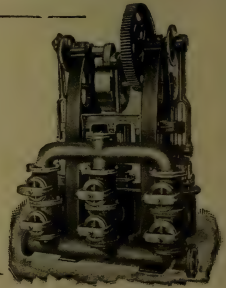

**NORTHERN  
CRANES**

and Hoists  
Overhead  
Track and  
Trolley  
Systems

Northern Crane Works Ltd.  
WALKERVILLE - ONTARIO

# WINN & HOLLAND, Limited

MONTREAL

PULP AND PAPER CHEMICALS.

Sole Agents for:

**BRUNNER, MOND & CO'S.**

SODA ASH,

BLEACHING POWDER,

SAL SODA,

CAUSTIC SODA, &c.



# PULP AND PAPER MAGAZINE OF CANADA

VOL. 10 TORONTO, OCTOBER, 1912 No. 10

## PRINCIPAL CONTENTS

Pulpwood Export Question Again  
Prevention of Accidents  
Congress of Applied Chemistry  
The Canadian Forestry Convention  
Soda Process for Manufacturing  
Cellulose  
Consumption of Heat in Indirect  
Sulphite Digesting Process  
Development of Chemical Wood-Pulp  
Industry in Sweden  
Jack Pine and Hemlock for Mechan-  
ical Pulp  
Effect of Fire in a Reinforced Con-  
crete Paper Mill

# THE JONASSEN PULP REFINER

For the Reclaiming of Ground  
Wood and Sulphite Screenings

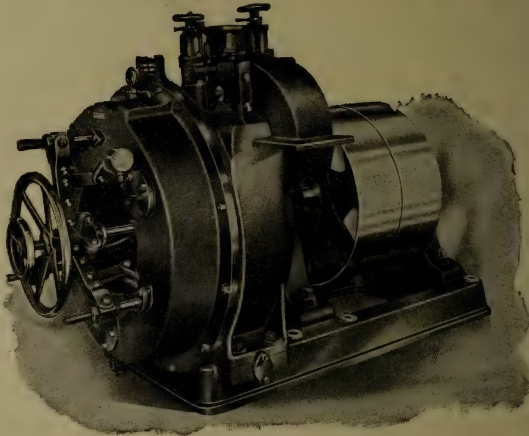

With this Refiner you save all your Ground Wood and Sulphite Tailings or Screenings, which now go to waste.

Capacity of Machine: From 8 to 10 tons of Screenings a day.

Power required to operate same: 20 horse power.

Write us for prices and further information.

## Rice Barton and Fales Machine and Iron Co.

WORCESTER, MASSACHUSETTS, U.S.A.



**Decrease Labor and  
Power Costs,  
Increase Plant Capacity.**

by installing

## **JEFFREY PULP LAP SHREDDERS**

They prepare Dry, Wet or Frozen Stock  
for Mixing Engines.

### **GUARANTEED CAPACITY:**

10 tons (dry weight) per hour when  
reducing wet, dry or pressed pulp.

6 tons (dry weight) per hour when  
reducing frozen pulp.

*Write for Complete Information,  
Prices, etc.*

## **JEFFREY MANUFACTURING COMPANY**

*Canadian Main Office and Works, Montreal*

*Winnipeg Representatives - - N. J. Dinnen & Co.*

*E. J. WELCH, President and Managing Director  
HENRY W. S. DOWNS, Superintendent*

*EMMONS CROCKER, Vice-President  
A. S. MORSE, Secretary and Treasurer*

# **SCREEN PLATES**



**The "Union" Bronze (best phosphorized cast metal) Plates for Sulphite Mills. The Standard Rolled Brass Plates. The "Union" Cast Metal Suction Plates.**

We carry a large stock of blanks of the various sizes in both metals and can fill all orders promptly.

Old plates reclosed and recut by our process are practically as good as new and give better results than by any other process

## **Union Screen Plate Co. of Canada, Limited**

**FACTORY: LENNOXVILLE, QUEBEC.**

**OFFICES: Lennoxville, Quebec, and Fitchburg, Massachusetts, U. S. A.**

— THE BEST —  
**JORDON ENGINE**  
 IS BUILT BY THE

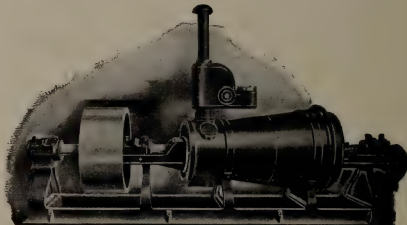

**APPLETON MACHINE CO.**  
 APPLETON, WIS.

SEND FOR PARTICULARS

**DODGE**

**Transmission** —\*

—\* **Machinery**

— **High Grade Only** —

**Shafting, Hangers, Pulleys,  
 Friction Clutch Pulleys.**

**DODGE MANUFACTURING CO.**

640 ST. PAUL ST.  
 HAYMARKET SQUARE

**MONTREAL** LIMITED

Telegrams :  
"CALENDER, BURY"

Telephone :  
NUMBER 340

# Bentley & Jackson,

Limited

PAPER MAKERS'

.. ENGINEERS ..

BURY, - - ENGLAND

## *SPECIALITIES.*

MODERN HIGH SPEED NEWS PAPER  
MAKING MACHINES

SINGLE CYLINDER PAPER MAKING  
MACHINES

*The NEW "MARSHALL" PATENT REFINING ENGINE,*  
with separate adjustment to cones and discs, and our patent  
Ball Thrust Bearing

**HELIN'S PATENT BEATER ROLLS AND BEDPLATES**

**APPLY FOR PRICES**



# Bertrams Limited

SCIENNES

Edinburgh

- -

Scotland

---

---

*Fast Running Paper Making  
Machines*

*Single Cylinder Machines*

*Bleaching, Washing and Beating  
Engines*

*Improved Refining Engine*

*Motor Driven Centrifugal Pumps*

*Highest Quality Hard Metal  
Screen Plates*

---

---

Full particulars from

**CHAMBERS & SIMPSON**

152 Bay St. - Toronto, Ont.

# New Centrifugal Screen

WITH HORIZONTAL SHAFT

PATENTED IN ALL PRINCIPAL COUNTRIES

**Smallest Power  
Highest Output**

**Direct Belt Drive  
Noiseless Working**

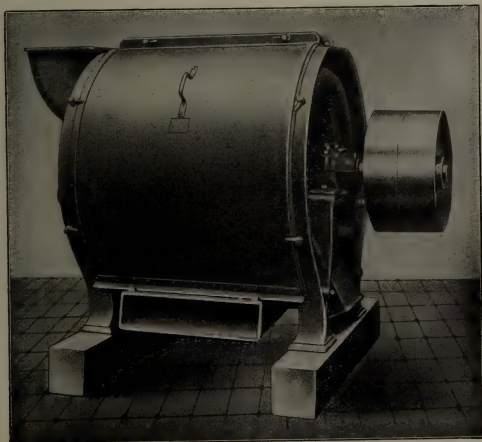

Equally well adapted for GROUND WOOD and SULPHITE

*I have now sold over 800 of these Screens*

FURTHER DETAILS, PROSPECTUS AND PRICES ON APPLICATION

**Complete Machinery for Wood Pulp, Paper and  
Sulphite Mills**

---

---

## J. M. VOITH

ENGINEERING WORKS AND FOUNDRIES

HEIDENHEIM ON BRENZ, WURTEMBERG, GERMANY

Branch Office for Canada and U.S.A., 1008 Fifth Ave. Bldg., New York

Representative: H. F. STORRER, C.E.

J. MARX & CO.

--

LONDON, E. C., ENGLAND

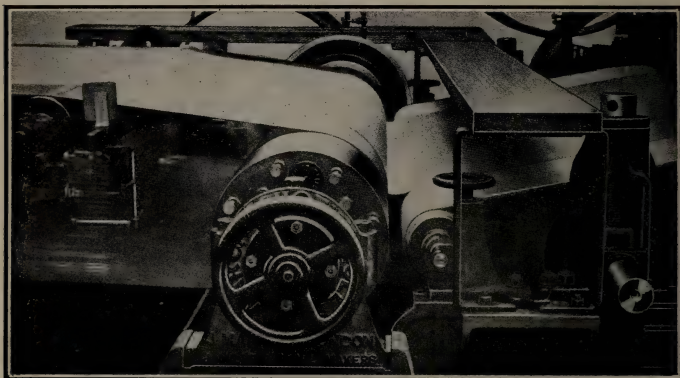

MARGALT SUCTION ROLL AT WORK

SPECIALTIES BASALT LAVA STONE BEATER ROLLS, DOUBLE BEATERS, STONE WET PRESS ROLLS, BASALT LAVA PULP REFINERS FOR SCREENINGS

Canadian Representative

Judson A. DeCew

Canadian Express Building

Montreal

*The*

# Harmon Incline Screening System

Will give greatest capacity.

Will give cleaner stock.

Will save power.

Will save labor.

Does not require use of Rakers.

Write us for full descriptive Catalogue and testimonials from the best mills in the country.

## HARMON MACHINE COMPANY

WATERTOWN, N. Y., U. S. A.

OTTO WANDEL  
President

HERBERT H. MILLER  
Treasurer

# Wandel Screen Manufacturing Co.

WALPOLE, MASS., U.S.A.

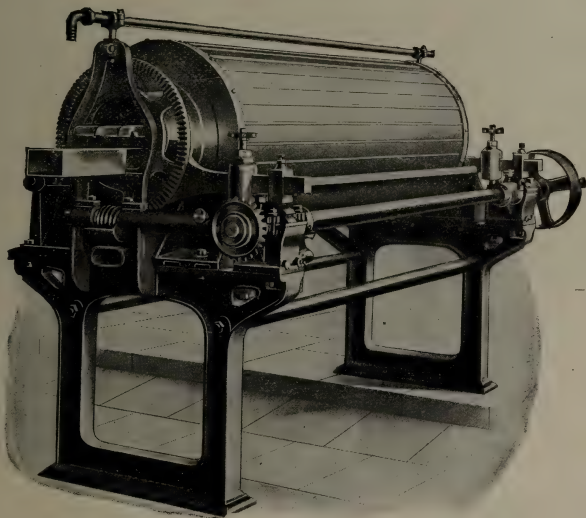

MANUFACTURERS OF THE

Quick Delivery.  
Write for Catalogue  
and list of users.  
We have no author-  
ized Agents in  
Canada.

# WANDEL ROTARY SCREEN

Over 200 Wandel  
Screens have  
been built and sold  
by us in the States  
within two years.

## SUPERIOR CONSTRUCTION

---

**THE SANDY HILL IRON AND BRASS WORKS, HUDSON FALLS, N.Y.**

---

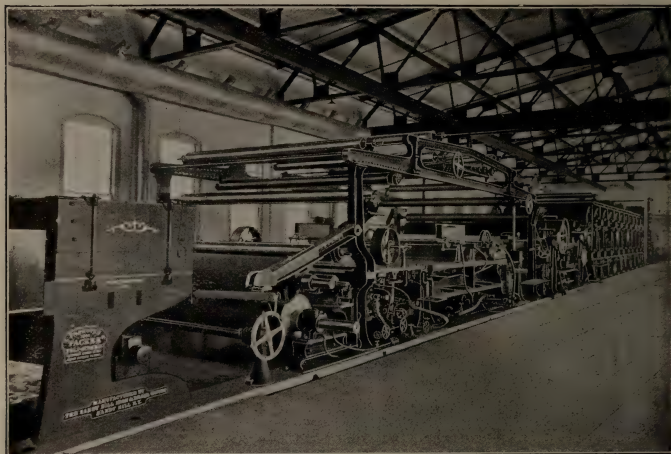

130" HARPER FOURDRINIER PAPER MACHINE

---

## A GOOD JORDAN ENGINE

BUILT IN 3 SIZES.



## THE BLACK-CLAWSON CO.

HAMILTON, OHIO, U.S.A

Builders of **PAPER MAKING MACHINES** and machinery for Paper and Pulp Mills. Our machines are completely erected in shop on cast iron levelling plates and carefully inspected before shipment.

*Write for Catalogue.*



# The "WESTBYE" SCREEN

*Its Novel Features are of Importance to You*

Built for Belt or Motor Drive

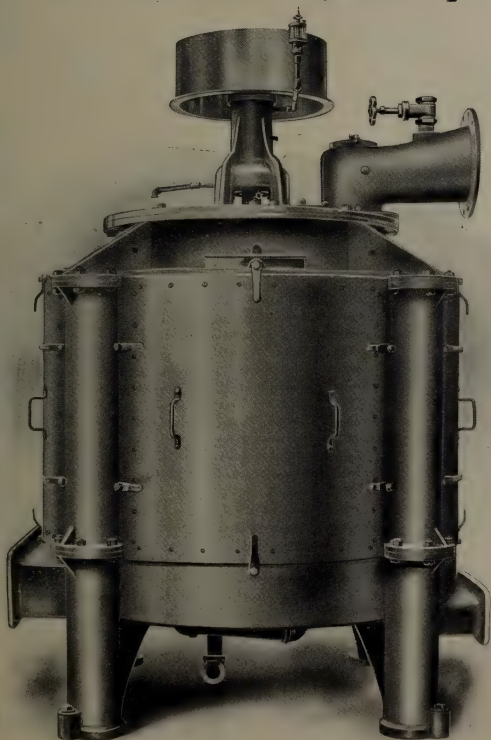

Investigate and learn something NEW in the screen line

*For Details and Prices  
apply to*

**P. P. WESTBYE**  
PETERBOROUGH,  
CANADA



## GARLAND PULP LOG Storage and Conveying Systems

Inventors of the CABLE CONVEYER

*We have equipped 50 of the best American PULP and PAPER MILLS with CONVEYERS, LOG CUT OFF SAWS, SLASHERS, SPLITTERS, BAND MILLS and SPECIAL MACHINES*

*Send us your plans or ask for Representative to call on you*

### THE M. GARLAND COMPANY

Manufacturers of CONVEYING, SAW MILL  
and WOOD DESTRUCTIVE MACHINERY

BAY CITY - - - MICHIGAN, U.S.A.

# Have You Heard the Facts About The Beloit Machines?

---

---

One Fourdrinier built for 500 feet has run 615 feet, and averages 550 feet and makes 72,000 lbs. of print in 23 hours, 110 inch trim.

Another, built for 350 feet, for manillas, is running 490 feet every day on print.

Two others, built for 250 feet on book, are now speeded up to 340 feet on book.

A cylinder machine built for 40 tons of strawboard has made 89 tons in 23 hours, and averages 76 tons per day, dryers are 116 inch face.

---

---

## Beloit Iron Works

BELOIT, WIS., U.S.A.

# DILLON MACHINE CO

BUILDERS OF

## PAPER MILL MACHINERY

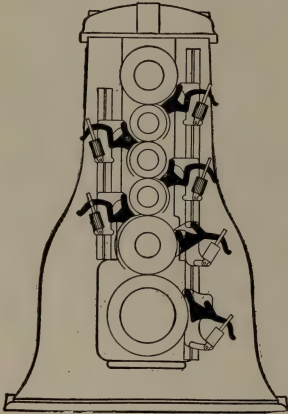

Beating Engines  
 Washing Engines  
 Jordan's Three Sizes—  
 Single, Double & Triple  
 Stuff Pumps, with  
 Dillon Patent Valve  
 Seating

Brannan Patent Paper  
 Folders

Horizontal and Vertical  
 Stuff Chests

Single and Double Paper  
 Cutters

Backstands

Plates, Knives and Bars

DILLON  
 PATENT  
 DOCTORS  
 AND FEEDS  
 MADE IN  
 CANADA  
 BY THE  
 SHERBROOKE  
 IRON WORKS,  
 SHERBROOKE, P.Q.

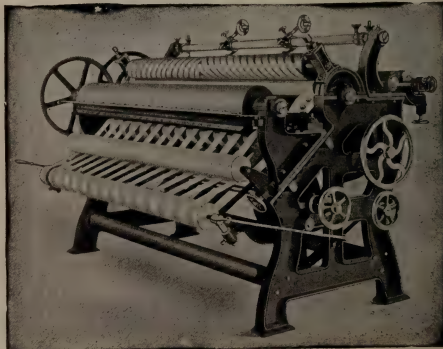

LAWRENCE, MASS., U.S.A.

---

---

# THE MOORE & WHITE CO.

ENGINEERS, FOUNDERS, MACHINISTS

## PAPER MACHINE BUILDERS

Inquiries solicited and given prompt and careful attention.

Specifications and estimates for paper and pulp machinery on either new or repair work cheerfully given

Quality guaranteed strictly high-grade



Office and Works, North Philadelphia Station, P. R. R.  
Philadelphia, U. S. A.

PAPER MACHINES FOR ALL GRADES OF PAPER

ALL GRADES OF BOX BOARDS

ROOFING, FELT AND BUILDING PAPERS

---

SATURATING AND ASPHALT COATING MACHINERY

“M & W” FRICTION CLUTCHES

“M & W” VARIABLE SPEED CHANGES

PRINTING MACHINES

FOR FLOOR CLOTH AND LINOLEUM

Bulletins and information on any of the above subjects sent on request.

---

---



# HOLYOKE MACHINE COMPANY

## HOLYOKE, MASS., U.S.A.

MANUFACTURERS OF

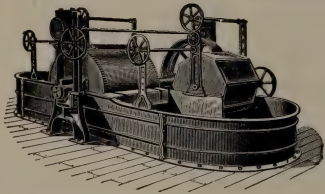

Washing and Beating Engines with  
Patent Double Hoist and Tubs of either  
wood or iron.

Hydraulic Pumps and Presses.

Rag Cutters and Rag Dusters.

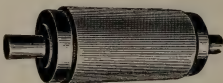

Cotton and Paper Rolls with Patent Fastenings.

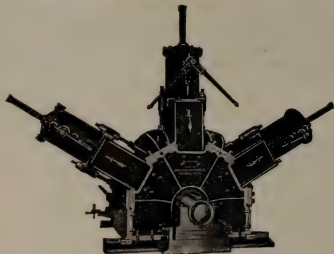

Patent Improved Wood Pulp Grinder.

Elevators, Rotary Fire Pumps and  
Friction Gearing.

Gears Accurately Spaced and Planed.

Shafting, Pulleys and Mill Work.

Machinery for Wood Pulp and  
Paper Mills.

Vertical and Horizontal Water  
Wheels with Flumes and  
all connections.

Wood Barkers, Wood Chippers  
and Wet Machines.

## Newest Designs

AND

## Highest Efficiency

Calenders. All kinds of Super  
Calenders, Friction Calenders  
and Platers.

Chilled Iron Rolls.

Special Machinery

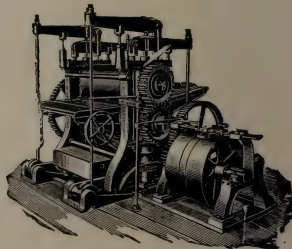

**Description and Estimates Furnished; also Gear List  
and Catalogs sent on application.**

# Pulp Mill Machinery

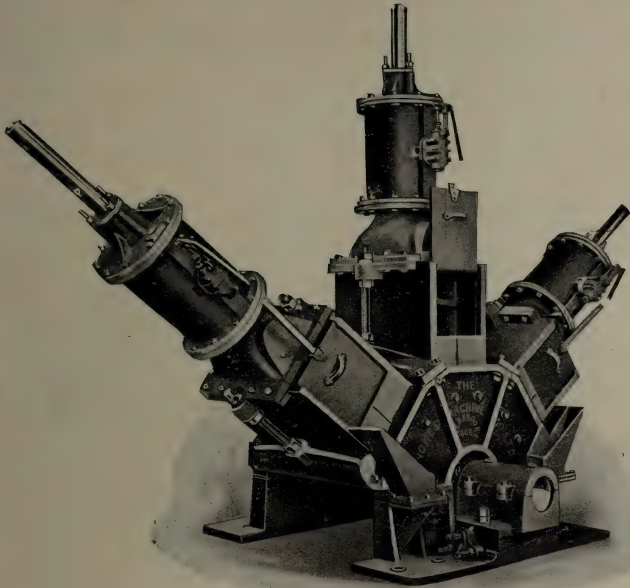

Our Grinders combine the latest and best features in Wood Pulp Grinder construction and have many recent improvements.

We also manufacture Wet Machines, Screens, Presses, Barkers, Complete Wood Room Equipment and Turbine Water Wheels.

LET US QUOTE ON YOUR REQUIREMENTS.

## The Jenckes Machine Co., Limited

General Offices: SHERBROOKE, QUE.

Factories: Sherbrooke, Que., St. Catharines, Ont.

Sales Offices: SHERBROOKE, MONTREAL, ST. CATHARINES, COBALT  
SOUTH PORCUPINE, VANCOUVER, NELSON, B.C.

# James Bertram & Son, LIMITED.

LEITH WALK - EDINBURGH

---

## “LEITH WALK”

PATENT HALF DRUM STRAINER

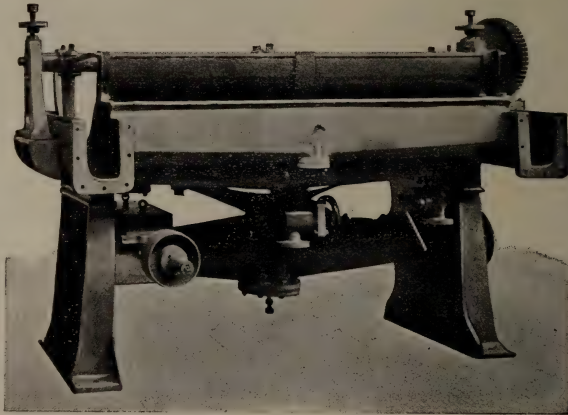

### *ADVANTAGES :*

Enclosed Self Lubricating Driving Gear  
Stroke can be altered whilst Strainer is at work  
Plates can be cleaned in a few minutes without removal  
Noise'ess in action, with small cost in upkeep  
Great capacity with upward flow of Pulp

---

Telegrams : “Bertram, Leith”

# PNEUMATIC

## *Save-Alls, Pulp Thickeners and Filters*

Remember that we make Special Pneumatic Machinery,  
not only for saving waste from white water but for  
thickening pulp and

*for filtering river water*

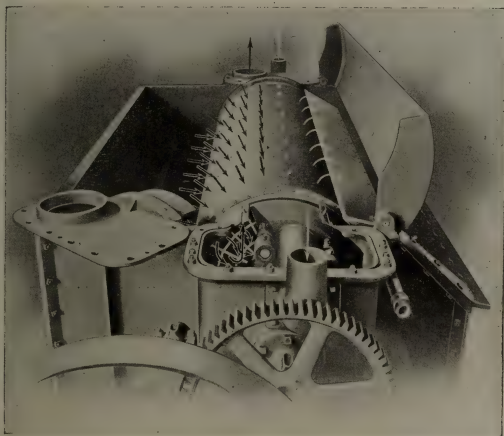

Pneumatic Action of the Save-All

The same pneumatic principle which has made our Pneumatic Save-alls and Pulp thickeners so successful has proved wonderfully effective in our Pneumatic Filter for river water. In this machine we employ an exceedingly fine cylinder-mold facing, through which several million gallons of water per 24 hours can be filtered clean. The clean filtering is due to the minute "mesh" of the covering and the continuous cleansing with air-blast and water-jet; the enormous capacity is due to the pneumatic action; the long life of this Filter is due to the absence of all mechanical wear upon the cylinder.

This machine is filtering clean even in cases where the river is exceptionally dirty because of saw mills located upstream.

*Send for particulars*

---



---

**Sherbrooke Machinery Company**  
LIMITED

SHERBROOKE

QUEBEC

**RENOLD PATENT SILENT CHAINS**



(Drive Stationary)

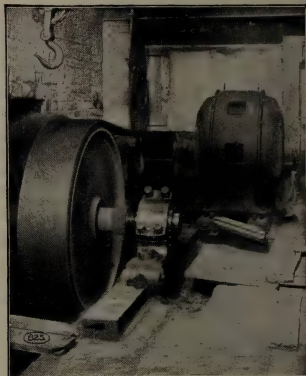

(Chain Speed 1,180 f. p. m.)

150 h.p. Line Shaft Drive

**NOT AFFECTED BY HEAT, VAPOR OR MOISTURE**

We have installed, and in some cases completely equipped, the largest and foremost Pulp and Paper Mills in Canada with the Renold Chains

**JONES & GLASSCO**

ENGINEERS

Registered

SOLE CANADIAN AGENTS  
**MONTREAL**

**Lawrence Machine Co.**

LAURENCE

MASS.

— MANUFACTURERS OF —

**Lawrence Centrifugal Pumps**

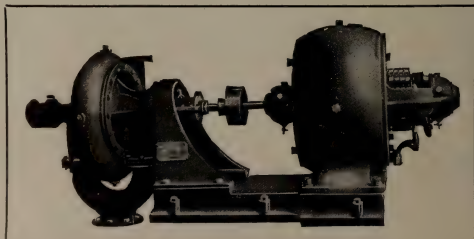

LET US FIGURE ON YOUR REQUIREMENTS



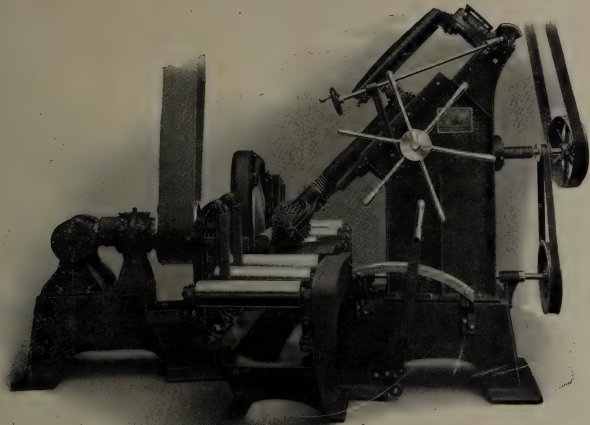

## Are You Aware of the Fact?

That the Robert & Libert Green Bay  
Barker covers every pulp producing  
country in the world.

### Green Bay Barker Co.

GREEN BAY, WIS.

KUUSANKOSRI, FINLAND.



Interior of the  
Machine  
Room of  
Messrs. Ed-  
ward Lloyd,  
Ltd.

Sittingbourne,  
England,  
containing the  
last two  
machines  
supplied to  
this Company  
by Chas.  
Walmsley &  
Co., Ltd.



These "Walmsley" Fast News Machines are 175 inches wide, and are making paper at over 600 feet per minute, with an output of 500 tons news print weekly. The machines are equipped with the Lloyd and Hutchison Patent Drive. This patent device is controlled by Walmsley & Co., Ltd., and dispenses entirely with Friction Clutches and Gear Wheels.

# Charles Walmsley & Co. Ltd.

PAPER MAKERS' ENGINEERS

BURY - England

Head Offices,  
ATLAS WORKS  
Branch,  
WOOD STREET

*Codes, WESTERN UNION, A.B.C. 5TH EDITION,  
MCNEILL'S 1908*

*Telegrams, "PUMPS, BURY."*

*Telephone, BURY 499*

## SPECIALTIES—

Complete Paper Mill Plants  
Variable Speed Enclosed Steam Engines  
Cone Beaters for News Stock  
Slitting and Re-Reeling Machines  
Beating and Refining Engines  
Super Calenders  
Buffing Machines, etc., etc.

## FOREIGN REPRESENTATIVES

Norway, Sweden and Finland :  
N. A. EIE - Christiania  
Austria, Hungary :  
F. SCHOFFEL, Engineer, Vienne  
CANADA :  
C. H. JOHNSON & SONS  
LIMITED  
ST. HENRY, MONTREAL

# Wilson-Paterson Co'y



127 BOARD OF TRADE BLDG., MONTREAL.

Agents for the United Alkali Co. of England

## **OFFER TO THE TRADE:**

Caustic Soda 60° to 78° Soda Ash, Caustic Potash, Sal Soda, Silicate of Soda, China Clay, Rosin size and a full line of Rosins, direct shipment from the south.

**Contracts made for regular supplies.**

# PARSONS TRADING COMPANY

*Exporters of Paper to all Parts of the World*

WHITEHALL BLDG., 17 BATTERY PLACE, NEW YORK

BRANCH OFFICES AT

LONDON

SYDNEY

MELBOURNE

WELLINGTON

CAPE TOWN

BOMBAY

HAVANA

MEXICO, D.F.

BUENOS AIRES

**CORRESPONDENCE WITH MILLS SOLICITED**

# THE CARTHAGE CHIPPER

WILL INCREASE YOUR CHIPS. WILL  
DECREASE YOUR SAWDUST. By virtue  
of its Design and its Patent Feed Spout it takes a  
MINIMUM AMOUNT OF POWER.

---

Ask Anglo- Newfoundland Development Co.  
Ask Laurentide Pulp and Paper Company.  
Ask The Riordon Paper Company, Limited.

---

OR WRITE

**CARTHAGE MACHINE CO.**  
**CARTHAGE, N.Y.**



# Pulp and Paper Magazine of Canada

*A Magazine devoted to the interests of Canadian Pulp  
and Paper Manufacturers and the Paper Trade.*

SUBSCRIPTION PRICE; \$2.00 a year. Single Copies, 20 cents.

OFFICE OF PUBLICATION : 226-7 Confederation Life Building, Toronto, Canada  
MONTREAL OFFICE : 34.B. Board of Trade Building

---

---

## *Pulpwood Export Question Again*

---

The campaign waged two or three years ago in favor of the Dominion Government placing an export duty or a complete embargo on the export of pulpwood out of Canada is being renewed under more favorable auspices. It will be remembered that E. N. Lewis, M.P., and others took the matter up in the House and that his arguments received wide support, not only from pulp and paper manufacturers, but from those who believe in the conservation of the nation's natural resources and including some of the most pronounced Free Trade newspapers.

The idea of restriction of the output to foreign manufacturers of Canadian pulpwood has evidently been growing in favor for years past as witness legislation to that end in Ontario, Quebec, New Brunswick, and British Columbia, but the Provinces, of course, have only power over wood from Crown lands, that from privately owned domains being subject only to the will of their owners. The Federal Government has no privilege to interfere with Provincial regulations, but it has power to impose a general tax on export or to prohibit exportation altogether.

This is what the Laurier Government was asked to do, and is what is now being asked again of the Borden Government, which is supposed to be more favorable to protectionist and conservation arguments.

If the proposition to convert Canada's labor and raw material into Canadian manufactured products be a good one, which undoubtedly is the case, it surely is a particularly good proposition in the case of the pulp and paper industry. Last year nearly 848,000 cords of pulpwood were shipped from Canada into the United States, the average value being \$6.29 per cord. If this quantity had been converted into mechanical or chemical pulp in the country of its origin, the value realized would have been \$15.55, or \$38.25 respectively. If finished still further into the form of paper, the value would have been correspondingly very greatly increased. When the matter was set forth in this light to the late Government, the weight of the argument was admitted, but its advisers presumably were swayed still more by the fact that in the Province of Quebec, from whence vast quantities of pulpwood are shipped to the United



States, large numbers of French-Canadian "habitants" rely largely for their livelihood upon the cutting of pulpwood for export.

It is easy to let off rhetorical fireworks over such a matter as the depriving of a community of its means of livelihood. But a dampening effect will immediately be exercised if we will just glance for a moment at the contrast presented by two typical French-Canadian districts. One is Batiscan, which is a centre from which go large quantities of pulpwood for use by the International Paper Co. in the States. The other is Grand Mere, where the Laurentide Paper Co. has its mills. A few years ago, these two places were about equal in importance; indeed, Grand Mere was practically unheard of. Yet to-day we find that while Batiscan is a small struggling village of 300 people, making inappreciable progress, Grand Mere, on the other hand, is a thriving town of 5,000 contented, prosperous people.

In one case the primal basis of the industry is shipped out of the country, helping to build up a rival industry and the profits therefrom; in the other, it is used on the premises, so to speak, giving employment and a living to a thousand families or more in our own country, besides profit to railroads and dozens of other classes of the community.

It has not transpired exactly yet as to who are the sponsors for the new movement, but as we understand it, the proposal is that the Government should impose a large export duty on pulpwood from Crown lands, while on wood from privately owned or freehold lands the duty should be graduated, so as to become so high within two or three years as to practically amount to the prohibition of export altogether.

In the meantime another proposal for the solution of the problem has arisen, although whether this will be looked upon by the Government as a sufficient means for shelving the vital point of an export duty, remains to be seen. Application has been made to the Railway Commission for permission to increase the present comparatively low rates on pulpwood carried to the American border.

The railway companies claim that existing through rates on export pulpwood are not profitable and are unduly low owing to rate sharing conditions with the various roads across the line. Furthermore, the Canadian roads in Quebec, Ontario and New Brunswick prefer to haul the pulpwood to Canadian pulp and paper factories because in that case they also get the advantage of hauling the finished product. If the export freight rates are made higher, and the railway companies believe traffic conditions justify this, the result will be to make the price of pulpwood higher to the American buyer, since he must get his pulp from Canada in any case. The proposed advances amount to all the way from 33c. to \$1.00 per cord, although the average increase is said to be about 40c.

The Government is believed to look with favor upon the request of the railroads and the Intercolonial or Government railway is among those filing applications for the advance in rates, so that the Board of Railway Commissioners, when the question comes before them shortly, are quite likely to accede to the application on ulterior grounds of conservation. In the meantime, American paper manufacturers are representing that such an increase of rates is in reality a discrimination in the meaning of Section 2, and that this should call for a rescindment of the free-entry privilege.

## PREVENTION OF ACCIDENTS

In view of the interest which recently has been taken in the prevention of accidents in mills and factories, and in the enquiry into this subject undertaken by Sir W. Meredith, pulp and paper manufacturers, in particular, will find much to admire in the work of the Wisconsin Industrial Commission, which a few days ago made a tour through the mills of Appleton.

The Commission has organized several safety exhibits which managers, superintendents and foremen are asked to visit with a view to the thorough safeguarding of machinery under their care. Its members make a point of visiting factories and making suggestions whereby absolute safety may be achieved. For it must be remembered that a very large proportion of accidents are caused through thoughtlessness and carelessness, in which employer and employee share. As the Commission says in its report, "Three-fourths of the accidents occur where nobody ever goes, or on machines where nobody has ever been injured, or in places of employment where nobody has ever been known to be hurt." The Commission and its deputies have been well received, for its sole purpose is recognized to be to open the eyes both of mill manager and mill hand to the duty each owes to himself to avoid all possibility of accident.

In regard to compensation for accidents, F. W. Wegenast, on behalf of the Canadian Manufacturers' Association, has worked out details for a scheme of insurance as to the methods of assessments, management and distribution, and has submitted a strong report based on the experience of Britain, Germany and other countries which have made a serious effort to solve this difficult problem.

The plan is, in brief, a Provincial system of compensation and pension in case of permanent incapacity, the

funds to be provided three-fourths by the employers and one-fourth by the employees. Each industry or group of industries would bear a rate in proportion to its risks or dangers. It would be compulsory in all occupations and the insurance principle of a general participation would make individual burdens light. As the cost on each individual industry would be in proportion to its dangers, the employer would be more mindful of accidents and the dangers would be much lessened, not only in his own establishment, but in the establishments of other employers engaged in the same industry. The same influence would be felt among contributing workmen.

---

## EDITORIAL COMMENT.

Paper manufacturers, and, indeed, all who make use of advertizing matter for mailing to Australia, will be interested in the fact that duty stamps may now be obtained for the purpose of affixing to packets of catalogues, etc., of a dutiable character. Manufacturers of the United Kingdom have had this privilege for some time past, but much Canadian advertizing matter has been destroyed because the addressee refused to pay the duty, amounting to 12c. per pound. One of the regulations reads as follows: Paper, Manufactures of, framed (including the weight of the frame) or unframed having advertisements thereon, including price-lists, n.e.i., trade catalogues, n.e.i., show cards n.e.i., and all printed, photographed or lithographed matter, pictures n.e.i., and posters of all kinds, used or intended to be used for advertising purposes; also all printed bags and cartons; calanders and almanacs n.e.i., are dutiable at 6d. per lb. or 35 per cent. ad val., whichever rate returns the higher duty. It will be found, however, that, with very rare exceptions, the duty may be properly assessed at the specific rate of 6d. per lb. on

such matter imported through the post. These duty stamps may be purchased from the Canadian Manufacturers' Association in denominations of from  $\frac{1}{2}$ d. up to 1s. They should be affixed to the left-hand top corner of the package and must be canceled by sender before despatch by stamping or writing the date across face.

\* \* \*

The altogether too large proportion of forest material which is wasted after treatment through the pulp and lumber mills of the country has been referred to in more than one bulletin of the Forestry Department. The same extravagance is to be found across the line, for we note in a recent report of the U. S. Forest Service that mills with an aggregate cut of 5,440,000,000 board feet made a final waste of 1,870,000 cords of slabs after the best had been taken out for making laths. Something less than half of the whole was utilized for fuel, the average value being \$1.40 per cord. Large quantities were burned in the waste burner or slab pile, probably about 4,500,000 cords. It looks as if there ought to be some good and popular method of utilizing this gigantic waste from slab and sawdust. Indeed, that it can be done is proven by the fact that some mills do put their refuse to good account, although the instances are isolated. In Norway, it is worthy of note that some of the large mills are beginning to use shavings for making pulp. The shavings are first chopped small in a cutter and are then put into the boiler. The product, however, is low grade.

\* \* \*

The Paper Trade Journal, commenting on the fact that a Quebec Province pulp and paper company had defaulted in its bond interest and was involved in financial difficulties, draws the moral that perhaps Canadian paper enterprises are

being rushed forward too fast. We think that our contemporary is forgetting that one swallow does not make a summer, and that in whatever may be the industry which is under consideration there are sure to be one or two partial or entire failures. The fact that so many new pulp and paper industries have been launched in Canada during the past year or two is nothing but a sign that this country's great opportunities and resources in these lines had begun to be realized. However, the Journal's suggestions of a general character are doubtless good ones. It is well to remember that no amount of clever manipulation of the stock market, and no quantity of "water" however adroitly poured in, will take the place of the possession of abundant raw materials and power at the right location, and of good technical and selling management at the mill itself. It is not sufficient for Canada to be a wonderfully promising country for pulp and paper manufacturing in a general way; but each enterprise must be judged on its merits and particularly on the character of its working personnel. A high-sounding prospectus does not necessarily mean profits, either in Canada or elsewhere, either in the paper industry or any other.

---

—John W. Hannay has retired from the partnership of Watson & Hannay, Glasgow, and will continue business under the name of John W. Hannay & Co., Rag and Paper Stock Merchants, Importers and Exporters, with A. K. Jackson, manager to the late firm, continuing in that capacity. Mr. Hannay has had over 30 years' practical experience in all branches of the business and has visited many of the paper mills in Canada and the United States, and is therefore in a position to do business on the best terms,

## American Newspaper Publishers' Association

The following bulletin (No. 2747) has been issued by John Norris:

Paper has been offered in New York State at \$2.10 delivered.

The Canada Paper Company, of Windsor Mills, Quebec, has contracted with the Ohio Select List of thirty-five (35) newspapers for delivery of approximately 3,000 tons of paper per annum, at \$2.13 destination net 30 days. The average consumption of each paper is 100 tons per annum. Freight rates varied from fifteen (15) to eighteen (18) cents, making the price vary from \$1.95 to \$1.98 f.o.b. mill.

The Great Northern has contracted to supply an Ohio paper at \$2.15 destination, net 30 days. One of the largest concerns in the paper industry with output approximating 200 tons per day is averaging \$1.95 f.o.b. mill for all of its output. In view of the fact that it has been receiving \$2.00 f.o.b. mill for some of its paper, there must be a price below \$1.95 for another part of its production.

"Paper" of Chicago, reported that contracts were closing between \$2.12 and \$2.15 delivered.

Mr. Hastings, of the American Paper and Pulp Association, has publicly announced on more than one occasion that he had prevented cutting of prices by inducing managers of new mills to withhold quotations until they were ready to put their paper on the market. Thus far he has been measurably successful in checking serious cuts but the new production is now accumulating. The new mills are encountering difficulty in wedging themselves into the market. Cuts in prices below the softening already noted would seem to be imminent. Prices of books and wrappings and ledgers have been arbitrarily advanced by the group of manufacturers producing those grades of paper. Meanwhile, the American paper makers are shipping news print paper out of the country faster than the Canadians have shipped it in. The exportations of news print paper for July 1912, were 120 tons in excess of the importations. The exports were 5,876 tons and the imports 5,756 tons.

Before next April, the total new production of news print paper to be thrown on the market will approximate that which the International Paper Company now makes. The figures of immediate and prospective developments exceed 3,000 tons per day, an amazing advance in volume.

Commissioner Conant's report of the Bureau of Corporations, showed that the stocks on hand at the end of June increased approximately ten thousand tons over that of May. During July, stocks increased 4,020 tons. Early in July many of the news print paper mills stopped work on Saturdays in an effort to keep down the surplus stock of paper. The first intimation of that plan came from the Rumford Falls Mill of the International Paper Company, on July 2. Notwithstanding these restrictions, the news print paper market is accumulating a large stock of paper. Much of the increase may be concealed for a time by paper makers through shipments from the mills to various cities for storage in anticipation of increased demand. The paper shipped from the mill is not reported to the Government in statements of stock on hand which are confined to stock at mills. The new mills already on the market have been adding 575 tons per day to the output. This statement excludes plants in course of construction. The summer decline in number of pages printed and in circulation due to diminished business is estimated as equivalent to 800 tons per day of reduced consumption in a total of 4,500 tons per day. The newspaper strike and boycott in Chicago have contributed somewhat to lessen the demand for paper.

Then follows a long list of Canadian news items re new mills and extensions.

Canada shipped 55,563 tons of news print paper to the United States in the fiscal year ended June 30, 1912, an increase of only 2,449 tons over the previous year. It is evident that the Canadian paper industry takes a year to turn around and to adjust its wood supplies to the new conditions of free access to the attractive market of the United States.



Canada consumes 64,000 tons of news print paper per annum, or 200 tons per day, but is making 850 tons per day. American paper makers paid \$25,972,108 in the last fiscal year principally to Canada for supplies of raw material to keep their mills going.

The recent sale of fifteen water power rights by the Province of Quebec was a failure. Only four of the fifteen powers were sold and these with one exception were auctioned off at ridiculously small figures. The Provincial government will not be able to attract much capital to the development of crown land properties until it enables investors to enter the market of the United States free of duty and it cannot do that until it removes its restrictions upon the exportation of that wood from which the pulp or paper has been produced. Meanwhile, large shipments of pulps made from unrestricted woods cut on freehold lands as distinguished from crown lands are coming to the United States. Over 534,000 tons of pulp were imported in the fiscal year of 1912 of which 234,000 tons came from Canada.

The Province of Ontario has fared no better than Quebec in its offerings of crown land limits at auction. It sold the Abitibi timber limits, comprising 1,560 square miles for a rental \$3.00 per square mile per annum, or \$5,000 to Ogilvie and Anson. A device to beat around the bush and save the face of the provincial government from apparent retreat in the prohibition of exportation of pulp wood is apparent in a scheme to open part of the land to settlers who can cut freely from their licensed holdings. A somewhat similar scheme seems to be disclosed in a contract made by the Provincial authorities with Willis K. Jackson, a Buffalo lumberman, who has acquired 98,000 acres comprising the townships of Haggart and Kendry in Northern Ontario. The Colonization Company can cut pulp wood in large quantities from townships which are nine miles square. It can ship the wood into the United States or sell to Canadian paper mills for the American market. These projects may be entering wedges for the general removal of the prohibition of exportation. It is certain that the owners of Crown land limits in Ontario who are not

permitted by the provincial authorities to reach the United States market will have occasion to complain of discrimination against them, and in the interest of favored concerns.

In British Columbia, the Provincial Council took the stand that it was justified in removing the prohibition of exportation upon particular areas from which the Powell River Paper Company was cutting wood for conversion into paper and for shipment into the United States. The matter was submitted to Acting Secretary of the Treasury Curtis who decided that paper made in Canada from unrestricted wood must be admitted free of duty under Section 2 of the Reciprocity law.

Arthur C. Hastings, President of the American Paper and Pulp Association, visited Europe a few months ago and tried to induce the British and Swedish manufacturers to co-operate with the American paper makers in gathering statistics, that would inform them how the world's paper production was keeping pace with consumption. He said the competition which the United States is about to experience with Canadian paper manufacturers is "real" and not imaginary, as new mills with capacity for 1,000 tons per day were coming into the market. Describing a trip to Germany and England, he said: "They seem very much interested in the progress of the American association, and strong hope was expressed by some of the larger manufacturers that they might through closer association, gather statistics that might be of great importance to the English manufacturers. If this could be done this information could be combined with the information being gathered by our association, and the Canadian association, and eventually the paper interests of the world would be in an intelligent position to handle any problem which might arise."

---

The North Shore Power, Railway and Navigation Co., Jas. Clarke, President, now has 24 grinders, with a total capacity of 250 tons of pulp daily in full operation. The developed water power has a total capacity of 10,000 h.p., while there is a second fall capable of generating an additional 9,000 h.p.



## Congress of Applied Chemistry

The eighth International Congress of Applied Chemistry took place in Washington, D.C., September 5th, 6th and 7th. It was opened by Dr. W. H. Nichols, President of the Congress, in the absence of President Taft, through a sprained ankle.

The Hon. President, Dr. E. W. Morley, of New Haven, Conn., expressed the cordial welcome on behalf of the chemists of America to the visiting chemists of the world, and he took an especial pleasure in welcoming the chemists from those four nations whose languages are the official language of the Congress—Great Britain, France, Germany and Italy—and in whose countries chemistry had its origins one hundred years ago, mentioning in particular the name of Dalton, Lavoisier, Leibig and Avogadro. The progress of chemistry in those four countries had been well worthy of those beginnings. At that time the United States had just become an independent nation—organization, civilization and general law-making had to take first place—pure chemistry had to wait. He welcomed the nations "who were thus our masters and teachers.

Dr. H. W. Wiley, ex-chief of the Bureau of Chemistry, was chairman of the General Entertainment Committee.

The delegates visited the White House, where they were received by President Taft, who took occasion to speak of the great opportunity for reform presented by the unsatisfactoriness and great expense of litigation in connection with patents about which he naively acknowledged he knew much more than about chemistry.

The paper chemists met under the chairmanship of Arthur D. Little, of Boston, and a series of valuable papers was read.

Among these was one on "The Effect of Variable Grinding Conditions on the Quality and Production of Mechanical Pulp," by McG. Cline and J. H. Thickers, of the Forest Products Laboratory, Madison, Wis. Tests on pulp stones, in regard to speed, surface, processes, etc., led the authors to the conclusions that:—

1.—Power to the grinder increases directly with the speed and pressure, and inversely with the degree of sharpness of

the stone. There is also a very slight increase with the temperature. Under like conditions of all other factors the power to the grinder is less for steamed wood than for green or seasoned wood untreated.

2.—Production of pulp in 24 hours varies directly with the pressure, speed, and the degree of sharpness of the surface of stone. Less pulp is obtained in 24 hours from seasoned wood than from green, and still less from steamed wood, all other conditions being the same.

3.—Horse power consumption per ton on untreated wood increases as the pressure decreases according to a fairly definite law; it is lower on sharp stones than on dull and it increases as the speed decreases in much the same manner as is the case with pressure. There is, however, not so much difference between the power consumption per ton at low speed and at high speed as there is between power consumption at low pressure and high pressure. The temperature has very little influence on power consumption; it is slightly lower at high temperatures. The power consumption per ton is higher for seasoned wood than for green wood, and still higher for steamed wood than for either seasoned or green wood ground under the same conditions. Conifers require more power per ton of pulp produced than hard wood.

4.—Yield of pulp per cord is greater at high pressure than at low, and this is also true of screening. There is, however, not as much fine material lost in white water when high pressure is used. The surface of the stone does not greatly influence the yield per cord. The yield is slightly higher at high speed than at low and it is directly proportional to the bone-dry weight per cubic foot of wood.

5.—The quality varies greatly with the surface of the stone, less greatly with the pressure, and least with the speed. The weight per cubic foot and character of wood influence it to a marked extent, especially the latter. The temperature has a marked influence, pulp of high quality being obtained at higher temperature. Pulp of better color can be obtained from

green wood than from seasoned, and stronger pulp can be obtained by steaming the wood prior to grinding. The quality of paper produced under exactly the same conditions but made of pulps produced at different grinder pressures varies directly with the grinder pressure and

the horsepower consumption per ton of pulp. Pulp of highest quality can only be produced from a definite kind of wood by the expenditure of a large amount of power.

Some of these papers will be reprinted in this magazine.

## The Forestry Convention

The sixteenth annual convention of the Canadian Forestry Association, which took place in Victoria under the auspices of the British Columbia Government was a great success in every way. The fact that it was held in the Pacific Coast region, a territory which to-day probably holds the bulk of the merchantable timber in Canada, lent additional interest to this year's meeting, a point which was readily recognized by the large number of those locally interested who were in attendance. The interests of other provinces were by no means neglected, however.

The recently formulated forestry policy for British Columbia received unstinted praise from men who know, from every province in the Dominion, and the Hon. W. R. Ross, Minister of Lands, who was responsible for this forward move, was loudly cheered. He has a singularly able lieutenant in Mr. H. R. MacMillan, who was recently appointed Chief Forester for the Province.

The opportunity of the presence together of so many men prominent in Crown land and forestry matters, from coast to coast was seized hold of in the attempt to unify the various provincial policies.

Sir Richard McBride, Premier of British Columbia, welcomed the delegates in an eloquent speech, in which he dwelt upon the necessity for creating a better understanding and co-operation between the trained forester and the practical lumberman.

In a very practical and detailed manner, the position of the various provinces was analyzed, particularly those of Ontario and Quebec. Ontario's problem is regarded as a two-fold one, that of conservation from North Bay to the Manitoba boundary, and reforestation in southern Ontario. The

fire-protection system of Ontario was explained and discussed by Deputy Minister Aubrey White. In the course of the conference one of the visiting Ministers stated he understood that Hon. Frank Cochrane, when Provincial Minister, was inaugurating a policy to place the entire control and management of Ontario forest protection in the hands of one head under a new department, and that the announcement of this policy was pending.

There was some straight talk concerning the existing situation, and the waste of low-grade timber which prairie settlers would eagerly welcome. Mr. E. J. Palmer stated that Mr. J. J. Hill, the railway magnate, told him that fifty thousand cars of lumber were being wasted every year by Pacific coast lumbermen. "There have been too many glittering generalities in forestry reform discussions," said the Minister of Lands and Forests, Mr. Ross, in the course of his address. "Thus it comes that the average timber owner would as soon think of allowing what he imagines is meant by forestry to interfere with the practical handling of his limits as he would permit the science of eugenics to dictate to him whom he should marry."

Mr. John Hendry, president of the association, in his address, made special reference to the question of keeping fake settlers out of timberlands.

"We are coming further," he said, "to clear realization that the two main enemies of the forests and of the continued prosperity of certain sections of the country, are fire and the pretended settler, that is, the man who goes in to defraud the country of the timber under the guise of settlement. These so-called settlers, after they have taken the timber, leave the

land in such a state that it will neither produce crops of grain nor timber, and then move on to new forests to repeat the operation. If, on the other hand, the lumberman had had these lands under proper methods, they would produce timber for many years to come, and later on by plans of reforestry could be made to grow a new crop. Our first need, however, is to protect the crop we have. With care the timber in Canada will last many years and this care is our first consideration.

"First and most important of our duties is that we should satisfy ourselves that we have done and are doing all that we ought in regard to fire protection before we go on to reforestation. In fact, until we have banished fire from our forests money spent on reforestation will be simply thrown away. We must save what we have and use it as conservatively as possible, that is to say, reduce waste in the woods and the mill to the lowest point consistent with the economical handling of the product and the making of profit. This is easy to say and we have been saying it for some time, but we must realize that if our forests are not to be burned up, the governments of Canada, federal and provincial, must approach the subject more systematically than they have yet done. Each province must lay out its work just as systematically as a city fire chief would lay out his plans to cover the city, and besides there should be co-operation between the provinces and the Dominion, where their respective jurisdictions join or overlap. This, of course, means the expenditure of money, but upon what can money be spent better than on the protecting of our natural resources? To keep 'fake' settlers out of areas suited principally for timber, requires first a knowledge of the country, which will show where such areas are, and the power in the various governments to resist political pressure brought to bear upon them to allow pretended settlers to locate on what is chiefly valuable as timberland. Surveys should therefore be made as rapidly as possible to ascertain the areas of absolutely forest land, and the whole forest staff should be free from any partizan influence, so that it will not be silent when

measures antagonistic to the good of the forest are proposed or when parties endeavor wrongfully to enter upon forest lands."

Hon. W. R. Ross showed how the Forestry Commission had led to the passing of an act for the systematic organization of forest work in the province. The two main questions to be dealt with had been the preparation of new legislation and the organization of a forest service. It had also been immediately necessary to enlarge the fire warden service for the dry season then approaching. This was successfully done by doubling the staff of fire wardens, dividing them into ten groups and providing for efficient inspection of their work. The 257 fires which had been fought during the season of 1911 cost the department only \$30,000 and the up-keep of the patrol force had cost \$112,000. He next told of the difficulties which had been experienced in securing capable and practical foresters for the carrying out of the forest legislation which had been passed. This, however, had been satisfactorily arranged. He also announced that a school of forestry will be established in connection with the University of British Columbia.

#### CANADA PULP AND PAPER TRADE.

A report of the Department of Trade and Commerce shows that both exports from and imports into Canada of paper for the three months ending with June 30th this year were greater than in the corresponding period of 1911. Imports of paper and manufactures thereof for that quarter totaled \$1,927,687, as compared with \$1,468,678 in the previous year. They comprised \$392,553 coming from Great Britain and \$1,347,110 from the United States. Exports of paper were \$950,875 this year, comprising \$135,481 to Great Britain and \$511,975 to the United States, compared with \$751,576 last year. Exports of pulp from Canada also increased this year, pulp blocks totalling \$1,350,101, all to the United States, an increase of nearly \$150,000 over the same period last year, and manufactured pulp was shipped to the value of \$1,040,680, an increase of about \$90,000. Of this \$950,310 worth went to the United States and \$82,532 to Great Britain.

# The Soda Process for Manufacturing Cellulose\*

BY E. LUTERMEISTER

It is known in a general way that increasing the time of cooking, the amount of caustic, or the steam pressure will diminish the yield, but the exact relation of these three factors has, so far as we have been able to discover, never been worked out. Another point on which no information was available was the consumption of caustic soda in cooking wood and the influence of this consumption on the yield and bleaching properties of the fiber produced. As it seemed desirable to obtain this information a series of cooks of popular wood was made with this object in view.

in a small rotary digester heated by a gas flame. At the end of each cook the black liquor was sampled, the fiber washed and its yield carefully determined.

The black liquor was analyzed in the following way. To 300 cc. of water containing 15 cc. of barium chloride solution (400 grams per litre) there was added from a pipette 25 cc. of the black liquor. This was then titrated with normal acid and the end point determined by removing a drop at intervals and allowing it to fall into a thin layer of dilute phenolphthalein solution contained in a beaker. When the drop no longer produced a pink color the

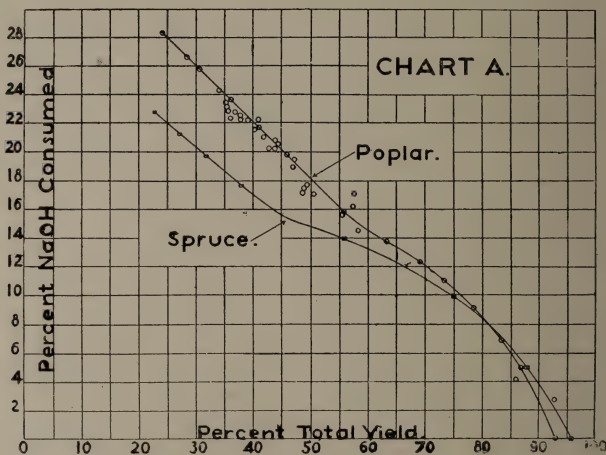

The wood used was in the form of the regular chips employed in pulp mill practice, and consisted almost entirely of two species of poplar, *Populus tremuloides* and *P. grandidentata*. The cooks were made in two ways; those in which less than 10 per cent. of caustic was used being digested at about 95° C. in a copper flask fitted with a reflux condenser, while those with over 10 per cent. of caustic were cooked

reaction was considered complete. A second test was then made by evaporating 25 cc. of the black liquor to dryness, burning off the organic matter and titrating the soda ash present with normal acid, using methyl orange as an indicator. The relation of these two tests gives the causticity of the black liquor, and by comparing this with the causticity of the original cooking liquor the amount of caustic used up in the process can be readily calculated.

\*—Paper read at Eighth International Congress of Applied Chemistry, New York, Sept. 9th, 1912.

The results of the entire series of cooks are shown in chart A in which the total



yield, whether of good fiber or of merely softened chips, is plotted against the caustic consumed. Both of these are expressed in percentages based on the bone-dry wood used. The starting point of this curve is taken as the yield obtained when finely divided chips are extracted with water at 95° C. till the extract is colored only very faintly yellowish. This chart also shows a curve plotted in the same way from the results of a few cooks of spruce chips. It is seen that in a general way the reactions follow the same course, though the slight divergence of the upper portions of the curves seems to indicate that the celluloses being acted upon are different in their composition.

A study of the curve for poplar shows that between the points of 14 and 19.5 per cent. caustic soda consumption the relation between the yield and the caustic soda used up is not so definite as it is beyond these points. This may perhaps be due to the fact that within this range the transition from chips to fibre takes place, while below 14 per cent. and above 19.5 per cent. it is practically all chips and fiber respectively. It is seen that the reaction taking place up to a consumption of 15 per cent. of caustic is quite different from that above this point. This probably indicates that in the first portion of the cook the non-cellulose constituents of the wood are being dissolved most rapidly, while after 15 per cent. of caustic has been used up the residue is as nearly pure cellulose as the process will yield and from this point on is dissolved as a whole. There is, then, little to be gained, so far as the purity of the product is concerned, by making the cooking conditions severe enough to use up more than 15 per cent. of caustic soda. It is, however, quite probable that the additional cooking would impart to the fiber certain desirable physical qualities which would not be in evidence in the less drastic cooks.

In each of the cooks in which the chips were sufficiently acted upon to produce fiber a study was made of its bleaching qualities in connection with the caustic consumed, the strength of the solution at the end of the cook and the percentage of residual caustic based on the bone-dry

wood. It was expected that the bleach required would depend very largely on the amount of caustic consumed but it was proved that all three of the above factors could be varied within quite wide limits without appreciably changing the amount of bleach required. Thus fiber bleaching with about 7 per cent. of bleach was produced in cooks where the consumption of caustic varied from 20 to 25 per cent., the residual caustic from 3.5 to 8 per cent., and the strength of solution at the end of the cook from 8 to 22 grams per litre of caustic soda. It appears to hold true that a low consumption together with a slight excess of caustic will give a hard bleaching fiber while if the excess is greater the fiber will bleach easier, even if the consumption of caustic is the same or slightly less.

It is highly probable that the bleaching properties of the fiber depend on certain definite combinations of the three factors mentioned, but the data available are not sufficient to determine positively the laws which govern the results.

In considering the curves shown on chart A it is to be noted that the points plotted were determined under very widely varying conditions of treatment. Thus the steam pressure has varied from 70 to 130 lb., the caustic added from 22 to 50 per cent., etc., yet the yield seems to be perfectly definite for any given consumption of caustic, regardless of how this consumption was caused to take place. This fact, taken in connection with the slight variations in bleaching properties of fiber produced under such different conditions, leads to the conclusion that in the cooking of wood the important point is to use up a definite percentage of caustic and that so far as the character of the product goes it is apparently immaterial whether this consumption is caused by time, temperature, strength of cooking liquors, or any other factor.

It should, therefore, be possible to ascertain the condition of the stock in the digester at any time by making an analysis of the black liquor, and thus avoid over-cooked or under-cooked fiber. The chief reason why this cannot be done at present is the length of time necessary for



the determination of the total soda in the black liquor. If a rapid and accurate method could be devised for this test it is thought that this manner of following the progress of the cook would prove very valuable in the soda process.

In conclusion I wish to acknowledge my indebtedness to S. D. Warren & Co., in whose laboratory this investigation was carried on, and to my associates for much valuable assistance in obtaining the original data.

## Consumption of Heat in the Indirect Sulphite Digesting Process

A Paper Read by A. W. Bergoo Before the Swedish Society of Paper and Cellulose Engineers, February 24th, 1912.

(Specially Translated for the Pulp and Paper Magazine from Der Papier-fabrikant.)

In the following will be given a short statement of the changes in the indirect cooking method for strong sulphite pulp, which have taken place during the last few years, especially with regard to a saving of fuel.

The digesting early in the 1900's was usually conducted in Sweden so that live steam was let in into the digesters after they had been charged and steamed and without any regard for the consumption of steam. All attention was given to obtaining a good pulp and to get it cooked ready in a certain time. If the digesting process sometimes required longer time

named method was quicker and gave the same results. The insulation of the pipes in the digesters by the lime is something that still occurs, and probably always will occur, as long as this method of digesting exists. At present, however, most of the disagreeable consequences connected with the lime insulation with regard to the fuel account have been eliminated.

One mill arranged its digesters early in the year 1900 in the manner shown by the sketch. It must now be supposed that the digesters after some time intermission again are to be started up and that digester No. 1 is the first to be started.

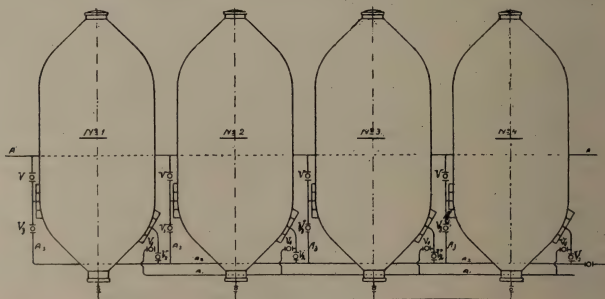

than usual, even if the valves both for letting in and blowing out steam were completely open, somebody was sent in into the digester, as soon as it was empty, to hammer the lime away from the pipe. Another method was to let steam through the pipes and at the same time wash them with cold water on the outside. The last-

A is the pipe for live steam; the steam leaves pipe A through the valve V, passes through the pipes in digester No. 1, leaves, condensed through valve V<sub>1</sub>, and is carried away through the pipe A<sub>1</sub>. The steam is passing in this manner for, for instance, 6 hours, until it is time to put digester No. 2 under steam. Then the valves V<sub>2</sub> and V<sub>3</sub>

on digester No. 2 are opened, but V is left closed. The steam then passes from A through the valve V, through the pipes in digester No. 1 and goes through valve V<sub>2</sub>, pipes A<sub>2</sub> and A<sub>3</sub>, further through valve V<sub>3</sub>, and finally through the pipes in digester No. 2 and valve V<sub>1</sub> to the discharge pipe A<sub>1</sub>. The valve V<sub>1</sub> on digester No. 1 was only slowly shut off in order to avoid noise and water shocks, and first after the connections had been arranged as described above. The waste steam from digester No. 1 is, of course, not sufficient for digester No. 2, so that some live steam must be introduced through pipe V. The digesters are now working for six more hours in this way, until digester No. 3 is to be started. The valves are handled in the same manner as described above, then valve V<sub>3</sub> on digester No. 2 is shut off and the quantity of steam required for this digester is taken from the live steam pipe A. Now three digesters are working, two with live steam from pipe A and the third with waste steam from the two first. And thus the digesters work for six more hours until digester No. 4 is started and the valves handled in the same way as before. Eighteen hours have now passed since digester No. 1 was started, and if it is ready to blow off, so does No. 4 obtain steam from digesters No. 2 and 3. It was found that a very small quantity of live steam usually was sufficient for the digester with this arrangement, when they first received the waste steam from two previous digesters.

The next novelty was that when one digester should be started, acid was taken from one of the other digesters, which was under high temperature and pressure. This made it possible to charge only about 90 per cent. of the quantity of acid required into the digesters, which had been used before; the remaining 10 per cent. were taken from other digesters, and in this way also that heat was utilized, which was contained in the acid from the digester under pressure.

The next novelty consisted in steaming the wood in the digester before the acid was filled in. The steam caused the chips to sink together so that 10 to 12 per cent. more chips could be filled in; when this

had been done, steam was let in again for about 10 minutes, depending upon how long the digester had been left open; then the bottom valve was closed, and the digester was left for some time, to make sure, that the wood filled in the second time had been thoroughly steamed. In this way the advantage was obtained, that 10-12 per cent. less acid had to be heated.

Another detail already tried in the end of the 1890's, viz., the insulation of the digesters, has now been taken up again in several mills.

From the above can be seen that several experiments have been started during the ten years, and that a saving in fuel has been effected without having any influence on the quality of the pulp, when the work has been done correctly.—C. E. B.

#### WAVY ART-PRINT PAPERS.

When calendaring art-print paper between plates great care must be taken that the packets are not fed into the machine until the latter is up to speed; the packets, therefore, should not be brought directly to the feeding place and the machine then started, for this would result in the first edge of the paper becoming stretched to an abnormal extent, the effect being greater the higher the pressure applied and the more irregular the running of the machine. Distinctly marked waves, therefore, appear at the edge first entering the machine, and these tend to become worse, because at this side of the paper the sheets cannot lie snugly above one another, and the air can consequently more easily penetrate than at the other three sides. Moreover, calendaring rolls which imperfectly fit one another may also cause the formation of waves. The paper, after being delivered to the printing-house, must be given an opportunity to adjust itself to the humidity of the air prevailing there. Excessive dryness or humidity may be avoided by sprinkling the floor with water or by heating. The paper should be firmly wrapped in a good paper covering, and the wood used for packing must be thoroughly dry.

## Development of Chemical Wood-Pulp Industry in Sweden and Re-Claiming of By-Products

An abstract from an article "Teknisk Tidskrift," specially translated  
by C. E. Bandelin

The increase in the consumption of paper during the middle of the eighteenth century caused a strong demand for more raw materials. This depended mostly on the fact that only clean and colorless rags then could be used for white papers. This difficulty was however diminished in the end of the century by the invention of chlorine-bleaching. The invention of the Fourdrinier machine in 1799 again caused a scarcity of raw materials, but the situation was improved by the appearance on the market of ground wood-pulp invented by Keller in 1844. The paper industry was, however, first enabled to reach its present development through the manufacture of brown ground wood-pulp, soda and sulphite pulp, but as we all know, the world is at present again being carefully searched for new raw materials for paper making.

Piette writes 1838 in his text-book about paper making, that it is impossible to make good paper from wood and gives the advice instead to cut or saw the wood in thin discs. Thirty-four years later the first sulphite pulp was made by C. D. Ekman at Bergvirk, Sweden.

Already from the beginning it was the intention of the different inventors to utilize also the products, which are dissolved during the digesting process. Early in the 1860's it was shown that sugar, which could be fermented, was obtained when the wood was digested with 10% hydrochloric acid. The method did not pay and the manufacture was discontinued, but nevertheless alcohol was made on a manufacturing scale as a by-product from the chemical pulp industry about 50 years later by the Swedish engineers Ekstrom and Wallin.

The chemical wood-pulp industry was started in 1853, when C. Watt and H. Burgess obtained a patent to digest wood with soda lye at a high pressure. They boiled the wood in vertical, closed digesters with soda-lye of 12° Be during six hours and at a pressure of about 63 lbs.

In his English patent of 1857 Houghton suggested high pressure and stronger lye (165-180 lbs. and 6½-7° Be). The first mills in Sweden were built in 1870.

The chipped wood was crushed between rolls and afterwards packed in baskets of perforated sheet-iron, which were introduced into the digesters, standing on cars. The digesters were horizontal and ten baskets corresponded to one charge. After closing the digesters the lye was pumped in and the firing was started. In the beginning no gauge was used, but the fire was taken out, when the temperature had reached about 370°F. corresponding to a pressure of about 200 lbs. The digester was then left for some hours and the steam was blown off. The dark colored pulp was taken out, washed, strained, taken up on a wet-machine, pressed and dried. A cork could be made ready in sixteen hours.

Several other mills were built during the following years, but considerable experimenting was required before the necessity of reclaiming the waste lye was understood.

The competition with the sulphite mills caused an unfavorable change in the soda pulp industry early in the '80's. The invention of the German engineer Dahl to add sulphate of sodium instead of the soda last, was therefore a very important improvement. This method was used both for wood and straw pulp. More pulp was obtained per charge, and it was stronger and easier to bleach. The lye consisted of free alkali and carbonate and besides also sulphide, hyposulphite and of course sulphate.

The use of sulphurous acid for the digesting of wood was suggested in 1866 by the American Tilghman. He spent the greater part of his fortune in experimenting and gave up his experiments without having developed the method to any practical use. A saleable sulphite pulp was first manufactured by C. D. Ekman in Bergvirk, Sweden.

He started there to make wood-pulp by treating sawmill refuse with water at a high temperature. A coarse, brown pulp, which could be used for wrapping paper, was obtained. He had before used magnesium sulphite for the bleaching of ground wood-pulp and after long laboratory experiments he found that it could be used also for the dissolving of the incrusting substances in wood. The sulphite mill at Bergvik was started Oct. 3, 1874. It had eight small jacketed rotary and lead-lined digesters, giving about 800 pounds per charge.

Ekman kept his invention secret, but it became known that sulphur was used. It was first believed that sulphuric acid was used, but it soon leaked out that it was sulphurous acid. The next sulphite mills in Sweden were Billerud, built by Flodquist in 1883, and Storvik, by Folin in 1888.

At the same time the sulphite pulp industry had been energetically developed in Germany, especially thanks to the simple and practical methods introduced by A. Mitscherlich. Two other names, which should not be left out in connection with the German sulphite industry, are E. Ritter and K. Kellner.

Of utmost importance for the soda pulp industry is the reclaiming of the alkali; a complete washing out of the lye from the pulp, the evaporation of the lye, its combustion and causticising. The lye was first evaporated in closed vessels and the scum was used for different purposes. Afterwards boilers, economizers, etc., were built in behind the soda ovens and the calorific efficiency of the lye was thus utilized.

A percentage of selenium in the sulphur or pyrites used in a sulphite mill has been shown to have much more serious results than previously believed. The selenium seems to act catalytically so, that the  $\text{SO}_2$  is transformed into  $\text{SO}_3$ .

The sulphite digesters are now being built bigger than before. Superheated steam has been used in some mills, cooking by indirect steam. The digesters are usually lined with cement lining and silicate of soda, with or without bricks. The time of digesting has become shorter. The

experience has shown that it is more advantageous when bleached pulp is to be made, to stop the digesting process earlier and to use more chlorine, than to continue the cooking to greater whiteness of the pulp and use less chlorine. The higher amount of pulp obtained from a charge amply pays for a somewhat higher consumption of chlorine, and the pulp also becomes whiter. It is indispensable when clean sulphite is to be made, not only to carefully watch the wood room, but also not to try to effect a saving on screens and water. Centrifugal screens are being used for strong sulphite. Rotary and flat screens are still used for pulp to be bleached.

Bleaching beaters are being built bigger. A thorough mixing of the pulp, an even bleaching and a saving of chlorine has been obtained with propeller beaters, which require very little power and work silently.

It has been found profitable to generate steam of low pressure separately for the drying of the pulp.

It is apparently the great woods and the abundant water powers in Sweden which have mainly contributed to the rapid development of the chemical wood-pulp industry in that country. It can, however, not be denied that this development has been mostly quantitative, so that the quality of the produced pulp has not been given due attention.

The limited quantities of raw material at hand also make an increase of the production in the same ratio as till now undesirable, and the chemical wood-pulp industry will therefore find it necessary to manufacture a higher grade product and, not least, to try to get out a better value of the limited quantity of timber in the country by means of reclaiming by-products.

Chemical wood-pulp was manufactured for 25 years without hardly any chemical theory. The cellulose digesting process was developed purely empirically; soda and sulphite pulp became articles sold all over the world without the composition of the incrusting substances in the wood or the chemical processes dur-



ing the digesting of the wood being satisfactorily known.

The chemistry of the cellulose was directed in the '80's towards practical purposes by means of the manufacture of artificial textile fibres. If the cellulose proper offers great difficulties to chemical researches, there is, however, a still more mysterious substance in the lignine, when the woods grows the cellular membranes of the plant are submitted to considerable chemical changes, at the same time as the protoplasmatic activity decreases. It is incrustated with different substances which fill up the intercellular spaces of the plant. The substance or substances which cause the lignification are called lignine.

Professor P. Klason regards the lignine as a substance, similar to a glycoside, one part of which is a carbo-hydrate (cellulose), and the other part is of a complicated aromatic nature, containing one oxypropylene molecule, one aldehyde molecule, one hydroxyle molecule, and several oxymethyle molecules.

The aromatic constituents vary in different kinds of wood, so for instance is the spruce lignine mainly to be regarded as a condensation product of coniferyle and oxyconiferyle-alkoholes.

Klason finds, however, that lignines as well as proteins and most of the carbohydrates occurring in the nature are highly condensed colloidal and not uniform chemical substances.

Several theories about the chemical reactions during the sulphite digesting process have been suggested.

Tilghman and also Mitscherlich and Frank supposed, that the lignine was reduced by the  $\text{SO}_2$  during the digesting process, Harpf has shown that this was not the case, and arrived to the result that the  $\text{SO}_2$  was reduced in the digester and occurs in the lye as an organic combination. Lindsay and Tollens have shown that the lye contained ligno-sulphonate of lime of the composition:  $\text{C}_{33}\text{H}_{30}(\text{CH}_3)_2\text{S}_2\text{O}_{22}\text{Ca}_1$ , which must have been formed from the lignine. Klason supposes that lignyle-alkohol, which contains an unsaturated complex, combines with the  $\text{SO}_2$ . Besides, there occurs a polymerization to  $\text{C}_{36}\text{H}_{40}\text{O}_{12}$  and a salt of lime,

$\text{C}_{15}\text{H}_{10}\text{O}_8\text{SCa}^{1/2}$ , soluble in water, is formed.

Most of the organic substances, which are brought into solution during the soda or sulphate digesting process, are still of an unknown chemical composition, and have not been technically used, with exception for the utilization of their caloric efficiency in the soda ovens. They have a more or less acid character and can therefore be precipitated with acids from the lye.

According to Klason the carbo-hydrates in the wood are transformed during the alkaline digesting process into lactonic acids, which neutralize the alkali, and the lignine molecule is disassociated in lower molecules, which are dissolved in the alkali. The lignine prepared from the black lye had about the same composition as the one made directly from the wood. Klason has also shown the presence of meta-saccharine acid and other saccharine acids.

The black lye besides contains considerable quantities of formic and acetic acids.

Klason found for 1000 grs. of the substances dissolved from the wood in the black lye:

	Grs.
Carbonic acid .....	12
Formic acid .....	70
Acetic acid .....	7
Lactone acids .....	326
Lignine .....	313
Substances, soluble in ether .....	232

Rinman has obtained as an average from several experimental digestings of wood with caustic soda lye:

	P.C.
Turpentine .....	0.4
Wood alcohol .....	0.5
Rosin, rosin oils and fatty oils ...	0.75
Humus substances and humus acids.	31.0
Humus acids soluble in water .....	20.0
Lactones and lactone acids .....	20.0
Acetic acid .....	3.0
Formic acid .....	3.0
Cellulose .....	37.0

and besides ammoniac, amines and carbonic acid, which were not determined.

After a finished digesting with lye of usual composition about one-half of its



percentage of hydrogen sulphide is found to be combined with the lignine in the black lye. On account of this and of the formation of volatile methyl-sulphide combinations the sulphide of sodium in the lye will only gradually become effective as sodium hydrate. This circumstance explains the protecting influence of the alkali sulphide on the fibre.

Lowe had already in 1861 obtained a patent on a method to regenerate the black lye from the digesting of straw by means of carbonic acid. According to an English patent of 1871 by Tessie du Motay, the rosin acids were precipitated with carbonic acid, the remaining lye was causticized with lime, and the last traces of rosin acids were eliminated with barium hydrate.

The difficulty to separate out the precipitate without considerable losses of alkali, however, caused the method to remain without any practical importance.

The precipitate can, however, according to Rinman, be obtained in an easily washable form, if the lye by concentration or by the addition of salts or hydrates has been brought up to a certain spec. gravity, and carbonic acid is introduced at a temperature of about 75°C. Rinman calls the substances, which are precipitated by carbonic acid, ulmine substances and those precipitated only by stronger acids, ulmine acids. The quantity of ulmine substances in the lye from pine wood amounts to about 40% of the weight of the dry wood.

The rosins, contained in the wood occur in the lye in form of rosin soap, which can easily be reclaimed. This rosin soap (liquid rosin, pine oil), has up till now found some use for the sizing of paper or as a lubricant.

The sulphate method had, notwithstanding its great advantages, also as is well known, a great disadvantage on account of the disagreeable smell, which even has caused petitions to be sent to the different governments to completely prohibit the working of sulphate mills. Probably just the question about the smell was the first reason for a closer study of the chemical processes during the sulphate digesting process.

The nature of the smelling substances was first determined through researches by Professor Klason. The metoxy-complexes in the lignine are saponified by the alkalis or alkali-sulphides during the digesting process. In the first case methyl-alcohol is formed and in the second methyl-mercaptane. If the lignine is supposed to have the formula  $ROCH_3$ , these combinations are formed according to the following formulæ: 1,  $ROCH_3 + NaOH = RNa + CH_3OH$ ; 2,  $ROCH_3 + NaOH = RNa + CH_3SH$ .

The methyl-mercaptane has, however, a negative character and can therefore in the presence of an alkali be changed into an alkali-mercaptide: 3,  $CH_3SH + NaOH = CH_3SNa + H_2O$ , which again can react with the lignine according to the formula: 4,  $ROCH_3 + CH_3SNa = RNa + CH_3SCH_2$ .

Always when an organic sulph-hydrate (mercaptane) is formed, the corresponding sulphide is obtained at the same time in this way.

The methyl-mercaptane probably is contained in the vapors over the liquid in the digester, a sulphide would form methyl-sulphide with the lignine or be dissociated to methyl-sulphide and sodium sulphide, if combined with the alkali in the lye:  $2CH_3SNa = (CH_3)_2S + Na_2S$ .

The quantity of methyl-sulphide and methyl-mercaptane obtained from one charge, was found by Klason to be very small, viz., about 200 gr. methyl-sulphide and 15-20 gr. methyl-mercaptane per charge of 24 cub. metres. Of the substances containing sulphur and formed during the digesting process, about 67% are sent out in the air from the soda ovens, and 33% from the digesters. He has also shown that the percentage of methyl-sulphide increases when not enough alkali is present, and on the other hand that the percentage of methyl-sulphide increases with an increased quantity of alkali. Pine gives under the same circumstances about double the amount of methyl-mercaptane as compared with spruce.

Klason has found that about 99% of the substances containing sulphur and formed during the destructive distillation in the soda ovens, are oxidized to  $SO_2$ . This  $SO_2$ , which has been formed through the

combustion of merkaptane and hydrogen sulphide, is neutralized to about 80% by the alkali, which is volatilized in the generator. The remaining 20% exist in free form in the combustion gases and only a small percentage is combined with ammoniae or amine-bases. The quantities of SO<sub>2</sub> and sulphites in the combustion gases are, however, too small to be reclaimed by washing.

Several methods have been patented to destroy the evil-smelling substances by means of oxidizing agents, such as chloride of lime, permanganate, bichlormate, vitriol, nitrous gases, etc. A spray of water in the smoke canals has also been suggested.

Klason shows that the smallest quantity of evil smelling substances is formed when the soda ovens are handled rationally. He insists upon that the combustion in the rotary oven ought to be as complete as possible, that the lye ought to be introduced concentrated in the oven, so that the evaporation of the water does not too much lower the temperature, and that the gases from the digester ought to be blown off so long as the distillate has a bad smell. The more concentrated the lye (or the dryer the wood) the easier the desired result is obtained. Klason also suggests to absorb the gases from the digester in strong fresh lye, which afterwards is to be causticized in the soda oven.

It has been said that the general desideratum to get rid of the sulphate smell is identical with the industries interest to utilize the raw material so completely that no valueless refuse products result. The researches which will be mentioned in the following are important contributions in this direction to the solving of the question of smell.

The condensate from the gases blown off from the digesters separates in two layers, one a milky water solution and one an oil, the turpentine. It has been found that the turpentine contains pinene as the only distillable carbo-hydrate, and besides in small quantities polyterpenes. The optical properties of the oil correspond with turpentine obtained from spruce pitch. It contains also sulph-hydrates

which give the oil a very disagreeable smell. Of these two were isolated, viz., methyl and allyl sulph-hydrates Klason and Person suggested for the purification of the oil to treat it with sulphuric acid of 50% and afterwards with water or a weak soda solution and finally to distil it with steam.

The condensate from the blowing off of sulphate digesters was analyzed and found to contain ammoniae, hydrogen sulphide, methyl-merkaptane, methyl sulphide, methyl-alkohol. A heavy oil with boiling point 110°C, turpentine, ammonium carbonate (sesqui).

Of these solutions it was the methyl-alkohol, which in the first place attracted the attention on account of its quantity. Bergstrom and Fagerlind calculated that in the condense water, which amounted to 7% of the contents of the digester, were found 40% of the methyl-alkohol, that had been in the digester. This whole quantity of methyl-alkohol had however, not been formed during the digesting process. Part of it had been blown into the solution to be causticized, so that the methyl-alkohol was circulating in the mill. Besides some black lye had been added to the fresh lye during the digesting.

Bergstrom and Fagerlind found also that by digesting with fresh lye alone about 13 kg. of methyl-alkohol were found per ton pulp, independent of, if spruce or pine was used. Of this quantity about 40% could easily be reclaimed, corresponding to 5 kg. methyl-alkohol per ton pulp. These figures of course vary with the method of digesting and the quality of the lye. The alcohol solution obtained contained about 1%, but if part of the condensate was taken out nearer to the digester, so could the alcohol be divided in two condensates of O<sub>2</sub> and 1.7% respectively. The percentage of acetone in the methyl-alkohol was 1.2%.

The same substances, which had been found in the condense water were found as impurities in the turpentine.

The raw sulphate oils analyzed:

	Raw oil fr. spruce	Raw oil fr. pine
Methyl-merkaptane. . .	1.6-4.3%	0.5-4.1%
Methyl-sulphide. . . . .	10-24	4-19.3
Methyl-disulphide. . . .	3.5-4.6	

Two unknown oils with:

Boil. pts. 149° and 153° C. . . . .	2.0%	1.0%
Turpentine. . . . .	48-63	70-87
Undistillable residue . .	10-20	5.6-7.5

and besides smaller quantities of ammoniac, hydrogen sulphide and methyl-alcohol to the volatile substances, fromed during the digesting and which are found as impurities in the turpentine, seem to occur in about the same quantities when spruce or pine is digested, but as the pine on the other hand gives eight times as much turpentine as the spruce, so is it evident that the turpentine from spruce must be less pure than the turpentine from pine. A carefully managed distillation has been found to be most important for obtaining pure products.

H. Falk has given the following data as results, obtained per ton pulp from pine:

	R oil kg.	C. water kg.	Tl. kg.
Ammoniac. . . . .	0.180	0.180	
Methyl-merkaptane . . .	0.062	0.060	0.122
Methyl-sulphide . . . . .	0.927	0.170	1.097
Methyl-alkohol. . . . .	5.000	5.000	
Methyl-disulphide. . . .	0.103	0.050	0.153
Turpentine. . . . .	8.487	0.920	9.407
Undistillable residue. . .	0.721	0.721	

A low calculation of the value of these products gives a sum of \$2.05 per ton pulp.

Among other by-products from the soda pulp industry is further the lime refuse to be mentioned. At the Skutskar pulp mill lime sand bricks are manufactured since several years from this lime refuse. The sulphate lime has further been used as a fertilizer. In some cases it has been found to be of advantage to store the lime over the winter together with peat.

While the waste products from the soda pulp manufacture find different ways out from the mill, through the black lye and the gases from the soda ovens, blowing-offs from the digesters, etc., and a com-

plete reclaiming consequently must be rather complicated, so the case seems much simpler for the sulphite pulp manufacturer, who mainly has all his waste products in the spent lye. The sulphite pulp manufacturer has, however, in fact more difficulties to utilize the waste products without any residue and with an economical result than the manufacturer of sulphate pulp.

The first ten years of the sulphite pulp industry were mainly given up to improve the technical methods of manufacturing, although the question of utilizing the waste lyes by no means was lost sight of. The increase in the production of sulphite pulp in the '80's however caused difficulties on account of the pollution of the rivers, which difficulties again brought the problem of utilizing the waste lyes to the front.

Professor Klason's researches over the purification of the sulphite waste lyes have given the theory for or method which at present is used to advantage by a number of mills. This was perhaps the first step to reclaim the organic substances from the sulphite waste lyes and was the indirect cause to the manufacture of alkohol from the waste lyes\*. This process must at present be generally known, viz., how the lye is neutralized, aerated, fermented and the alkohol distilled off, and it will therefore now only be mentioned, that up till now about 1,700,000 litres 55% alkohol now about 1,700,000 litres 55% alkohol have been manufactured at the Skutskar mill.

In order to make the lye harmless several inventors have suggested to neutralize it with lime, let it settle, eliminating the SO<sub>2</sub> by vacuum, oxidizing the organic substances with air and chloride of iron, treatment with aldehydes in order to make the organic substances less soluble, etc. Most attention was obtained by the methods proposed by Frank and Dorenfeldt.

Frank precipitated part of the sulphur in the lye with lime in form of monosulphite, which was used for the acid preparing. Furnace gases and air were blown through the lye, saturated with lime, when the carbonic acid precipitated

\*—We will in a following number give a description of this method.

the lime and the air oxidized part of the organic substances. The lye became lighter colored, was afterwards run through screens and let out in the open to big drainage fields. Dorenfeldt evaporated and burned the lye after having added lime and soda (or black lye). The heat of combustion of the organic substances in the lye was utilized and the soda reclaimed.

Many machine concerns and inventors have contributed different suggestions for evaporation apparatus in order to solve the problem of concentrating the lye. The calorific value of the organic substances in the lye alone is, however, not sufficient for the evaporation.

The lye has further been used as a binding agent for briquettes of coal, lignite, charcoal, wood refuse, ore, etc., and for cement, mortar, sand for foundries, etc. None of these methods of utilizing the lye, however, has been largely used in the practise. The lye makes the briquettes hygroscopic and causes them to give off evil-smelling gases.

Knosel tried to utilize the lye as fertilizer. The evaporated lye was mixed with thomas slag and ground as thomas phosphate. The Knosel slag meal, however, was not worth the price.

Several American, German and Austrian patents have been taken out to prepare colors from sulphate waste lye.

Frank and others have proposed to prepare a fodder from the lye, with its contents of sugar as the main nutritive agent. Frank concentrated the lye, lime and formaline were added, the lye was filtered, again concentrated and mixed with molasses and peat powder. Stutzer eliminated the disagreeable taste with fatty oils. Goldschmidt precipitates the sugar and other substances containing hydroxyl compounds, and uses afterwards the benzoyl compounds obtained as food for animals.

Some ten inventors have proposed different methods to make tannine substances from the lye. Kupfmiller, for instance, precipitates the lime from the concentrated waste lye with soda. The filtrate is treated with muriatic acid, again concentrated, and mixed with Quebracho extract.

Mitscherlich suggested to separate by osmosis the colloidal substances in the lye, gum and tannine, from other organic substances and salts. Kempe boiled the lye under pressure, filtered, and boiled again under pressure with addition of heavy metal salts.

Mitscherlich and others tried to obtain glue from the lye. Mitscherlich precipitated the lye with animal glue. The tannine glue obtained was easily soluble in alkali and could for the sizing of paper be precipitated in the beating engine with acid or alum. The "tannine glue" however, was rather expensive, gave a dark color to the paper and could not effect a strong sizing. Klason suggested for mineral sizing of paper to precipitate silicic acid from silicate of soda with lye instead of alum.

Ekman added sulphate of magnesia to the concentrated lye. A white substance separated out on the surface and was skimmed off. The skimmed-off substance was dried and powdered. Ekman called this substance dextrone in order to make it understood that it could be used instead of dextrine, but the chemical composition was completely different. Cross and Beran obtained a substance, "gelalinosine," from the lye, which Ekman had treated with sulphate of magnesia, and which was similar to Mitscherlich's "tannine glue." It was insoluble in hot water, but soluble after addition of a little alkali.

Other substances, that have been prepared from sulphite waste lye, are: Acetone, succinic acid, coniferine, cymole, acetic acid, furfurole, rosin, rosin soap, hydrazone, laevulinic acid, merkaptane, methone, different liquid, carbo-hydrates, oxalic acid, pentoses, pyrocatechic acid, turpentine, vanilline, lubricants, etc. Consequently quite a number of valuable products. If no attention is given to the methods which only have scientific or historic interest, there however remain only some few which give products for which a sufficient market can be expected, always provided they can be executed economically. The cellulose chemist has here a certainly very difficult but possibly also remunerative field to work in.



## Jack Pine and Hemlock for Mechanical Pulp\*

*Concluded from last issue*

Figures 12, 13, and 14 show three photomicrographs of fibers obtained under exactly the same conditions of pressure, speed, and surface of stone. The tempera-

cent. hemlock. Fig. 13 shows hemlock fiber obtained under the same conditions (run 46b) as the first test, and figure 14 shows a number of spruce fibers (run No.

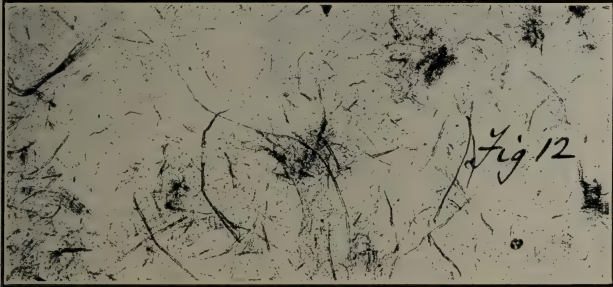

Fig. 12.—Ground-Wood Pulp, One-Third Spruce, Two-Thirds Hemlock. (Run No. 46A.)

ture and other minor variables were also kept as nearly alike as possible.

Fig. 12 shows fibers obtained by grinding hemlock in two of the grinder pockets and spruce in the third (run 46a). Upon

46c). The hemlock fiber is considerably shorter than the spruce and there are more shives present. In the composite sample the hemlock is decidedly in evidence.

Figures 15, 16, and 17 show three fibers

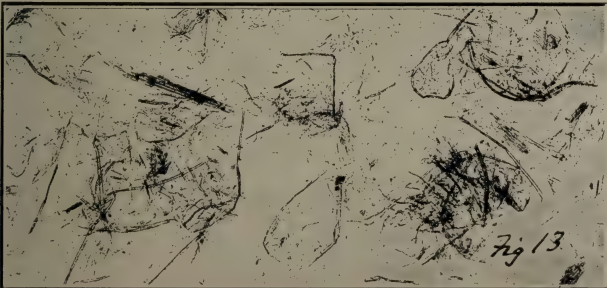

Fig. 13.—Ground-Wood Pulp, All Hemlock. (Run No. 46B.)

determination it was found that the pulp contained 34 per cent. spruce and 66 per

\*—Abstract of report by J. H. Thickens, Chemical Engineer in Forest Products, Forest Service, U. S. Dept. of Agriculture.

obtained by grinding different woods in different pockets of the pulp grinder. Commercial run No. 46a is composed of a mixture one-third spruce and two-thirds hemlock; commercial run No. 51 is composed of one-third jack pine, one-third spruce, and one-third hemlock; commercial run No. 52



of one-third jack pine and two-thirds hemlock. All of these pulps when in the lap appeared to be a very good quality; in fact, it will be seen that the fiber of which they are composed is of good length and that there is not nearly as much short

experimental pulps with the commercial standards shows that mixed pulps particularly compare well with the No. 4 standard, for which there is evidently the greatest demand.

In order to determine the adaptability

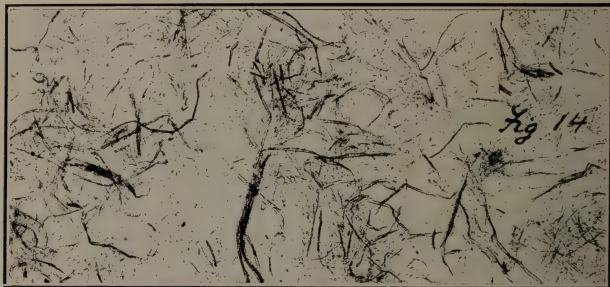

Fig. 14.—Ground-Wood Pulp, All Spruce. (Run No. 46C.)

material present as there is in the samples of hemlock pulp.

Commercially it would be possible to obtain better mixed pulps by grinding the different woods in separate grinders and preparing the stones so as to obtain the best quality of pulp from each wood.

of the pulps obtained in the experiments to the manufacture of paper, a number of test paper runs were made with the pulps which gave greatest promise. Samples of the paper obtained accompany the report. All of the sheets of news paper were made on a machine in the Port Edwards mill of

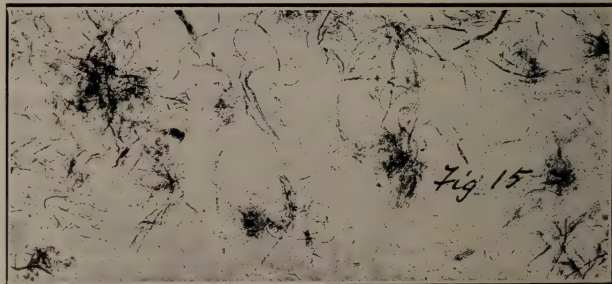

Fig. 15.—One-Third Spruce, Two-Thirds Hemlock. (Commercial Run No. 46A.)

It has been found, by comparing the samples submitted by American manufacturers with the standards chosen, that 5 per cent. can be classed as No. 1 pulp, 12 per cent. as No. 2 pulp, 12 per cent. as No. 3 pulp, 61 per cent. as No. 4, and 10 per cent. as No. 5. Comparison of the

the Nekoosa-Edwards Paper Co. This machine is 116 inches wide, and the sheet produced, trimmed, was 109 inches. The machine was operated at a speed of 465 feet per minute, and no changes were made in weight of sheet or speed after the beginning of the test; in fact, throughout

the runs the conditions were maintained as nearly constant as possible. The finish on the paper was obtained by passing the sheet nine times through a 12-roll calender stack. In each case three 1,500-pound

dandy, since it began to pick up stock. All of the papers were free on the wire and caused no trouble whatever.

The samples of paper containing spruce were made up for the purpose of com-

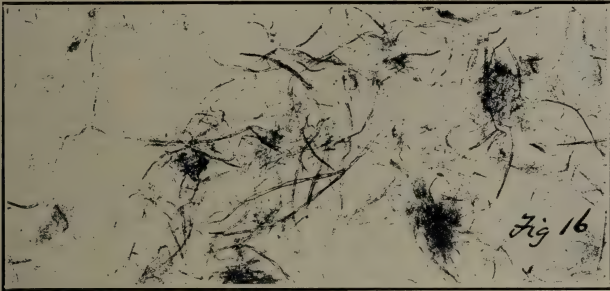

Fig 16.—One-Third Hemlock, One-Third Jack Pine, One-Third Spruce. (Commercial Run No. 51.)

beaters of stock were run into sheet in order to have the test continuous over sufficient time to give an idea of its operation on the paper machine. It was intended to by-pass the Jordan engine, but this being impossible, the stock was passed through the engine and the roll set up only slightly.

parison. It will be seen that, with the exception of color, the sheets differ little, and it is reasonable to suppose that the color could be improved. Allowance should be made for the appearance of the sheets as regards brown shives, these being due to the hemlock sulphite used, and not to the ground wood. Data on the beater

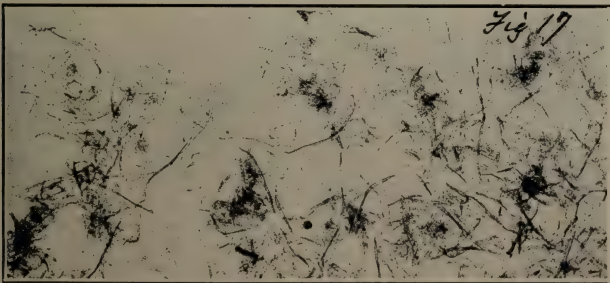

Fig. 17.—One-Third Jack Pine, Two-Thirds Hemlock. (Commercial Run No. 52.)

Running changes were made in each test, and no difference was found with any of the sheets excepting jack pine. This material was somewhat pitchy, and after an hour's run it was necessary to remove the

“furnish” for the various papers are given.

The samples of butchers' manila and No. 2 white manila given were made by the Nekoosa-Edwards Paper Co. These

samples are meant merely to give an idea of what can be obtained when mixtures of hemlock and spruce are used.

The strength of all of the sheets, with the exception of the one made up of hemlock sulphite and jack-pine ground wood, compares well with standard news paper. The paper from run No. 24 has another decidedly objectionable feature, and that is the loss of finish occasioned by rubbing the sheet with the hand. The fibers under this treatment fuzz up, and considerable powder and short fiber fall off. Several of the other sheets have this same peculiarity, but if more size were added this trouble would probably be eliminated.

The experimental papers have not yet been tested on high-speed presses, and this must be done before accurate knowledge of the value of the several sheets can be had.

However, after having obtained news paper of the quality of the attached samples from hemlock, jack pine, and mixtures of these woods without changing in any way present commercial practice, it seems beyond doubt that these woods may be advantageously used either singly or in various combinations, at least in the cheaper grades of paper.

Tables 4, 5, 6, 7, 8, and 9 show compilations of the data secured during tests on hemlock, jack pine, and mixtures of these two woods with spruce. The results of tests under many different conditions of speed, pressure, and surface of stone are given. In a number of cases the data on production and power consumption do not agree with that taken at another time and under the same conditions of pressure, speed, and type of burr. In all of these instances the differing values can be accounted for by the fact that although the same kind of burr was used, the stones were of different sharpness.

It has been found difficult to duplicate in one test the surface of stone used in another under the same conditions and obtain the same production with the same power consumption. In fact, the production factors vary greatly over short periods as a result of the varying attention given by the grinder man. On this account the power and production data in the tables can be applied to commercial

plants only approximately. If a grinder is operating under the conditions of any of the commercial tests shown in Tables 5, 6, and 7, however, the data given will closely approximate the actual working conditions.

---

#### LAURENTIDE PAPER CO.

At the annual meeting last month of the Laurentide Paper Co., held in Montreal, the financial report showed that the profits of the company's business for the year ended June 30th, 1912, after providing for interest and other charges, including an account of \$103,879.94 for betterments to the plant, were \$753,572.92. This compares with \$713,539.89 last year, or an increase of \$40,033.03.

The earnings were made up as follows:

From mills .....	\$910,846.14
From lumber and miscellaneous	98,705.49
	<hr/>
Total .....	\$1,009,551.63
Deduct betterments to plant ..	103,879.94
Bond interest and charges.....	152,098.78
	<hr/>
Net income .....	753,572.91

A surplus of \$193,572.91 was carried forward.

The following directors were re-elected: Sir William Van Horne, R. B. Angus, James Ross, Chas. R. Hosmer, Edwin Cahoon, jr., Frederick A. Sabbaton. At a subsequent meeting of the board Sir Wm. Van Horne was re-elected president, and George Cahoon, jr., vice-president.

---

#### CEMENT FOR PARAFFINED PAPER.

Soak good leather-glue for 24 hours in cold water. Pour off the unabsorbed water, and warm till liquid. Then add a little bichromate, and keep in the dark for use. This glue is very tenacious, and perfectly waterproof, when once it is set.

---

One of the features of recent sessions of the Toronto Stock Exchange is the rapid rise in value of the shares of the Toronto Paper Mfg. Co.

## Trade and Manufacturers' Notes

JEFFREY MFG. CO.

We have received from the Jeffrey Mfg. Co., Columbus, O., a copy of Bulletin No. 74, dealing with their freight and package handling machinery. It contains 134 different illustrations of mechanical equipments designed particularly for the economic handling of various materials. One equipment worthy of particular note is the Jeffrey improved type of finger tray elevators for raising and lowering packages, barrels, boxes, sacks, etc., also their swinging tray elevator platform carriers designed for a great number of uses. Also described are different types of arms and tray carriers, metal and wooden platform conveyors, rubber belt carriers, trippers, etc. The Jeffrey Mfg. Co. turn out an extraordinarily diversified line of products, every equipment being designed to meet some particular need and each one of which requires individual careful study as to details. For this purpose they maintain an engineering corps of over 200 sales and designing engineers at their main office in Columbus O., besides separate designing and engineering forces at the Montreal works besides those in their numerous branch offices in the United States and agencies throughout the world.

## H. FULLNER.

H. Fullner, Warmbrunn, Schlesien (Germany), the well-known engineers and manufacturers of paper machinery, have recently supplied machinery to the large Oker Company, Limited, print paper mill in Oker on Harz. It comprises one new rapid running newsprint machine with a total width of 127.95 in., with all complementary machines, and with the necessary grinders. The proprietors of the mill wired very soon as follows: "Machine started noon, paper immediately, good for use. Our compliments for your great success.—Eickoff & Kiel."

This makes the third wide paper machine supplied by H. Fullner this year. The widest was delivered to the Krappitz paper plant, and was 141.73 in. Another of the same size has been ordered by the Langed paper mill.

## H. R. MacMILLAN, CHIEF FORESTER FOR BRITISH COLUMBIA.

We have in a previous issue commented on the appointment of Mr. H. R. MacMillan to the important post of Chief Forester for the Province of British Columbia, the forest policy of which bids fair to stand forth as a glowing example for other provinces to follow. In the same connection the Canadian Forestry Journal says:—

"The Province of British Columbia is to be congratulated on having secured the services of so capable and energetic a forester as Mr. MacMillan. His connection with the Forestry Branch of the Department of the Interior dates back some years. In the first forest survey undertaken by the Branch, namely that of the Turtle Mountain forest reserve in the summer of 1905, Mr. MacMillan was chief of the party. He was then a student at the Ontario Agricultural College, from which he graduated in 1906, after a brilliant course, obtaining the degree of B. S. A. from the University of Toronto.

"In the fall of that year he entered the Yale University Forest School, graduating at the head of his class in 1908, with the degree of Master of Forestry. His vacations, in the meantime, had been spent in active forestry work, mostly with the Forestry Branch, and he then became a regular member of the staff. Since then he has been given a number of important and difficult assignments, both in field-work and in office-work, which have been completed with distinction. He entered with enthusiasm on the work of collecting statistics of the wood products of the Dominion and the work has become one of the most important parts of the Forestry Branch's work. The bulletins embodying the results of these investigations have also been compiled under his direction. He has also been the author of several other bulletins of the Branch, and has been prolific in magazine and newspaper articles on various forestry subjects."

The Canada Paper Co. are negotiating for the purchase of Utverton Falls, and propose to erect a five-foot dam for generating power.



## Effect of Fire in a Large Reinforced Concrete Paper Mill

On May 25th last, fire broke out at the pulp board mill of the Androscoggin Pulp Co., South Windham, Maine. The Aberthaw Construction Co. built this structure in 1906, I. W. Jones, of Milton, New Hampshire being the engineer. The building is of reinforced concrete excepting for a wooden roof carried on trusses of the same material. The window frames and sashes are also of wood.

The blaze started below the machine room floor in the main building and set fire to the wooden paneling between the piers forming the outside wall of the lower storey of the building. The burning panels

largely interesting test of the effect of fire on reinforced concrete work.

On May 26th, Norton C. Tuttle, secretary of the Aberthaw Construction Co., examined the building with Seth A. Moulton, of Portland, Maine, the engineer in charge of the rebuilding, and the latter made many shrewd suggestions as to the cause of some of the results observed. A few days later the engineer and superintendent of the Aberthaw Construction Co. made a careful investigation and report which is embodied herewith.

The fire started under the first floor in the middle of the building (Fig. 1).

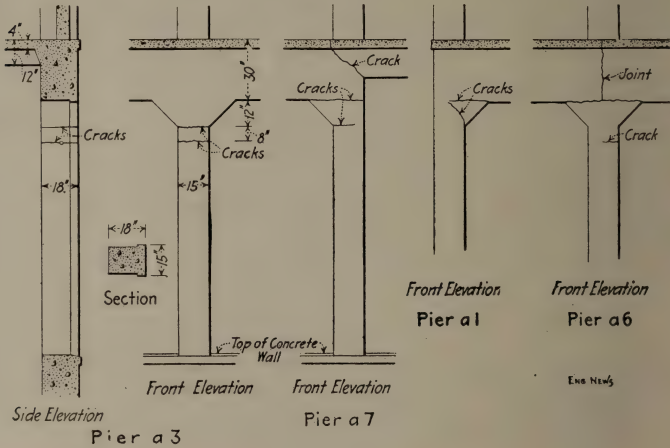

set fire to the wooden sash of the window of the second storey and from there set fire to the roof and to a wood and plaster gallery which was located along the side of the mill.

The fire was extremely hot, there being a large quantity of dry pulp board piled inside the building and which burned at the same time. The intensity of heat was so great that it bent and partly melted cast iron. Stream of water were partly melted at the hot surface with considerable force and altogether the fire offered a particu-

As far as could be observed the principal effect of the heat was to expand the floor causing a movement of the column. It was reported that on the morning of the 26th the end wall of the mill was observably out of plumb. At that time the concrete was generally so hot that one could not stand putting his hand on it outside of the building. Later on, this particular wall drew back again to the perpendicular. The crack at the pier, crack "A-7," (Fig. 2) shows the effect of this movement on the outside wall, where the





size of the wall beam changes due to different spacing of the columns. The cracks above and below the bracket of the column also seemed to indicate the longitudinal movement of the floor.

The cracking of the columns at the side of the building seemed to indicate the same sort of expansion. These cracks occurred at both top and bottom of some of the columns. The top cracks are shown in Fig. 2.

It will be noticed (Fig. 1), that in the section of the floor at the wall end of the building (right end), the main cracks run longitudinally and are clearly marked and that the cracks at right angles to the building are comparatively few.

Where the floor span decreases next to the large girders which support the paper machine the cracks begin to run at right angles, and end with diagonal cracks which die away into the part of the floor which was not heated. It is suggested that the cracks at the wall end of the building which are parallel to the main girder occurred because of the unequal heating of the big mass of this girder and the thinner floor slab, causing unequal expansion of the two masses. A similar cause may have produced the crack along the wall beam.

Because there was a considerable amount of water thrown upon light colored pulp and because the under side of the ceiling was blackened by the smoke from the fire, when the water carried the pulp through these cracks in the floor it showed these cracks very clearly on the under side. The cracking of the floor at the end of the paper machine foundation is shown on cross-section "C D" (Fig. 1).

At the end of the machine room, in the gallery, there was a stock house built with concrete piers, supporting a wooden floor carried on steel beams, with wooden columns carrying a wooden roof. The walls of the building were "hy-rib" metal. At the base of the building there were some brick walls, being in the condition shown in Fig. 6. The interesting feature of this particular building was that the foundation piers which were subjected to high heat were built of concrete, rich in mortar. This concrete withstood the action

of heat much better than did the granite concrete of the main mill.

The stone used in the concrete on this job was coarse grain crushed granite. The sand was of good quality and the work was carefully done. The placing of the steel was better done than on the average job.

#### FINDING PERCENTAGE OF GROUND WOOD.

No certain analytical methods for determining the amount of mechanical wood pulp contained in a paper have as yet been discovered. At present we must depend on obtaining a rough idea by means of color reactions and microscopic examination.

In estimating the depth of the red color given by the color re-agents for wood tissue (phloroglucinates, sulphate of aniline, Wurster's re-agent, i.e., dimethylparaphenylene diamine, and others), it must be remembered that thick papers give a deeper tint, all other things being equal, than thin papers, and that under the same circumstances, a heavily-loaded paper gives a lighter shade than a purer paper. So much is this the case that art papers must be freed from their size by brushing with warm dilute caustic soda before the test is applied. Furthermore, mechanical pulp from foliage woods does not give such a dark color with the re-agents as coniferous wood, and it must not be forgotten that in testing dyed paper the dye may interfere with the reaction color.

In such cases, it is useless to attempt to strip the paper, although that course of procedure has been recommended. The stripping re-agent is very likely to falsify the color test. The better course is to select a re-agent which will not interfere with the dye, or to rely solely on microscopic examination. If there is much dye in the paper, we are forced to depend entirely on the results obtained by the aid of the microscope.

As regards microscopic work, there are also precautions to be taken. Fibres may have been lost through the wire, so that the stuff from the suction-boxes also wants examination. The staining on the slide

## The Preparation of Fibre for the Paper Machine

BY ALEX. ANNANDALE

This process is, it is safe to say, the most important in the paper mill; as it is there that the fibres used, of whatever class, are so treated as to produce the best paper obtainable from them. Here also are attended to the very necessary and important points of sizing, loading, and tinting, or coloring.

It is an extraordinary thing, but the fact is that this undoubtedly most important process really does not get the attention it is entitled to, in one mill out of fifty, or possibly even a larger proportion.

Beating is a scientific process, and to be a good beaterman, a man requires to know how to treat each separate class of fibre he may be called upon to use, so that the very best results may be obtained from it.

It may be taken as an axiom that different fibres require different treatment. These treatments can only be ascertained by experience, and even with long experience, the greatest care and attention must always be exercised, or most certainly the best results will not be arrived at.

The average beaterman, we may safely state, works far too much by purely rule of thumb methods. He is told to treat a certain mixture of fibres for a certain quality of paper. He does so (generally without much thought about it), with the result that time after time when the paper machine starts up, the stuff is either very unsuitable for the required paper or at any rate not just right. Result, he has to make an alteration, and empty a long engine, or a fine engine, or a soft, or a free one, to improve what is already in the chest. Therefore, too often, quite a quantity of paper is run off at the commencement of a making, which is not what it should be, so quite likely the buyer may reject or demand an allowance on the whole making.

Surely a beaterman should know his business so well as to be able to prepare the material with the certainty that it is sent to the machine just as it should be.

Admitted that a good machineman can generally partly get over badly prepared stuff, the fact remains that he cannot properly remedy it. We, therefore, come back

to the old saying, "Good paper is made on the beaters."

A really first-class beaterman is about the most difficult man to find in the paper trade. Why should this be? Well, it is interesting work, but it just requires more thought and attention than the average man cares to give to it.

Again, in most cases, beatermen are paid at a lower rate than machinemen; also mill owners, as a rule, when selecting a foreman, generally engage a machineman.

The writer's experience is that a machineman generally can tell what sort of stuff he wants for a given paper. Whether his beaterman can, or will give him just what he wants, is a different question.

Granted that the machineman knows what he wants (a great point), but if he is taken up to the beaterhouse, in many cases he cannot tell what to do to get the required result. When a machineman becomes a foreman he very soon finds that he must make a study of beating, if he intends to have his paper right all the time. But it is rather late to begin then.

The writer is of opinion that under the foreman the beatermen should be the highest paid workmen in the mill. Machinemen, when they get rather elderly, and possibly rather stout for the machinehouse, might well be promoted to be beatermen, they could then apply the lessons they had learned at the machine, and after a few years on the beaters would make highly efficient foremen or superintendents.

Explained shortly, the object of beating is to reduce the fibre of whatever material is used, to the most suitable condition for making the class of paper that it is desired to produce. This may be done by various types of beating engines, of which by far the most common is the Hollander. This either does the work entirely, or is assisted by some type of refining engine.

The usual type of Hollander is, in its general idea, just the same as has been used for very many years. In detail there have been many improvements which need

not be specially mentioned as they are well known.

In form it is just a circulating trough, the circulation of which is caused by a revolving roll in which are arranged a number of steel knives which act as impellers of the fibre or pulp. This roll is arranged so that it can be raised or lowered at will, within its cover. Beneath this roll there is a plate which also contains steel knives.

The beating is done by the rubbing and cutting of the fibres between the revolving roll knives and the knives in the plate.

There have been many forms of beating engine invented, but the ordinary Hollander, and the Umpherston engine, are the most common in British mills. In the first the stuff travels round and round, and in the latter after passing under the roll it returns below the floor level and comes up again in front of the roll.

In many mills, especially those making fine quality papers, bronze knives, of a special quality, are used in the beater roll instead of steel. Without doubt these do make a more mellow stuff, and they are more cleanly. The first outlay for them is much more than for steel, but they last much longer, give a better result in the paper made, and when worn out command a much better price than steel.

In most high grade mills, at the present time, the preparation of the fibre is assisted after passing through the Hollander by a refiner. Of these, there are several in the market, such as the Jordan, the Marshall and Bertrams.

These refiners certainly help the beaters and give a finishing touch to the preparation of the fibres, so conducing to the improvement and greater regularity of the paper. It is quite erroneous to think that a refiner has yet been invented which will alone properly prepare any fibre.

It, however, must be conceded that for making news and such low qualities, that they so far beat and mix the fibres, that the resultant paper will run over the paper and printing machines. But certainly with a combination of Hollanders and refiner a better, stronger, and more lasting paper would be obtained.

If a papermaker wishes a strong paper,

he must be prepared to give time to the beating. Gently draw out and soften the fibres in such a way that each individual one gets nicely tapered at the ends. Then when these float on to the machine wire, they felt and splice themselves together, and make a nice even strong web.

The thinner the paper to be made, the more do the fibres require softening, and the longer do they require to be allowed to remain, and there being a smaller number of fibres in a thin sheet than in a thick one, each one ought to be so treated as to be in the very best condition for holding on to and interlacing with its neighbors.

In thick papers there are so many more fibres that a shorter time and less beating is generally sufficient.

There are many different fibres used in the manufacture of paper, and very generally several are mixed together in the beater and treated at the same time. This is very convenient, but it is not common-sense.

For example, suppose a certain paper has to be made of say, rags, sulphite pulp, and repulped paper. The rags should be beaten in a certain way, the sulphite pulp in another way, and the repulped paper, having already been beaten, should not want any more.

It is seldom possible in practice to beat each fibre separately and mix before making into paper, but there can be no doubt this would be the ideal way to work.

To overcome this difficulty, the obvious way is for the papermaker to do his utmost to make his standard qualities from such fibres as will best beat together.

The help of a good microscope for the purpose of a careful study of the appearance of different fibres, at intervals in the process of treatment, and of the finished paper made from them, is of very great assistance, as a guide to the best way to work them.

Naturally, as a matter of business, every papermaker desires to make the very best paper from the cheapest materials that can be persuaded to give the required result.

The writer's experience is that more progress can be made in this direction by careful and intelligent beating than can be made in any other department.



## Montreal Pulp and Paper Matters

(Special Correspondence Pulp & Paper Magazine.)

Montreal, Oct. 5, 1912.

There have been numerous developments in connection with the pulp and paper industry during the past month. The Wayagamack Pulp & Paper Company, of Three Rivers, commenced manufacturing a few days ago, bringing out as an initial output 25 tons a day. Later the company expect to start other units at work. Sir Rodolphe Forget, a director of this company, resigned from the board a short time ago owing, it is said, to difference of opinion with the other directors regarding the advisability of merging the Wayagamack Company with a number of other pulp and paper companies. It is said that he wished to bring about a merger of several pulp and paper companies while his co-directors were opposed to any such move.

The Eastern Canada Power & Pulp Company, whose bond interest fell due on the 1st of September, has still failed to pay up. Various rumors are afloat as to the reason of the non-payment of the bond interest, but it is generally believed that the company were unable to secure sufficient water and so could not operate to their capacity. It is said that the bond interest will be paid before the end of the year. The company have \$1,500,000 bonds issued and as the interest is paid half yearly there is some \$45,000 due at the present time.

An important paper company has just been incorporated with a capital of \$3,500,000 known as the Donnacona Paper Company, Limited, of which Mr. Geo. M. McKee, of Quebec, is managing director. The company have purchased the properties on the Jacques Cartier River owned by Mr. John Foreman, of Montreal, which consist of some 20,000 acres of freehold timber lands in the townships of Stoneham and Tewkesbury and 187 square miles of limits on the Jacques Cartier River watershed. They also purchased the property of the Baie St. Paul Lumber Company, consisting of sawmills, pulp wood plant, and 60,000 acres of pulp wood lands.

The Donnacona Paper Company will commence immediately the construction of a large plant at the mouth of the Jacques Cartier River for the manufacture of newsprint paper. Mr. McKee has had a corps of engineers on the site for the past two or three months making surveys and preliminary plans for the building of the plant.

The development for the immediate present will be a 50-ton paper mill, with water power development, ground wood mill and buildings large enough to increase the plant to 100 tons of paper next year.

New York, Utica and Syracuse capital is largely interested in the enterprise, together with several well known paper manufacturers from the States. Among them is Mr. C. H. P. Gould, president of the Gould Paper Company, Lyons Falls, N.Y., and president of the St. Regis Paper Company, Watertown, N.Y.

The officers will be: President, G. H. P. Gould; vice-president, Walter N. Kernan, New York, vice-president of the New York State Railways; treasurer, Chas. B. Rogers, president First National Bank, Utica, N.Y.

Something in the way of a "melon" is expected in connection with the Laurentide Pulp & Paper Company. This company's stock has been exceptionally active during the past year. As is known the company gave a stock bonus of 100 per cent. during the year and later increased the dividend from 6 to 8 per cent. Since a year ago the stock has advanced in market price over 105 points, and during the past few weeks has been actively traded in. It is expected that the company will develop 50,000 h.p. in connection with the falls at Grand Mere and sell this power to the Montreal Light, Heat & Power Company. It is said that the Laurentide Company will make a new issue of \$2,000,000 stock, giving the shareholders valuable "rights." The company has been doing remarkably well during the past few years.

The South Shore Power & Paper Company, recently organized with a capital



of \$2,000,000, propose to build a large paper and pulp mill at Drummondville, P. Q. The company have acquired several water power rights on the St. Francis River within a radius of ten miles of Drummondville, and have under consideration the question of developing 10,000 h.p.

There seems to be a considerable difference of opinion in this province regarding the policy the Dominion Government is likely to pursue in regard to pulp wood. An agitation was recently started among a section of the Canadian Manufacturers' Association seeking to have an export duty put on pulp wood. This it was claimed would compel American paper mills to locate their plants in Canada and manufacture here. This policy is being opposed by the farmers of the Province of Quebec who have been finding the selling of pulp wood a very profitable undertaking, since Sir Lomer Gouin's law prohibiting the exportation of pulp wood cut on Crown Lands went into force on September 1st, 1910. This prohibition shut off the big available supply of pulp wood and American manufacturers were forced to get their entire supply from privately owned land, which forced the price up 97c per cord. In 1910 this province exported 779,000 cords of raw pulp wood to the United States. Last year they exported but 636,000 cords. At the same time the consumption of pulp wood in this province increased by 47,000 cords. In other words the result of Sir Lomer Gouin's law was to decrease the exportation of raw pulp wood by 18 per cent. and to increase the home consumption by 14 per cent. It is believed here that Sir Lomer's law will gradually force American paper manufacturers to locate their mills in this province, and that it will not be necessary to resort to such a drastic measure as putting on an export duty on pulp wood. Last year there were incorporated in this province nineteen pulp, paper and lumber companies, with a total capitalization of \$41,709,000, and in addition one other pulp mill increased its capitalization by \$10,000,000. Quebec possesses 28 out of the 54 pulp and paper mills operating in the Dominion, and consumes over 58 per cent. of the pulp wood used in Canada. Last year three new mills com-

menced operations in the Province, while this year two or three have started and several are under construction. When it is considered that paper can be manufactured in this province for \$5.35 per ton cheaper than in the United States, and that this province possesses the raw material, the water power, and the labor necessary for the manufacture of paper, it is only reasonable to expect that in a short time American pulp and paper manufacturers will realize that it is to their best interests to locate here. At any rate there is quite a strong feeling among the farmers against any export duty being placed on pulp wood.

J. C. R.

J. R. Booth, of Ottawa, was recently elected a director of the Grand Trunk Pacific Railway.

\* \* \*

Welland D. Woodruff, of the Lincoln Paper Mills, and a former candidate for the House of Commons, has been appointed Deputy Provincial Game Warden for Ontario. His duties will extend not only over the local district, but over other parts of the Province. The appointment is generally commended by representative men of both political parties, though the duties will be largely of a nominal character.

#### FINDING PERCENTAGE OF GROUND WOOD.

Continued from Page 328.

needs careful doing, for the paper to be tested has to be compared with standard samples of known composition. Hence the same amount of the same stain must be used in both cases.

Too much reliance can, however, be placed on the effect of stains, and the real test is microscopic examination by an expert familiar with the appearances under magnification of the various fibres used in papermarking, and skilled in estimating the relative proportions between the vegetable ingredients of the paper, after perusal of, say, half a dozen slides. The usual stain is solution of iodine in zinc chloride. It dyes rag fibre red, chemical pure cellulose blue, and ligno-cellulose yellow or green.

## Pulp and Paper News

Paper makers should not lose sight of the opportunity presented by the growing favor in which bread wrappers are held.

\* \* \*

Work has ceased on Daniel Elliott's new paper board mill in the east end of Toronto, through the Harbor Board's notice that it will expropriate the site.

\* \* \*

The Cornwall Rossing Mill Co., which began the erection of a rossing mill in Cornwall, Ont., some time ago, are now completing the enterprise which it is hoped to have in operation some time this fall.

\* \* \*

The Howard Smith Paper Mills, Ltd., Montreal, have completed plans for the erection of a paper mill at Beauharnois, Que. There will be five storeys 165 x 80 ft., two storeys 200x66 ft., and two storeys 100x50 feet.

\* \* \*

The Canadian Pulp Mill Machinery Co., Montreal, will erect a factory for making a complete line of pulp mill machinery. A. R. Paull, who was president and manager of the Glen Falls (N.Y.) Machine Works, will be managing director.

\* \* \*

The Northumberland Paper and Electric Co.'s new beater room at Campbellford, Ont., is approaching completion. Five 1,500 lb. beaters, driven by individual motors, will be installed. About 40 tons (dry) of ground wood are being turned out daily.

\* \* \*

Wayagamaek Paper and Pulp Company is now on a producing basis. The mills were started about the middle of last month, the first unit being operated. This has a capacity of 25 tons of paper a day. Reports indicate that everything is working smoothly, and it is expected that the other units will shortly be put in operation.

\* \* \*

The Laurentide Paper Co. is removing its sales office from Grand Mere, Que., to Montreal, where it has taken an entire floor in the Canada Life Building. Mr. J. H. A. Acer, treasurer, is in charge. The great growth of the company's business, including large exports to various parts

of the world, is its reason for making the change.

\* \* \*

Contract for building plant for Donnacona Paper Co. on Jacques Cartier River has been given to Ambursen Hydraulic Co., of which G. R. Heckle, Montreal, is Canadian manager.

\* \* \*

The Eastern Canada Power & Pulp Company, a concern controlled by the Forget interests, did not meet the payment of its September bond interest, and the common stock, which was higher than 50 some months ago was offered away down. In some quarters, however, it is stated that an arrangement will be made shortly for the payment of the bond interest and that the company will not go into liquidation.

\* \* \*

Pulp-wood limits at Berimis, on the north shore of the St. Lawrence, near Rimouski, were successfully worked during the past season. Extensive logging operations were carried on, so that the product will probably be doubled next season. A new company, financed with American capital, has purchased the pulp-wood limits at Manicougan River, and extensive preparations are being made to exploit the property. There is a fall not far from the mouth of this river capable of furnishing about 350,000 horse-power, and this is to be utilized in connection with manufacturing the product of the forest.

\* \* \*

The Bishoprie Wallboard Co., of Cincinnati, O., is building a Canadian branch at Ridgemoor near Ottawa. The factory will be three storeys high, 50 feet by 132 feet. The main building being constructed of the company's wallboard, covered on the outside with a thick high grade cement plaster, thus giving a stucco effect. The Cincinnati plant of this company has doubled in size in the last two years. Ottawa presents many attractions on account of the facility of securing raw material there, and the extensive building operation going on in this territory insure the company a market for all their product at the start.

## Pulp and Paper Markets

Toronto, Oct. 5, 1912.

The paper mills as a rule have been working to capacity in all branches keeping pace with a very satisfactory demand. Prices remain much as they were since the upward lift in book and writings, and the undertone of business is steady. All indications seem satisfactory, pointing to a continuance of these conditions. There is still a heavy demand from the United States for newsprint paper and Ottawa district shipments are expected to total larger than ever before. The requirements for book papers are quite up to normal for the time of the year. Wrappings keep fairly steady.

Pulp mills are piling ground wood owing to the fine water supply on both sides of the line, and to the feeling that prices are going to keep firm.

Sulphite is still scarce and very strong.

---

### BRITISH MARKETS.

London, Sept. 23, 1912.

In mechanical pulp, while business transacted has not been very large, it seems to be becoming slowly stronger.

Chemical pulp is firm, but business is slow.

For foreign and domestic rags the demand is good and prices rule firm to higher.

The market for chemicals is firm, with an increasingly strong demand. Bleaching powder is reported strong, under heavy demand for export.

---

### SCANDINAVIAN MARKETS.

Manufacturers of pulp in Norway and Sweden anticipate an increased demand from America on account of the expansion of trade. High freight rates, however, are against this. There is a good market for high grades of sulphite and the greater proportion of next year's production is said to have been already contracted for. For mechanical the demand is only fair, with an upward tendency in prices.

In Finland a slight improvement in the demand for mechanical pulp is reported,

the over-production which some anticipated, not having materialized. Chemical pulp is quite firm.

---

### PULP AND PAPER MARKETS.

Montreal, Oct. 5, 1912.

Pulp and paper men in the province of Quebec are enthusiastic over the condition of the trade at the present time. News remains about the same as was quoted a month ago, or if anything, shows a gradual upward tendency. Sulphite is very firm, there being a shortage in bleached sulphite with a consequent firmer tone. Unbleached is also firm. Prices in fact are from 50 cents to \$1 higher than they were a year ago. The whole paper market is good with the exception of ground wood. Owing to the abundant water supply in the United States the mills have been able to grind their own and are fairly well stocked, with the result that Canadian ground wood is moving very freely. This condition of affairs is expected to last for another two or three months but will then show a change for the better. American importers of pulp wood have been in Montreal protesting against the increase in rates put in force by the railways. The Canadian roads have increased their rates about 1 cent per 100 lbs. which amounts to 35 to 40 cents per cord of pulp wood. The importers are protesting against the increase and point out that it is uncalled for. The railroads on the other hand contend that the increase in wages paid their employees and other overhead charges make it necessary for them to increase their rates. The increase is to take effect November 1st.

For the last two months the price of paper stock and paper mill rags, has been steadily advancing. The advance is more pronounced in the lower grades of waste paper and in rags for the roofing stock. Supplies of the latter are very limited and until the scarcity is relieved by shipments from Europe it is probable that prices will still further advance. There is a good demand for nearly all kinds of paper makers' stock and supplies are being closely bought up. We quote:

**EMERSON MANUFACTURING CO.**  
**LAWRENCE, MASS.**

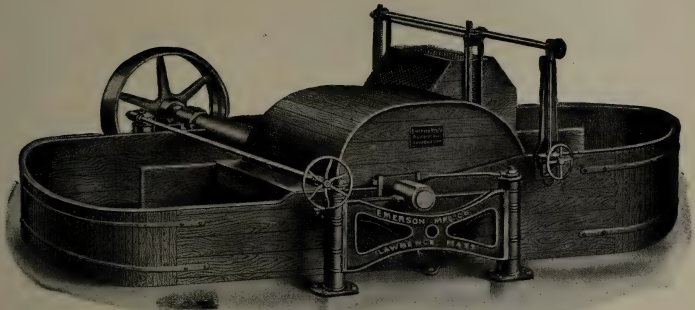

**Beating and Washing Engines**  
**Paper Mill Machinery**

**THE UNITED WIRE WORKS LTD,**  
**EDINBURGH, GLASGOW & NEWCASTLE-ON-TYNE**  
**FOURDRINIER WIRES, CYLINDER WIRES,**  
**AND WIRE CLOTH OF ALL KINDS.**

AGENTS, ARTHUR P. TIPPET & CO 8 PLACE ROYALE MONTREAL.  
WIRES HELD IN STOCK AT MONTREAL FOR PROMPT DELIVERY.

**ARTHUR P. TIPPET & CO.**

AGENTS AND IMPORTERS  
**PAPER MILL SUPPLIES**  
**SULPHUR FELTS**

**SAL AMMONIAC, BORAX, SANTITIE, ETC.**  
**MONTREAL, TORONTO.**



IMPROVED WARREN PATENT

# Double Drum Winder

With Slitter Attachment Combined

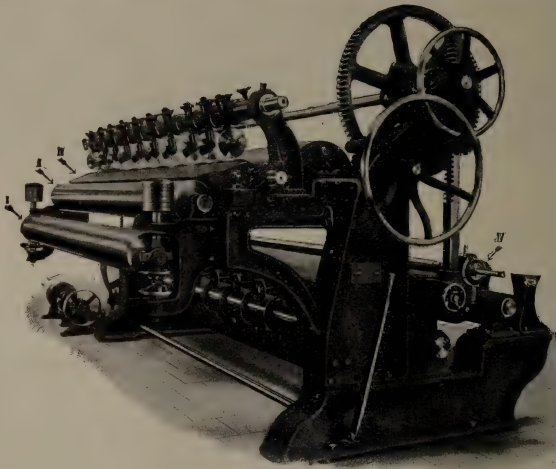

REAR VIEW SHOWING SLITTERS.

REFERENCE :

- I—8-inch Brass Spring Roll.
- II—8-inch Brass Carry Roll
- III—8-inch Adjustable Draw Board.
- IV—Adjustable Core Shaft Box.

Compare this Winder with Others

BUILT BY

## Ticonderoga Machine Works

TICONDEROGA, N.Y., U.S.A.



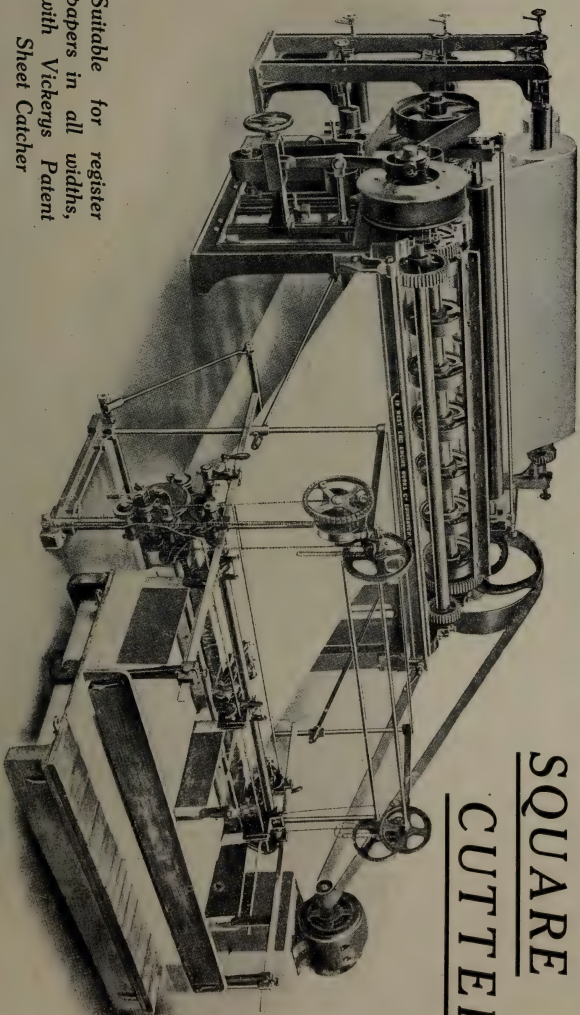

# SQUARE CUTTER

Suitable for register  
papers in all widths,  
with Vickerys Patent  
Sheet Catcher

MADE BY

THE WEST END ENGINE WORKS CO.

PAPER MAKERS' ENGINEERS

EDINBURGH  
SCOTLAND

Waste Paper, f.o.b. Montreal.  
 No. 1 Hard Shavings, \$1.65 to \$1.75.  
 No. 1 Soft white Shavings, \$1.60.  
 No. 2 Soft White Shavings, \$1.15.  
 Mixed Shavings, .45c.  
 White Blanks, 80c.  
 Ledger, \$1.10.  
 No. 1 Book Stock, 75c. to 80c.  
 No. 2 Book Stock, 35c. to 40c.  
 Manilla Envelope Cuttings, \$1.00.  
 White Envelope Cuttings \$1.75.  
 No. 1 Print Manillas 55c.  
 Railway Manillas 50c.  
 Folded News, 45c.  
 Crushed News, 40c.  
 Good mixed Paper, 35c.  
 Rags, Old and New, per 100 lbs., f.o.b.  
 Montreal—  
 Old White Cotton, \$2.50.  
 Mixed Cottons, \$1.40 to \$1.50.  
 Light Cottons, \$1.50 to \$1.60.  
 No. 1 White Shirts Cuttings, \$5.00 to \$5.50.  
 Light Print Cuttings, \$4.00 to \$4.50.  
 Fancy Shirt Cuttings, \$1.75 to \$2.00.  
 Blue Overall Cuttings, \$3.40 to \$3.50.  
 Brown Overall Cuttings, \$2.25 to \$2.50.  
 Black Overall Cuttings, \$1.65 to \$1.70.  
 Linings, \$1.60 to \$1.75.  
 New Unbleached Cotton, \$4.50 to \$5.00.  
 Bleached & Unbleached Shoe Clips, \$4.00  
 to \$4.25.  
 New Light Flannelettes, \$3.75 to \$4.00.  
 Flock Satinets Roofing Stock, 80c. to 90c.  
 Ordinary Satinets, 60c. to 65c.  
 Tailors Sweepings, 60c. to 65c.

#### CONSTITUENTS OF SPRUCE, ETC.

The study of the extremely complex question of the nature and constitution of the woody substance of the coniferous woods has been considerably advanced in the last two or three years by the researches of Professor Klason, of Stockholm. In 1911 he published a brochure, setting forth the results obtained from his investigation of the by-products of the manufacture of sulphite

woodpulp. According to Klason, dry spruce wood contains about 10 per cent. of wood gum, yielding on hydrolysis 25 per cent. of pentose, and about 28 per cent. of lignin, which, however, is not in chemical combination with the cellulose and other carbohydrates. Lignin is a colloid having apparently a very high molecular weight; it is a mixture of at least two main constituents differing in their proportions of methoxyl groups. These constituents have been formulated by Klason as  $C_{46}H_{42}O_{31}$  and  $C_{69}H_{46}O_{42}$ .

In connection with the sulphite process, Klason has put forward the hypothesis that lignin may be regarded as a condensation product of coniferyl and hydroxy-coniferyl alcohols, in which four molecules are condensed together with the elimination of  $3H_2O$ . This hypothesis certainly gives a simple and apparently a sufficiently complete working picture of the reactions which take place in the sulphite process of digestion of wood, but it has not been sufficiently developed in its general relations to other reactions to be accepted as a final solution of the constitution of the lignin molecule.

Attacking the problem in another direction, likewise in connection with the great Swedish national industry, he has also studied the by-products of the manufacture of wood cellulose by the sulphate process. In this process the wood is digested with a lye containing as active ingredients sodium hydroxide and sodium sulphide, together with sodium sulphate as a restraining agent. The subject was approached by Klason, first from the point of view of the recovery of volatile by-products: oil of turpentine and methyl alcohol. The methyl alcohol is derived from the methoxyl groups of the lignin, and part of it combines by a secondary reaction with the sulphur in the lye, procuring methyl mercaptan and methyl disulphide, which are the cause of the abominable odor connected with this branch of the industry.

To be Continued Next Issue.

## The PULP & PAPER TRADING CO.

TEMPLE COURT BUILDING, NEW YORK CITY.  
 DEALERS IN

# Paper and Pulp of All Kinds.

Prices and Samples on Application.

Telephone: 2726 BROAD.

Cable Address: "LAGERLOF NEWYORK."

# Scandinavian-American Trading Company,

PRODUCE EXCHANGE BUILDING, NEW YORK,

IMPORTERS AND EXPORTERS OF

FOREIGN AND DOMESTIC

# WOOD PULP

OF ALL KINDS

AND

# PAPER MILL SUPPLIES.

HANS LAGERLÖF, PRES.

ALL KINDS OF  
Machines for Paper, Pasteboard,  
Cardboard, Cellulose  
and Pulp Mills

Paper Machines      Calenders  
Winders      Calender Roll Lathes  
Filters (Füllner's Construction)  
Cutters      Cone Refiners  
High Power Grinders      Patent Beaters  
Edge Runners

FIRST-CLASS REFERENCES

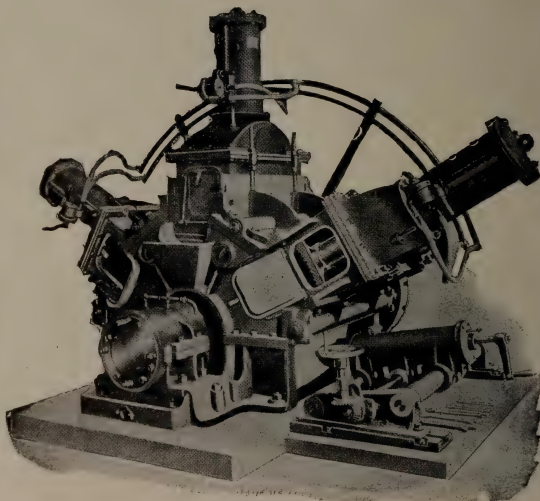

MOST MODERN CONSTRUCTIONS

Founded 1854

**H. FÜLLNER**

WARMBRUNN  
SILESIA  
GERMANY

Prizes won at all exhibitions where machines have been shown.  
Turin 1911 "Grand Prize." Paris 1900 "Grand Prix" und "Kreuz der  
Ehrenlegion." Leipzig 1897 "Gold Medaille." Paris 1907 "Grand Prix."



# CLASSIFIED ADVERTISERS' INDEX

If you fail to find what you want in these columns, write us and the desired information will be gladly supplied

## Architects and Engineers

Ambrusen Hydraulic Con.  
Co.  
T. Linsey Crossley  
J. A. DeCew  
Eaton & Brownell  
Geo. F. Hardy  
Herbert S. Kimball  
International Process Co.  
Arthur D. Little, Inc.  
R. S. Lea & H. S. Ferguson  
Lyford, Clark & Lyford  
H. B. Prather  
Chas. B. Pride  
T. Pringle & Son  
Stebbins Eng. & Mfg. Co.  
R. O. and W. G. Sweezey  
Jos. H. Wallace & Co.

## Barkers.

Carthage Machine Co.  
Green Bay Barker Co.  
Jenckes Mach. Co.  
Waterous Engine Works.

## Beaters.

Dillon Mach. Co.  
Emerson Mfg. Co.  
H. Fullner  
Holyoke Mach. Co.  
E. D. Jones & Sons Co.  
Valley Iron Works  
Waterous Engine Works

## Beater Rolls.

J. A. DeCew  
J. Marx & Co.

## Belting.

Dom. Belting Co.  
F. Reddaway & Co.  
Sadler & Haworth

## Bleaching Powders.

Brunner, Mond & Co.  
Hooker Electro-Chemical  
Co.  
Winn & Holland

## Boilers.

Jenckes Machine Co.  
John McDougall Caledonian  
Iron Works

## Brass Wire Cloth, Fourdrinier Wires.

Geo. Christie, Ltd.  
Herman Finckh  
C. H. Johnson & Sons,  
Ltd.  
Jas. Taylor  
A. P. Tippet & Co.  
United Wire Works  
P. P. Westbye

## Camel Hair Belting.

F. Reddaway & Co.

## Calender Rolls.

Farrel Foundry & Mach.  
Co.

## Chemicals, Colors, Etc.

Brunner, Mond & Co.  
Gewerkschaft Sachtleben  
A. Klipstein & Co.  
Hooker Electrochemical  
Co.  
Paper Makers' Chemical  
Co.  
A. P. Tippet & Co.  
United Alkali Co.  
Wilson-Paterson Co.  
Winn & Holland

## China Clay.

China Clay Co.  
A. Klipstein & Co.  
C. A. Meincke & Co.  
Paper Makers' Chem. Co.  
Wilson-Paterson Co.

## Chippers.

Carthage Machine Co.  
Jenckes Machine Co.

## Conveying Machinery.

H. W. Caldwell & Son Co.  
M. Garland Co.  
Jeffrey Mfg. Co.

## Digester Lining.

Panzl Digester Lining Co.  
Preston's Digester Lining  
Co.  
Stebbins Eng. & Mfg. Co.

## Digesters.

Schaeffer & Budenberg  
Mfg. Co.  
Swenson Evaporator Co.

## Drainer Bottoms.

Samuel Snell Co.

## Evaporators.

Ernest Scott & Co.  
Swenson Evaporator Co.  
Zaremba Company.

## Exporters.

Parsons Trading Co.

## Felts.

F. Bredt & Co.  
Dallyn, Jardine & Co.  
Hamelin & Ayers Co.  
C. H. Johnson & Sons,  
Ltd.  
Penman's, Ltd.  
Joseph Porritt & Sons.  
J. H. Spencer & Sons.  
A. P. Tippet & Co.

## Fourdriniers Wires.

(See Brass Wire Cloth.)

## Grinders.

Carthage Machine Co.  
H. Fullner.  
Glens Falls Mach. Co.

Holyoke Machine Co.  
Jenckes Machine Co.  
J. M. Voith  
Waterous Engine Works

## Knives.

Crookes, Roberts & Co.  
Peter Hay Knife Co.  
A. P. Tippet & Co.

## Lamps.

Gustaf Fornstedt.

## Paper Mills.

Canada Coating Mills.  
Canada Paper Co.  
New Brunswick P. & P.  
Co.  
Rolland Paper Co.  
Riordon Paper Co.

## Paper Presses.

Can. Boomer & Boschert  
Press Co.  
Jenckes Machine Co.

## Paper and Pulp Dealers.

Atterbury Bros.  
Albert E. Mallandain.  
Castle, Gotthell & Over-  
ton  
Churchill & Sim  
Howell Co.  
Parsons Trading Co.  
Pulp and Paper Trading  
Co.

## Paper Stock, Rags, Etc.

Atterbury Bros., Inc.  
J. Christie Co.  
R. Hough  
The Howell Co.  
E. Pullan  
J. R. Walker & Co.

## Paper and Pulp Mill Machinery.

Appleton Machine Co.  
Beloit Iron Works  
Bentley & Jackson  
James Bertram & Son,  
Ltd.  
Bertram's, Limited  
The Black-Clawson Co.  
Canadian Boving Co.  
Carthage Machine Co.  
Chambers & Simpson  
Dillon Machine Co.  
Emerson Mfg. Co.  
Farrel Foundry & Ma-  
chinery Co.  
H. Fullner.  
Julius Fischer  
Glens Falls Machine Wks.  
Green Bay Barker Co.  
Harmon Machine Co.  
J. H. Horne & Sons Co.  
Holyoke Machine Co.  
Jenckes Machine Co.  
E. D. Jones & Sons Co.  
C. H. Johnson & Sons,  
Ltd.  
Marx, J. & Co.  
Jas. Milne & Sons  
Moore & White Co.



B. F. Perkins & Son  
Rice, Barton & Fales  
Ryther & Pringle  
Sandy Hill Iron & Brass  
Works

Ernest Scott & Co.  
Sheldons, Ltd.  
Sherbrooke Machinery  
Co., Ltd.

S. Morgan Smith Co.  
Stebbins Engineering &  
Mfg. Co.

H. F. Storrer  
Swenson Evaporator Co.  
Ticonderoga Machine  
Works

Valley Iron Works  
J. M. Voith  
Charles Walmsley & Co.  
Chr. Wandel

Wandel Screen Mfg. Co.  
Waterous Engine Works  
Co., Ltd.

P. P. Westbye  
West End Engine Wks. Co  
Zarembo Co.

**Pipes (Wooden).**

National Pipe & Foundry  
Co., Ltd.

**Pulp Stones.**

Stancliffe Estates Co.  
Ltd.

**Pumps.**

Can. Boving Co.  
Carthage Machine Co.  
Dillon Machine Co.  
Lawrence Machine Co.

Lawrence Pump & En-  
gine Co.  
John McDougall Caledon-  
ian Iron Works.  
Smart-Turner Mach. Co.

**Rosin Size.**

Paper Makers Chemical  
Co.  
Vera Chemical Co.  
Wilson-Paterson Co.

**Scales.**

Alfred H. Mardon

**Screen Plates.**

Union Screen Plate Co. of  
Canada

**Screens.**

Glen Falls Machine Wks.  
Harmon Machine Co.  
Jenckes Machine Co.  
Sherbrooke Machinery Co.  
J. M. Voith.  
Chr. Wandel  
Wandel Screen Mfg. Co.  
Waterous Engine Works  
P. P. Westbye

**Slitters and Re-Winders.**

H. Fullner  
Moore & White Co.  
Ticonderoga Mach. Co.

**Sulphur.**

Union Sulphur Co.

**Talc.**

Geo. H. Gillespie Co.

**Tanks.**

Jenckes Machine Co.  
John McDougall Caledon-  
ian Iron Works

**Transmission Machinery.**

H. W. Caldwell & Son Co.  
Jones & Glassco  
Dodge Manufacturing Co.

**Travelling Cranes.**

Hugh R. Blethen  
Northern Crane Co.  
Smart-Turner Mach. Co.

**Turbines.**

J. M. Voith  
S. Morgan Smith Co.

**Water Wheels.**

Jenckes Machine Co.  
John McDougall Caledon-  
ian Iron Works  
Holyoke Machine Co.

**Wire Cloth for Paper Ma-  
chines.**

Scottish Wire Cloth Co.,  
Ltd.

**Wood Pulp Agents.**

Castle, Gottheil & Over-  
ton  
Churchill & Sim  
Parsons Trading Co.  
Scandinavian Amer. Trad-  
ing Co.

# Gears



CUT TEETH OR  
MACHINE MOLDED  
Spur - Bevel - Mitre  
MORTISE WHEELS

Write for prices. Send for Catalog 34

H. W. Caldwell & Son Co.

CHICAGO : 17th St. and Western Ave.

NEW YORK : Fulton Building, 50 Church Street

# J. H. Horne & Sons

COMPANY

Lawrence - - - Mass.

---

---

MANUFACTURERS OF

## PAPER MILL MACHINERY

---

---

Fourdriniers  
Cylinders and  
Wet Machines  
Improved Horne Engines

Horne Jordan Engines  
Double Bevelled Roll Bars  
Horne Friction Cullers  
Barbed Jordan Bars

SEND FOR CATALOGUE

## THE PERKINS PAPER MILL MACHINE ROOM VENTILATING SYSTEM

*Will properly ventilate your Machine Room and positively prevent all condensation and dripping from the ceiling even on the coldest day of a Canadian Winter. Write for further particulars and list of enthusiastic users.*

---

USED IN LEADING MILLS ALL OVER  
THE COUNTRY.

**B. F. PERKINS & SON, Inc.**  
HOLYOKE, MASS., U.S.A.

**FROZEN PULP AND DRY PULP  
IN A**

## Ryther Shredder

Is shredded at the rate of 5 tons per hour.  
17 to 25 H. P. required. The above figures are  
*dry weight* and absolutely guaranteed.

RELIEVE YOUR BEATERS and INCREASE QUALITY  
and PRODUCTION. Write for full Particulars.

---

**Ryther & Pringle Company**  
Carthage, N.Y.

# WORTHINGTON PUMPS

*SPECIALLY DESIGNED TO MEET  
THE CONDITIONS OF*

**PULP and PAPER MILLS**

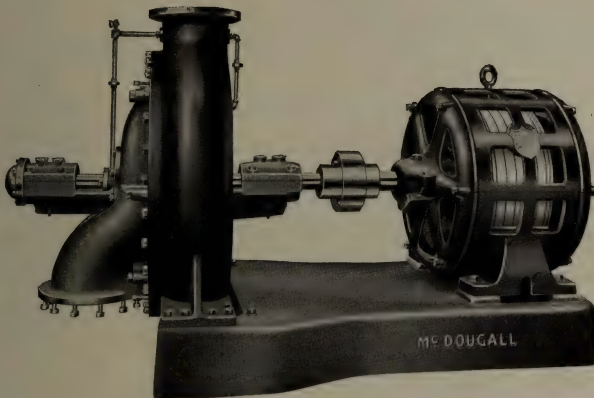

Turbine Pump, capacity 4,000 U.S. gals. per min.  
for Water Supply

*SEE BULLETIN 108*

**THE JOHN McDOUGALL  
Caledonian Iron Works Co.  
LIMITED**

**WORKS, WILLIAM AND SEIGNEURS STS. - MONTREAL**

*PRESTON'S*

# Lining for Sulphite Digesters

TOTAL THICKNESS ONLY 2% TO 2% INCHES

Resists the action of the acid and ensures absolute protection to the Digester Plates.

Great durability, therefore large saving in upkeep and repairs.

Larger internal space and increased production on account of the small thickness occupied.

Extensively adopted by Scandinavian and Continental Mills.

Over 200 Digester Linings in work and on order.

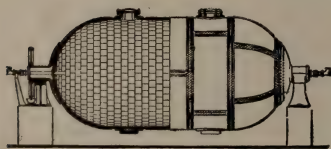
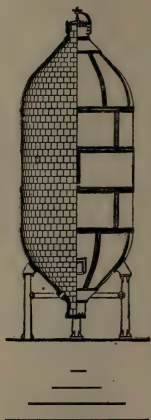

Telegraphic Address :

**"PRESTONS, RADCLIFFE."**

CODE USED A. B. C., 4TH & 5TH EDITION.

*Full Particulars and Prices on application to SOLE MANUFACTURERS*

## PRESTON'S DIGESTER LINING CO., LIMITED

RADCLIFFE, near Manchester, Eng.



---

---

FARREL FOUNDRY AND MACHINE  
COMPANY

ANSONIA, CONN., - - - U. S. A.

Largest Manufacturers in the world of

**CHILLED ROLLS**

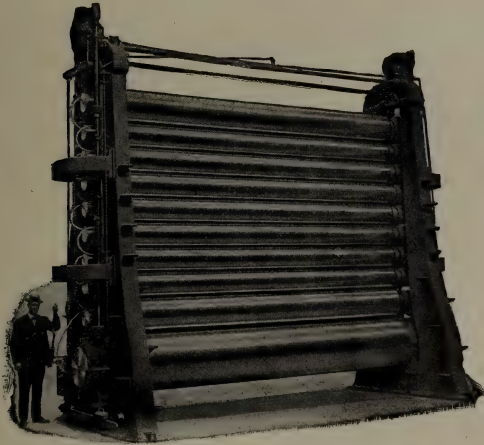

**CALENDERS**

*WITH PATENT HYDRAULIC LIFT*

**ROLL GRINDING MACHINES**

---

---

*Would YOU like to enlarge your Business and find new Customers in all parts of the world? If so, ADVERTISE in*

# “THE PAPER-MAKER AND BRITISH PAPER TRADE JOURNAL.”

THE LEADING AND MOST POPULAR TRADE ORGAN.

**THE ADVERTISER IS GOOD FOR THE READER**

We recently received the following letter:—

“We have hesitated over the matter, as we are at present so busy as to regard further advertising as almost superfluous.

“On the whole, however, we find it pays us better to have to refuse orders than to hunt after them, and will ask you therefore to insert our advertisement on same terms as last.

“We enclose herewith amended matter for advertisement, and shall be glad to have proof of same at your early convenience.”

We are constantly in the receipt of gratifying letters relative to the usefulness of our Journal, and we have pleasure in printing the following:

“Gentlemen,

We beg to advise that we have not as yet received the June number of ‘THE PAPER-MAKER AND BRITISH PAPER TRADE JOURNAL.’

We like the publication so well that we should be very sorry indeed to miss a copy of it.

Thanking you in advance for your kind attention,

We are, dear Sirs, yours very truly,  
F. R. KEYES & SON.  
20 Broad Street, New York.”

## S. C. PHILLIPS & Co.'s STANDARD PUBLICATIONS

### The Paper-Maker

AND BRITISH PAPER TRADE JOURNAL.

Published on the 1st of each month. Price 1s., by post 1s. 6d. Annual Subscription 12s. 6d. post free.

### The Stationery World, Printing and Allied Trades,

AND FANCY GOODS REVIEW.

Published on the 25th of each month. Price 6d. by post 7d. Annual Subscription 5s. post free.

Chief Offices:

47 CANNON STREET, LONDON, E.C. (ENGLAND).

### The Paper Box and Bag Maker.

Published on the 19th of each month. Price 6d., by post 7d. Annual Subscription 6s. 6d. post free.

### Phillips' Paper Trade Directory of the World.

15s. 6d., post free to all countries.

NEW EDITION FOR 1911 NOW READY.

Specimen Copies and Advertisement Rates  
FREE OF APPLICATION.

# PAPER and CLOTH Specialties

*For Rent and Club Cards, Pattern Cards, Map Printing, Label Printing, Envelopes, etc., etc.*

Cloth Lined Papers. Cloth Centred Papers and Boards. Cloth Lined, Chromo and Enamel. Cloth Lined Boards and Cards (surfaced and enamelled). Cloth Centred Boards (surfaced and enamelled). Manilla Surfaced Boards and Cards.

**Also Enamelled Blotting. Art Papers. Paste Boards. Chromo and Surface Papers**

Customers' requirements in specialties are carefully considered and experiments conducted if necessary.

---

## ALBERT E. MALLANDAIN

OFFICES: 51 Cheapside  
London, E.C.

MANUFACTURER

MILLS: Park Royal  
Willesden, London, N.W.

## E. H. WILKINSON

Telephone Building  
82 Adelaide Street West  
Toronto

*Sole Agent for Canada*

Telephone Main 1716  
Cable Address: *Faultless*

# HERMANN FINCKH

REUTLINGEN

*Established 1879*

GERMANY

---

# FOURDRINIER WIRES

---

**SULPHITE - MACHINE WIRES**  
**CYLINDER WIRES**

---

**P. P. WESTBYE, - Peterborough, Ontario**

*Sole Agent for Canada*

## WANT AND FOR SALE ADVERTISEMENTS

**MANAGER'S ASSISTANT** wants position—Groundwood pulp, fast-running news, writing, wrapping, kraftpaper. Apply Box 37, Pulp and Paper Magazine.

**ENGINEER**—With head office in St. John, N.B., would like to correspond with responsible firm of pulp and paper machinery manufacturers wishing to open business in the Maritime Provinces. Apply "Reliable," c/o Pulp and Paper Magazine.

**AGENT WANTED** to represent in Canada an old established firm of English Felt Makers. Only reliable firms calling personally and periodically on Paper Mills need apply. Box 811, c-o The Paper Maker, 47 Cannon Street, London, E. C., England.

**PRODUCTION ENGINEER:** Mechanical and consulting, sulphite and paper mill expert, 31 years of age, first-class designer and pulp chemist, wants only well paid position in Canada or United States. Apply Box 34, Pulp and Paper Magazine.

**UNDER MANAGER.**—Young man, 14 years' practical experience in English mill making long elephants, news, all-wood printings, cream laid, etc. Experienced mill chemist—testing of papers, fibres, etc. Highest references. Address H. C., c/o Pulp and Paper Magazine.

**WANTED IMMEDIATELY.**—Master mechanic, machinists, millwrights, and pipefitters for Canadian soda, pulp and paper mill now under construction. Only experienced men need apply. State wage and give references. Apply Box D, Pulp and Paper Magazine.

**FOR SALE.**—Special Second-hand cylinder mould, 48-in., diameter 84-in. face. Good as new. Can be used as Filter. For particulars, etc., address Box 32, Pulp and Paper Magazine.

**SUPERINTENDENT** for sulphite pulp—Mitscherlich, Ritter Kellner and combinations, tower and tank acid systems, European and American experience. Open for engagement. Apply Box 36, Pulp and Paper Magazine.

**MECHANICAL AND MILL ENGINEER**—University education, wood pulp, fibre, paper, cardboard specialist wants new engagement. Rebuilding, management, money saving improvements. Apply Box 38, Pulp and Paper Magazine.

**ENGINEER**—English, 38, with exceptional experience in the paper trade, is open for an appointment. Fully qualified, civil and mechanical training and practice. 22 years with two (only) of the largest paper makers in the country. Well up on fuel, engines, boilers, and electrical plant, and driving. Conversant with the latest paper mill methods and machinery. Can design, build, and operate a works for any output. Had very extensive experience in building and railway work, bridges, and reinforced concrete. Good organizer and disciplinarian. Apply Box 35, Pulp and Paper Magazine.

**PULP MILL CHEMIST** with twelve years' experience in Sulphite (Bleached and Unbleached), wants similar position, good draughtsman. Apply Box 30, Pulp and Paper Magazine.

As we are using all our Water Power at our Pulp Mill for electricity, we are disposing of the Pulp Mill Machinery—including Millard Patent Grinders which were in use only a few months and are absolutely as good as new, also Wet Machines, Barkers, Screens, Pumps, Piping, Shafting, Stones, etc., etc., all in good condition. Full information will be given upon application.

Apply Box 'A,'

Pulp and Paper Magazine.

SCOTT'S IMPROVED RECOVERY SYSTEMS  
 FOR  
**SODA, SULPHATE & SULPHITE**

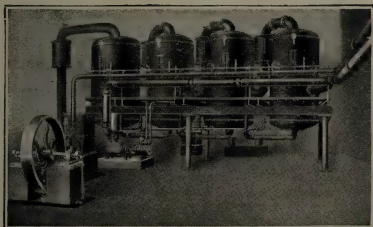

Spent Liquors give the  
**MAXIMUM ECONOMY**  
**AND EFFICIENCY**

The PRINCIPLE,  
 The DESIGN,  
 The CONSTRUCTION,  
 The OPERATION,  
 The RESULT,

**Is RIGHT**

Complete installations made by "THE FIRM WITH THE EXPERIENCE."

**ERNEST SCOTT & CO.** Manufacturing  
 Engineers

FALL RIVER, MASS. and MONTREAL, P.Q.

SODA or SULPHATE  
**LAP-WELDED**  
**DIGESTERS**

Swenson Multiple Effect Black Liquor Evaporators.  
 Rotary Black Ash Incinerating Furnaces.  
 Complete Soda Recovery Equipment.

**SWENSON EVAPORATOR CO.**

945 MONADNOCK BLDG., CHICAGO



# SHELDON

## HEATING APPLIANCES

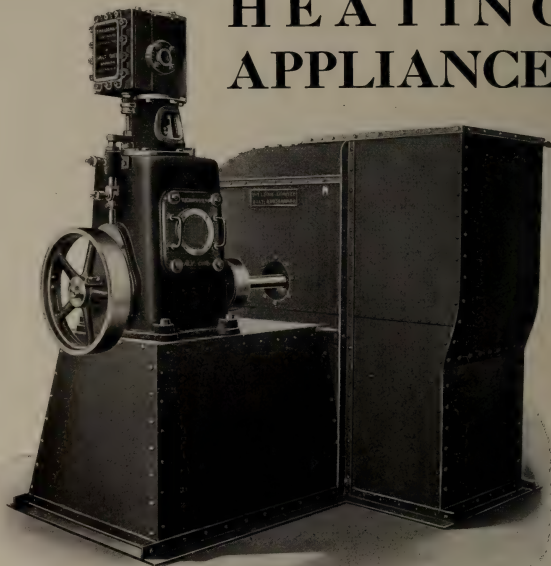

Fan, with Vertical Enclosed, Forced Lubricating Engine, for  
Textile, and Pulp and Paper Mills.  
Heating and Ventilating, Callander Blowers, Piping, etc.

---

**SHELDONS LIMITED**  
GALT - - - ONTARIO

Toronto Office: 609 Kent Bldg.

Agents: Ross & Greig, 412 St. James St., Montreal, Que.

Grose & Walker, 259 Stanley St., Winnipeg, Man.

R. Hamilton & Co., Bank of Ottawa Bldg., Vancouver, B.C.

VALLEY IRON



WORKS COMPANY

# BEATING AND WASHING ENGINES

IRON OR WOOD TUBS

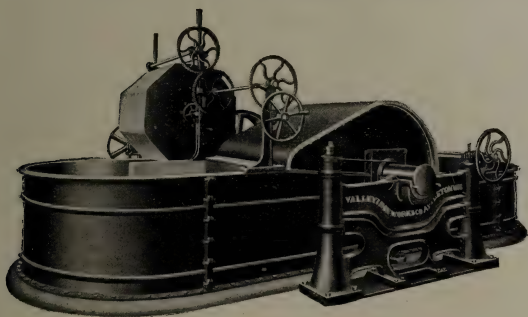

*Perfection in Every Detail*

Beating, Washing and Bleaching Engines. Barkers—Barker Attachments—  
—Chippers—Rechippers—Chip Screens (Revolving)—  
Knot Screen (Revolving)—Diaphragm Screens—Felt Washers—Deckers  
(Single and Double)—Stuff Chests (Vertical and Horizontal)—  
Tanks (Blow Off, Acid and Water)—Pulpwood Saws (Friction and  
Steam Feed)—Pulpwood Splitters (Vertical and Horizontal)—  
Shredders and Special Washers for old Paper Stock—Wet Machines and  
Patent Roll Skinners—Bronze, Semi-Steel, Lead and Iron Castings.

**Manufacturers of Paper and Pulp Making Machinery in**

*All Standard Forms — Many Special Designs*

**ENGINEERS, FOUNDERS AND MACHINISTS**

*Correspondence Invited*

**VALLEY IRON WORKS COMPANY**

**APPLETON, WIS., U.S.A.**

# TOWNSEND

## ELECTROLYTIC CELL

2,500-5000 AMPERE UNITS. ALKALI AND CHLORINE,  
CAUSTIC SODA. BLEACHING POWDER. CHLORINE  
FOR ORES. LICENSES GRANTED. CANADIAN PATENTS  
91939 - 105088 - 105089.

**HOOKER ELECTROCHEMICAL COMPANY**  
40 WALL STREET, NEW YORK

REGISTERED



JOHN KNIGHT, Pres. C. K. WILLIAMS, Treas. C. H. KNIGHT Sec.

## Paper-Makers Chemical Co.

FROM MINE TO MILL

**ENGLISH CHINA CLAYS  
MANUFACTURERS**

**Excelsior Felt Cleaner**

GBB Brand China Clay is  
a natural pure white, no artificial tinting  
Unsurpassed for  
coating, bleaching, or fine papers.

Superior Rosin Size  
Superior Satin White

**EASTON, PA., U.S.A.**

## Paper Coating and Colouring Machines

COMPLETE PLANTS AND ACCESSORIES

The best in the world.

To be obtained from

**Julius Fischer Engineering Works Nordhausen, H.**

GERMANY

*Excellent References in all countries.*

## THE PETER HAY KNIFE CO., Limited, GALT, ONT.

MACHINE

KNIVES,  
CHIPPER,

BARKER &

PAPER-

CUTTER

KNIVES.



Made from the Best English Steel and Warranted.

# CHR. WANDEL

REUTLINGEN, - GERMANY

ESTABLISHED 1869.

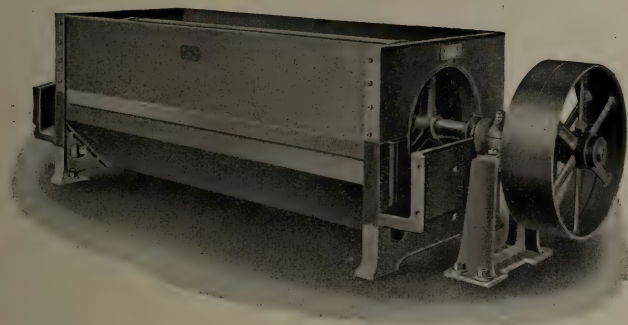

*Manufacturer of the*

## “ORIGINAL WANDEL” Rotary Sulphite Pulp Screen

Satisfactory service sure. Best by test. Beware of imitations. Largest screening surface, combined with small requirement of room. Absolutely reliable and noiseless work. No contact of the pulp with iron parts. Simple, durable, perfect. Price very moderate. The system now adopted by the most important Sulphite Fibre Mills of Europe. Estimates promptly furnished, delivered at any point.

SOLE CANADIAN AGENTS

ARTHUR P. TIPPET & CO.

8 Place Royale

Montreal, Que.

# CROOKES, ROBERTS & Co.

SHEFFIELD

ENGLAND

Makers of

Makers of

Crucible Cast Steel  
Bed Plates  
Jordan Fillings  
Beater Bars

Bessemer Cast Steel  
Crookes'  
Composition  
Fillings



And every description of Cutter Knives, Tools and Steel used and required in Paper Mills.

**ARGUS** High-Speed **STEEL** for fine machine tools is unsurpassed.

Once Used - Always Used

**YOU SAVE MONEY USING "ARGUS" GOODS**

WRITE US

**ARTHUR P. TIPPET & CO.**

Agents for Canada

MONTREAL

# SPENCER'S

ALWAYS



RELIABLE

Best Wool - Best Weave - Best Wear

**J. H. SPENCER & SONS**

**BURY** - **ENGLAND**

Canadian Agents: **ARTHUR P. TIPPET & CO., MONTREAL**



# INDEX TO ADVERTISEMENTS.

(SEE CLASSIFIED ADVERTISERS INDEX ON PAGE XXXI.)

Ambursen Hydraulic Construction Co.	lxv	Dillon Machine Co.	xliv
American Forestry Association	li	Dodge Mfg. Co.	liv
Appleton Machine Co.	liv	Dominion Belting Co.	xlvi
Atterbury Bros. Inc.	lxii	Eaton & Brownell	lviii
Becker & Co.	e.o.m.	Emerson Mfg. Co.	xxv
Beloit Iron Works	xlii	Farrell Foundry & Machine Co.	xxxvii
Bentley & Jackon	v	Ferguson, H. S.	lviii
Bertram, James & Son, Ltd.	xviii	Fischer, Julius	xliv
Bertram's, Limited	vi	Finckh, Hermann	xxxix
Black-Clawson Co., The	x	Fornstedt Gustaf	lxi
Blethen, Hugh R.	lix	Fullner, H.	xxx
Bredt & Co., F.	lii	Garland, M. Co.	xli
Brunner, Mond & Co., Limited	lxvi	Gewerkschaft, Sachtleben	lxiii
Caldwell, H. W. & Son, Co.	xxxii	Gillespie, Geo. H. Co.	lxv
Canada Coating Mills, Limited	lvii	Glens Falls Machine Works	xlix
Canada Paper Co., Ltd.	lvii	Green Bay Barker Co.	xxi
Canadian Boomer & Boschert Press Co.	lx	Hamelin, The, & Ayers Co., Ltd.	lx
Canadian Boving Co.	lv	Hardy, Geo. F.	lviii
Carthage Machine Co.	xxiv	Harmon Machine Co.	viii
Castle, Gotthell & Overton	lii	Hay Knife Co., Peter, Limited	xliv
Chambers & Simpson	vi	Holyoke Machine Co.	xvi
Chicoutimi Pulp Co.	xxvi	Hooker Electrochemical Co.	xliv
China Clay Co.	l	Horn, J. H. & Son	xxxiii
Christie, J. Co.	lxvi	Hough, R.	lxvi
Christie, Limited, George	lxv	Howell Co., The	xlvii
Churchill & Sim	lxii	Jeffrey Mfg. Co.	lii
Crookes, Roberts & Co.	xlvi	Jenckes Machine Co.	xvii
Crossley, T. L.	lviii	Johnson & Sons, Limited, C. H.	xlix
Dallyn, Jardine & Co.	lii		
Dean & Son, Ltd.	liv		
De Cew, J. A.	lix		

## HYDRAULIC TURBINES

One unit of six with a total capacity of 13,100 Horse Power furnished for the new plant of J. R. Booth, Ottawa, Ontario. We build Turbines for any power for heads from 3 to 600 feet.

WRITE FOR CATALOGUE



**S. MORGAN SMITH CO.,**  
YORK - PA.

Jones, E. D. & Sons Co. ....liv  
 Jones & Glassco .....xx  
 Kimball, Herbert S. ....lviii  
 Klipstein & Co., A. ....1  
 Lawrence Machine Co. ....xx  
 Lawrence Pump & Engine Co. ....lii  
 Lea, R. S. & H. S. Ferguson ....lviii  
 Little, Arthur D. Inc. ....lviii  
 Lyford, Clark & Lyford ....lviii  
 Mallandain, Albert E. ....xxxix  
 Marx, J. & Co. ....viii  
 Mardon, Alfred H. ....lx  
 McDougall, John, Caledonian Iron Works  
 Co., Limited .....xxxv  
 Meineke, C. A. & Co. ....1  
 Milne, Jas., and Son .....e.o.m.  
 Moore & White Co. ....xv  
 National Pipe & Foundry Co., Ltd. ....1  
 New Brunswick Pulp and Paper Co.,  
 Limited .....lv1  
 Northern Crane Works, Ltd. ....lxvi  
 Panzl Digester Lining Co. ....lvi  
 Paper Makers Chemical Co. ....xliv  
 Parsons Trading Co. ....xxiv  
 Penmans Limited .....lii  
 Perkins, B. F. & Son .....xxxiv  
 Phillips, S. C. & Co. ....xxxvii  
 Porritt & Son, Joseph .....lii  
 Porritt Bros. & Austin .....xlix  
 Prather, H. B. ....lix  
 Preston's Digester Lining Co. Ltd. ....xxxvi  
 Pride, Chas. B. ....lix  
 Pringle, T. & Sons ....lviii  
 Pullan, E. ....liv  
 Pulp & Paper Trading Co., The .....xxviii  
 Reddaway, F. & Co. ....lv  
 Rice, Barton & Fales .....li  
 Riordon Paper Co., Limited ....lvii

Rolland Paper Co., .....lv1  
 Ryther & Pringle .....xxxiv  
 Sadler & Haworth .....liii  
 Sandy Hill Iron & Brass Works .....x  
 Scandinavian American Trading Co. ....xxix  
 Schaeffer & Budenberg Mfg. Co. ....lxiii  
 Scottish Wirecloth Co. ....xlviii  
 Scott, Ernest & Co. ....xli  
 Sheldons Ltd. ....xlii  
 Sherbrooke Machinery Co., Limited .....xix  
 Smart-Turner Machine Co. ....lxvii  
 Smith, S. Morgan, Co. ....lxvii  
 Snell, Samuel Co. ....1  
 Spencer, J. H. & Sons .....xli  
 Stancliffe Estates Co., Ltd. ....lxiii  
 Stebbins Engineering & Mfg. Co. ....lix  
 Swezey, R. O. & W. G. ....lviii  
 Swenson Evaporator Co. ....xli  
 Taylor, J. A. ....lxv  
 Ticonderoga Machine Works .....xxvi  
 Tippet, Arthur P. & Co. ....xxv-xlv lv1  
 Union Screen Plate Co. ....lii  
 Union Sulphur Co., The .....lxi  
 United Wire Works, Limited .....xxv  
 Valley Iron Works .....xlili  
 Vera Chemical Co. ....ii  
 Voith, J. M. ....vii  
 Walker, J. R. & Co. ....i  
 Wallace, Jos. H. & Co. ....ix  
 Walmsley, Charles & Co. ....xxii-xxiii  
 Wandel, Chr. ....xlv  
 Wandel Screen Mfg. Co. ....lx  
 Waterous Engine Works Co., Ltd. ....lxiv  
 Westby, P. P. ....xi-xxxix  
 West End Engine Works Co. ....xxvii  
 Wilkinson, E. H. ....xxxix-lvi  
 Wilson-Paterson Co. ....xxiv  
 Winn & Holland .....lxvi  
 Zarembo Co. ....e.o.m.

*Scandinavian Sulphite  
 and Ground Wood  
 Kraft Pulp  
 Bleached Sulphate  
 and Sulphite  
 Austrian Bleached  
 Mitscherlich*

Limited quantities still available  
 Write us for quotations and  
 quantities

**THE HOWELL CO.**  
 8-10 Wellington St. East  
**TORONTO - CANADA**

**MAPLE LEAF**  
**STITCHED COTTON DUCK**  
**BELTING**  
**DOMINION BELTING CO. LTD.**  
**HAMILTON CANADA**

**The Scottish Wirecloth**  
 Company, Limited  
 LEITH - - - SCOTLAND

Wirecloth for Paper Machines, etc.

# Glens Falls Machine Works

GLENS FALLS, N.Y.



Sole Manufacturers of

**Tromblee & Paull Rotary Sulphur Burner**

**The Moore Rotary Screen**

**The Reynolds Screen**

Also Manufacture

**Cedar Point Foundry Grinders**

**Improved Standard Grinders**

**Improved Wet Machines**

**Rotary Pumps, etc.**

Write for Particulars and Specifications—they are free.

## C. H. JOHNSON & SONS, Ltd.

WIRE WORKS, ST. HENRY, MONTREAL.

MANUFACTURERS OF

**Fourdrinier Wires, Cylinder Wires,  
Brass, Copper and Iron Wire Cloth, Dandy Rolls**

## PORRITT BROS. & AUSTIN

Stubbins Vale Mills—RAMSBOTTOM—near Manchester, England

Manufacturers of every description of

**FELTS AND JACKETS FOR  
PULP AND PAPER MILLS**

Agents for Canada: C. H. JOHNSON & SONS, Ltd., ST. HENRY, MONTREAL.

WE MANUFACTURE WOODEN WATER PIPE for Water Works Systems. SPECIALLY MADE  
PIPE for Conveying Chemicals. CONTINUOUS STAVE PIPE for Power Plants.  
Sizes from 2 inches to 12 feet diameter.

**NATIONAL PIPE AND FOUNDRY CO., LIMITED**  
Works, Alexandria, Ont. 135 Board of Trade Bldg., MONTREAL, Que.

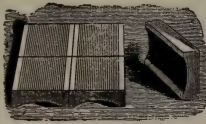

### Use Snell's Drainer Bottoms

They drain quickly and don't let the Pulp go into  
River. No Dust. No Splinters. Clean Stock.

*Send for Sample and Price*

**Samuel Snell Co., - Holyoke, Mass.**

Cable Address:—"Kaolin, Manchester." A.B.C. Codes 4th & 5th Edition

# CHINA CLAY CO.

JOHN WILLIAMSON, Manager.

4 St. Anne's Square

**MANCHESTER, ENG.**

MINES—Ruddle, Bojea, Colchester, South Ninestones, Tronance, St. Austen  
Cornwall.

CONTRACTORS TO H.M. INDIAN GOVERNMENT

Canadian Representatives—C. A. Meincke & Co., 222 Coristine Bldg., Montreal.

## A. KLIPSTEIN & Co. Ltd.

(OF CANADA)

12 ST. PETER ST.

MONTREAL

# SULPHATE ALUMINA

CHINA CLAY, BLEACH and CASEIN  
PAPER BLUE, both Basic and Acid  
AURAMINE - RHODAMINE

and all other Aniline Colors

Shades Carefully Matched in our Laboratory      Mention Pulp & Paper  
Magazine

New York Office - 644-654 Greenwich Street.

# Canadian Pulp and Paper Directory

FOR 1912

A complete reference book comprising the pulp and paper mills, the printing, bookbinding, publishing, stationery and other trades allied to the paper industry. *PRICE \$3.00*

# PAPERMAKERS' POCKETBOOK

BY JAMES BEVERIDGE

Specially compiled for Paper Mill Operatives, Engineers, Chemists and Officials. *PRICE \$3.50*

INDUSTRIAL AND EDUCATIONAL PRESS LIMITED  
TORONTO

*People who are wise Advocate Forestry*

# The American Forestry Magazine

*IS DEVOTED TO SECURING*

**Better Fire Protection**  
**Fair Forest Taxation**  
**Lower Freight Rates**

**Proper Legislation**  
**Conservative Management**  
**and Reforestation**

It should be on the desk of every progressive American citizen. It is the public service publication of the American Forestry Association

**AMERICAN FORESTRY MAGAZINE, ONE YEAR** - \$2.00  
**Membership in American Forestry Association, One Year** - \$1.00

---

**Address AMERICAN FORESTRY ASSOCIATION**  
**Washington, D.C.**



**LAWRENCE PUMP  
AND ENGINE CO.**

P. O. BOX 70, DEPT. 10  
LAWRENCE :: MASS.

**CENTRIFUGAL PUMPS**

We make an exclusive specialty of High Efficiency Centrifugal Pumps for Paper and Pulp Mill. In one mill 49 of our Pumps are running, the customer writes—"Your Pumps are all giving perfect satisfaction."

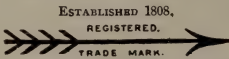
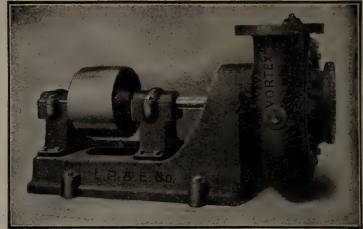

**FELTS** For Pulp and Paper Mills.

**JOSEPH PORRITT & SONS**

Agents for  
Canada  
and United  
States.

**HELMSHORE**  
Manchester, England.

All kinds  
Woollen, Lin-  
en and Cotton  
Cloths for  
Mechanical  
Purposes.

**F. BREDT & CO., 240 Water Street, NEW YORK.**

**PENMANS LIMITED**  
ST. HYACINTHE, QUEBEC

Manufacturers of  
**PULP AND PAPER MAKERS' FELTS,  
JACKETS, STRAINER CLOTHS, ETC.**

Special sizes and qualities made to order. Satisfaction guaranteed.  
**DALLYN, JARDINE & CO. TORONTO Selling Agents**

**CASTLE, GOTTHEIL & OVERTON**

*200 Fifth Avenue, New York*

AGENTS FOR

***Sulphite and Wood Pulp Mills***

Dealers in all kinds of Paperstock, Slizing, etc.

Correspondence Solicited.

# "AMPHIBIA"

(Waterproof)

## Leather Belting

Actually costs less per day  
of service, than any other  
although the purchase price  
may be a little higher.

*Get a trial order and keep  
tab on it.*

*Sadler & Haworth*

Tanners and Manufacturers

MONTREAL  
511 William St.

TORONTO  
27 Melinda St.

ST. JOHN, N.B.  
89 Prince William St.

VANCOUVER  
217 Columbia Ave.

WINNIPEG  
244 Princess Street

For over 35 years the makers  
of the best leather belts

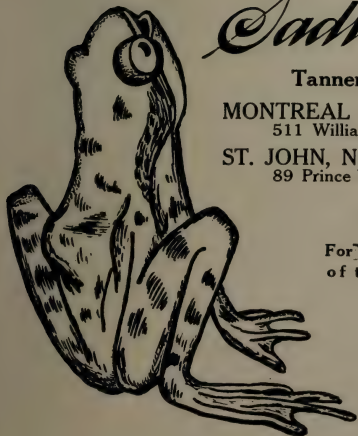

Nearly FIFTY YEARS ago we introduced this Belt. IT HAS STOOD THE TEST OF TIME

2" to 24" in stock

Every Belt is Stamped with Trade-Mark.



Write or phone us

Beware of Imitations

SOLE MAKERS

F. REDDAWAY & CO.,

MONTREAL, CANADA.

**E. PULLAN,** 490 Adelaide St. W., TORONTO

Largest Paper Stock Dealer in Canada

**RAGS AND PAPER STOCK GRADED TO SUIT MILL REQUIREMENTS**

Correspondence Solicited.

EDWARD A. JONES, President and Treasurer

WALLACE E. BARDWELL, Secretary

**E. D. JONES & SONS CO., Pittsfield, Mass.**

Manufacturers of

**PAPER MAKING MACHINERY AND MECHANICAL ENGINEERS**

Beating Engines. Washing Engines. Mixing Engines. Bleaching Engines. Cooking Engines. Vertical and Horizontal Stuff Chests.

Jordan Engines of three sizes, either belt or direct connected motor driven; fillings of Wagg Steel or stone type, three-part or plain. Dusting Machinery of all kinds.

NEW EDITION FOR 1912 NOW READY

A BOOK YOU ARE SURE TO WANT

PRINTED IN CLEAR TYPE

ALPHABETICALLY ARRANGED

**The Paper Maker's Directory of all Nations**

Annuaire de la Papeterie de Toutes les Nations.

Internationales Adressbuch sämtlicher Papierfabrikanten der Welt

Contents Include

Paper, Pulp and Board Mills. Names and Addresses of more than 5,000 in 40 different Countries, with (1) Makes of Paper; (2) Number and width of Machines; (3) Tonnage Output; (4) Power Used; (5) Telegraphic Addresses; (6) Agents, etc. Classified Lists of Principal Productions for each country. Special Buyers' Guide. Paper Agents and Mill representatives (with Mills represented). Paper stainers, Enamellers and Surficers of Paper. Wholesale Stationers and Paper Merchants. Waste Paper Merchants and Rag Merchants & Paper Stock Dealers. Export Merchant Shippers of Paper. Cardboard and Paper Box Manuf'rs. China Clay Merchants. Paper Bag Makers. Buyers' Guide. Sizes (with folds) of British Papers. Paper Trade Customs, Paper Equivalents, &c., &c., British Paper Trade Customs.

PRICE 7/6 NET, POST FREE 11/6

TO BE OBTAINED FROM

**DEAN & SON Ltd. - 160a Fleet St. LONDON, E.C.**

The Red Book of the British Paper Industry



Demy 8vo, Cloth Bound 796 Pages

# "C.B.C." REFINER

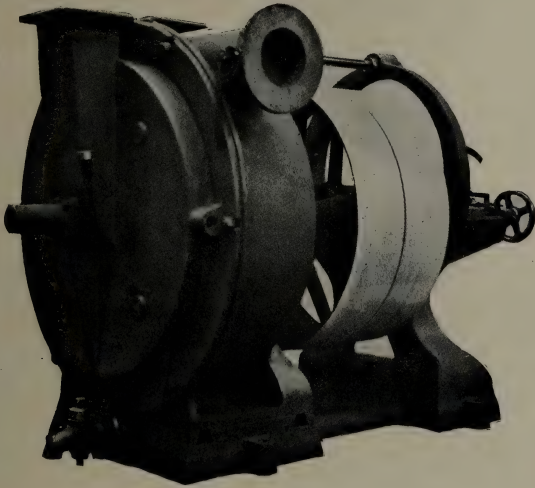

*Great strength and durability.*

*Large working capacity.*

**IT SAVES YOU ALL YOUR SCREENINGS  
i.e., 5 to 10 per cent. of your wood consumption  
IT INCREASES YOUR PRODUCTION  
5 to 10 per cent. without additional power**

## **The Canadian Böying Co., Limited**

**164 BAY ST.                      -                      TORONTO**  
**VANCOUVER OFFICE                      -                      448 SEYMOUR ST.**

## ROLLAND'S PAPERS

For Business Stationery, for Loose Leaf Sheets and all kinds of printed or lithographed forms, include many textures at a wide price range. There is a paper for every need and fancy. Ask your printer to show you our sample books, or write to us for them.

Made in White, Azure and Buff. Envelopes to match all lines.

### THE ROLLAND PAPER COMPANY LIMITED

GENERAL OFFICES - MONTREAL, P.Q.  
MILLS AT ST. JEROME AND MONT ROLLAND, P.Q.

## GENUINE "KRAFT" PAPERS

*Made in Canada*

THE NEW BRUNSWICK PULP & PAPER CO.  
Springfield Mills, Millerton, N.B. Limited

Ontario Representative - E. H. WILKINSON  
Telephone Building, 82 Adelaide Street West - TORONTO

## PANZL'S PATENTED LINING COMPOSITION

IS THE SAFEST AND BEST MATERIAL FOR

**LINING OF SULPHITE PULP DIGESTERS**

AND ACID RECLAIMING TANKS

**PANZL LININGS ARE SAFEST AND MOST DURABLE**

They are really acid-proof and practically indestructible.

All Digesters lined with Panzl's patented composition, now as tight and in as good condition after years of continuous use as they ever were, no leaks and no repairs.

Panzl Linings can be made considerably thinner than the other linings, thus increasing the capacity of the digesters

The composition and the system of constructing of Panzl Linings are patented in all countries where wood pulp is being manufactured by the sulphite process. The PANZL U.S. Patents have been adjudicated to be valid in law and wholly independent of all prior patents relating to linings of digesters.

For information and estimates, address:—

**PANZL DIGESTER LINING COMPANY**  
505 Washington Ave., Muskegon, Mich.



## The Riordon Paper Company, Limited

Fibre, Paper, Lumber.

MONTREAL - CANADA

News Paper, Hanging Paper, Wrapping Paper, Building Paper,  
Celebrated "Impervious" Spruce Sheathing and Sulphite Fibre for all  
kinds of Paper.

## Barber Paper and Coating Mills Ltd.

GEORGETOWN, ONT.



Manufacturers of  
SURFACE COATED BOOK and LITHOGRAPHIC  
PAPERS, COATED CARDBOARD and COATED  
BOXBOARDS of every description.

### "Chalk White" Coated Book Paper.

The best and whitest coated paper sold.

ALL REGULAR SIZES AND WEIGHTS IN STOCK.

Our Art Litho Cover Paper is stocked in four tints,  
2 sizes. 20 x 25 and 21½ x 28½. Samples gladly sent.

MONTREAL  
TORONTO

CANADA PAPER CO.  
LIMITED

WINDSOR  
MILLS, P.O.

# DIRECTORY

of

## Civil and Chemical Engineers

### T. PRINGLE & SON, Limited

Engineers and Architects

Plans and Specifications for Pulp and Paper Mills, Power Plants and other Industrial Works.  
**Coristine Bldg.**                      **Continental Life Bldg.**  
 Montreal.                              Toronto.  
 Bell Tel. : M. 3890.                      Tel. : M. 5917.

### R. S. LEA, and H. S. FERGUSON,

ENGINEERS

Pulp, Paper and Chemical Fibre Mills, Water Power Development and Transmission, Steam Power Plants  
 Telephone Long Distance Up. 75L  
 820 New Birks Bldg., MONTREAL

### Arthur D. Little Inc.

— LABORATORY OF —  
 ENGINEERING CHEMISTRY  
 93 BROAD ST., BOSTON, - MASS.  
 Our staff includes experts in Papermaking Chemistry  
 —Sulphite Mill Practice—Fuel Engineering.

### GEORGE F. HARDY, M. AM. SOC., M. E. M. CAN. SOC. C. E.

Consulting Engineer.

Paper, Pulp and Fibre Mills, Examination of Mill Properties, Water Power Developments.  
 Mutual Reserve Building, - 309 Broadway,  
 NEW YORK.

CHARLES E. EATON,                      JAMES P. BROWNELL,  
 M. Am. Soc., M. E.                      C. F.

### EATON & BROWNELL,

Consulting Engineers and Architects.

Paper, Pulp and Fiber Mills, Water, Steam and Electric Power Development, Examination of Properties, Consultation Reports  
 SMITH BLDG.                      WATERTOWN, N. Y.

### A. V. TRACY-GOULD

Pulp and Paper Mills.                      Power Plants.  
 Waterworks and Sewerage,  
 Examinations. Reports and Surveys.  
 512 New Birks' Bldg., Montreal, P.Q.  
 Telephone : Uptown 6974,

### T. LINSEY CROSSLEY

*Engineering Chemist*

PULP AND PAPER  
 TECHNOLOGY

318 Lagachetiere St., W., Montreal

### R. O. & W. G. SWEEZEY

— Civil and —  
 Forest Engineers

Limit cruising, surveys, water storage,  
 power, lumbering contracts.

METROPOLITAN BLDG., QUEBEC

ASSOCIATED WITH

### HERBERT S. KIMBALL

M. AM. SOC. C. E.

Mill Architect and Engineer

111 Devonshire St., Boston

### FOREST ENGINEERS

FOREST SURVEYS                      LOGGING MAPS

WATER POWER                      TIMBER ESTIMATES                      WATER STORAGE

CLARK, LYFORD & STERLING  
 1331 Real Estate Trust Bldg., Philadelphia  
 CLARK & LYFORD                      LYFORD, CLARK & LYFORD  
 403 Crown Bldg.                      26 Board of Trade Bldg.  
 Vancouver.                      Montreal.

**PULP  
PAPER  
POWER** JOSEPH H. WALLACE & CO.  
INDUSTRIAL ENGINEERS.  
TEMPLE COURT BLDG. NEW YORK.  
SALISBURY HOUSE, LONDON, E.C.  
CABLES, TRIPLEX, N. Y., TRIPLEXIS, LONDON.

**C. B. PRIDE**

**MILL ARCHITECT & ENGINEER**  
**PAPER, FIBER, AND PULP MILLS,**  
**WATER & STEAM POWER DEVELOPMENT**  
 25 YEARS SUCCESSFUL OPERATIONS  
 SPOKANE, WASH. OFFICES APPLETON, WIS.

**J. A. De CEW** M.A. INST. CHEM. ENG.  
A.M. CAN. SOC. C.E.E. *Chemical Engineer*

Paper Mill Analysis Pulp Testing Investigations  
 Sulphite Fibre, Soda Fibre Reports

CANADIAN EXPRESS BUILDING - - - MONTREAL

Power, Lighting, Heating, Ventilating and Drying.—Complete New Plants, Improvement of Old Plants;  
 Plans, Specifications, Contracts, Estimates, Tests, Appraisals, Inspections and Reports.—Pulp, Paper,  
 Box Board and Coating Mills.

Lowest **H. B. PRATHER,** Guaranteed  
 Possible *CONSULTING ENGINEER,* Results.  
 Operating Cost. ROCKFELLER BLDG., CLEVELAND, O.

**HUGH R. BLETHEN**  
**21 PARK ROW, - - - NEW YORK, N.Y.**  
 Traveling Cranes - Overhead Tramways - Trolleys and Chain  
 Hoists for Paper and Pulp Mills - Power Houses.

**Stebbins Engineering & Mfg. Co.**  
**WATERTOWN, N.Y.**

MANUFACTURERS OF  
 STEBBINS' ACID SYSTEMS, SULPHUR BURNER  
 DIGESTER LININGS, RECLAIMERS, ETC.

Engineering Department Plans, Estimates and Specifications for Paper,  
 under Pulp and Fibre Mills,  
 Mr. T. L. TOMLINES Water Power and Hydro-Electric Developments

# LEUNIG PAPER SCALES

Showing correctly at a glance, by weighing a single sheet, the weight of a ream of Paper of any size, containing either 480, 500, or 516 sheets.

Can also be made to indicate in addition to the English weight, the weight in Kilogrammes.

Illustrated Price List on Application.

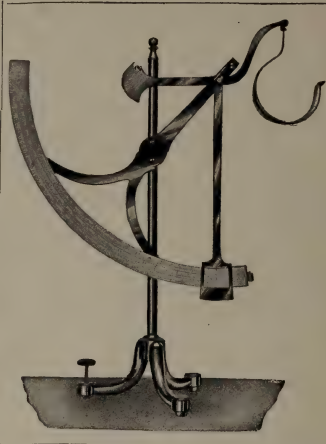

$\frac{1}{2}$  to 80 lbs.

**Price,**  
**Ten Dollars**  
F.O.B., London

$\frac{1}{2}$  to 120 lbs.

**Price,**  
**Fourteen Dollars**  
F.O.B., London

Illustrated Price List on Application.

**Alfred H. Mardon** 150 Shaftesbury Ave. **London, Eng.**

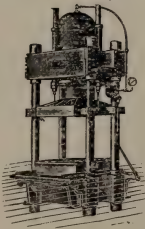

# PULP PRESSES

AND ACCESSORIES

CANADIAN BOOMER & BOSCHERT PRESS  
COMPANY, LIMITED

18 TANSLEY STREET, MONTREAL

"LACHUTE FELTS" Bell Tel. No. 23

# The Hamelin & Ayers Co., Limited

LACHUTE MILLS, P.Q.

MANUFACTURERS OF EVERY DESCRIPTION OF

# FELTS FOR PAPER AND PULP MILLS

"The Best are the Cheapest."

# Every Papermill



*must have a daylight lamp.*

**“HELIA”**

*is a real daylight lamp,*

strong, cheap and economical. By the aid of “Helia,” every graduation of color can be exactly determined with the same precision as in daylight.

---

*Sole Agency in Canada and U.S.*

**GUSTAF FORNSTEDT**

THREE RIVERS - - - QUE

# The Union Sulphur Company

Producers of the Highest Grade Brimstone on the Market

---

Absolutely free from Arsenic, Selenium or Tellurium

---

**The Largest Sulphur Mine in the World**

CALCASIEU PARISH, - LOUISIANA

**Main Offices : Whitehall Bldg., 17 Battery Place  
NEW YORK**



**WE GUARANTEE OUR SIZINGS TO BE ABSOLUTELY CLEAN  
OUR VERA PAPER SIZE**

is purest, strongest and highest free rosin size made. We can furnish you with an ideal rosin size and patented apparatus to use same.

**OUR VERA MILL SIZE**

is the best soluble paper makers' rosin size made. Ready to use in cold or warm water in the ordinary way without apparatus. Gives better satisfaction and is more economical than mill made size.

Our sizings are cleaned by our new patented process and we guarantee this size to be absolutely clean, without the least speck of impurity in the same, preventing thereby black specks in the paper. We are shipping our size in barrels or tank-cars.

**VERA CHEMICAL COMPANY**

Main Office and Western Factory  
NORTH MILWAUKEE, WIS.

Eastern Factory  
STONEHAM, MASS.

**J. R. Walker & Co.**

Importers and  
Packers of

**GRADED RAGS, PAPER STOCK  
ROPE BAGGING, ETC.**

WAREHOUSE, 35 COMMON ST., MONTREAL.

Also Manufacturers of Roofing and Building Papers. Leatherboard and Friction Board

Mills at Sault au Reclot, P.Q.

**ATTERBURY BROTHERS, Incorporated.**

*Importers and Exporters.*

**Wood Pulp, FOREIGN AND DOMESTIC Rags AND Paper Stock**

Potter Building, 145 Nassau Street, New York City.

Cable address "AFFECTIVE," New York.

**CHURCHILL & SIM**

29 CLEMENTS LANE, LONDON, E.C.

And at Manchester

**WOOD PULP AGENTS**

Telegraphic Address:—  
"CHURCHILL, LONDON."

A.B.C. CODE  
5th Edition

## ACCURATE RECORDS

of pressure or vacuum can be obtained only from accurate Recording Gauges—naturally. And accurate records are the only kind that are of any value—that's certain. That's why

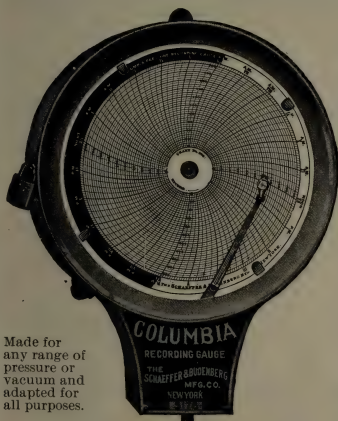

Made for any range of pressure or vacuum and adapted for all purposes.

## “COLUMBIA” Recording Gauges

are so popular and becoming more so every day. Because they *are* accurate and *stay* accurate. Because they are reliable, durable and superior in mechanical detail to all others. Because their charts are uniformly graduated, have wide effective working range and have the *night and day* border.

Still we don't ask you to believe this. Prove it for yourself. Every “Columbia” that leaves our shop is fully *guaranteed* and shipped on *approval*, which means should it not come up to your expectations in every respect, send it back—there is no expense to you.

Send for Pamphlet Q 105 without delay.

The Schaeffer & Budenberg Mfg. Co.  
Chicago BROOKLYN, N.Y. Pittsburgh

## GEWERKSCHAFT SACHTLEBEN

Homburg-Niederrhein, GERMANY

Largest Makers  
of all Qualities

# BLANC FIXE

Three  
Varieties

Bright, Matt or Dull  
Photographic

## THE STANCLIFFE ESTATES CO. LTD.

DARLEY DALE - - - ENGLAND

J. H. DAWSON, Man. Dir.

### BEST ENGLISH PULP STONES

from our celebrated Darley Dale Quarries  
as supplied to the Canadian Market  
Prices and particulars on application

Liebers Code Used

Telegraphic Address, “Stancliffe,” Twodales, England

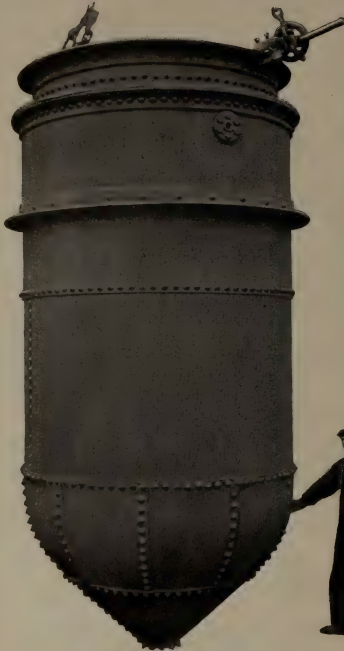

Have Your  
Steel Plate and  
Tank Work  
Built as it  
should be

**WE KNOW HOW!**

This Water Jacket Cooker, 54in. in diameter was built for the Laurentide Pulp and Paper Company, Grand Mere, Quebec

**We have made a success of building Steel Plate Work by specializing in it.**

**We design and build any kind, any size, of Steel Tanks, Storage Bins, Steel Buckets, Cookers and Digesters, Refuse Burners, Conveyors, Spark Arrestors, Steel Stacks.**

*Send us your sketches and let us quote  
Our prices will be reasonable*

---

---

**The Waterous Engine Works Co., Ltd.**

**BRANTFORD,**

**CANADA**

**Geo. Christie Ltd. - - Glasgow  
Scotland**

# **FOURDRINIER MACHINE WIRES**

**Unequalled for Strength, Smoothness and Long Life**

## **CYLINDER COVERS**

**Canadian Agent :**

**J. A. Taylor, 22 St. Francois Xavier St., Montreal**

# **CANADIAN TALC FILLER**

**GEO. H. GILLESPIE COMPANY**

**MADOC - - - ONTARIO**

*The only Manufacturers of Paper Filler in Canada.*

Our Filler is used in Canada, United States, England, Germany, Austria, Holland, Russia and Scandinavia.

# **AMBURSEN HYDRAULIC CONSTRUCTION CO.,**

**OF CANADA, LIMITED**

**822 New Birks Building - MONTREAL**

*Associated with the Ambursen Hydraulic Construction Co., of Boston, Mass.*

## **Concrete Steel Dam**

**OF THE**

**MISSISQUOI PULP CO.,**

**Sheldon, Springs, Vt:**



Mid-channel, height 40 feet.  
Total length 270 feet (only 180 feet shows in the picture, the remainder being concealed at the left.)

Dam specially designed to withstand heavy ice gorges.

Factors of safety, are calculated for a 12-foot flood.

**IF YOU HAVE A DAM TO BUILD, WRITE US NOW.**

Every Grade of Waste for  
Paper Making.

# R. HOUGH

LONDON, England.

Agent for Canada and U.S.,

**THE J. CHRISTIE CO.**

5 King St. West, TORONTO, Canada.

STEAM PUMPS  
CONDENSERS  
VACUUM PUMPS  
TRIPLEX POWER PUMPS  
CENTRIFUGAL PUMPS

**The Smart-Turner  
Machine Co., Limited**

HAMILTON . . . . CANADA

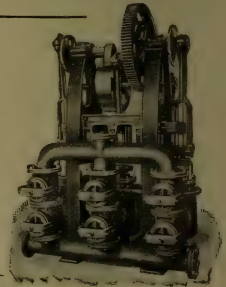

## CRANES

**Hoists and Overhead Trolley Systems**

Any type, size or capacity. Electric or Hand Power.

NORTHERN CRANE WORKS, Ltd., WALKERVILLE, Ont.



# HIGH TEST BLEACHING POWDER

35/38%

(BRUNNER MOND & CO'S.)

**THE STRONGEST AND THEREFORE THE CHEAPEST**  
WINN & HOLLAND, Limited, MONTREAL



# PULP AND PAPER MAGAZINE OF CANADA

VOL. 10 TORONTO, NOVEMBER, 1912 No. 11

## PRINCIPAL CONTENTS

Freight Rates on Pulpwood  
Value of the Rossing Mill  
Western Freight Rates  
The Paper Mill Manager  
Irregularities in Sulphite Digesting  
Process  
Comparison of Colors  
Scientific Manufacture of Sulphite  
Pulp  
Continuous Working Baking Cylinders  
Effects of Beating  
Chemical Problems in Paper Making  
Recent Canadian Patents

# THE JONASSEN PULP REFINER

For the Reclaiming of Ground  
Wood and Sulphite Screenings

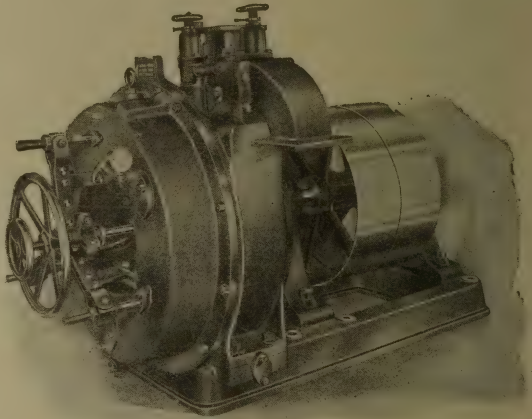

With this Refiner you save all your Ground Wood and Sulphite Tailings or Screenings, which now go to waste.

Capacity of Machine: From 8 to 10 tons of Screenings a day.

Power required to operate same: 20 horse power.

Write us for prices and further information.

## Rice Barton and Fales Machine and Iron Co.

WORCESTER, MASSACHUSETTS, U.S.A.



*Jeffrey Cable Conveyor handling Pulp Wood between buildings in Paper Mill*

**The initial cost of Jeffrey Wire Cable Conveyers for handling and storing pulp wood is not high, compared with the results obtainable.**

The saving in Time, Labor and Expense and the increased capacity effected will more than offset this first cost. They require no expense for maintenance.

We design and build these Conveyers from the ground up, in any desired length, and to suit conditions.

*Ask us to send you copy of Catalog 57-E.*

## **JEFFREY MANUFACTURING CO.**

Canadian Works and Main Office, Montreal. Winnipeg Representatives, N. J. Dinneen & Co.

E. J. WELCH, *President and Managing Director*  
HENRY W. S. DOWNS, *Superintendent*

EMMONS CROCKER, *Vice-President*  
A. S. MORSE, *Secretary and Treasurer*

# **SCREEN PLATES**



**The "Union" Bronze (best phosphorized cast metal) Plates for Sulphite Mills. The Standard Rolled Brass Plates. The "Union" Cast Metal Suction Plates.**

We carry a large stock of blanks of the various sizes in both metals and can fill all orders promptly.

Old plates reclosed and recut by our process are practically as good as new and give better results than by any other process

## **Union Screen Plate Co. of Canada, Limited**

**FACTORY: LENNOXVILLE, QUEBEC.**

**OFFICES: Lennoxville, Quebec, and Fitchburg, Massachusetts, U. S. A.**

— THE BEST —  
**JORDON ENGINE**  
 IS BUILT BY THE

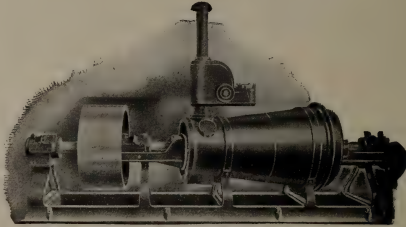

**APPLETON MACHINE CO.**  
 APPLETON, WIS.  
 SEND FOR PARTICULARS

**DODGE**

**Transmission** —\*

—\* **Machinery**

— **High Grade Only** —

**Shafting, Hangers, Pulleys,  
 Friction Clutch Pulleys.**

**DODGE MANUFACTURING CO.**

640 ST. PAUL ST. HAYMARKET SQUARE **MONTREAL** LIMITED

Telegrams :  
"CALENDER, BURY"

Telephone :  
NUMBER 340

# Bentley & Jackson,

Limited

PAPER MAKERS'

.. ENGINEERS ..

BURY, - - ENGLAND

*SPECIALITIES.*

MODERN HIGH SPEED NEWS PAPER  
MAKING MACHINES

SINGLE CYLINDER PAPER MAKING  
MACHINES

*The NEW "MARSHALL" PATENT REFINING ENGINE*  
with separate adjustment to cones and discs, and our patent  
Ball Thrust Bearing

**HELIN'S PATENTED BEATING MATERIAL**  
for Beater Rolls and Bedplates in all types of Hollanders.  
"Marshall" Refiners and "Jordan" Engines filled  
with this material are giving excellent results.



# Bertrams Limited

SCIENNES

Edinburgh

- -

Scotland

---

---

*Fast Running Paper Making  
Machines*

*Single Cylinder Machines*

*Bleaching, Washing and Beating  
Engines*

*Improved Refining Engine*

*Motor Driven Centrifugal Pumps*

*Highest Quality Hard Metal  
Screen Plates*

---

---

Full particulars from

**CHAMBERS & SIMPSON**

152 Bay St. - Toronto, Ont.

# J. M. VOITH

Engineering Works and Foundries

HEIDENHEIM  $\frac{1}{2}$  Brz. - - (Wurt.)

Voith's  
Magazine  
Grinder

Patented in all  
the principal  
countries

Manufactured  
in Canada

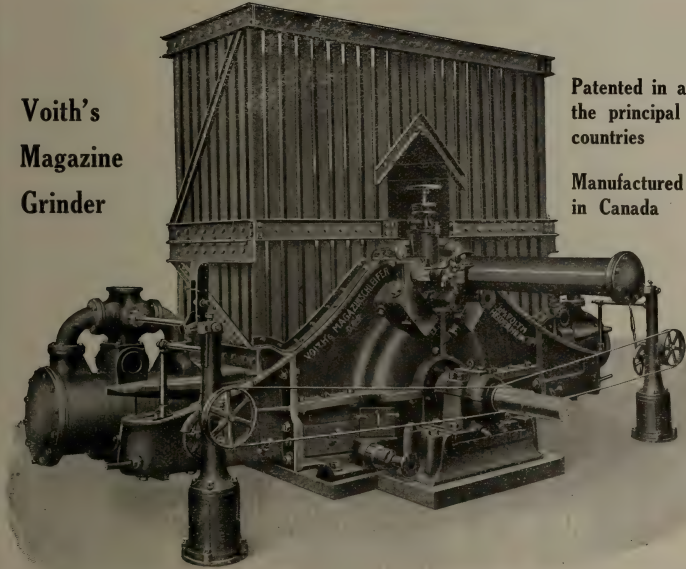

Automatic Feeding and Reversing of Presses. 1 Grinder consumes up to 1200 h.p.  
Of more than 65 apparatus ordered, 25 already delivered  
and working most satisfactorily

SPECIALTIES— COMPLETE MACHINERY FOR  
WOOD PULP, PAPER AND SULPHITE MILLS

Branch Office for Canada and U.S.A. - 1008 Fifth Ave. Bldg., New York  
H. F. STORRER, C.E.

## J. Marx & Co., - - London, E.C., England

Double Beaters with 1 Basalt Lava Roll and 1 Steel Roll in Concrete Beater Troughs, greatly improve quality of paper, especially News.

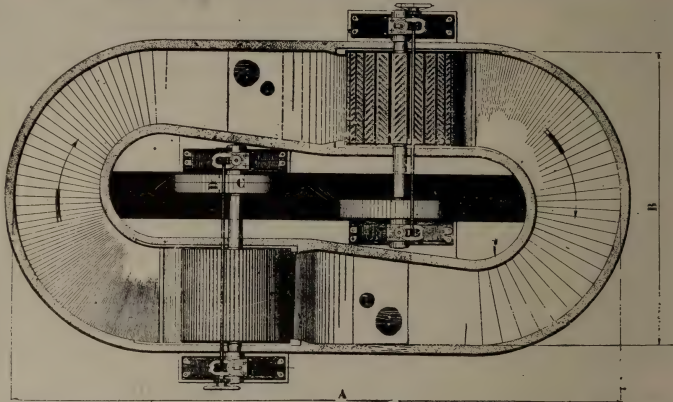

**SPECIALITIES:** Margalt Suction Rolls, Basalt Lava Stone Beater Rolls, Stone Wet Press Rolls, Basalt Lava Pulp Refiners for Screenings.

Canadian  
Representative

**Judson A. DeCew**

Canadian Express  
Building

**Montreal**

*The*

# Harmon Incline Screening System

Will give greatest capacity.

Will give cleaner stock.

Will save power.

Will save labor.

Does not require use of Rakers.

Write us for full descriptive Catalogue and testimonials from the best mills in the country.

## HARMON MACHINE COMPANY

WATERTOWN, N. Y., U. S. A.

OTTO WANDEL  
President

HERBERT H. MILLER  
Treasurer

# Wandel Screen Manufacturing Co.

WALPOLE, MASS., U.S.A.

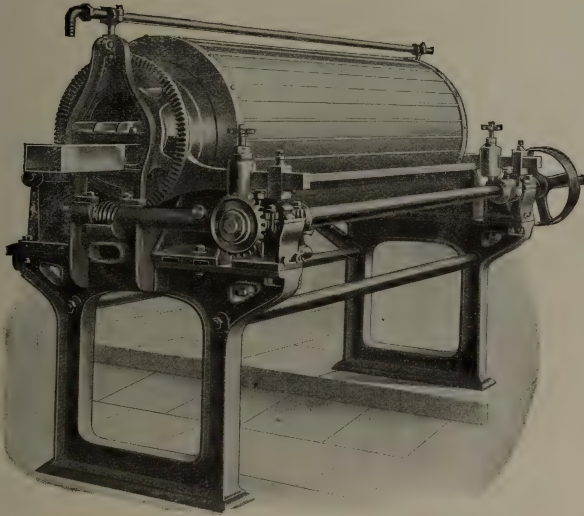

MANUFACTURERS OF THE

Quick Delivery.  
Write for Catalogue  
and list of users.  
We have no author-  
ized Agents in  
Canada.

# WANDEL ROTARY SCREEN

Over 200 Wandel  
Screens have  
been built and sold  
by us in the States  
within two years.

## SUPERIOR CONSTRUCTION

---

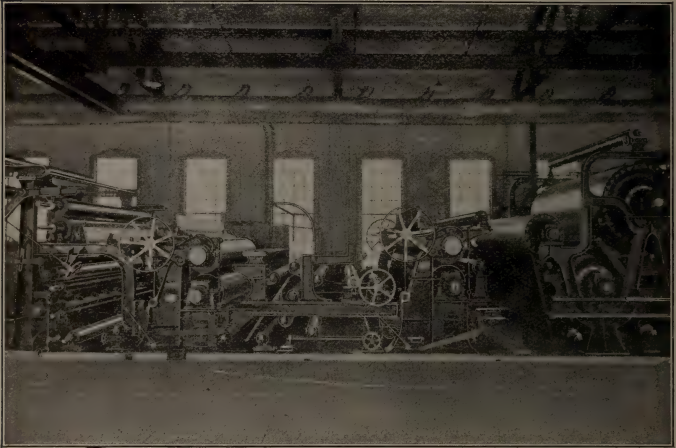
**THE SANDY HILL IRON AND BRASS WORKS, HUDSON FALLS, N.Y.**

130" HARPER FOURDRINIER PAPER MACHINE

---

## A GOOD JORDAN ENGINE

BUILT IN 3 SIZES.



## THE BLACK-CLAWSON CO.

HAMILTON, OHIO, U.S.A

Builders of **PAPER MAKING MACHINES** and machinery for Paper and Pulp Mills. Our machines are completely erected in shop on cast iron levelling plates and carefully inspected before shipment.

*Write for Catalogue.*



# The "WESTBYE" SCREEN

*Its Novel Features are of Importance to You*

Built for Belt or Motor Drive



Investigate and learn something NEW in the screen line

*For Details and Prices  
apply to*

**P. P. WESTBYE**  
**PETERBOROUGH,**  
**CANADA**



**MOVABLE CRANE  
PULP LOG  
STORAGE SYSTEM  
AND UNLOADER**

---

---

**The M. Garland Company**

BAY CITY, MICHIGAN

**Inventors of the Cable Conveyer**

# BELOIT IRON WORKS

## PATENT ADJUSTABLE STEAM JOINT AND DUPLEX SAFETY VALVE

*The latest improved and most up-to-date steam joint in use*  
*No Packing Required* *All Metal Joints*

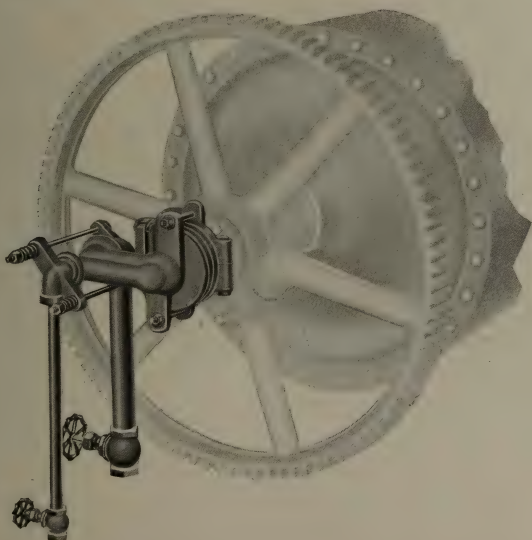

Self Adjustable. Takes care of expansion and contraction, also irregularity of piping. A positive safety valve pressure in dryers cannot exceed a determined amount

Over 1500 sold in the past three years

WRITE US FOR FURTHER INFORMATION AND PRICES

# BELOIT IRON WORKS

BELOIT . . . . . WIS., U.S.A.

LEADING BUILDERS OF PAPER MILL MACHINERY SINCE 1856

# DILLON MACHINE CO

BUILDERS OF

## PAPER MILL MACHINERY

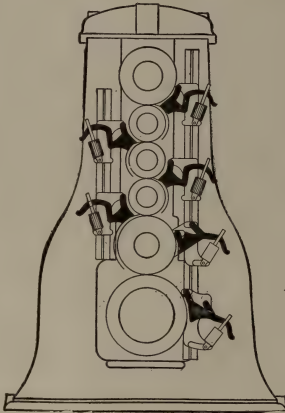

- Beating Engines
- Washing Engines
- Jordan's Three Sizes—  
Single, Double & Triple  
Stuff Pumps, with  
Dillon Patent Valve  
Seating
- Brannan Patent Paper  
Folders
- Horizontal and Vertical  
Stuff Chests
- Single and Double Paper  
Cutters
- Backstands
- Plates, Knives and Bars

**DILLON  
PATENT  
DOCTORS  
AND FEEDS  
MADE IN  
CANADA  
BY THE  
SHERBROOKE  
IRON WORKS,  
SHERBROOKE, P.Q.**

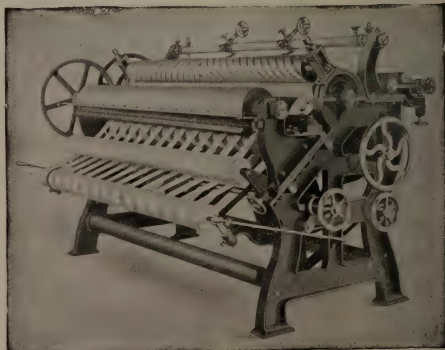

# LAWRENCE, MASS., U.S.A.

---

---

# THE MOORE & WHITE CO.

ENGINEERS, FOUNDERS, MACHINISTS

PAPER MACHINE BUILDERS

Inquiries solicited and given prompt and careful attention.

Specifications and estimates for paper and pulp machinery on either new or repair work cheerfully given

Quality guaranteed strictly high-grade



Office and Works, North Philadelphia Station, P. R. R.  
Philadelphia, U. S. A.

PAPER MACHINES FOR ALL GRADES OF PAPER

ALL GRADES OF BOX BOARDS

ROOFING, FELT AND BUILDING PAPERS

SATURATING AND ASPHALT COATING MACHINERY

“M & W” FRICTION CLUTCHES

“M & W” VARIABLE SPEED CHANGES

PRINTING MACHINES

FOR FLOOR CLOTH AND LINOLEUM

Bulletins and information on any of the above subjects sent on request.

---

---



# HOLYOKE MACHINE COMPANY

HOLYOKE, MASS., U.S.A.

MANUFACTURERS OF

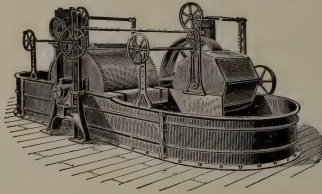

Washing and Beating Engines with Patent Double Hoist and Tubs of either wood or iron.

Hydraulic Pumps and Presses.

Rag Cutters and Rag Dusters.



Cotton and Paper Rolls with Patent Fastenings.

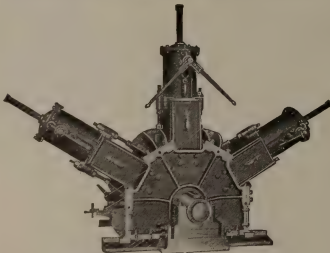

Patent Improved Wood Pulp Grinder.

Elevators, Rotary Fire Pumps and Friction Gearing.

Gears Accurately Spaced and Planed.

Shafting, Pulleys and Mill Work.

Machinery for Wood Pulp and Paper Mills.

Vertical and Horizontal Water Wheels with Flumes and all connections.

Wood Barkers, Wood Chippers and Wet Machines.

## Newest Designs

AND

## Highest Efficiency

Calenders. All kinds of Super Calenders, Friction Calenders and Platers.

Chilled Iron Rolls.

Special Machinery

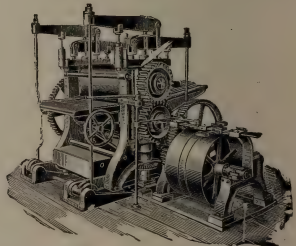

**Description and Estimates Furnished; also Gear List and Catalogs sent on application.**

# Pulp Mill Machinery

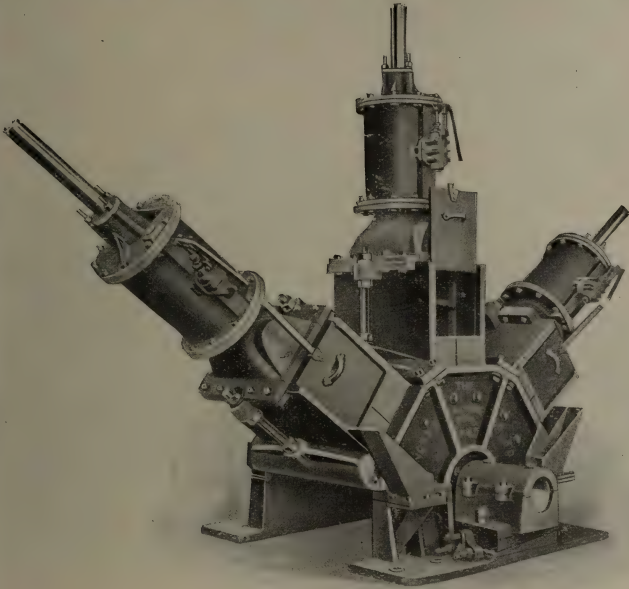

Our Grinders combine the latest and best features in Wood Pulp Grinder construction and have many recent improvements.

We also manufacture Wet Machines, Screens, Presses, Barkers, Complete Wood Room Equipment and Turbine Water Wheels.

LET US QUOTE ON YOUR REQUIREMENTS.

## The Jenckes Machine Co., Limited

General Offices: SHERBROOKE, QUE.

Factories: Sherbrooke, Que., St. Catharines, Ont.

Sales Offices: SHERBROOKE, MONTREAL, ST. CATHARINES, COBALT  
SOUTH PORCUPINE, VANCOUVER, NELSON, B.C.

---

---

# JAMES BERTRAM & SON, LIMITED

LEITH WALK

EDINBURGH . . . SCOTLAND

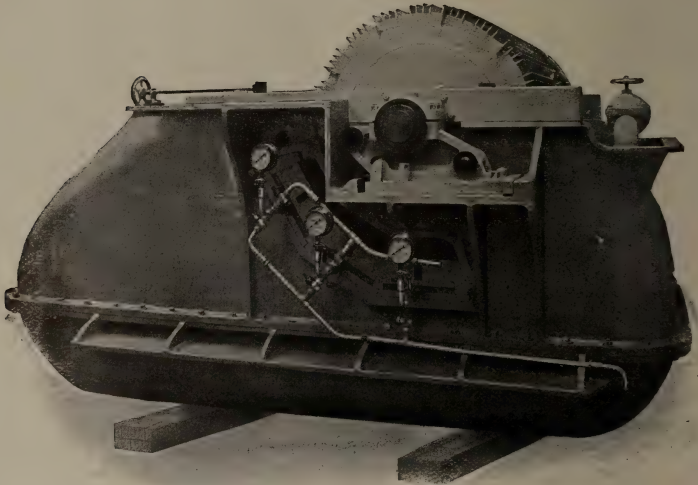

## Umpherston Beating Engine

Fitted with Three Patent Hydraulic Moving Plates

---

At work with great success, saving  $33\frac{1}{2}$  per cent. in TIME and POWER, and producing a superior Finished Sheet of Paper

---

Full particulars on application

Telegrams—Bertram, Leith

---

---

# PNEUMATIC

## Save-Alls, Pulp Thickeners and Filters

Remember that we make Special Pneumatic Machinery,  
not only for saving waste from white water but for  
thickening pulp and

*for filtering river water*

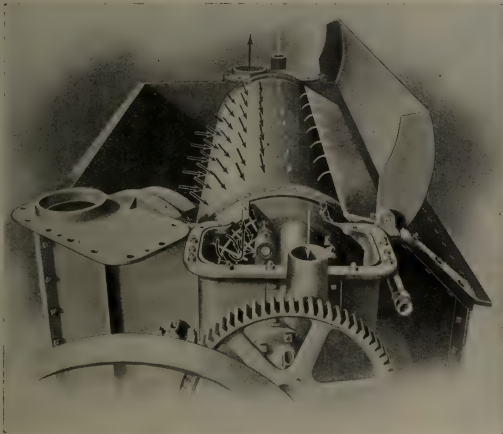

Pneumatic Action of the Save-All

The same pneumatic principle which has made our Pneumatic Save-alls and Pulp thickeners so successful has proved wonderfully effective in our Pneumatic Filter for river water. In this machine we employ an exceedingly fine cylinder-mold facing, through which several million gallons of water per 24 hours can be filtered clean. The clean filtering is due to the minute "mesh" of the covering and the continuous cleansing with air-blast and water-jet; the enormous capacity is due to the pneumatic action; the long life of this Filter is due to the absence of all mechanical wear upon the cylinder.

This machine is filtering clean even in cases where the river is exceptionally dirty because of saw mills located upstream.

*Send for particulars*

---



---

**Sherbrooke Machinery Company**  
LIMITED

SHERBROOKE

QUEBEC

### RENOLD PATENT SILENT CHAINS

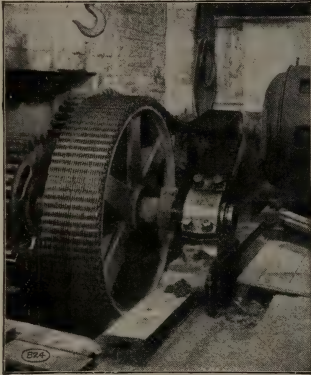

(Drive Stationary)

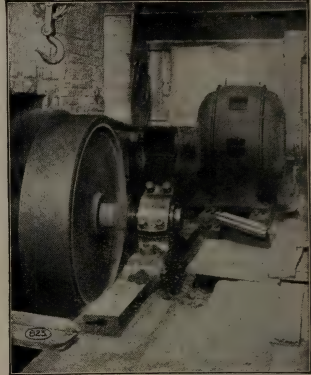

(Chain Speed 1,180 f. p. m.)

150 h.p. Line Shaft Drive

**NOT AFFECTED BY HEAT, VAPOR OR MOISTURE**

We have installed, and in some cases completely equipped, the largest and foremost Pulp and Paper Mills in Canada with the Renold Chains

**JONES & GLASSCO**

ENGINEERS

Registered

SOLE CANADIAN AGENTS

MONTREAL

# Lawrence Machine Co.

LAWRENCE

MASS.

— MANUFACTURERS OF —

## Lawrence Centrifugal Pumps

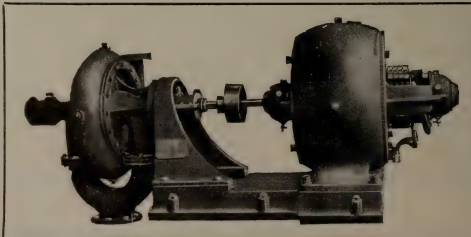

LET US FIGURE ON YOUR REQUIREMENTS



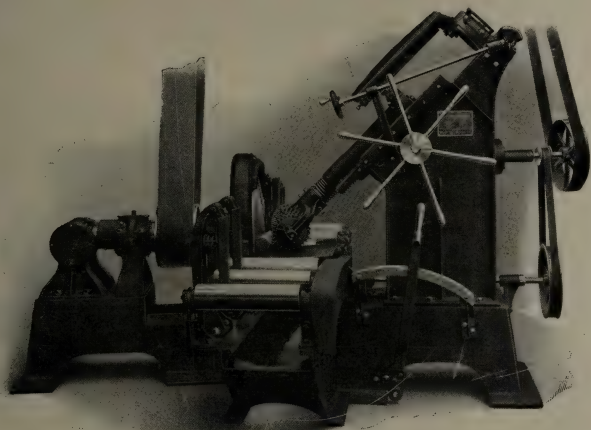

## Are You Aware of the Fact?

That the Robert & Libert Green Bay  
Barker covers every pulp producing  
country in the world.

### Green Bay Barker Co.

GREEN BAY, WIS.

KUUSANKOSRI, FINLAND.



Interior of the  
Machine  
Room of  
Messrs. Ed-  
ward Lloyd,  
Ltd.

Sittingbourne,  
England,  
containing the  
last two  
machines  
supplied to  
this Company  
by Chas.  
Walmsley &  
Co., Ltd.



These "Walmsley" Fast News Machines are 175 inches wide, and are making paper at over 600 feet per minute, with an output of 500 tons news print weekly. The machines are equipped with the Lloyd and Hutchison Patent Drive. This patent device is controlled by Walmsley & Co., Ltd., and dispenses entirely with Friction Clutches and Gear Wheels.

# Charles Walmsley & Co. Ltd.

PAPER MAKERS' ENGINEERS

Head Offices,  
ATLAS WORKS  
Brynch, WOOD STREET

BURY - England

Codes, WESTERN UNION, A.B.C. 5TH EDITION,  
McNEILL'S 1908

Telegrams, "PUMPS, BURY."  
Telephone, BURY 499

## SPECIALTIES—

Complete Paper Mill Plants  
Variable Speed Enclosed Steam Engines  
Cone Beaters for News Stock  
Slitting and Re-Reeling Machines  
Beating and Refining Engines  
Super Calenders  
Buffing Machines, etc., etc.

## FOREIGN REPRESENTATIVES

Norway, Sweden and Finland :  
N. A. EIE - Christiania  
Austria, Hungary :  
F. SCHOFFEL, Engineer, Vienne  
CANADA :  
C. H. JOHNSON & SONS  
LIMITED  
ST. HENRY, MONTREAL

# Wilson-Paterson Co'y



127 BOARD OF TRADE BLDG., MONTREAL.

Agents for the United Alkali Co. of England

## ***OFFER TO THE TRADE:***

Caustic Soda 60° to 78° Soda Ash, Caustic Potash, Sal Soda, Silicate of Soda, China Clay, Rosin size and a full line of Rosins, direct shipment from the south.

**Contracts made for regular supplies.**

# PARSONS TRADING COMPANY

*Exporters of Paper to all Parts of the World*

WHITEHALL BLDG., 17 BATTERY PLACE, NEW YORK

BRANCH OFFICES AT

LONDON

SYDNEY

MELBOURNE

WELLINGTON

CAPE TOWN

BOMBAY

HAVANA

MEXICO, D.F.

BUENOS AIRES

**CORRESPONDENCE WITH MILLS SOLICITED**

# THE CARTHAGE CHIPPER

WILL INCREASE YOUR CHIPS. WILL  
DECREASE YOUR SAWDUST. By virtue  
of its Design and its Patent Feed Spout it takes a  
MINIMUM AMOUNT OF POWER.

---

Ask Anglo-Newfoundland Development Co.  
Ask Laurentide Pulp and Paper Company.  
Ask The Riordon Paper Company, Limited.

---

OR WRITE

**CARTHAGE MACHINE CO.**  
**CARTHAGE, N.Y.**

# Pulp and Paper Magazine of Canada

*A Magazine devoted to the interests of Canadian Pulp and Paper Manufacturers and the Paper Trade.*

SUBSCRIPTION PRICE; \$2.00 a year. Single Copies, 20 cents.

OFFICE OF PUBLICATION: 243-4-5 Confederation Life Building, Toronto, Canada  
MONTREAL OFFICE: 34.B. Board of Trade Building

## *Freight Rates on Pulpwood*

Some see in the proposal of the railroads to raise their freight charges on pulpwood the hand of a protectionist Government trying to place restrictions on the export of wood out of the country without the onus of placing a tax on the same. Be this as it may, there is keen interest in the proceedings before the Board of Railroad Commissioners, not only on the part of American importers, but by Canadian pulp mills and pulpwood dealers. The latter are just as much interested as those across the border, while some pulp mills fear that if the railroad argument for higher rates on wood be acceded to, the next move will be to increase freight on pulp. Not only this, but several Canadian pulp manufacturers have been buying supplies of wood in the open market so as to get the advantage in the United States market accruing from shipping pulp made from wood grown on freehold lands.

The proposed increases in rate range from  $\frac{1}{2}$ c. to 3c. per 100 lbs. For instance, from Drummondville, Que., to Bellows Falls, N.Y., the present rate is 9c., proposed rate  $11\frac{1}{2}$ c.; Point Levi, Que., to Fort Edward,

now 8c., proposed, 9c.; Quebec to Fulton, N.Y., now  $11\frac{1}{2}$ c., proposed  $14\frac{1}{2}$ c.

The pulpwood interests allege that present rates established voluntarily many years ago, are reasonable and presumably remunerative, the railroads carrying an immense volume of traffic under the same. The present rates exceed those of many common carriers performing similar or greater services in the transportation of pulpwood. They are in alignment with existing rates to other important points of destination, which rates are left undisturbed and form a discrimination against the most important pulpwood consuming section in the Eastern States.

Moreover, they claim the character and volume of this traffic is such that it demands and has always been accorded low rates.

They further contend that the movement of pulpwood to United States points will not be reduced by the rate advance, but rather that the wood will tend to move more and more by water and force the inland producing sections to take lower prices or abandon sales to the heretofore profitable American markets



to which the advances apply. Water competition had a vital influence in establishing the present blanket rates, and the advance from inland points will tend to force such points to deduct the advance from their prices or lose the sales.

On the other hand, the railroads claim that they have been for years carrying pulpwood at a losing scale of charges. At first, the trade was so insignificant that this did not matter, but now that it has attained to large proportions, they cannot afford to carry it at such rates.

It is, of course, impossible to say how these various claims will appeal to the Railway Commissioners, but the case will be watched with intense interest, not only by the pulpwood dealers and the small settlers who do not like to see anything happen likely to disturb their market, but by the pulp mills whose interests are generally on the other side and who naturally would welcome a rate change which would tend to ease the market for their prime raw material.

#### VALUE OF THE ROSSING MILL.

In reference to the New Brunswick Government's prohibition of the export of pulpwood from Crown Lands, while this may be in the general interest of the country, yet the way this legislation affects certain portions may be detrimental. At least this, not unnaturally, is the feeling of those who operate rossing mills, especially in sections where the absence of water powers renders the operation of ground wood mills out of the question. Mr. J. W. Brankley, general manager of the Miramichi Lumber Co., Chatham, which, besides its large lumber business, has a rossing mill, writes a letter in which this point of view is put forward in a very lucid manner. In the first place, a great deal of the wood that is used in rossing mills comes from the tops of trees that are cut for the sawmill

and these tops when cut down to 6 inches at the top end are of no use at all for the sawmill. Instead of leaving these tops of trees in the woods as a great many sawmill men do because of the fact that it does not pay them to bring out such small timber and cut it up into deals or boards, this small material is brought in and used in the rossing mill. This small material where the sawmill is concerned is lost to the Province. The rossing mill, on the other hand, pays men to bring this small stuff out of the woods. It should be remembered that only that which is cut from the tops of trees is utilized for the Government will not tolerate cutting anything that will not give 9 inches at the top end of a butt log, and for this the Government is paid, not only the regular timber stumpage fee, but an additional 20 per cent. because it is destined to be made into rossed wood for exportation.

Another point about a rossing mill is this: there are in the Province of New Brunswick many sections that by reason of the nature of the land and climatic conditions are capable of producing only a stunted or undersized growth of timber. It can never reach any large growth and for this reason would never be utilized by anything but a rossing mill. In fact, no sawmill could use it. This timber is made valuable where a rossing mill is located and it becomes as valuable to the Province and the citizens of the Province as any other timberland in the Province.

By accounts carefully worked out there is said to be 25 per cent. more money expended and labor employed on an acre of land for pulp logs that go to a rossing mill than on what saw logs can be got from that acre in particular.

Thus a rossing mill not only utilizes timber that is otherwise lost to the country, but removes from the woods a very probable source of danger by fire to the standing timber

growing on these Crown lands and private lands.

The proposition presented above is a difficult one. We believe that restrictions on the export of pulpwood are for the benefit of a country on the whole, because they tend to the establishment of pulp mills, from which there is a large additional profit. But undoubtedly the raw material for pulp manufacture exists in several sections where it would not be feasible to erect pulp mills. Probably in the end, however, the remedy will be found to lie in transporting the rossed wood from sections unadapted to pulp mills to sections which are adapted to the same; and, with an increasing number of the latter superinduced by the restrictions, the difficulty will solve itself in time. This does not seem to be quite fair to such localities as are spoken of by Mr. Brankley, and yet, after all, it is a present sacrifice of a small part for the future good of the whole.

---

### WESTERN FREIGHT RATES.

The railroads are putting up a great fight before the Board of Railway Commissioners against the application of western boards of trade and business men for a reduction of freight rates. Complaint is made that there is unjust discrimination in the western rates as compared with rates in Eastern Canada. In their turn, the railroads interested presented a mass of evidence to show that freight rates in the West compared favorably with those charged by American roads under similar circumstances, in spite of the restrictions on the latter made by the Interstate Commerce Commission. The C. P. R. representatives mentioned the flat rate of 10c. on grain from any western point to Fort William as being the lowest rate on this commodity prevailing in any country in the world.

The railroads also put forward a strong argument based on a comparison of the rates charged in Western Canada on newsprint, building, roofing, and wrapping papers, compared with those between analogous points in the Western States. For example, the rate from Fargo, North Dakota, to Vriska, North Dakota, 48 miles, building and roofing, newsprint and wrapping paper, C. L. 12c., L. C. L. 20c. From Omaha, Neb., to Have-lock, Neb., 50 miles, C. L. 12c, L. C. L. 20c. From Thief River, Man., to Lankin, North Dakota, 92 miles, building and roofing, 17c, newsprint and wrapping 28c. From Winnipeg to High Bluff, Man., 49 miles, building and roofing, C. L. 11c., L. C. L. 12c., wrapping 11c., newsprint 12c. From Winnipeg to Melbourne, 99 miles, building and roofing 17c, and 19c., wrapping and newsprint 17c. and 25c.

The railroads' explanation of the fact that rates in the West are higher than in the East is to the effect that in the latter there is water competition, also that in the West wages are higher, coal is often difficult to obtain, and, owing to the excessive cold, the hauling capacity of locomotives is reduced sometimes to the extent of 50 per cent.

A plausible case, no doubt for the railroads, but there are many ways of sweetening the pill which the public has to take, the pill based on the fact that the railroads will, one way or another, charge all the traffic will bear.

---

The Forestry Department of Toronto University has been almost deluged recently with requests to supply trained foresters. Twelve men who left the school last year have all found positions of responsibility with the various Governments or the railroads. The majority of the recent graduates have been taken by the Dominion Government, but the

institution of a progressive forest policy in the Province of British Columbia has brought about an extra demand, and large salaries are being offered to technically trained men. Dean Farnow foresees a shortage which will to a certain extent cripple

the forest services. He is, therefore, allowing men of the other natural and applied science courses to enter the forestry faculty under special regulations and complete their four years so as to secure the degree of B. Sc. F.

## The Paper Mill Manager

(Special Article by Alex. Annandale, of Scotland)

In this article it is proposed to deal with the qualification of a papermaker called upon to act in such a position. It will be well to state that by the term "Paper Mill Manager" is meant a man who is competent to deal with the whole trade of a paper mill, that is, the general working of the mill, the purchase of materials, the manufacture of the various qualities and the sale of the finished product.

The qualifications of such a man are many and varied. In the first place he ought to be a thoroughly practical papermaker, that is, able to do anything in the mill with his own hands if necessary. This is essential so that he may thoroughly train up his men in the various departments and keep them right. Having this practical training, he will find it a simple matter to gain the respect of all his employes, as they will very quickly realize that he knows the work and understands how it is best put through satisfactorily. He also requires to have a good knowledge of engineering, that is, as regards development and transmission of power, care of machinery, the best arrangement of plant in a mill, how long any repairs should take, what to do in the event of a breakdown, etc.

Next, he should have a thorough knowledge of all the materials he is likely to be called upon to use, that is to say he wants to understand the results obtainable from them when used either singly or in combination, and the best way to treat them; also the percentage of fibre each should yield. He wants to have a good general knowledge of chemistry, but more especi-

ally of the chemistry of papermaking. This knowledge he ought to make daily use of, as it is little use having the knowledge without making use of it, because in most paper mills the chemical bill is a very heavy item, and if not sharply looked after will certainly become a very serious drain on profits.

Further, he requires to be properly economical in every direction; by this it is not meant that he should be parsimonious and cheese-paring (that will not pay), but he must see that he gets full value for all expenditure made. False economy must be strictly avoided. As a general rule, when expenditure is being considered for alterations or new plant it is his business to look ahead and see how he is going to justify the return within reasonable time of the expenditure to be made.

It is also important that he should have a good personal knowledge of his customers—that is, of their requirements and their general character, and he wants to make it his business to see that any of their special wishes as to making, packing and marking of their papers are carefully carried out.

Further, he wants to have a good general knowledge of printing (letter press and litho), ruling, envelope making and the other numerous ways in which paper is used. This, in order that he may be in a position to write and talk intelligently to his customers, and at the same time to know and be able to explain to them how he proposes to produce a paper to suit their specified requirements. Such matters judiciously explained to customers carry great weight and help largely

in securing good business. The above are some of the more important qualifications he requires, and if he wants to progress he must keep himself up to date in all these directions.

Given a papermaker with all these qualifications, it is necessary that he should realize that he cannot do everything himself, and that he must have a reliable staff working hand in hand with him. He must undoubtedly always be the chief, but he must not be bigoted, and should always be ready to discuss any suggested improvement which comes from a member of his staff or one of his workers. When he adopts any such suggestion, he should always give the suggester full credit for it, as nothing prevents men thinking out improvements more than the knowledge that these suggestions will be used and taken credit for by their chief.

The duty of a manager is to be ubiquitous and to be all over the place seeing that everything is working smoothly and well and keeping it so. He does not want to tie himself down to routine work—let him leave that to his staff, subject to his supervision.

On all points he and his men must pull together, with the object of getting the very best results out of the mill, and they should have a joint pride in working up the quality and quantity of the output till the mill is looked upon as number one for its class of paper.

The manager's spirit will assuredly permeate the rest of the employes if he goes the right way to work. He must be tactful, realize that men have different dispositions and that they require to be differently treated in order to get the best work out of them. He wants to be just and fair with everyone and he will have his reward. All the same he need not hope to be quite free from worries. These are the unavoidable heritage of the manager, and these he has to tackle as they crop up with determination but without fuss. If he does this and carries his workers along with him there is no doubt about the success of the mill.

As the writer happens to be in the position of being able to speak from the point of view of a mill owner, a managing

director and a manager, he thinks it will not be out of order for him to conclude this article by a word of advice to those who are interested in paper mills, either as owners or directors. That advice is:—If you have a manager with all, or nearly all, the qualifications indicated in the foregoing lines running your mill, help him all you can, but do not worry him, and you will have no reason to regret doing so when the accounts are made up at the end of the year's trading.

---

#### IMITATION PARCHMENT.

Parchment paper is itself an imitation, as its name implies. As soon as its value as a wrapping material, especially for perishable goods such as foods, was proved, attempts were made to obtain a cheap imitation, one, if possible, as much cheaper than real parchment paper as real parchment paper is cheaper than real parchment.

Imitation parchment paper formerly consisted mainly of pure cellulose from rags, worked in the hollander till there was hardly any recognizable fibre left. To increase the deception, or, perhaps, in the hope that the product would really be a satisfactory substitute for real parchment paper, sulphuric acid was often put in the hollander.

Paper made in this way from rags resembled its prototype in being very close and very transparent, impenetrable to air, water and grease, and in not being very far inferior to it in toughness and strength. It became too dear in its turn, and so yet another imitation had to be put on the market, a fourth product, made with the now inevitable wood pulp. Naturally these imitations of imitations of paper which is an imitation of parchment, recede still further than their immediate predecessors from a state of grace, which in this connection means suitability for preserving food-stuffs. The artificial parchment business nowadays has little to do with papers that do not contain plenty of mechanical pulp. These must have the qualities above recited at least to a sufficient extent to pass muster with the customer.



## Irregularities in the Sulphite Digesting Process and Their Causes

By P. Klason

*Specially Translated for Pulp and Paper Magazine from "Teknisk  
Tidskrift," by C. E. Bandelin*

A theory for the digesting of wood according to the sulphite method would seem to be rather superfluous, as sulphite cellulose now has been manufactured for many years without hardly any theory. It is evident, however, that if it is desired to evade the irregularities often occurring during the digesting process, the regular course of the process must first be known, which knowledge cannot be acquired without the basis of a definite theory.

One of the most important items is the proportion between the wood and the lime in the acid, or, more accurately, between the lignine in the wood and the lime. The end of the time for digesting, according to Mitscherlich's system, is determined by adding ammoniac to a sample of the acid. The precipitate of sulphite of lime must not be too small, as the digesting must be in this case ended even if not completed. The digester men know that the acid has not contained enough lime. The acid has, on the other hand, of course, held too much lime, if the ammoniac precipitate is too great, when the pulp is ready. It is now evident that it has been just these easily controllable circumstances which have made it possible to work with, as a rule, good results, even without any theory.

The spruce wood has, as an average, the following composition:

	%
Cellulose . . . . .	53
Other carbohydrates . . . . .	13
Lignine . . . . .	29
Proteines . . . . .	1
Rosin, oil, fat, ashes . . . . .	4
	100

It is possible to prepare cellulose, nearly free from lignine directly from the barked wood and to a quantity of 52-53 per cent. by weight of the dry wood, calculated as free from ashes, if temperature and com-

position of the acid are suitably chosen. Lignine is that substance in the wood which combines with the sulphurous acid during the digesting process. For the present it may be advisable to suppose that the lignine molecule has 40 carbon atoms and this from the same reason that gives the cellulose the formula  $C_6H_{10}O_5$ . It is, however, very probable that the lignine is not an individual chemical substance, though it is at least for the present practical to regard it as such.

According to the theory and supposing that the wood contains 29% lignine, which cannot be more than 1% out of the way, 1 kg. dry wood should combine with 105.6 gr.  $SO_2$  and 45 gr. CaO during the digesting process. In reality about 100 gr.  $SO_2$  combine with 1 kg. of wood, if there is an excess of sulphite of lime in the acid. The  $SO_2$  is combined in two ways, viz., strongly and loosely. This is evident from the fact that the  $SO_2$ -titre is decreasing more rapidly than the lime-titre in the beginning of the digesting process. In the end the relation is reversed.

Irregularities in the digesting are usually caused by the formation of sulphuric acid, which combines with the quantity of lime required for the neutralization of the ligno-sulphonic acid formed. It is, therefore, very important to find out all possible causes for the formation of sulphuric acid in the digesting, as it not only makes a corresponding quantity of sulphurous acid and lime ineffective, but even can cause a whole charge to be spoiled, or, at least, that the percentage of first-class pulp decreases, which has an economically poor result as its consequence. Result is that the percentage of ashes in the pulp increases.

In the beginning of the sulphite industry it was supposed that the action of the sulphurous acid was mainly reducing, and that, consequently, the formation of sulphuric acid and gypsum were normal



occurrences. This was, however, later found to be incorrect and the formation of gypsum is very insignificant in a normal cook. An overcooking of the pulp can be caused by the formation of gypsum and lack of lime during the digesting, as will be seen in the following sample of a "burnt" cook.

The charge consisted of 65 m<sup>3</sup> chips and 83 m<sup>3</sup> acid. The acid tested 3.40% total, 2.10% free SO<sub>2</sub>, and 1.08% CaO, consequently 61.7% free of total SO<sub>2</sub>. The experience has shown that the most favorable results are obtained when the free SO<sub>2</sub> amounts to about 70% of the total. It is, therefore, evident that cautiousness must be observed as to the temperature of digesting with an acid of the composition stated. The percentage of lime in the acid decreased during the digesting with 54.86%. The cook was spoilt, overcooked. In the waste lye were contained 404.6 kg. lime. The dry weight of the wood was estimated to be 330 kg. p. m<sup>2</sup>. Consequently the charge was 21450 kg. wood.

Per. 1 kg. wood there was in the acid before the digesting:

SO <sub>2</sub> , total .....	131 gr.
CaO .....	42.5 gr.

consequently, more than enough of lime and sulphurous acid. In the waste lye after the digesting there was pr. 1 kg. wood:

CaO in the lye .....	18.8 gr.
CaO as gypsum .....	23.7 gr.
SO <sub>2</sub> as SO <sub>3</sub> .....	27.1 gr.
SO <sub>2</sub> as free S. ....	13.5 gr.
S in free form .....	6.75 gr.
SO <sub>2</sub> combined with organic substances .....	90.4 gr.

We find from this, that lack of lime occurred at the end of the digesting on account of the formation of gypsum.

A white precipitate separated out after some time and was found to consist of sulphur. If pure SO<sub>2</sub> is used for preparing the acid and a normal cook performed with it, no trace of sulphur will be found in the waste lye. It is evident that the cause of the overcooking depended upon the formation of gypsum during the cooking, on account of which there was not

enough lime available to neutralize the lignosulphonic acid formed. This acid, which, like all sulphonic acids, is nearly as strong as sulphuric acid, discolours the pulp just as easily.

In order to ascertain if the sulphite digesting liquor changes at usual temperature, several litres were prepared from pure lime and liquid SO<sub>2</sub> and kept in closed bottles. This preparation was forgotten for some 10 years. It had then been standing partly in diffused light and partly in darkness, but never in direct sunlight. The acid had originally the following composition: Total SO<sub>2</sub>, 4.3%; free SO<sub>2</sub>, 2.4%; CaO, 1.66%, which corresponds to about 56% free of total SO<sub>2</sub>, consequently not the composition which has been found to be most suitable. The acid ought not to have contained more than about 1.45% CaO.

The acid had acquired a faint yellowish tinge after this long time, probably depending upon colloidal sulphur, and some finely crystallized gypsum was found on the bottom of the flask, but no sulphur. All the lime in the acid was precipitated as gypsum, mixed with free sulphur, when the acid was heated in a closed glass tube at the usual temperature for sulphite cooking. The acid had thus been changed during that time so that it was completely unfit for its purpose. Considerable quantities of thio-sulphuric acid, trithionic acid and dithionic acid were found in the solution. About 14% of the sulphurous acid had been transformed into these acids, besides the sulphurous acid transformed into gypsum.

The final point in the transforming of the sulphite digesting acid is, when all the lime is changed into gypsum and the sulphurous acid into sulphuric acid and sulphur. Small quantities of di- and trithionic acids are also present as residues from intermediate chemical processes. In order to find out the velocity of this reaction at 135 deg. C., the usual final temperature in the sulphite digesting process, an acid of normal composition was treated to this temperature, and it was found that after about 40 hours the reaction had continued so far that all the lime was precipitated

out as gypsum. This reaction is completed in a shorter time, if the temperature is higher, but takes place more slowly the more free  $\text{SO}_2$  is at hand in the solution. The practical sulphite man also well knows these circumstances from a dearly bought experience.

A question of considerable practical importance is, how much sulphur the acid can stand at normal temperature and time of cooking without too much gypsum being found. This question can be answered experimentally by treating the digesting acid with known quantities of sulphur during the normal time of cooking and temperature. It has been found that 200 to 250 mgm. of flowers of sulphur can be added pr. litre digesting acid without much harm being done, but that all lime is transformed into gypsum if 400 mgm. sulphur are added. It is evident from the above that no dangerous disturbances in the digesting process will be caused by the sulphur, which may come into the acid in form of flowers of sulphur from the burners, if the acid does not contain any visible sulphur. If the transforming of the sulphurous acid into sulphuric acid and sulphur occurs already in the beginning of the digesting process, before any considerable quantities of lignosulphonic acids have been formed, so can all the lime be precipitated from the acid and free sulphuric acid be formed. The wood becomes black, and even tarry substances are formed. Such "burnt" cooks were not rare in the beginning of the industry, but are now very unusual.

Selenium, if present in the sulphite digesting acid, acts in about the same manner as sulphur, consequently disassociates the acid into sulphuric and sulphurous acids and sulphur. Experiments have, however, shown that the acid is immensely more sensitive to this element than to sulphur. Already, 0.5 to 0.6 mgm. selenium added pr. litre acid in form of selenious acid has the same effect as 150 mgm. of sulphur. Selenium consequently has an effect about 300 times as strong as sulphur.\*

Both selenium and selenious acid react with sulphurous acid dissolved in water already at usual temperature. The action of the selenium, however, is not very important and such a solution separates out the selenium after some time in colloidal form and then becomes red. This circumstance can be made use of to show the presence of selenium in the water, with which the gases from the pyrites burner have been washed.

Experiments have also shown that the digesting acid is sensitive also to tellurium, and that this sensitiveness is stronger than for sulphur, but weaker than for selenium.

It has already been shown that sulphur does not cause any important disturbances, if not visible in the acid and if no dust containing sulphur can reach the acid. The relatively lower sensitiveness of the acid to tellurium and its rareness make it unnecessary in practice to have any regard to this element.

The situation, however, becomes worse when selenium is present, as already a fraction of one mgm. p. litre acid can cause disturbances in the digesting process. It can be supposed that 20m<sup>3</sup> acid are obtained from the burning of one ton pyrites, which corresponds to about 10 gm. selenium. This quantity would be sufficient to completely spoil the acid, and does not amount to more than 0.001% in the pyrites.

Several analyses have been executed and the percentage found in the pyrites has varied from 0.08 to 0.001%, but probably 0.01% may be regarded as an average. It can, therefore, be stated that the digesting acid will be spoiled if 10% of the selenium in the pyrites are brought into the acid.

Experiments have shown that selenium occurs in the combustion gases mostly as such and in invisibly finely divided form. It is, therefore, of the utmost importance when pyrites containing selenium are used to work the combustion gases as thoroughly as possible.

Tower apparatuses seem to work better than chamber systems for the preparing of the acid, as the combustion gases rise

\*This is of special interest for sulphite pulp manufacturers in the West, using Japanese sulphurs which usually contain a very high percentage of selenium. --- Translator's Remark.

rapidly and don't come in such an intimate contact with the acid as in chambers. A considerable part of the selenium present in the gases, however, probably passes through the absorption apparatuses into the air, especially when towers are used.

Burners for finely crushed pyrites have the disagreeable property of giving off dust. The selenium must during a certain stage of the combustion be liquid, and can, therefore, adhere to the dust particles and thus come into the acid. It is also a fact that the more dust is given off from the pyrites the more disturbances characteristic of selenium occur. A slow combustion, and, consequently, a lower temperature has proved to be advantageous when burning pyrites containing selenium. It is evident that the gases must have a higher velocity and, consequently, carry with them more dust, when the pyrites are burnt more rapidly. This also causes more sulphuric acid formed, which also causes disturbances though of another kind.

The researches as stated above were undertaken on account of disturbances in the digesting process, occurring in some Swedish sulphite mills and which exclusively happened when pyrites from Fahlun were used. It sometimes happened that the lime was consumed before the charge was ready so that it must be blown off after 8 or 10 hours, instead of the normal 15 hours, which is, as has been shown, just characteristic when selenium is present. The pulp became reddish, brittle and dirty.

As a conclusion the following items in the manufacture and use of sulphite digesting acid from pyrites containing selenium should be given careful consideration:

1. Formation of dust in burning the pyrites should be prevented as far as possible.

2. The combustion should be conducted uniformly and slowly so that the temperature does not become higher than necessary.

3. The combustion gases should be washed in a suitable manner in order to purify them as far as possible from dust together with sulphur and selenium.

4. Towers are better than chambers when pyrites containing selenium are used.

5. The lime in the acid should be in a right proportion to the wood.

6. The spontaneous disassociation of the acid occurs more rapidly the less free sulphurous acid is at hand.

7. The free sulphurous acid ought to amount to about 70% of the total, as practical experience has shown.

8. The acid must not contain any visible quantity of sulphur.

9. The temperature of digesting should not be too high and there should be a good circulation everywhere in the digester, so that a sufficient quantity of lime is always at hand to neutralize the lignosulphonic acid formed.

These researches have further proved that:

10. A sulphite acid of normal composition is spontaneously but slowly changed even at usual temperature and in the absence of air, with the formation of thiosulphuric acid, di- and trithionic acids.

11. This disassociation is accelerated by a higher temperature, and the final result is the formation of free sulphur and sulphuric acid together with traces of di- and trithionic acids.

12. About 150 mgm. finely divided sulphur or 250 mgm. flowers of sulphur transform all the lime into gypsum at a temperature of 135 deg. C. and during a normal time of digesting.

13. The disassociation has proceeded so far in a digesting acid of normal composition, heated to 135 deg. C. during about 40 hours, that all the lime has been precipitated as gypsum.

14. Selenium has the same kind of action at 135 deg. C. on the acid as sulphur, but is 300 times more effective, so that about 0.5 mgm. selenium p. litre acid is sufficient with normal time of digesting and temperature to decompose the acid so far that all the sulphite of lime is precipitated as gypsum.

15. Tellurium has an effect on the acid which is about a medium of the effects of sulphur and selenium at the same temperature and time of digesting.

Arsenious acid has not been found to have any influence on the acid.

## Comparison of Colors

By Dr. Von Klemperer

The use of the Kallab color-analyser is recommended for determining the changes undergone by dyeings under the action of light. By no means the smallest reason for selecting this analyser is that the num-

bers by which the Kallab designates the shades give one an idea of the color, even when the apparatus is not at hand, and because a graph could be made to show clearly any color changes.

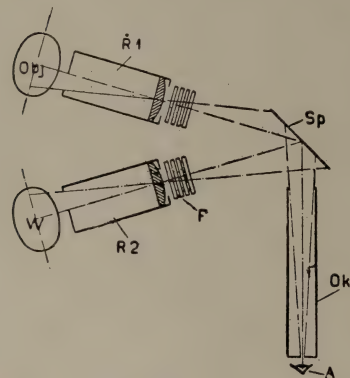

Fig. 1

bers by which the Kallab designates the shades give one an idea of the color, even when the apparatus is not at hand, and because a graph could be made to show clearly any color changes.

The writer then began researches, in conjunction with Dr. Lowe, of Jena, with the object of trying whether it was not possible to compare two shades at once, by means of the same eyepiece, and therefore under identical conditions. This cannot be done with the Kallab colorimeter head, but Dr. Lowe and the writer succeeded after many trials in constructing an apparatus in which a color to be estimated by a known one made with colored glasses can be compared with a single glance, because each of the two occupies half the field of view, and there is a sharp line of demarcation between them. The apparatus is made by Carl Zeiss, of Jena. The Kallab scales are used as a color filter, but in the form of strips instead of circles. Each strip consists of ten graduated

hues. Grey is omitted, because it can be produced by mixing equal parts of red, yellow, and blue. Referring to the Figs. Obj. and W are two circular obliquely-placed surfaces illuminated from above. The light reflected horizontally from Obj., which acts as a stretching frame for the piece of cloth, passes through a semi-circular opening into the lens-tube R1. The lens throws a sharp image of the straight edge of this opening on the screen Sp. In like manner, the light from the standard at W passes through a similar opening into R2. The two straight edge images coincide in the middle of the field seen by an eye applied at A to the tube Ok. The color filters F can be moved vertically in front of R2, and the numbers can easily be read off. The apparatus is capable of great accuracy, as all light except from Obj. and W is cut off, and as the two colors to be compared are seen on Sp simultaneously, occupying each half the field of view and separated by a sharp line.

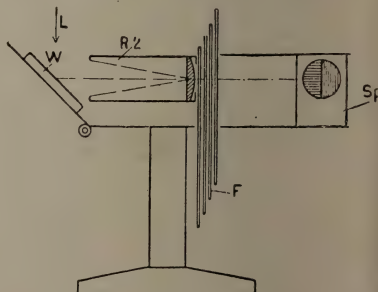

Fig. 2

The best source of light is not yet fully settled, but the light used must be as much like daylight as possible.

Hon. Clifford Sifton, chairman of the Conservation Commission, is ill with pneumonia.



## Scientific Manufacture of Sulphite Pulp\*

By Charles M. Bullard, Boston, Mass.

In the year 1884, at Rumford, R.I., the first sulphite mill in America was built and operated by the Richmond Paper Company. Since that time there have been built 102 sulphite mills in America of approximately 5,200 tons daily capacity in bleached and unbleached sulphite fibre.

To produce this enormous amount of fibre, it is safe to say that approximately 12,000 cords of wood, 1,500,000 lbs. of sulphur and 1,200,000 lbs. of lime and its equivalent in limestone is used per 24 hours, or an average of  $2\frac{1}{4}$  cords of unpeeled wood, 280 lbs. of sulphur, and 235 lbs. of lime per ton of product.

In discussing the various phases of sulphite manufacture, this paper will deal with the unbleached product only, and to determine the amounts of raw materials used on a bleached basis it is safe to add 10 per cent. to any figures given.

The most expensive raw material entering into the manufacture of sulphite pulp is wood. Its price varies greatly in different localities and under varying conditions and is steadily advancing from year to year. It is safe to say, however, that it will not average less than \$8 per cord, and that an average of  $2\frac{1}{4}$  cords is used per ton of sulphite produced. Figuring on this basis the total amount of wood used is costing the mills approximately \$96,000 per 24 hours of \$18 per ton of product.

The next expensive raw material is sulphur. Its price varies but slightly for different localities and averages \$23 per ton, therefore the mills will spend about \$18,000 per 24 hours for this material, or on a tonnage basis their sulphur is costing them \$3.64 per ton of sulphite.

Lime is the cheapest material used and its average cost is 30c. per hundred. The average amount used is 235 lbs. per ton, therefore this material is costing the mills \$3,600 per 24 hours or about 71c. per ton of product.

The users of sulphite to-day are demanding more and more as regards strength, color and cleanliness, and to meet this demand and still make a fair margin of profit the manufacturers must necessarily reduce the cost of production in every possible way, as their profit does not so much depend on the market price, which is fairly stable, as on the cost of production.

The manufacturers do not appreciate the countless ways where scientific control of every stage of the sulphite process will surely aid them to reduce this cost, and still maintain or improve the quality of production, and the sooner they realize that the old "rule of thumb method" so much in vogue in the past should be supplemented by the latest and most improved methods, the sooner they will be enabled to pay greater dividends and still compete with European manufacturers, where the cost of labor and raw material is much lower than in America, and especially in the United States.

The lack of scientific control and failure to make use of scientific methods in the average mill is the direct cause for the needless expenditure of large sums of money during the process, for such results as they are getting, both as to cost of production and quality of product, and were they to skillfully compare their operations in every stage of the process and the results therefrom with those of the few who have applied scientific methods and given them a fair trial, they would at once appreciate the value of these methods.

A very few have made use of these methods and control in their lumbering operations and by so doing have demonstrated its value. In the majority of cases, however, these operations are costing the manufacturers or operators excessively in labor, but what is of equal or more importance is the question of wood waste.

The writer has seen many instances where this waste was enormous. Large quantities of available and valuable wood in the form of stops and large limbs are

\*Paper read at the Eighth International Congress of Applied Chemistry, New York, September 9, 1912.



left scattered broadcast, which are a menace to standing timber from fire. Another large loss is due to not cutting close enough to the ground and many tons are unskillfully felled in inaccessible places where they are left to decay. These losses are mainly due to the lack of appreciation of what could be saved were these operations scientifically controlled.

In the handling, storage, and delivery of wood to and through the wood room, it is remarkable what can be done in many mills by carefully studying their individual needs and conditions. In one instance out of many, the wood room cost \$1.37 per ton. Their needs and conditions were carefully studied and various changes made in apparatus and methods, with the result that more wood is being handled with less labor and waste, at a cost of 61c. per ton, and there is still room for improvement.

A good deal of argument has come up from time to time as to which was the more economical method for barking wood, to peel it in the woods during the peeling season or at the mill by the usual mechanical method. It would seem that the former method was to be generally favored as the loss is about 9 per cent. as against an average of 25 per cent. by mechanical barking, and in many instances will run much higher.

The former method will certainly allow much more thorough and uniform drying or seasoning, which is highly important, and when the wood is delivered to the mills by rail and the freight charged by weight as is usual, we should expect a very large saving in the first cost of wood.

Wherever wood is being barked at the mill by the usual mechanical method (by the use of the ordinary disc barker) the use of scientific methods will show very large savings in wood wastes and increased capacity of wood room. Many careful tests made by weight have shown the loss during this operation to run as high as 30 per cent., when under proper conditions this should not run over 21 per cent., and in some instances even less. Such conditions actually exist, and the savings which it is possible to make are therefore very apparent.

A very recent instance of what can be done in this direction will serve to illustrate the value of proper control of the barking operations. A mill was barking approximately 200 cords of wood per day. Careful tests made by weight showed a loss of 18½ per cent. during this operation. Various inexpensive changes were made, principally by changing the speed at which the stick was turned while in contact with the barker disc, increasing the speed of the disc, decreasing the set of the barker knives, and then tests made showed the loss to be reduced to 22 per cent., or a saving of 6½ per cent., equivalent to 13 cords saved per 24 hours.

The yield per cord and quality of fibre is very largely controlled by the uniformity of chips produced, and this uniformity, as well as the amount of sawdust and sulphite screenings (which are a direct loss) are directly controlled by the conditions of the chipper, its speed and the manner of supplying the wood to it. The average amount of sawdust which is a clear loss is not less than 5 per cent. of all wood chipped, while the sulphite screenings will not average less than 5 per cent. In the majority of cases these two losses can be reduced 40 per cent. by scientifically controlling the chipping operation, which when done represents an enormous saving to the manufacturers.

Very recently a mill was chipping wood for 50 tons production. Careful and exhaustive tests were made to determine the uniformity of chips produced, and the amount of sawdust made. The amount of sawdust was found to be averaging between 6 and 7 per cent. and a slightly larger amount of coarse chips, slivers and large pieces of uncut wood were formed, which on entering the digesters with the good chips were scarcely if any affected by the acid during the cooking operation, and eventually were lost as screenings.

Careful attention was given to the condition of the chipper as regards grinding and setting of the cutting knives, face plates and bed knife. The speed was then changed and the men attending the chipper instructed as to the best method of delivering the wood to it. After these changes were made, other careful tests

showed the loss in sawdust to be reduced 51 per cent. and the large chips and uncut wood, which eventually turned up as screenings, were reduced 46 per cent. This represents a very large saving in wood and increased yield per cord.

The acid plant is the heart and nerve centre of a sulphite mill, and is usually the most neglected department. At no stage of the whole sulphite process will scientific methods and control show greater return than here.

Many manufacturers seem to think that any one who can shovel sulphur into a burner at his own discretion is fully capable of handling this very important operation economically and efficiently. They apparently do not appreciate the superiority of one type of burner over another, the requisite economy, the most efficient draft to carry on them under varying conditions, and the best method for supplying or feeding sulphur to them. Many, and I may say the majority, do not seem to realize that without proper air and temperate control in the burners, from 5 to 10 per cent. of sulphur burned may be oxidized to  $SO_2$  (nor make any attempt to determine this), which in itself is a direct loss, but later in the operation will cause still more loss in lime from the formation of calcium sulphate. This in turn causes another loss in labor, production and innumerable troubles by the plugging up of pipes, bottoms of digesters and blow-pits, and eventually shows up in the finished product.

The strength and purity of gas produced on entering the acid systems is not given the attention which it demands for the best results and the majority of mills do not even make analysis to determine this. If every manufacturer realized the importance of eliminating every air leak throughout the entire acid making system, properly controlled the temperatures during the various stages of the process, doubled and in many instances trebled the lime slacking capacity, properly introduced and distributed the digester relief in the acid storage and reclaiming tanks, with proper temperature control, they would be astonished at the great improve-

ments in efficiency and economy during the acid making process, as well as the decrease in the consumption of sulphur and lime per thousand gallons of acid made.

It is remarkable how little it takes to demoralize the acid making process which will cause the cost to go up with leaps and bounds, and still how simple and economical this process can be handled by applying scientific methods.

The cooking of wood requires the most careful and uniform control if the best results as regards maximum yield, strength and color are obtained. These results are directly controlled by pressures and temperatures carried in the digesters and manner of relief during this operation, and were the manufacturers to realize this and carry on this cooking operation on a scientific basis, very greatly improved results would be obtained.

Many do not seem to appreciate the ill effects of high temperatures, especially during the first part of the cook, and this being controlled by the relief, directly influences the retention of acid strength during the cook so necessary for the best results.

It is quite impossible to make any set rule as to the exact manner in which every digester should be handled, as conditions vary so widely in different mills, and it is therefore necessary to scientifically study their conditions and needs in order to determine what method should be followed to produce the best results. When this is done, and these methods enforced, the desired results are sure to follow.

In many mills the great variations in quality is the cause for wonder, worry and poor results. On the other hand, it is possible to remove or prevent the troubles due to this variation by applying and adhering to improved methods during the cooking process, as there is always a reason for every result obtained whether it be good or poor. The washing, handling and scouring of sulphite is usually considered a purely mechanical proposition and in a large measure this is true, but even here the scientific study of conditions and needs and application of improved methods will almost invariably demonstrate

their value in the savings in power, labor and increased efficiency, and its general adoption will be the means, and I may say is the only means of successfully solving

the many perplexing problems which are constantly coming up during the double process of the manufacture of sulphite pulp.

## Continuous Working Barking Cylinder

By Th. Fohlin

*Abstract Specially Translated from Svensk Papperstidning, by C. E. Bandelin*

One of the most important and difficult problems in the wood pulp industry is the practical cleaning of the wood from bark. A reduction of the costs for labor and the loss of wood is the object of all inventions in this department. A greater saving of wood than by barking by hand seems, however, only to be obtainable with the so-called barking cylinders. The object of this method is only to scrape off the bark made soft by the water and to leave the wood untouched. The production of the barking cylinders is besides comparatively small for wood, when the bark has not previously been thoroughly soaked by floating or suitable conditions of weather. Their charging and emptying take also a rather long time and they require a considerable amount of motive power.

These inconveniences have had for result, that this system of barking up till now has not been very widely adopted, but the increasing prices for wood have of course had for their consequence, that it has been tried to overcome the difficulties appertaining to a method, the fundamental principle of which seems so attractive.

The author had recently a chance, during a trip to the United States, to study several plants where barking cylinders were used and where different principles were applied. In the following will be shortly described a system which has been perfected and introduced in a sulphite pulp mill, belonging to The Eastern Mfg. Co. The illustration gives an idea of the management.

The wood with the bark on was cut in 4-ft. to 5-ft. lengths and submerged for at least four hours in water of about 65 degrees to 75 degrees C. temperature in a

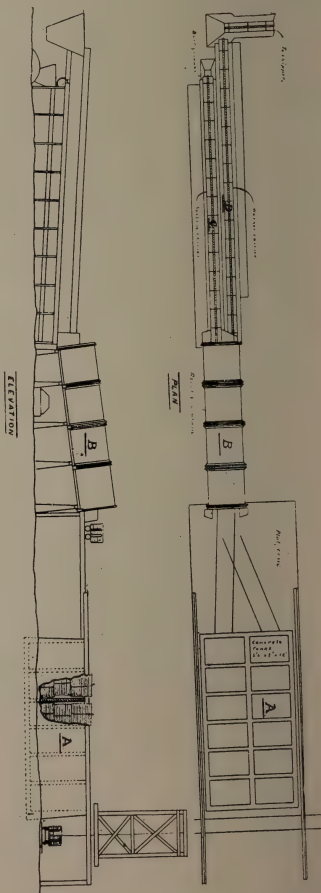

series of tanks or pits. A. It is then lifted up on a tip-car by means of a crane running over the pits and brought on to the barking cylinder B, which is a rotary cylinder of sheetiron about 40 feet long, with an inside diameter of 9 ft. 3 in. The cylinder has an inclination of about 1.6, and is open at both ends. The wood is thrown in at the upper end and passes gradually towards the lower end, when the cylinder is rotating, where it falls out on a chain conveyer. Most of the bark has then been separated from the wood; the remaining bark, which usually is easily loosened, is peeled off by hand by four or five laborers, standing along the conveyer C. After having completely cleaned the wood, they throw it on the conveyer D, which takes it to the chopping machines. The wood is energetically washed on the way to them in order to get rid of possibly remaining dirt and small particles of bark. The wood, on which the bark sticks so hard that it cannot be peeled off by hand, is barked separately on an ordinary rotary barking machine, which work, however, only requires one man.

The bark, scraped off in the barking cylinder or afterwards peeled off by hand, is then ground in a crusher and conveyed to the boiler house, where it is burnt, together with sawdust and other wood refuse.

Waste wood from a saw mill in the neighborhood was used nearly exclusively for the manufacture of cellulose in the mill in question, the yearly production of which amounted to 10,000 tons of bleached sulphite pulp. This method appears to be especially economical for wood in this form and also for wood of small dimensions, which would require much labor for the barking and cause a considerable loss of wood. But it ought to be equally suitable for wood of big dimensions, and experiments with such wood are said to have been given the most advantageous results.

The wood barking department worked only during ten hours per twenty-four, and 10 men were required. Hardly any wood at all was lost for the manufacture of pulp, except the comparatively insignificant loss caused by the final machine barking. The

cost caused by heating the water from, say, 0° to 75° C. does not exceed  $2\frac{1}{8}$  to 3 c. p. cub. metre, when the heating is effected with live steam.

#### WASHING COUCH ROLLS.

When washing the couch-roll jackets care must be taken to direct the jets from the shower-pipe against the grain of the felt, so that impurities, collecting in the felt, may be well washed out, says Papier Fabrikant. It is also advisable to apply a smooth hardwood scraper, which is normally held clear, and pressed by a weight on to the jacket only when this is to be washed. This scraper conducts to the sides the impurities removed from the jacket by the shower-pipe, and simultaneously smooths the top surface of the felt roughened by the water jets. This device can be equally well applied to both the upper and lower couch-rolls, even when a top-wire encircles the former.

When the jacket is exceptionally dirty it is, of course, necessary to wash it thoroughly with a brush and soap. For the lower jacket and the couch-rolls working with the top-wire, it is best to use a long-handled brush. The jacket is first well rubbed with soft soap, and then thoroughly cleansed with hot water and a brush made from roots (never with wire brushes).

When space permits, the lower jacket is best cleaned with the use of a strong, wide plank, on which a man can lie, and thus do the work far better than by using a long-handled brush. When changing the wire, one should never fail thoroughly to clean the lower jacket when this is not changed simultaneously with the wire. When the jackets are exceptionally dirty it is best to add a little sal-ammoniac to the washing water. After the cleansing with soap and brush, it is best thoroughly to rinse with lukewarm water, and finally wash with cold water.

The Chicoutimi Pulp Co. has entered into a contract with Edward Lloyd Co., London, publishers of the Daily Chronicle and Lloyd's Weekly News, for the supply of 50,000 tons of pulp annually for ten years.



## Effects of Beating

One hundred and fifty years ago, or more, early workers in the industry could afford the time to cut up rags by hand, or with machines of primitive construction. Such rags, whether linen or hemp, were submitted to a preliminary rotting process for conversion into paper. To produce sufficient material for the work of one vat for a day, from 36 to 48 stamps had to be kept working for 24 hours. This would yield about 60 kilogrammes of paper. Putting the necessary power required for one stamp at 10 horse power we may reckon 240 horse power hours for one cwt. of paper. Such an expenditure of time and power puts the use of stamps nowadays out of the question, quite apart from the deafening noise and manual labor necessary. We must, however, admit that the old manufacturers knew how to make good paper.

If we isolate some of the individual flax cells and fibres from these old papers and examine them more closely under the microscope, contrasting them with the long flax fibre with its round section, we shall find that in many cases they are much altered in appearance. Thus, whereas the flax fibres are mostly straight and firm, though sometimes also soft and bent, with a dark line down the middle resembling a glass tube, the fibres isolated from the paper are flattened in places, scored, split, and the end frayed out like a brush. Portions split off from the fibres may also be found which play a useful part in knitting together and filling up the interstices between the solid portions of the fibres. On the flax cells certain slanting lines may be seen which are due to the residue of the cambium cells.

The flax cells have the property of splitting and separating longitudinally, or radially, if section of the cell be taken, when submitted to powerful beating by means of stamps. This property, termed "cleavage," is possessed to a high degree by flax fibres. The numerous fibre particles split off in the process have been termed by the author "fibrils."

Ordinarily, with the best papers, but a small proportion of the fibres are split up in this manner. With the old German stamps fitted with smooth iron plates, the fibres were split up in this way, yielding a wet beaten stuff. Only by means of stamps fitted with sharp-edged steel nails, and with rags which had already been allowed to decompose and get thoroughly rotten, could a free beaten stuff be obtained. In this way, by varying the type of stamp and the duration of the process—further, the amount of pulp in the holes or pits into which the stamps descended, and the dilution of the pulp in these pits—the pulp could be obtained in almost any desired condition, which sufficiently explains the varying qualities of such old papers as are to be met with.

In contrasting linen pulp from paper prepared by the old stamping process and that produced in the ordinary beater engine of to-day, the same characteristically built fibres are met with. On closer examination of the latter, those fibres which have been partially preserved whole, and only spread or frayed out in places, are seen to have distinct spiral markings. Here we have to deal with cotton fibres, which, since the introduction of cotton into Europe, are found in all linen rags, and from which no amount of sorting can separate them. With this exception there is nothing to distinguish a pulp made with the old stamping machines and one made—far more rapidly, of course—with the modern beating engine.

For the purpose of examining the effect of stamping on various fibres, portions of moist half-stuff were beaten with a pestle in a small porcelain mortar. The stamping operation was carried on as uniformly as possible, both as regards force employed and the time taken. It was observed that the effects produced on the fibres were identical with that obtained by the old stamping process or by the modern beaters supplied with half-stuff. The tests were, of course, made microscopically, and on portions of the material mounted in glycerine or gelatine and glycerine, either stained or unstained with methyl violet.



The investigation showed that the bast fibres—linen, hemp, and jute—could be easily and completely split up. The cleavage planes were found to be radial, and also in the concentric rings. On continuing the stamping treatment, whole lengths of fibres were split up and not merely the ends frayed out, and numbers of split-off portions were obtained. The pointed ends of the fibres did not split so readily as the rest. At the same time the peculiar knots and cross-markings characteristic of linen and hemp fibres gradually disappear. No difference could be detected in the behavior of linen and hemp fibres.

On the fibres from good modern rag papers the tendency to cleavage is apparent, while in good bank and post papers numerous split fibres can be found. The cleavage was carried further than in any other with an Arabian paper of the eleventh century, and was also very apparent in papers of the fourteenth century. Still, in both these periods papers are to be found containing fibres cut into short lengths, pointing to a variety in the treatment of rags at these early periods. If the stamping is carried to the utmost limit, the fibres are converted into a mass of fibrils which present a cloudy appearance as of a confused mass under the microscope.

We have thus clearly rendered the three stages of disintegration which correspond to the modern methods of beating: (1) free beaten stuff in which the fibres are cut up with sharp knives; (2) fine beaten stuff consisting of cut-up fibres of which the ends are frayed out and split up into tufts of fibrils; and (3) wet beaten stuff in which a portion of the fibres are split up entirely into fibrils which form a confused and tangled mass between those fibres which have been preserved intact.

Those who are not continually working with the microscope should be warned not to expect to see these. Even in very wet beaten stuff, although some of the fibres are reduced to a mass of indistinct debris, some remain hardly affected at all and almost perfect. Even with wet beaten transparent paper it suffices if a sufficient proportion of the fibres be reduced to a pulpy

mass in which the better preserved ones are embedded.

With respect to jute, although the dimensions of the fibre are different from those we have been considering, yet it also shows easy and complete cleavage in the direction of the axis.

As to cotton, its structure differs fundamentally from that of the bast fibres. The cavity is much larger, and the fibre may be regarded as consisting of an outer resistant layer or cuticle and an inner cell layer which is spirally constructed. These interfere with the cleavage of the fibre, and the difficulty can only be overcome after long treatment in a pestle and mortar. Split up in this manner we do not find the longitudinal cleavage of the bast fibres, but the fibrils are twisted and interlace in corkscrew-like forms. It is this spiral structure which makes it so difficult to split the fibres, and explains why the cleavage is not longitudinal. The fibrils are, as a rule, found at the end of the fibres or where the cuticle has been loosened or removed.

These fibrils or tiny portions of fibre that have been split off are coarser and finer in character, with edges less well defined than the corresponding fibrils of the bast fibres. These characters are often to be distinctly traced in stuff taken from the beater engine. These experimental results may be regarded as affording an explanation of the peculiar properties of cotton papers as contrasted with linen ones, namely, their opacity and soft feel. Where the fibres have been flattened without loosening the cuticle, both this and the inner layers of the cell become welded together into a gelatinous shapeless mass. The resistance the bottom fibres exert against cleavage explains to a certain extent the tendency it has to fall in short lengths when treated vigorously in the beating engine.

Coming now to wood cellulose, although both sulphite and soda cellulose were examined, no characteristic difference in behavior could be detected. As in the case of the cotton, the treatment in pestle and mortar produced to a certain extent cleavage of the fibres, and owing to a similar structure, viz., external resistant cuticle

and internal layers, this cleavage is limited in extent. Characteristic for the wood fibres is the less resistant nature of the cuticle, and the fibres break up into short pieces when sharply beaten, and this more readily than would be the case with cotton fibres. The inner layer of the wood fibre has the spiral structure, and yields confused and interlaced spiral fragments similar to those of the cotton fibre, but this peculiarity in the case of the former is less pronounced. By a gradual treatment in a porcelain mortar, the ends of the wood fibres show some tendency to fray out, but much less so with the cotton fibres.

On the other hand, most of the fibres are broken down, the outer cuticle is reduced to fragments, and the inner layer to a mass of fine and tangled fibrils. Several chemical wood papers were examined and showed these characteristics, in particular an imitation parchment prepared by eighteen hours' careful beating. In this a great part of the fibres were reduced to a slimy gelatinous mass of a smoky or cloudy appearance. It may be noted that the wood fibres, by adjusting the manner of the treatment in the beating engine, may be converted into a free beaten mass, chiefly owing to their brittle nature.

On the other hand, they may yield a wet beaten stuff and a transparent paper. They fail, however, to give a fine beaten material on the lines of that obtained from bast fibres, as they lack the tendency to split longitudinally into long fibrils.

Plans are being prepared for the erection of a pulp and paper mill at Iroquois Falls by S. Ogilvie and F. H. Anson of Montreal, who were the successful tenderers to the Ontario Government for the Abitibi limits. About \$50,000 will be spent at once in clearing the woods and preparing for settlement, etc. The Abitibi Pulp and Paper Mills, Ltd., capital \$3,000,000, have received letters of incorporation from the Ontario Government. A \$500,000 pulp mill, with a capacity of 100 tons daily, will be the first step, to be followed by a paper mill of 75 tons capacity.

#### ACTION OF VARIOUS SALTS ON CELLULOSE.

At a meeting of the Verein der Cellstoff und Papier Chemiker a paper was read by W. Metzger who has studied the action of solutions of salts on cellulose, experimenting with solutions of chloride of calcium, chloride of magnesium and sulphate of aluminum in such concentrations as occur in the manufacture of paper. It was found that sulphate of aluminum was completely decomposed in the presence of cellulose; the aluminum hydrate goes to the fibres, the sulphuric acid remains in the solution and combines with an organic basic substance formed from the cellulose. The paper pulp consequently does not contain any more sulphate of aluminum. The strength of the paper, therefore, usually is not hurt by any sulphate of aluminum when it afterwards is being heated. But if the quantity of aluminum sulphate is greater than usual so can the sulphate come into the paper and can then damage the strength, depending upon the extent and intensity of the heating. The action of concentrated solutions of aluminum sulphate on cellulose can become very energetic.

A percentage of chloride of magnesium, such as lately quite often occurs in certain rivers, can hurt the strength of the paper. Uniform papers were required in order to determine the strength. These were prepared in a very simple way by means of a funnel with a very fine metal cloth. The pulp was stirred up, poured into the funnel and the water let out very slowly. If very fine fibres remain for a time suspended in the water containing aluminum sulphate after the filtration, so can after some time a white precipitate be observed on the fibres, which grows slowly, and so loads the fibres that they sink to the bottom. The white precipitate consists of slimy hydrate of aluminum. By adding sulphate of aluminum to the water used for washing the sulphite pulp the suspended fibre residues were precipitated. The degree of dilution of such wash waters most suitable is different for Mitscherlich and Ritter-Kellner cellulose. The author recommends every mill to experiment with this method.

## Experiments on Rag Pulp

At the time when rags formed the only raw material for paper the preparation of the rags for beating, i.e., the maceration or decay of the rags, was important. Today this process is employed only in individual cases for special purposes, particularly for making very absorbent papers. Macerated rags require considerably more power when being beaten than raw rags. Also the water contained in pulp made of macerated rags is removed more readily, the paper shrinks less when drying and is not excessively transparent as when raw rags are employed. The disadvantages of maceration were that the strength and sizing of the paper were impaired, the yield diminished, the fibres could be completely destroyed when the decay was excessive, and in any case cost of labor for softening and turning the rags was caused, apart from the bad smell which was always noticeable. The rags were macerated as follows:

The rags were softened with water in large wooden vats or masonry troughs, firmly stamped, well covered over, and left for six to twenty-four days, according to the kind of the rags and the character of the paper to be made from them. In order to follow what took place, the following tests were made. Half fine linen rags were softened with water, firmly stamped, covered over and kept at about 50 deg. F.:

First day—In the evening a small amount of heat began to be developed; the coldness of the water in which the rags were steeped in the morning disappeared.

Second day—The soaked rags were heated somewhat from the outside, whereupon the inner heat became much more noticeable, although the hand could still be readily kept in. No sign of decomposition was noticeable.

Third day—The same as on the preceding day, except that the heat was greater.

Fourth day—When a portion of the steeped rags was pushed back a decidedly ammoniacal odor was produced and a

thick suffocating vapor which apparently covered the rags with drops of water.

Fifth day—A small quantity of a slimy matter appeared to come from the interior of the soaked rags on to the surface. The heat could scarcely be borne by the hand; the offensive odor was still stronger, but the rags were still firm, and when one endeavored to tear them offered great resistance.

Sixth day—The slimy matter was more abundant, at some parts of the surface it was substituted by a whitish flaky mould.

Seventh day—This latter appearance was prevalent everywhere, the rags were rotten and readily tore.

Eighth day—An exceedingly large quantity of small sponges had almost everywhere replaced the slime and mould. In this condition the rags could be readily beaten and supplied a short stuff. The loss of fibre amounted to 28 per cent. An attempt to beat a part of the rags after the fifth day supplied a stuff which worked up badly into paper, i.e., the paper had a very cloudy look through.

A second test was made with rags from colored hose materials. Almost the same phenomena of decomposition resulted as with the fine linen rags. After eight days the steeped mass was turned over, and signs of decomposition again occurred in the following eight days. The rags were, however, still too firm, and had to be macerated a third time in order to supply a good whole stuff. When the rags were macerated for eight or ten days more the decomposition continued rapidly and the waste amounted to 50 to 60 per cent.

The slimy matter which separates in the initial stages of the maceration from the rags occurs to a greater extent the coarser and firmer the rags are. The chemical and physical behavior of this slime are very similar to those of animal substances, occasioning the formation of ammonia. This slime led to the maceration of the rags being substituted by another more rapid progress, first in England, by bucking. A vat of pinewood with a copper bottom was used which was placed on a stove. A

wooden grating was placed inside on the bottom, and the rags plied up on it; 4 lbs. potash were dissolved for each 100 lbs. rags, the solution was poured into the vat and water was added until all the rags were covered with liquid. The rags were then boiled for three hours, washed in clean water and bleached with chloride of lime solution.

There were two additional reasons, which caused the maceration rapidly to disappear, the manufacture of powerful beating engines (hollanders) and the treatment with alkali under pressure. The resinous and fatty substances are thereby dissolved, or, at least, converted into a condition in which they can be readily washed out. In other cases the boiling is to dissolve intercellular substances and isolate the individual fibres, as well as to render them supple and soft. Lastly, the colors of colored fibres have to be destroyed, and any animal fibrous substances which may be present have to be dissolved. In all these cases the cellulose fibre itself must not, of course, be attacked.

Milk of lime, carbonate of soda and caustic soda are used as alkalis. As to the concentration of the liquors, the temperature and time of boiling, practice widely differs. These various factors must each be governed according to the case in question. Carbonate of soda acts only slowly, but also very protectively, but is not able to destroy incrustations, colors and animal fibres. It is, therefore, suitable only for fine, white, greatly worn rags. Caustic soda is used particularly when a specially powerful action is desired, but requires care, otherwise the fibres may be injured.

Milk of lime acts quite differently from soda and caustic soda. In water it forms with fats and resins insoluble salts of lime which must be prevented from settling. Also lime dissolves in water with very much greater difficulty than soda and caustic soda, the solubility decreasing with increasing temperature. Whereas in the case of soda and caustic soda the entire quantity of alkali acts at once, in the case of milk of lime only the actually dissolved lime is active, but the strength of this active liquor is constant. When lime is employed injury is not to be feared. This,

together with the low price of lime, is the reason why bucking or bowking with lime is so generally the practice.

The action of liquor is, of course, greater, the greater the temperature which is employed. When determining the temperature of boiling, the influence of the heat on the fibres must also be regarded;  $4\frac{1}{2}$  atmos. should in no case be exceeded. As a rule, 2 to 3 atmos. is used. The time of boiling will be preferably rather longer instead of working with strong liquor or high pressure. The simultaneous employment of carbonate of soda and milk of lime, of course, serves no purpose, because the fibres are thereby loaded with carbonate of lime.

As soon as the boiling is finished the liquid is run off whilst still boiling hot, in order to avoid the substances dissolved in it being precipitated when cooling and deposited on the fibres.—Papier Fabrikant.

---

Some more rational and effective method of removing the grease and dirt from soiled rags is urgently required. At present, the long and severe boiling which greasy and dirty rags undergo is far from effective, and produces an abnormal loss and weakening of the fibre. In the old days a fermentation process was employed, but it was difficult to control within limits.

---

In the manufacture of paper, cardboard, etc., lime is mixed with the pulp in the beater, preferably in the form of "lime-white" prepared from new-slaked lime, such lime not being neutralized by separately added substances. It is claimed that the lime acts both as a weighting and sizing material. An English patent has been granted on the process to O. E. Tingberg, Stockholm, Sweden.

---

Col. Burland, of the Consolidated Paper Co., Montreal, will, with his sisters, donate \$50,000 for the purchase of a site and new building for the Montreal Foundling and Baby Hospital, provided a similar sum be raised by others.



## Tests for Ground Wood

In speaking of the phloroglucine reaction as a test for the presence of mechanical wood fibres in paper, most text books on paper testing warn the novice that certain appearances may easily mislead him. Thus there are a great variety of coloring matters, among them metanil yellow, which is so frequently used by paper-makers for the production of colored or toned papers, which aniline colors are turned red by the hydrochloric acid present in the phloroglucine solution.

This reaction frequently comes up for discussion in the trade journals, and yet cases constantly occur in which paper containing no mechanical wood has been rejected erroneously on account of the presence of coloring matter.

A striking example of this kind came recently under the observation of the Royal testing laboratories. A foreign mill delivered a quantity of paper free from mechanical wood in fulfillment of a contract, and at the same time declared the paper to be prepared from chemical wood alone, without the addition of any "broke." The paper had a yellow tone produced by the addition of metanil yellow. Immediately on delivery the paper was rejected by the consignee on the ground that it contained mechanical wood. The test for mechanical he had applied himself. The mill would not admit that any mechanical had been used, and sent a sample of the paper to the official testing laboratory in its own country, but only with the result that the paper was still declared to contain mechanical. As a matter of fact, however, the paper was quite free from mechanical, as was shown by a microscopic examination. In the piece examined not a single fibre of mechanical wood could be detected. In both cases we must conclude that the red color produced by the metanil yellow had given rise to the error, even although the red color differs considerably from that produced by ligneous fibres.

A mechanical wood paper heated with a solution of phloroglucine produces a red

color of gradually increasing intensity and certain of the thicker fibres stand out from the rest as being more darkly colored. The piece of paper contains a certain fibrous appearance. A paper containing no ligneous fibres, but colored with metanil yellow, develops the red color much more rapidly and the colored paper has no fibrous appearance, but is evenly colored. Further, the color fades fairly rapidly, and becomes surrounded with a violet tinted ground, while the color produced by mechanical wood pales less rapidly, and does not show any colored margin. It is seen then that the difference in the colorations is very distinct.

If there is any doubt, however, as, for instance, with a paper which may contain mechanical, and is possibly at the same time colored or toned with aniline dye, the paper should first be moistened with a little dilute hydrochloric acid; if no color develops then any red coloration with phloroglucine will be due to ligneous fibres. If, on the other hand, acid alone colors the sheet, a coloring matter is present, and a microscopical examination must be made, as the dye stuff obliterates the usual color reaction.

Testing laboratories, in determining whether a paper contains ligneous fibre, should always proceed to a microscopical examination, as this alone is capable of yielding results free from any suspicion of uncertainty. This is necessary in order that the type of ligneous fibre may be determined on; that is, whether mechanical wood, jute, etc. Thus, should a paper contain unboiled jute, it will give a positive reaction with the phloroglucian reagent, although one cannot speak of the paper as one containing mechanical wood, as the phrase is generally understood.

---

Stetson, Cutler & Co., St. John, N.B., are said to be negotiating with the City of St. John for the purchase of Mispec pulp mill, which has been closed down for a couple of years.



## Chemical Problems in Paper Making\*

By Dr. Schwalbe

In recent years many cotton fabrics have undergone a special chemical treatment with strong caustic soda. Such "mercerised" cottons are readily distinguished by the silky lustre which the caustic soda treatment produces. He suggests that for certain purposes, paper-makers would do well to have the mercerised cottons sorted out and used separately. These mercerised rags should possess particular advantages for the manufacture of blotting papers, since the caustic treatment removes the waxy skin of the fibre and increases its absorbency in a high degree as compared with the ordinary cotton fibre.

Among the new fibres, which in recent years have appeared in the textile industry, "kapok" must be reckoned with, as it is now spun in union with cotton. Rags containing kapok have been encountered more than once in paper mills. Kapok is a highly interesting fibre, which possesses the property of making paper extraordinary spongy. It is possible that such rags would be suitable for the manufacture of blottings, and it appears most probable that they would make a good substitute for woollen rags in the manufacture of roofing felt and similar impregnated boards.

The treatment of spinning wastes, such as flax and hemp tows, as at present carried out by means of the chlorine gas bleach, seems very irrational; the process is very tedious and the yield of fibre only moderate. Systematic research should lead to some far more rational method of treatment, which would render these fibres available for the manufacture of fine papers without undue chemical attack.

Again, in the case of ordinary rags some more rational and effective method of removing the grease and dirt is urgently required. At present, the long

and severe boiling which greasy and dirty rags undergo is far from effective, and produces an abnormal loss and weakening of the fibre. In the old days a fermentation process was employed, but it was difficult to control within limits, but the lecturer believed it should be possible to arrive at the desired object by some direct chemical treatment, which would preserve the integrity of the fibre.

Dr. Schwalbe referred to the improvement brought about by the introduction of the hot grinding process for mechanical wood pulp, and suggests that by the use of some cheap chemicals the structure of the woody tissue might be still further loosened, so as to give, on grinding, a smaller consumption of power and a better preserved fibre. It has long been known that steaming produces such an effect, but the results are far from satisfactory both as regards yield of pulp and color of the product.

Again, a scientific study of the sulphite process of digesting wood pulp should lead to important results. At present, the nature of the reaction at its various stages and of the product which is removed in the digestion of liquors is almost unknown. With a proper control of the digestion process it should be possible to produce a whole range of fibres of different types, and probably wood cellulose could be produced in sufficient purity to replace cotton in the celluloid, explosives and artificial silk industries. Even the best wood celluloses retain residues of incrusting matters and the removal of these either in the digester or by special separate treatment would open a new outlet for wood fibres. In the other direction, the limitation of the digestion process so as to produce fully separated fibres of a composition not far removed from that of the raw wood, would lead to increased yields and more economic production of materials for strong papers and newspapers where a fully purified cellulose is not an essential condition. The new lease of life which has been acquired by the soda pro-

\*Abstract of a paper read before the German Papermakers' Association, Strasbourg.

cess of digestion by the discovery of the kraft pulps is directly due to such a limitation or control of the destructive action of the lye as the lecturer suggests

In the matter of the utilisation of sulphite waste lyes much has been done, but more remains to be accomplished. Here also our ignorance of the exact nature of the dissolved constituents is almost complete. When once a true scientific picture of the chemical constitution of these lyes is attained, their industrial utilisation will come within sight. Proof of the truth of this statement is afforded by recent investigations on the nature of the waste lyes from soda pulps. The combustion of these matters in the regeneration of the soda was a very uneconomical method of applying them, but the discovery by chemical research of the fact that the bulk of the constituents were acids closely allied to lactic acid has led to the manufacture of a very valuable spirit from them, containing large proportions of acetone, which is employed in the nitro-cellulose industries. Other problems urgently awaiting solution in connection with the wood pulp industry are the question of the proper utilisation of highly resinous species which are not adapted to the present methods of manufacture; such investigation would proceed side by side with the study of the recovery of the resin and turpentine from these woods and their utilisation for paper sizing and in the arts. Furthermore, there is the problem of the conversion of waste wood, trimmings, branches, sawdust, etc., into pulp, the bulk of which material is now burnt to get rid of it.

In the paper mill chemical problems abound. There is the question of the influence of chemicals on the beating process. Cellulose is a colloid, and as such should be responsive in a physical sense to the action of very small quantities of chemicals in solution. The bleaching problem also has been very little studied on the chemical side; no one knows what is the exact nature of the substances removed from the pulp by bleaching, nor in what form they are eliminated. The problem of sizing still remains full of unsolved points, and chemists are not agreed

even on the simplest question of the chemical reactions, whilst the physical reactions are still more obscure. The fixation of the loading materials is also a physico-chemical problem which should repay systematic investigation. All mineral loadings, especially clay, are colloidal and readily influenced by traces of soluble salts. The question of new sizing agents is awaiting solution and the utilisation of waste resins from the rubber industry appears to be within sight. Under certain conditions engine sized paper loses its resistance to ink after storage, and the chemical causes of this loss are still unknown. In dyeing the pulp the chemical relations of the dyestuff have to be studied not merely towards the fibre, but also towards the mineral loading materials. Finally there is the problem of the clarification of the machine waste waters and the recovery of useful stuff from them; there is every probability that the mechanical process of clarification might be materially assisted by suitable chemical additions.

---

#### U. S. STOCKS OF NEWS PRINT.

According to figures presented by American Paper and Pulp Association to the Commissioner of Corporations, Washington, D.C., stocks on hand of news print paper at the end of August, 1912, were 45,988 tons, an increase of 5,547 tons over the July figure. Stocks on hand at the end of August, 1911, were 54,586 ton. It may be noted that an increase in stocks during the summer months is entirely seasonable. Production in August was 105,980 tons, an increase of 3,883 tons, this increase being largely due to the fact that there were 27 working days in August, against 26 in July. Shipments were 100,752 tons, an increase of 1,890 tons. The number of companies reporting was 51. The production was 90 per cent. of the computed normal for the month, against 86 per cent. in August, 1911.

---

Felix Salmon, a New York pulp and paper dealer, contemplates putting up a pulp mill in the Fort George district.

## Manufacture of Alcohol from Sulphite Waste Lyes

The manufacture of alcohol from sulphite waste lye has of late become a question of unusual importance to European sulphite pulp mills. The sulphite waste lye has been under experiment from the beginning of the sulphite industry with a view to utilize the organic substances dissolved from the wood and amounting to about 50 per cent. of its weight, which up till now have been regarded as valueless.

Many patented methods have been worked out, but until lately none has proved to be of much practical value. The invention of manufacturing alcohol from sulphite waste lye is, however, a method which certainly will be of great importance to the sulphite pulp industry. The sugar in the waste lye is the raw material for the alcohol, and many inventors have tried to transform it into alcohol in different ways.

Following is a description of the method patented by Wallin, which has been in use in Sweden for more than two years. This mill has vertical digesters and uses direct steam. For one charge are required 160 m<sup>2</sup> spruce chips=25 tons dry wood. From which 12 tons of absolutely dry cellulose are obtained and the waste lye contains 10.5 tons of organic substances, or 48 per cent. cellulose and 43.7 per cent. organic substances.

According to Prof. P. Klason dry spruce wood contains:—About 53.0 per cent. cellulose, 14.0 per cent. other carbohydrates, 29.0 per cent. lignine, 0.7 per cent. proteins, 3.3 per cent. pitch and fat.

The organic substances in the lye consist, according to the above, mainly of 29 per cent. lignine and 14 per cent. carbohydrates, and it is in the last named that is found the raw material for the alcohol, i.e., the saccharoses. Researches at Kopmanholmen have shown that sulphite waste lye, as an average, contained 2.1 per cent. sugar (calculated as dextrose).

Fermentation experiments with this lye, after neutralising and aerating, gave as an average 0.93 vol. per cent. or 0.74 weight per cent. alcohol. This corresponds with a degree of fermentation of 55 per cent. to:

1.69 per cent. fermentable saccharoses,  
0.52 per cent. not fermentable saccharoses (pentoses)  
in the lye. This amounts to 7.4 per cent. of the wood.

A better result is obtained in the praxis or 0.96—1.05 vol. per cent. alcohol, which can partly depend upon that the diastase transforms part of the carbohydrates into saccharose, as the yeast is prepared from malt and used without separating off the liquor.

The waste lye contained, calculated on the wood: About 2.5 per cent. xylose, 7.5 per cent. mannose, galaktose, unknown saccharose.

It is evident that these 7.5 per cent. of fermentable saccharoses are derived from the incrusting substances dissolved, as they are not derived from the cellulose. From tests, it is made evident that the degree of fermentation is higher than 55 per cent. of the fermentable saccharoses present. It may also be added that more alcohol is obtained at temperatures between 30° and 33° C. This fact confirms the presence of mannose, which is not fermented under 30° C.

About 9 cubic metres of waste lye per ton of sulphite cellulose are obtained at the Kopmanholmen sulphite mill. As an average this lye has the following composition:

Dry substances . . . . .	13.50 per cent.
Organic substances . . . . .	12.07 “
Total sulphurous acid . . . . .	0.23 “
Fermentable saccharoses . . . . .	1.69 “
Non-fermentable saccharoses . . . . .	0.52 “

However, only 7 m<sup>3</sup> of the waste lye are obtainable for the alcohol manufactory.

### Neutralisation of the Lye.

The free sulphurous acid and all substances which could impede the fermentation must be made harmless in order to make the lye suitable for the fermenting process. The sulphurous acid, especially when present in noticeable quantities, acts as a killing poison on the yeast cell. The

free sulphurous acid is eliminated by treating the lye with carbonate of lime (chalk, waste lime from sulphate mills, lime from the saturators in sugar factories). Also some caustic lime is added in order to complete the neutralisation, and to precipitate part of the organic substances, the lye must not be alkaline, but is kept faintly acid. The lime is added after the lye has been treated to 85°-95° C. 11.13 kg. CaO are required per m<sup>3</sup> lye. The waste lye contains only 0.23 per cent. sulphurous acid, which can be found by titration with iodine, for the neutralising of which only about 2 kg. CaO per m<sup>3</sup> would be required. Instead, five to six times this quantity is now required, which shows that the lime combines also with the sulphurous acid in combination with the sulphonic acid.

#### Graduation of the Lye.

This process has two purposes, viz., to aerate and to concentrate the lye. The object of aerating is to oxidise substances in the lye and the fermenting process does not run smoothly without aerating. The concentration is a consequence of the cooling off of the lye to the temperature suitable for the fermentation. The neutralised lye with a temperature of 85°-95° C. is therefore pumped over a graduating apparatus and circulates there until the temperature has sunk to 30°-35° C. Then about 10 per cent. of the lye should have been evaporated theoretically, but in the praxis only an evaporation of 2.5-8 per cent. is obtained.

#### Separation of the Lime.

The lime sludge obtained is separated out after the graduation in any suitable manner; the clear lye is now ready to be fermented and is brought into big fermenting vats containing 35 m<sup>3</sup>. The lye now contains:

Dry substances .....	13.89-11.96	per cent.
Organic substances ...	12.09-10.30	“
Sugar (as dextrose)...	2.39-2.26	“
Fermentable sugar ....	1.83-1.74	“

One to two per cent. of the organic substances are eliminated during the graduating and aerating processes. Some volatile

organic substances are also formed during the sulphite digesting process; for instance, cymol, methyl-alcohol, and acetone. Part of these remain in the lye and an analysis gave:

Methyl-alcohol .....	0.04	per cent.
Acetone .....	Traces.	
Cymol .....	Traces.	

These substances are afterward found as impurities in the alcohol distilled after the fermentation.

The lime sludge obtained at the neutralisation holds as an average 40-45 per cent. water. An analysis gave as an average after drying at 100°C.:

CaSO <sub>3</sub> + 1H <sub>2</sub> O .....	79	per cent.
CaSO <sub>4</sub> .....	3.6	“
Organic and not determined..	17.4	“

For every m<sup>3</sup> waste lye are consequently reclaimed 40-45 kg. lime sludge, containing about 60 per cent. CaSO<sub>3</sub>.

Eleven to thirteen kg. CaO are added per 1 m<sup>3</sup> and 16-18 kg. are obtained in the form of lime sludge.

#### Preparing of the Yeast.

The quantity of yeast added must be proportionate to the big quantities of lye to be fermented, in order that the fermentation may be completed within a reasonable time. In beer breweries 0.2-0.4 litre of yeast is used per hectolitre liquor. It is advisable to use this quantity for the fermentation. The expense would be not considerable if the surplus of yeast obtainable from the beer breweries could be used. This kind of yeast is, however, not suitable, but a special yeast, cultivated for the purpose, is used.

For preparing the yeast the pure culture is put in vessels, each containing 50 litres, and malt extract is first used as a nutritive agent. Prepared sulphite lye is afterward added, and the yeast is developed during twenty-four hours, and then transferred to a tank containing 2 m<sup>3</sup>, where more prepared sulphite lye is slowly added. The lye has fermented to about two-thirds after twelve hours. The yeast, thus so to say acclimatised, is then brought into the fermenting vats.



### The Fermentation.

The prepared sulphite lye is about 27° C. hot when it comes into the fermenting vats and is kept at this temperature for the first twenty-four hours. The vats are successively filled to 10-20-30 m<sup>3</sup> and a weak current of air is blown through the liquor. The fermentation usually is strongest during the third day, and is completed after four to six days.

#### Results of the Fermentation.

	Per cent. of Alcohol.	Per cent. of Extract.	Temper- ature. Balling.	Deg. C.
— . . . . .	—	—	13.6	27
After one day . . .	0.2		13.4	27
After two days . . .	0.45		13.0	29
After three days . .	0.70		12.6	31
After four days . .	0.85		12.4	32
After five days . . .	0.95		12.3	32
After six days . . .	0.98-1.15		12.2	32

No nutritive salts or extracts for the yeast have been added. The substances dissolved from the wood, the ashes and the proteins are sufficient to give the yeast the nutrition required. The result will be less favorable if the fermentation is driven quicker.

#### Separating Off the Yeast.

The yeast is increased five to ten times during the fermentation. The yeast formed is separated off and used again for the fermentation, after having been cultivated with malt extract during 12-24 hours. It is easy to prevent infection. Pipes and vats are sterilised with hot lye directly from the digesters.

The sulphite lye, treated as described above, is now ready to be distilled, and give up to 1.2 volumes per cent. of alcohol.

#### The Distillation.

The raw alcohol contains together with other substances:

Cymole . . . . .	About 0.4 per cent.
Methyl-alcohol . . . . .	3.4 “
Acetone . . . . .	0.5-1 “
Acetaldehyde . . . . .	Traces.

The mechanical devices in a sulphite alcohol factory are very simple. The lye is conveyed by the pumps to tanks and vats. Pipes are placed in the fermenting vats

for pressing in sterilised air and also heating coils. The lye discharged from the digesters circulates through the heating coils. Consequently no expenses are incurred for heating during the fermentation. Separators separate out the yeast formed.

#### The Distillation Apparatus.

The fermented lye arrives into this apparatus after having passed first through special economisers, which utilise the heat both from the raw sulphite waste lye and from the lye after the alcohol has been distilled off. In this way only 9-10 kg. steam was used at the Kopmanholmen alcohol factory per 100 kg. fermented lye, and an alcohol with 92-93 per cent. was obtained.

#### The Sulphite Lye After the Distillation.

The only change which the lye has undergone is that the fermentable sugar has been eliminated. The pentoses and the ligno-sulphonic acid remain. All industry aims to use up its raw materials, so that no valuable by-products remain. Still there remains, however, about 8 per cent. of the organic substances in the lye to utilise. The sulphite cellulose industry did not reach the culmination of its economical development before this was effected. A patent has lately been granted on a method to prepare hydrocarbons of the formula C<sub>6</sub>H<sub>6</sub> or multiples thereof from carbohydrates. The raw material for this process will then probably be the carbohydrates contained in the waste lye. It should be possible to prepare rubber, turpentine and other polymeric hydrocarbons in this way.

#### Polluting of Rivers by the Sulphite Lye After the Alcohol Distillation.

The sulphite waste lye is naturally less obnoxious to let out in rivers and lakes after the elimination of the fermentable carbohydrates. About 2 per cent. of the organic substances have been eliminated, and this 2 per cent. can be regarded as the most obnoxious.

#### Calculation of the Cost of Manufacturing Alcohol from Sulphite Waste Lye.

(The figures given are based on results obtained at Kopmanholmen alcohol factory.)



Alcohol factory at a sulphite mill with a production of 12,000 tons of sulphite pulp per year:

A. 720,000 litres, 100 per cent. alcohol, with a consumption of 6 m<sup>3</sup> lye taken per ton sulphite pulp.

B. 840,000 litres, 100 per cent. alcohol, with a consumption of 7 m<sup>3</sup> lye taken per ton sulphite pulp.

	A dols.	B dols.
Wages, twelve men at 320 dols. per year .....	3,840	3,840
Steam, 0.533c. per 1 litre, 100 per cent. alcohol .....	3,840	4,480
Power, five-eighth 40 h.p., at 26.67 dols. . . . .	1,067	1,067
Yeast . . . . .	1,920	2,240
Interest and amortization, 10 per cent. on 44,440 dols. . .	4,444	4,444
Management, oils, commissions, etc. . . . .	5,333	5,333
<b>Total . . . . .</b>	<b>20,444</b>	<b>21,407</b>

A. 2.83c. per litre, 100 per cent. alcohol.  
B. 2.53c. per litre, 100 per cent. alcohol.  
The expense for steam and power will, of course, be more (comparatively smaller) for larger plants, as will the cost of the yeast, particularly for the labor.

If the profit from the reclaimed sulphur and lime, which can be calculated to about 1.6-1.87c per litre alcohol, is also taken into consideration, so will the actual cost of manufacturing only amount to about one cent per litre, 100 per cent. alcohol.

The Ambursen Hydraulic Construction Company, of which Mr. G. R. Heckle, Montreal, is Canadian manager, have secured the contract for the entire construction of the Donnaconna Paper Co.'s plant at Donnaconna, on the Jacques Cartier River. The mill is to be of 100 tons capacity. The work on the plant includes a dam of Ambursen type, 1,200 feet long and from 35 to 40 feet high, as well as buildings, power plant, etc. The construction commenced last week, and, according to contract, must be completed within a year.

**FINNISH PAPER INDUSTRY.**

Taken as a whole, the paper industry in Finland registered a noteworthy development in 1910. The number of establishments was increased 7.1 per cent., the number of hands employed 8.8 per cent., and the value of the production 15.7 per cent., amounting now to 63,513,600 marks (\$12,258,125). The number of mechanical pulp mills was 43, or the same as the preceding year, but the number of hands employed by them as well as their production increased, the latter by 1,929,800 marks (\$372,451), or 13.5 per cent. The number of chemical pulp mills was 17, being an increase of 3. The number of employees rose from 1,514 to 2,620 and the value of their production from 15,612,000 to 19,042,300 marks (from \$3,013,116 to \$3,675,164). The paper mills increased in number from 24 to 27, but the workmen decreased by 584. The value of their production was, in 1909, 22,250,800 marks (\$4,294,404) and, in 1910, 25,530,900 marks (\$4,927,464).

The development of the mechanical and chemical pulp mills, the mill board works, and the paper mills will be seen from the following figures:

Workmen.	—Value of production—		
	Marks.	Dollars.	
1885	2,058	9,024,400	\$1,741,709
1895	4,119	16,622,200	3,208,085
1905	9,117	40,924,200	7,898,371
1909	9,862	52,569,400	10,145,894
1910	10,904	61,224,900	11,816,406

The following machines were used: 287 grinding machines, 63 pulp boilers, and 53 paper machines, of which 52 were "Langsieb" (Fourdrinier) and 1 "Rundsieb" (cylinder) machines. The largest working breadth was 330 centimeters (130 inches).

**LESSENS PAPER EXPANSION.**

Is it possible to make paper super-calendered and not have it expand? To make a paper that will not expand on being super-calendered is an impossibility, for the pressure of the calender rolls causes expansion of paper as it passes between them. This expansion of paper may be lessened by quick beating of the stock, making it as free as possible on the wire.

## Constituents of Spruce, Etc.

Concluded from last issue

In a paper recently published by Klason and Segerfelt (German translation in *Der Papierfabrikant*, 1911, 9, 1093), the conditions which favor the production of mercaptan have been studied. It would appear generally that the higher the proportion of total alkali employed for the digestion, the smaller is the proportion of mercaptan produced. This is explained by the fact that the mercaptan is a body with acid function which is partially converted by the excess of alkali into dimethyl sulphide, the odor of which is far less powerful. The quantities of methyl mercaptan and dimethyl sulphide therefore tend to vary inversely. Further, it is desirable that the proportion of alkali present in the form of sulphide should not exceed 20-25 per cent. of the total alkali.

The authors next turned their attention to the nonvolatile by-products derived from the wood. By evaporating the black lyes to a syrup *in vacuo*, saturating them with carbon dioxide and then heating at 110°—120° C., the lignin was separated as a gritty, fused precipitate in the form of its sodium compound, having the composition C=59.38 per cent., H=4.77 per cent., and Na=6.72 per cent. Experiments had shown that about 0.7 per cent. of methyl alcohol on the dry weight of the wood is produced during digestion by the hydrolysis of the methoxyl groups of the lignin. On the assumption that wood contains 28 per cent. of lignin and 3.8 per cent. of methoxyl, it is calculated that the lignin itself contains 13.6 per cent. of methoxyl, equivalent to 3 methoxyl groups in the molecule of lignin; thus 0.7 per cent. of methyl alcohol represents half a molecule of methoxyl split off during the digestion. Assuming further that 2OH groups have become 2ONa, the lignin molecule  $C_{35}H_{40}O_{12}$  should have become converted into  $C_{35.5}H_{37}O_{12}Na_2$ , the calculated percentage of sodium in which would be 6.2, as against 6.72 per cent. found as above.

A further quantity of lignin was precipitated in the free state by treating the liquors with sulphuric acid after separation

of the first precipitate. This first precipitate was also treated with acid to liberate the lignin and was purified by extraction with chloroform, whereby fatty and resinous acids were removed. The purified free lignin had the composition C=63.31 and H=5.24 per cent. and yielded 12 per cent. of methoxyl. From the filtrate there were obtained on distillation the volatile acids, formic and acetic, in fairly equal proportions. The residue after distillation contained lactones and lactic acids, which were separated from the salts by treatment with alcohol and ether. The results obtained by the titration of these bodies corresponded well with the assumption that they are composed almost exclusively of saccharines and saccharinic acids with 6 carbon atoms.

Calculated on 1,000 Gm. of dry organic matter in the waste lyes, the results are summed up as follows:—

	Grammes
Lignin. . . . .	542.9
Fatty and resin acids. . . . .	24.7
Formic acid. . . . .	36.9
Acetic acid. . . . .	51.6
Lactones and lactic acids. . . . .	303.4
Total. . . . .	959.5

Roughly speaking, these bodies may be taken as representing about 50 per cent. of the dry substance of the wood, since relatively high yields of cellulose were obtained.

According to Klason, the formic and acetic acids are probably derived from the pentosans of the wood gum, whilst the lactones and lactic acids would be produced by the action of the alkali upon the readily hydrolysed hexose carbohydrates.

Working independently of Klason, Rinman (*Papierfabrikant*, 1912, 10, 39 and 101) has arrived at somewhat different conditions of investigation. Rinman digested the wood with a mixture of sodium hydroxide and sodium chloride, obtaining an average yield of only 37 per cent. of cellulose; the waste liquors would therefore contain a higher proportion of products de-

rived from the decomposition of the cellulose than in Klason's experiments. The fraction described by Klason as "lignin" is termed "humus" by Rinman, who distinguishes those bodies precipitated by carbon dioxide by the name of "humus matters," whilst those precipitated by mineral acids are termed "humus acids." The sum of these two fractions always remains fairly constant, and they are apparently both derived from the same constituent of the wood, but their relative proportions vary with the conditions of digestion. Rinman states that the humus matter is not precipitated in the form of its sodium compound by treatment with carbon dioxide.

A further fraction, termed "soluble humus acids," may be precipitated as lead salts and liberated by sulphuretted hydrogen. One of the most interesting fractions of the liquors is that containing the lactic acids; these acids are combined in the lyes with 40 per cent. of  $\text{Na}_2\text{O}$ , and certainly contain a considerable proportion of ordinary lactic acid which has been isolated and characterized.

The major portion of Rinman's work is devoted to the industrial side of the question, and he has developed a new process of digestion, substituting sodium chloride for sodium sulphide and thus eliminating the mercaptan nuisance. A new method of regenerating the soda by a wet process analogous to the ammonia-soda process has been investigated, also a process for obtaining the acetic and formic acids. The most successful outcome of Rinman's work is the recovery of valuable by-products, spirits, ketones, oils and charcoal by the destructive distillation of the organic matters separated from the lyes.

---

### CORRECT USE OF CASEIN.

Casein would probably be much more generally used instead of glue if the correct manner of dissolving it had been better known. Casein is highly regarded in the paper, cardboard and especially in the coated paper industries. The best way to dissolve casein completely is to buy only the casein insoluble in water, and to

treat it in the following manner: 5 kg. casein are put in a vessel containing at least 50 to 60 litres. The casein is first washed in this vessel twice with pure water in order to eliminate any remaining acid. This is best done so, that the vessel with the casein is filled with water and the casein stirred up vigorously. The vessel is left for six to twelve hours, so that the casein may settle to the bottom, and the water is siphoned off with a rubber hose. The acid which may have remained in the casein is thus washed out. Fifteen litres of hot water are now added to the casein and the whole thoroughly stirred. Then 600 gr. borax, dissolved in 2 litres of hot water, are poured in under continuous stirring. The casein becomes rather thick and is difficult to stir up, which, however, is necessary for a thorough mixing. The stirring up and mixing are continued until no undissolved casein can be found in form of small, coarse particles and no lumps are left, and the substance has a thick, viscous appearance. This is now again left for one or two hours and afterward diluted with hot water, as required.

Casein must be dissolved with ammoniac instead of with borax when it is to be used as waterproof coating: 0.1 part (by weight) of ammoniac is taken to one part of casein, and this is mixed with three parts of hot water until completely dissolved; 0.1 part of 10 per cent. solution of formaldehyde is added to this solution after heating. This mixture is diluted with more or less hot water, depending upon the object to be coated.

Only so much casein should be taken as can be used up during ten hours and mixed with formaldehyde. The formaldehyde acts upon the casein when it has cooled off in such a way that the mixture forms a slimy and lumpy substance which cannot be used. On account of this no more of the formaldehyde mixture should be prepared than can be used in ten hours. Casein dissolved with ammoniac keeps for at least three days.

## Recent Canadian Patents Affecting Pulp and Paper Trades

No. 141034. Process of Obtaining Cellulose from Vegetable Fibres. Carl Gustav Schwalbe, Darmstadt, Germany. This improvement in the treatment of vegetable fibres with sulphite for obtaining cellulose consists in adding to the solution of the neutral sulphite an acid, the quantity of acid thus employed before the end of the treatment being not more than corresponding to half the equivalent of the quantity of sulphite used.

\* \* \*

No. 141734. Method of Preparing Paper Pulp. Harold Jackson, Garstang.

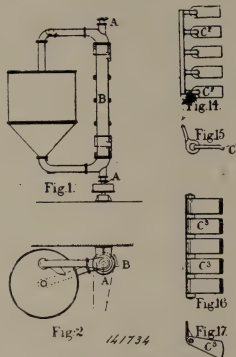

Lancashire, England. A method or process of hydrating fibres for paper making, or of preparing paper pulp which consists in subjecting the fibres while wet and mixed with water to a gentle hammering or tapping action to cause them to absorb water.

\* \* \*

No. 141089. Cellulose Manufacture. Fr. Julius Schreyer, Bremen, Germany, assignee of Josef Eduard Pfiel, Vienna, Austria. This process for obtaining cellulose consists in boiling the raw material until the encrusting substances are swollen up and removing the swollen up substances partly from the fibre, and the remaining encrusting substances being

removed from the fibre by bringing the mass into a diluted solution of permanganate, said solution being of sufficient weakness so as to prevent oxidation of the cellulose, and dissolving the encrusting substances by the addition of an acid adapted to split off sulphurous acid.

\* \* \*

No. 141529. Pulp Manufacture. Benjamin F. A. Saylor, Rome, Georgia. This process of making paper pulp from resinous woods, consists in extracting the turpentine and rosin therefrom by subjecting the wood, mixed with a small percentage of dry caustic soda, in a closed vessel, to the action of steam under a low pressure, and creating a vacuum in said vessel, whereby the air is entirely removed from the interior of said vessel, then subjecting said vessel, both on the inside and outside, to steam pressure of from 80 to 100 pounds, this action being continued for about an hour, then allowing the turpentine to escape from the top of said

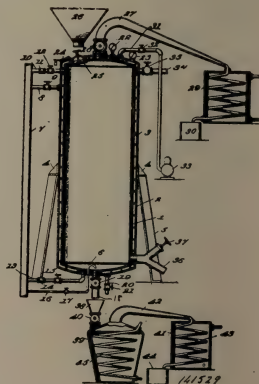

vessel, and the rosin from the bottom of said vessel, the steam pressure being still kept up, then closing the outlets from said vessel and submerging the wood in a solution of caustic soda of a strength of about 15 deg. Baume, raising the steam



pressure, both inside and outside of said vessel, to about 120 pounds, again allowing the turpentine and rosin to escape, this action being continued for five or six hours, and finally withdrawing the pulpy mass from the vessel.

, \* \*

No. 141052. Paper Making Method. Philip Weston, Dalton, Massachusetts. A method for manufacturing paper having a

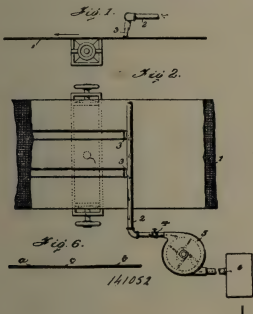

thinned portion, which consists in removing from the web at the portion to be thinned, some of the material by the application of air pressure.

, \* \*

No. 141071. Wood Pulp Manufacture.

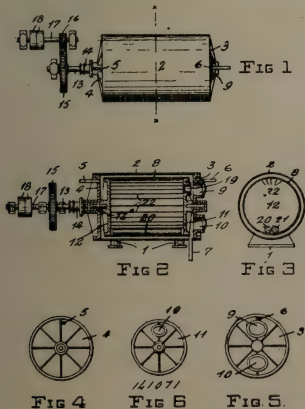

sists in placing the wood in suitable form within a revolving cylinder, simultaneously grinding and crushing the wood therein by means of suitable loose rolls, subjecting the material simultaneously to the action of a preparation of caustic soda, and applying a heating agent to the exterior of the cylinder.

**CANADIAN PAPER IN IRELAND.**

The Canadian Trade Commissioner in Ireland states that shipments of Canadian paper and pulp to Belfast direct last year totalled 481 tons, as compared with 452 tons the previous year, 505 tons in 1909 and 1,711 tons in 1908. To Dublin direct shipments last year aggregated 368 tons as against 367 in 1910, 539 in 1909, and 1,053 in 1908.

**PHILLIPS' PAPER TRADE DIRECTORY OF THE WORLD.**

The 1912 edition of this important work is no exception to the rule which has been laid down by its enterprising publisher in making it the greatest authority in the world as a source of accurate, complete information regarding the paper and allied trades throughout the world. Owing to the constant development in these industries each edition of the book calls for more and more onerous labor on the part of its compilers, and the latest affords accentuated proof of the truth of this remark, for the additions and alterations are both numerous and important. The contents include Paper Mills of the World; Wood Pulp Mills of the World; Buyers of Paper, Board and Stationery; Millboard Manufacturers; Enamellers; Paper Stainers; Paper Agents; Export Paper Shippers; Paper Stock Merchants; Wholesale Stationers, and Paper Box and Bag Makers; Registered Water Marks, with glossaries and much valuable information of a miscellaneous character. The book is thoroughly indexed, and well printed as usual. The publishers are S. C. Phillips & Co., 47 Cannon Street, London, E.C. Price 15s. 6d.

William Burton, St. John, N.B. This is a process of making wood pulp which con-



## Pulp and Paper News

H. G. Struchen of St. Paul, Minn., addressed the Board of Trade of Prince Albert, Sask., in the interests of a syndicate which proposes to establish a pulp and paper mill at that place, provided that city will grant a site and supply electric current at a fixed rate.

\* \* \*

The Ontario and Minnesota Power Co.'s new ground wood mill at Fort Frances is turning out a fine grade of ground wood, fifteen grinders being at work. One of the newsprint machines is now being installed, and it is expected that it will begin operations early in the new year.

\* \* \*

The E. B. Eddy Co.'s fine new warehouse in Toronto is now completed. It is five storeys high, of thoroughly modern construction throughout, and cost \$60,000. W. H. Rowley, president of the company, and G. H. Millen, joint general manager, made a visit of inspection last month.

\* \* \*

Sir Rodolphe Forget, Montreal, president of the East Canada Pulp and Paper Co., Murray Bay, Que., recently announced that the September interest on the \$1,500,000 bonds of that company would be paid almost immediately. The company's four new dams are now practically completed and 9,000 h.p. will be generated.

\* \* \*

The Long Sault Development Co. will renew its application for a charter for damming the St. Lawrence River near Cornwall, Ont., from the Canadian to the American side of the river. Doubtless an enormous amount of electrical energy will be generated, but the project is not looked on as being in the best interests of the country.

\* \* \*

The Spanish River Pulp and Paper Co. is making good progress in its output at Espanola. Production in August averaged 162 tons per day, a total of 4,197 tons, an increase of 263 tons over the total of July. The output of paper last month was about 100 tons daily. The Sturgeon Falls mill is operating to full capacity.

We understand that an additional \$500,000 preferred stock will be issued shortly to provide for two more machines in the paper mill and eight new grinders in the ground wood mill.

\* \* \*

The Hodge-Sherriff Paper Co. have been appointed sole selling agents for the Dominion of Canada for the Wayagamack Pulp and Paper Co., Three Rivers. Its offices are at 404 McKinnon Building, Toronto. The new mill had some little trouble for a time with its power, but is now running steadily and successfully, having recently turned out its first sheet of kraft of a very satisfactory, high quality. It is expected that the company will have considerable product to export, after supplying the home market.

\* \* \*

John G. Sutherland, of Douglas & Ratcliff, Limited, paper dealers, Toronto, has been appointed sales manager of the Spanish River Pulp and Paper Company, Espanola, Ont., succeeding E. V. Fox, who has resigned and gone to Chicago. Mr. Sutherland was formerly with E. W. Backus, president of the Minnesota and Ontario Power Company at International Falls, and with the Lake Superior Corporation of Sault Ste. Marie. He is well known to the trade in Toronto and throughout Canada generally. W. N. Hurlburt has been appointed assistant sales manager.

\* \* \*

The strike at the Kalamazoo, Michigan, paper mills is now over, the union having come to the conclusion that it could not continue the fight any longer. The men return to work under the same conditions as when they left, though some of the mills will shortly give a slight advance in wages. Five thousand hands were affected by the strike, which started on June 27th, and the mills were closed down and the windows boarded up, remaining shut until early in September, when a considerable number of men returned to work. The result has been decisive, and labor matters are likely to

remain settled in this district for some time.

\* \* \*

Mr. Carroll, formerly superintendent for the East Manufacturing Co., South Brewer, Me., has been appointed manager of the Toronto Paper Manufacturing Co., Cornwall, Ont., who are extending their plant. Mr. Carroll has had a large experience in making high-grade book and writings, similar to those turned out by the above company.

\* \* \*

The Grand Falls Company, which is to spend upward of \$8,000,000 in the development of the water power at Grand Falls, on the St. John River, N.B., and in the erection of pulp and paper mills, has made the first move in its undertaking. At the meeting of the Provincial Government an order in council was passed empowering J. K. Fleming, Surveyor-General, to convey by deed to the company the water power and five acres of land along the banks of the river on payment of \$60,000. Below the falls only one-half of the river can be conveyed to the company, the other half being held by the Crown for ordnance purposes. Sir Wm. Van Horne, president of the Laurentide Paper Co., controls the new organization.

\* \* \*

The rise in value of Laurentide shares is told graphically in the following paragraph from the Montreal Star:—Commencing at 155 in January, the market price of the shares recently advanced to 240, a rise of 85 points. On the outstanding common stock this represents an appreciation of \$6,120,000. Just a year ago the stock was listed on the reorganized two-for-one basis, and commenced selling at 145, so that in twelve months there has been an appreciation of \$6,840,000, or on the old capitalization, this means an advance in the value of the shares amounting to \$13,680,000. This wonderful property has been a veritable gold mine for the shareholders, and it is little wonder that so much attention has been attracted to the Canadian pulp and paper industry as a field for investment.

An important amalgamation was carried through recently in the merging of the Riordon Paper Co., Montreal, with G. H. Perley & Co., under the name of the Riordon Pulp and Paper Co. The G. H. Perley Co. has for years carried on a large lumber business at Calumet, L'Annonciation and St. Faustin, Que., with a total yearly output of 15,000,000 (B.M.) feet, while the Riordon Co. has pulp and paper plants at Merritton and Hawkesbury, Ont., and a saw mill at Calumet, which was burned down some little time ago, but is being rebuilt. Between them the two companies control nearly 1,200 square miles of timber limits, mostly on the Rouge River, and valued at over \$3,971,000. The new company is issuing bonds to the amount of \$1,500,000, practically covered by net current assets, excluding value of limits. Net earnings for the past three years have averaged over \$226,000. The new securities are being watched with interest by investors throughout the country. In fact, this new bond issue was over-subscribed. Extensions will be made to the Merritton and Hawkesbury plants.

---

#### SUPERFLUITY OF BOOKS.

Who is to blame for this terrible and growing superfluity of books—author, publisher, or public? Or are all alike helpless in the clutches of a business system speeding up by some dire law of evolution toward an ever-increasing overproduction? The present pace is killing, says the London Nation. In 1901 the output of new books was 5,000, enough, one might suppose, to satisfy the legitimate needs of our not wholly intellectual nation. Ten years later, however, the number had swollen to 8,500, an increase of 70 per cent. Nor does this percentage measure the full dimensions of the enhanced supply of books. For it has been coincident with a prodigious output of cheap reprints, and a general cheapening of large quantities of the new fiction and educational books.—London Exchange.

## Pulp and Paper Markets

### PULP AND PAPER MARKETS.

Toronto, Nov. 4., 1912.

Business continues uniformly good and the paper trade very busy. There has been a strong demand for newsprint and the price keeps firm. In some cases the price of book papers has been advanced again, so that present values are materially ahead of three months ago. There has been a stronger demand for kraft, while manilas and fibres are also in firmer position. Rags and mixed paper stock are scarce and high-priced.

Owing to the high water in practically all manufacturing sections, both in Canada and the United States, the demand for ground wood has declined. Mills are piling in considerable quantities, looking to a possible strengthening of demand later on. Sulphite retains its firmness in an ever-increasing degree.

\* \* \*

### MONTREAL PULP AND PAPER MATTERS.

Montreal, Nov. 2, 1912.

The pulp and paper industry has not been in as good condition for years as it is at the present time. News mills are exceptionally busy, and are all running to their full capacity. The majority of them are behind with their orders. The demand for sulphite continues very strong owing to a scarcity which seems to prevail throughout the entire country. The indications are that there will be a severe shortage during the coming winter. Ground wood which all along has been the weakest factor in the pulp and paper industry, is much improved. Prices are higher, and there is a more active demand for ground wood. In September, 22,000 tons of ground wood was shipped to the United States. The shipments of news to the United States have also increased, partly owing to the increased production of the new mills. It is said that the Americans are objecting to the increased importations, and are doing all they can

to meet the increased competition from paper manufacturers.

While very little has been said about the matter, it is known that a delegation of pulp dealers waited on Sir Lomer Gouin a few days ago for the purpose of trying to have him remove the restrictions on pulp wood exports. These local dealers were joined in the deputation by American importers of pulp wood, who assured Premier Gouin that if he would remit the restrictions now placed on the exportation of pulp wood, that they would secure the abolition of the duties on paper entering the United States. In brief, they wanted to put in force in the Province of Quebec the same kind of special legislation which they succeeded in getting passed in British Columbia in connection with the Powell River Pulp & Paper Company. It is not believed that Premier Gouin will do anything in the matter.

Quotations for paper, pulp and paper stock are as follows:

- News, \$45.00, delivered in United States.
- News, \$42.00, delivered in Canada.
- News print, rolled, \$2.00.
- News print, sheets, \$2.25.
- Book papers—Carload lots No. 3,  $4\frac{1}{2}$  to  $4\frac{3}{4}$  cents.
- Book papers—Broken lots No. 3,  $4\frac{1}{2}$  to  $4\frac{3}{4}$  cents.
- Carload lots No. 2,  $4\frac{3}{4}$ c.
- Manila B,  $3\frac{1}{2}$ c.
- Broken lots No. 2,  $5\frac{1}{2}$  to  $5\frac{3}{4}$ c.
- Carload lots No. 1,  $5\frac{1}{2}$  to  $6\frac{1}{4}$ c.
- Broken lots No. 1, 6 to  $6\frac{3}{4}$ c.
- Wrappings—
- Manila B.,  $3\frac{1}{2}$  to  $3\frac{3}{4}$  cents.
- Fibre,  $3\frac{3}{4}$  to 4c.
- No. 2 Manila,  $3\frac{1}{2}$ c.
- No. 1 Manila,  $3\frac{3}{4}$  to  $4\frac{1}{4}$  cents.
- Kraft, 4 to  $4\frac{3}{4}$  cents.
- Pulp—
- Ground wood (at mill), \$15 to \$16.
- Sulphite, \$46.00 to \$47.00, delivered in United States.
- Sulphite, \$44.00 to \$45.00, delivered in Canada.

Continued on Page xxviii.

# EMERSON MANUFACTURING CO.

LAWRENCE, MASS.

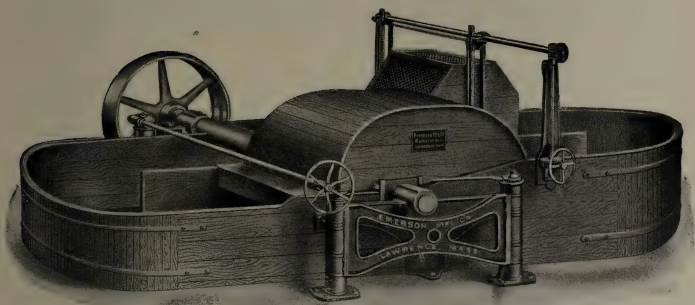

Beating and Washing Engines  
Paper Mill Machinery

**THE UNITED WIRE WORKS LTD,**  
EDINBURGH, GLASGOW & NEWCASTLE-ON-TYNE  
**FOURDRINIER WIRES, CYLINDER WIRES,**  
AND WIRE CLOTH OF ALL KINDS.

AGENTS, ARTHUR P. TIPPET & CO. 8 PLACE ROYALE MONTREAL.  
WIRES HELD IN STOCK AT MONTREAL FOR PROMPT DELIVERY.

# ARTHUR P. TIPPET & CO.

AGENTS AND IMPORTERS  
PAPER MILL SUPPLIES  
SULPHUR FELTS

SAL AMMONIAC, BORAX, SANTITIE, ETC.  
MONTREAL, TORONTO.

# Prime Canadian SPRUCE PULP

CHICOUTIMI, P.Q., - - CANADA

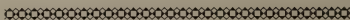

Supplied by the

**CHICOUTIMI  
Pulp Co.**

PRODUCTION:

**About 100,000 tons.**



Sole Agents:

**BECKER & CO.**

Limited.

64 CANNON ST., LONDON



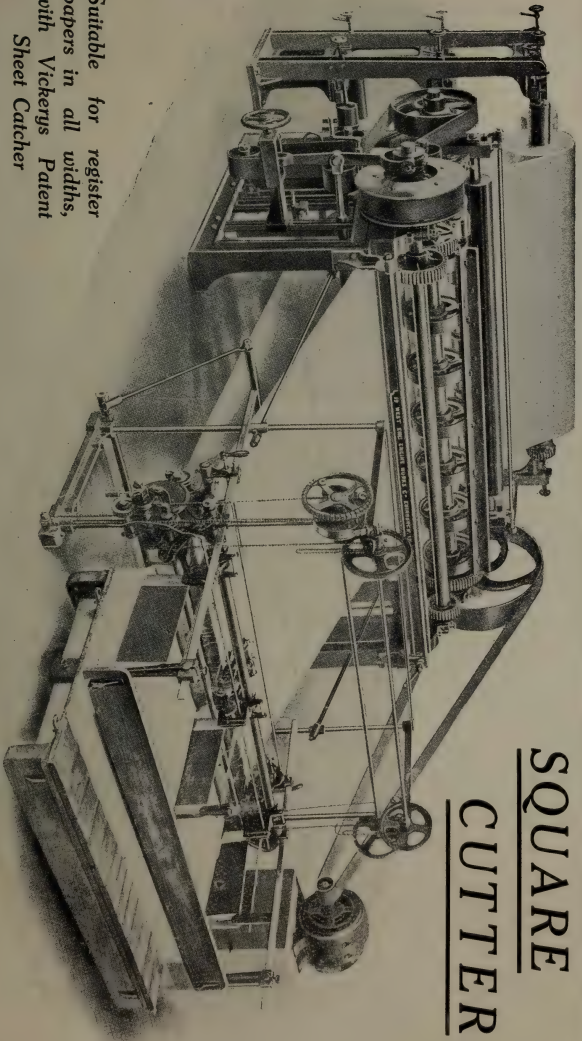

SQUARE  
CUTTER

Suitable for register  
papers in all widths,  
with Vickers Patent  
Sheet Catcher

MADE BY

THE WEST END ENGINE WORKS CO.

PAPER MAKERS' ENGINEERS

EDINBURGH  
SCOTLAND

- Sulphite (bleached), \$51 to \$53.
- Sulphite (unbleached), \$45 to \$46.
- Waste Paper, f.o.b. Montreal.
- No. 1 Hard Shavings. \$1.65 to \$1.75.
- No. 1 Soft white Shavings, \$1.60.
- No. 2 Soft White Shavings, \$1.15.
- Mixed Shavings, .45c.
- White Blanks, 80c.
- Ledger, \$1.10.
- No. 1 Book Stock, 75c. to 80c.
- No. 2 Book Stock, 35c. to 40c.
- Manilla Envelope Cuttings, \$1.00.
- White Envelope Cuttings \$1.75.
- No. 1 Print Manillas 55c.
- Railway Manillas 50c.
- Folded News, 45c.
- Crushed News, 40c.
- Good mixed Paper, 35c.
- Rags, Old and New, per 100 lbs., f.o.b. Montreal—
- Old White Cotton, \$2.50.
- Mixed Cottons, \$1.40 to \$1.50.
- Light Cottons, \$1.50 to \$1.60.
- No. 1 White Shirts Cuttings, \$5.00 to \$5.50.
- Light Print Cuttings, \$4.00 to \$4.50.
- Fancy Shirt Cuttings, \$1.75 to \$2.00.
- Blue Overall Cuttings, \$3.40 to \$3.50.
- Brown Overall Cuttings, \$2.25 to \$2.50.
- Black Overall Cuttings, \$1.65 to \$1.70.
- Linings, \$1.60 to \$1.75.
- New Unbleached Cotton, \$4.50 to \$5.00.
- Bleached & Unbleached Shoe Clips, \$4.00 to \$4.25.
- New Light Flannelettes, \$3.75 to \$4.00.
- Flock Satinets Roofing Stock, 80c. to 90c.
- Ordinary Satinets, 60c. to 65c.
- Tailors Sweepings, 60c. to 65c.

**BRITISH MARKETS.**

Reports from London are to the effect that prices for mechanical wood pulp are improving. In chemical pulp there is little change, but sellers show a very firm attitude. There is a good demand for all grades of rags.

Business in chemical is quiet for the moment, but with prices fairly strong. Bleaching powder is rather scarce, but with good enquiry. Canadian soda is in good request and firm figure. American is steady.

**THE NORWEGIAN MARKET.**

C. Sontum, Canadian Trade Commissioner at Christiania, Norway, reports:— While the heavy rains of the past month have filled the principal Norwegian rivers to overflowing, it is very significant that mechanical wood pulp, which is generally liable to go down in price during favorable water conditions, has lately hardened in price, \$9.60 now being quoted as the bottom price, and sales having been reported at higher figures. This tends to confirm the opinion, which has been ruling for some time, that the production has at last been absorbed by the increasing consumption. Cellulose is unchanged and firm. For strong sulphite \$37.33 net, f.o.b., has been obtained, and some makers are now asking \$38.67 for next year. It cannot be long before the paper manufacturers will find themselves compelled to advance their prices correspondingly with advances in raw material, coal, etc.

**NEW INCORPORATIONS.**

Richmond Paper Co. of Seattle, Wash., licensed to do business in British Columbia. Capital, \$200,000. J. H. Lawson, Jr., Vancouver.

Kuhn-Merrill, Ltd., Ottawa—To do a printing and publishing business, manufacture and deal in paper boxes and stationery. H. J. Merrill, W. J. Denison, E. F. Holcomb, of Ottawa.

Abitibi Pulp and Paper Mills, Ltd., Toronto. Capital, \$3,000,000. To manufacture and deal in ground wood and chemical pulp, paper, etc. Shirley Ogilvie & F. H. Anson, Montreal.

**The PULP & PAPER TRADING CO.**

TEMPLE COURT BUILDING, NEW YORK CITY.

DEALERS IN

**Paper and Pulp of All Kinds.**

Prices and Samples on Application.

Telephone: 2726 BROAD.

Cable Address: "LAGERLOF NEWYORK."

# Scandinavian-American Trading Company,

PRODUCE EXCHANGE BUILDING, NEW YORK,

IMPORTERS AND EXPORTERS OF

FOREIGN AND DOMESTIC

# WOOD PULP

OF ALL KINDS

AND

# PAPER MILL SUPPLIES.

HANS LAGERLÖF, PRES.

ALL KINDS OF  
Machines for Paper, Pasteboard,  
Cardboard, Cellulose  
and Pulp Mills

Paper Machines      Calenders  
Winders      Calender Roll Lathes  
Filters (Füllner's Construction)  
Cutters      Cone Refiners  
High Power Grinders      Patent Beaters  
Edge Runners

FIRST-CLASS REFERENCES

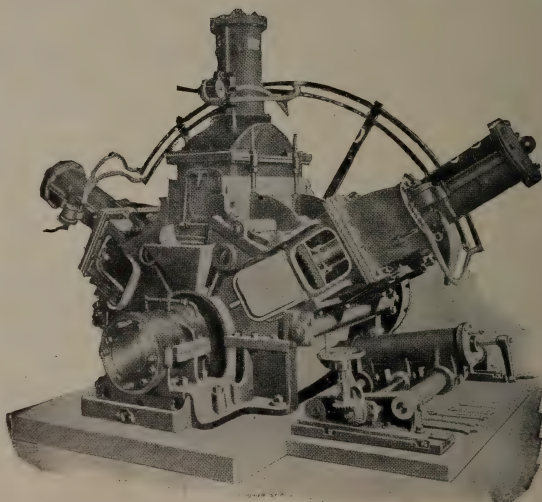

MOST MODERN CONSTRUCTIONS

Founded 1854

**H. FÜLLNER**

WARMBRUNN  
SILESIA  
GERMANY

Prizes won at all exhibitions where machines have been shown.  
Turin 1911 "Grand Prize." Paris 1900 "Grand Prix" und "Kreuz der  
Ehrenlegion." Leipzig 1897 "Gold Medaille." Paris 1907 "Grand Prix."

# CLASSIFIED ADVERTISERS' INDEX

If you fail to find what you want in these columns, write us and the desired information will be gladly supplied

## Architects and Engineers

Ambursen Hydraulic Con.  
Co.  
T. Linsey Crossley  
J. A. DeCew  
Eaton & Brownell  
Geo. F. Hardy  
Herbert S. Kimball  
International Process Co.  
Arthur D. Little, Inc.  
R. S. Lea & H. S. Ferguson  
Lyford, Clark & Lyford  
H. B. Prather  
Chas. B. Pride  
T. Pringle & Son  
Stebbins Eng. & Mfg. Co.  
R. O. and W. G. Sweezy  
Jos. H. Wallace & Co.

## Barkers.

Carthage Machine Co.  
Green Bay Barker Co.  
Jenckes Mach. Co.  
Waterous Engine Works.

## Beaters.

Dillon Mach. Co.  
Emerson Mfg. Co.  
H. Fullner  
Holyoke Mach. Co.  
E. D. Jones & Sons Co.  
Valley Iron Works  
Waterous Engine Works

## Beater Rolls.

J. A. DeCew  
J. Marx & Co.

## Belting.

Dom. Belting Co.  
F. Reddaway & Co.  
Sadler & Haworth

## Bleaching Powders.

Brunner, Mond & Co.  
Hooker Electro-Chemical  
Co.  
Winn & Holland

## Boilers.

Jenckes Machine Co.  
John McDougall Caledonian  
Iron Works

## Brass Wire Cloth, Foundriner Wires.

Geo. Christie, Ltd.  
Herman Finckh  
C. H. Johnson & Sons,  
Ltd.  
Jas. Taylor  
A. P. Tippet & Co.  
United Wire Works  
P. P. Westbye

## Camel Hair Belting.

F. Reddaway & Co.

## Calender Rolls.

Farrel Foundry & Mach.  
Co.

## Chemicals, Colors, Etc.

Brunner, Mond & Co.  
Gewerkschaft Sachtleben  
A. Klipstein & Co.  
Hooker Electrochemical  
Co.  
Paper Makers' Chemical  
Co.  
A. P. Tippet & Co.  
United Alkali Co.  
Wilson-Paterson Co.  
Winn & Holland

## China Clay.

China Clay Co.  
A. Klipstein & Co.  
C. A. Meincke & Co.  
Paper Makers' Chem. Co.  
Wilson-Paterson Co.

## Chippers.

Carthage Machine Co.  
Jenckes Machine Co.

## Conveying Machinery.

H. W. Caldwell & Son Co.  
M. Garland Co.  
Jeffrey Mfg. Co.

## Digester Lining.

Panzl Digester Lining Co.  
Preston's Digester Lining  
Co.  
Stebbins Eng. & Mfg. Co.

## Digesters.

Swenson Evaporator Co.

## Digester Gauges.

Schaeffer & Budenberg

## Drainer Bottoms.

Samuel Snell Co.

## Evaporators.

Ernest Scott & Co.  
Swenson Evaporator Co.  
Zaremba Company.

## Exporters.

Parsons Trading Co.

## Felts.

F. Bredt & Co.  
Dallyn, Jardine & Co.  
Hamelin & Ayers Co.  
C. H. Johnson & Sons,  
Ltd.  
Penman's, Ltd.  
Joseph Porritt & Sons.  
J. H. Spencer & Sons.  
A. P. Tippet & Co.

## Foundriners Wires.

(See Brass Wire Cloth.)

## Gauges.

Schaeffer & Budenberg

## Grinders.

Carthage Machine Co.  
H. Fullner.  
Glens Falls Mach. Co.  
Wm. Hamilton Co.  
Holyoke Machine Co.

Jenckes Machine Co.  
J. M. Voith  
Waterous Engine Works

## Knives.

Crookes, Roberts & Co.  
Peter Hay Knife Co.  
A. P. Tippet & Co.

## Lamps.

Gustaf Fornstedt.

## Paper Mills.

Canada Coating Mills.  
Canada Paper Co.  
New Brunswick P. & P.  
Co.  
Rolland Paper Co.  
Riordon Paper Co.

## Paper Presses.

Can. Boomer & Boschert  
Press Co.  
Jenckes Machine Co.

## Paper and Pulp Dealers.

Atterbury Bros.  
Albert E. Mallandain.  
Castle, Gottheil & Over-  
ton  
Churchill & Sim  
Howell Co.  
Parsons Trading Co.  
Pulp and Paper Trading  
Co.

## Paper Stock, Rags, Etc.

Atterbury Bros., Inc.  
J. Christie Co.  
R. Hough  
The Howell Co.  
E. Pullan  
J. R. Walker & Co.

## Paper and Pulp Mill Machinery.

Appleton Machine Co.  
Beloit Iron Works  
Bentley & Jackson  
James Bertram & Son,  
Ltd.  
Bertram's, Limited  
The Black-Clawson Co.  
Canadian Boving Co.  
Carthage Machine Co.  
Chambers & Simpson  
Dillon Machine Co.  
Emerson Mfg. Co.  
Farrel Foundry & Ma-  
chinery Co.  
H. Fullner.  
Julius Fischer  
Glens Falls Machine Wks.  
Green Bay Barker Co.  
Wm. Hamilton Co.  
Harmon Machine Co.  
J. H. Horne & Sons Co.  
Holyoke Machine Co.  
Jenckes Machine Co.  
E. D. Jones & Sons Co.  
C. H. Johnson & Sons,  
Ltd.  
Marx, J. & Co.  
Jas. Milne & Sons  
Moore & White Co.  
B. F. Perkins & Son



Rice, Barton & Fales  
 Ryther & Pringle  
 Sandy Hill Iron & Brass  
 Works  
 Ernest Scott & Co.  
 Sheldons, Ltd.  
 Sherbrooke Machinery  
 Co., Ltd.  
 S. Morgan Smith Co.  
 Stebbins Engineering &  
 Mfg. Co.  
 H. F. Storrer  
 Swenson Evaporator Co.  
 Ticonderoga Machine  
 Works  
 Valley Iron Works  
 J. M. Voith  
 Charles Walmsley & Co.  
 Chr. Wandel  
 Wandel Screen Mfg. Co.  
 Waterous Engine Works  
 Co., Ltd.  
 P. P. Westbye  
 West End Engine Wks. Co  
 Zarembo Co.

**Paper Machine Tachomet-**  
**ers.**  
 Schaeffer & Budenberg.

**Pipes (Wooden).**  
 National Pipe & Foundry  
 Co., Ltd.

**Pulp Stones.**  
 Stancliffe Estates Co.  
 Ltd.

**Pumps.**  
 Can. Boving Co.  
 Carthage Machine Co.  
 Dillon Machine Co.  
 Lawrence Machine Co.  
 Lawrence Pump & En-  
 gine Co.

John McDougall Caledon-  
 ian Iron Works.  
 Smart-Turner Mach. Co.

**Recording Gauges.**  
 Schaeffer & Budenberg.

**Recording Thermometers.**  
 Schaeffer & Budenberg.

**Rosin Size.**  
 Paper Makers Chemical  
 Co.  
 Vera Chemical Co.  
 Wilson-Paterson Co.

**Scales.**  
 Alfred H. Mardon

**Screen Plates.**  
 Union Screen Plate Co. of  
 Canada

**Screens.**  
 Glen Falls Machine Wks.  
 Harmon Machine Co.  
 Jenckes Machine Co.  
 Sherbrooke Machinery Co.  
 J. M. Voith  
 Chr. Wandel  
 Wandel Screen Mfg. Co.  
 Waterous Engine Works  
 P. P. Westbye

**Slitters and Re-Winders.**  
 H. Fullner  
 Moore & White Co.  
 Ticonderoga Mach. Co.

**Sulphur.**  
 Union Sulphur Co.

**Tachometers (Hand and  
 Stationary).**  
 Schaeffer & Budenberg.

**Talc.**  
 Geo. H. Gillespie Co.

**Tanks.**

Jenckes Machine Co.  
 John McDougall Caledon-  
 ian Iron Works

**Thermometers.**

Schaeffer & Budenberg.

**Transmission Machinery.**

H. W. Caldwell & Son Co.  
 Jones & Glassco  
 Dodge Manufacturing Co.

**Travelling Cranes.**

Hugh R. Blethen  
 Northern Crane Co.  
 Smart-Turner Mach. Co.

**Turbines.**

J. M. Voith  
 S. Morgan Smith Co.

**Water Wheels.**

Jenckes Machine Co.  
 John McDougall Caledon-  
 ian Iron Works  
 Wm. Hamilton Co.  
 Holyoke Machine Co.

**Wire Cloth for Paper Ma-  
 chines.**

Scottish Wire Cloth Co.,  
 Ltd.

**Wood Pulp Agents.**

Castle, Gottheil & Over-  
 ton  
 Churchill & Sim  
 Parsons Trading Co.  
 Scandinavian Amer. Trad-  
 ing Co.

# CALDWELL

ELEVATING, CONVEYING AND POWER  
 TRANSMITTING MACHINERY

FOR PULP AND PAPER MILLS



Helicoïd and Screw Conveyors,

Belt Conveyors.

Drag and Cable Conveyors.

Gears, Cut or Cast Teeth.

Mortise Wheels.

Shafting Bearings, etc., etc.

SEND FOR CATALOGUE NO. 34

## H. W. CALDWELL & SON CO.

CHICAGO: 17th St. & Western Ave.

NEW YORK: Fulton Building, 50 Church St.

# Samson Water Wheels

are specially suited for driving pulp mill machinery. They are durable, steady running and easy to operate, and are well adapted to direct connection to grinders.

———— WE ALSO BUILD ————

**Log Haul-Ups and Slashers,  
Grinders, Stuff Pumps, Etc.**

You have only to write for catalogues, prices or any other information you require.

**William Hamilton Company**  
PETERBOROUGH, ONT.

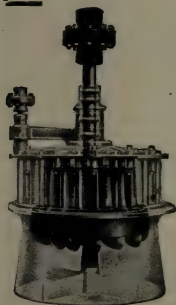

# J. H. Horne & Sons

COMPANY

Lawrence

Mass.

— MANUFACTURERS OF —

## PAPER MILL MACHINERY

Fourdrinier,  
Cylinder, and

Wet Machines.

Improved Horne Engines.

Horne Jordan Engines.

Double Bevelled Roll Bars.

Cone Pulley Cutters.

Horne Friction Cutters.

Barbed Jordan Bars.

“NEW PROCESS” CHIPPER KNIVES.

THE PERKINS IMPROVED  
PAPER STRETCH TESTER

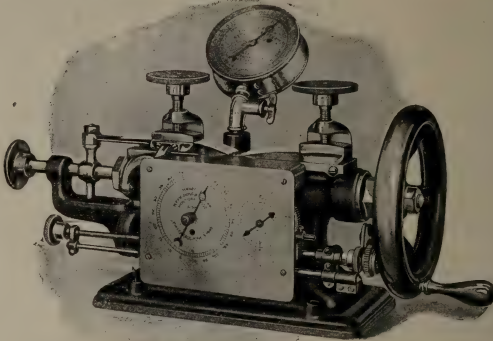

Measures the breaking strength of a strip of paper in actual pounds, and at the same time registers on a dial the amount of stretch in the hundredths of an inch. Write for special Circular and references.

B. F. PERKINS & SON, Inc.,

Holyoke, Mass.

FROZEN PULP AND DRY PULP  
IN A

Ryther Shredder

Is shredded at the rate of 5 tons per hour.  
17 to 25 H. P. required. The above figures are  
*dry weight* and absolutely guaranteed.

RELIEVE YOUR BEATERS and INCREASE QUALITY  
and PRODUCTION. Write for full Particulars.

---

Ryther & Pringle Company  
Carthage, N.Y.

# TURBINE PUMPS

SPECIALLY DESIGNED FOR

## PAPER MILL WORK

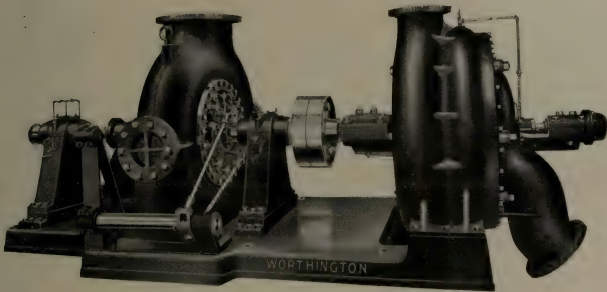

Turbine Pump, capacity 4,000  
U.S. gals. against head of 340  
feet, driven by water wheel,  
600 h.p. at 1,000 r. p. m.

**THE JOHN McDOUGALL  
Caledonian Iron Works Co.**

LIMITED

WORKS, WILLIAM AND SEIGNEURS STS. - MONTREAL

PRESTON'S

# Lining for Sulphite Digesters

TOTAL THICKNESS ONLY 2% TO 2% INCHES

Resists the action of the acid and ensures absolute protection to the Digester Plates.

Great durability, therefore large saving in upkeep and repairs.

Larger internal space and increased production on account of the small thickness occupied.

Extensively adopted by Scandinavian and Continental Mills.

Over 200 Digester Linings in work and on order.

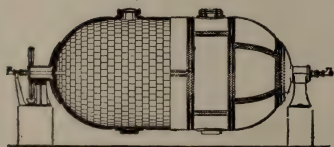
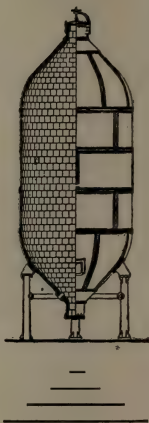

Telegraphic Address :

**"PRESTONS, RADCLIFFE."**

CODE USED A. B. C., 4TH & 5TH EDITION.

*Full Particulars and Prices on application to SOLE MANUFACTURERS*

**PRESTON'S DIGESTER LINING CO., LIMITED**

**RADCLIFFE, near Manchester, Eng.**



---

---

FARREL FOUNDRY AND MACHINE  
COMPANY

ANSONIA, CONN., - - - U. S. A.

Largest Manufacturers in the world of

**CHILLED ROLLS**

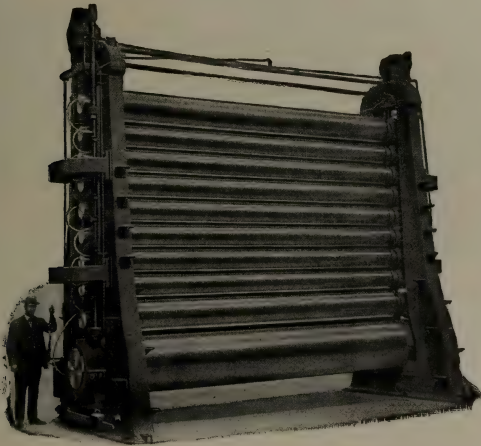

**CALENDERS**

*WITH PATENT HYDRAULIC LIFT*

**ROLL GRINDING MACHINES**

---

---

Would YOU like to enlarge your Business and find new Customers in all parts of the world? If so, ADVERTISE in

# “THE PAPER-MAKER AND BRITISH PAPER TRADE JOURNAL.”

THE LEADING AND MOST POPULAR TRADE ORGAN.

THE ADVERTISER  GOOD FOR  THE READER

We recently received the following letter:—

“We have hesitated over the matter, as we are at present so busy as to regard further advertising as almost superfluous.

“On the whole, however, we find it pays us better to have to refuse orders than to hunt after them, and will ask you therefore to insert our advertisement on same terms as last.

“We enclose herewith amended matter for advertisement, and shall be glad to have proof of same at your early convenience.”

We are constantly in the receipt of gratifying letters relative to the usefulness of our Journal, and we have pleasure in printing the following:

“Gentlemen,

We beg to advise that we have not as yet received the June number of ‘THE PAPER-MAKER AND BRITISH PAPER TRADE JOURNAL’

We like the publication so well that we should be very sorry indeed to miss a copy of it.

Thanking you in advance for your kind attention,

We are, dear Sirs, yours very truly,  
F. R. KEYES & SON,  
20 Broad Street, New York.”

## S. C. PHILLIPS & Co.'s STANDARD PUBLICATIONS

### The Paper-Maker

AND BRITISH PAPER TRADE JOURNAL.

Published on the 1st of each month. Price 1s., by post 1s. 6d. Annual Subscription 12s. 6d. post free.

**The Stationery World,  
Printing and Allied Trades,**  
AND FANCY GOODS REVIEW.

Published on the 25th of each month. Price 6d. by post 7d. Annual Subscription 5s. post free.

Chief Offices:

47 CANNON STREET, LONDON, E.C. (ENGLAND).

### The Paper Box and Bag Maker.

Published on the 19th of each month. Price 6d., by post 7½d. Annual Subscription 6s. 6d. post free.

**Phillips' Paper Trade Directory  
of the World.**

15s. 6d., post free to all countries.

NEW EDITION FOR 1911 NOW READY.

Specimen Copies and Advertisement Rates  
FREE OF APPLICATION.

# PAPER and CLOTH Specialties

*For Rent and Club Cards, Pattern Cards, Map Printing, Label Printing, Envelopes, etc., etc.*

Cloth Lined Papers. Cloth Centred Papers and Boards. Cloth Lined, Chromo and Enamel. Cloth Lined Boards and Cards (surfaced and enamelled). Cloth Centred Boards (surfaced and enamelled). Manilla Surfaced Boards and Cards.

**Also Enamelled Blotting. Art Papers. Paste Boards. Chromo and Surface Papers**

Customers' requirements in specialties are carefully considered and experiments conducted if necessary.

---

## ALBERT E. MALLANDAIN

OFFICES: 51 Cheapside  
London, E.C.

MANUFACTURER

MILLS: Park Royal  
Willesden, London, N.W.

## E. H. WILKINSON

Telephone Building  
82 Adelaide Street West  
Toronto

*Sole Agent for Canada*

Telephone Main 1716  
Cable Address: *Faultless*

# HERMANN FINCKH

REUTLINGEN

*Established 1879*

GERMANY

---

# FOURDRINIER WIRES

---

**SULPHITE - MACHINE WIRES**  
**CYLINDER WIRES**

---

**P. P. WESTBYE, - Peterborough, Ontario**

*Sole Agent for Canada*

## WANT AND FOR SALE ADVERTISEMENTS

**ENGINEER**—With head office in St. John, N.B., would like to correspond with responsible firm of pulp and paper machinery manufacturers wishing to open business in the Maritime Provinces. Apply "Reliable," c/o Pulp and Paper Magazine.

**EXPERT MANAGER** of the German Amalgamated News Paper Mills wants similar position in Canada or United States. Familiar with the news markets of Asia, Australia, South America; speaks German, French, English, Spanish, Portuguese. Kindly correspond with Erich Dickudt, W. 57 Zietenstrasse 16, Berlin, Germany.

**UNDER MANAGER.**—Young man, 14 years' practical experience in English mill making long elephants, news, all-wood printings, cream laid, etc. Experienced mill chemist—testing of papers, fibres, etc. Highest references. Address H. C., c/o Pulp and Paper Magazine.

**SWEDISH** gentleman at present in America with wide experience in Europe and this country in sulphite, pulp and paper industries, desires position as designer of or superintendent for such mill. Consumption of sulphur in last mill built, 8 per cent. Brown, steamed wood pulp and paper a specialty. Also consultations. Good references. Correspondence solicited. C. E. B., c/o Pulp and Paper Magazine.

**FOR SALE.**—Special Second-hand cylinder mould, 48-in., diameter 84-in. face. Good as new. Can be used as Filter. For particulars, etc., address Box 32, Pulp and Paper Magazine.

**MASTER MECHANIC** wants change; twenty years' experience in Canadian and American pulp and paper mills; good workman and experienced foreman. Best references. Address Box 39, Pulp and Paper Magazine.

**SUPERINTENDENT** for sulphite pulp—Mitscherlich, Ritter Kellner and combinations, tower and tank acid systems, European and American experience. Open for engagement. Apply Box 36, Pulp and Paper Magazine.

**MECHANICAL AND MILL ENGINEER**—University education, wood pulp, fibre, paper, cardboard specialist wants new engagement. Rebuilding, management, money saving improvements. Apply Box 38, Pulp and Paper Magazine.

**ENGINEER**—English, 38, with exceptional experience in the paper trade, is open for an appointment. Fully qualified, civil and mechanical training and practice. 22 years with two (only) of the largest paper makers in the country. Well up on fuel, engines, boilers, and electrical plant, and driving. Conversant with the latest paper mill methods and machinery. Can design, build, and operate a works for any output. Had very extensive experience in building and railway work, bridges, and reinforced concrete. Good organizer and disciplinarian. Apply Box 35, Pulp and Paper Magazine.

**PULP MILL CHEMIST** with twelve years' experience in Sulphite (Bleached and Unbleached), wants similar position, good draughtsman. Apply Box 30, Pulp and Paper Magazine.

As we are using all our Water Power at our Pulp Mill for electricity, we are disposing of the Pulp Mill Machinery—including Millard Patent Grinders which were in use only a few months and are absolutely as good as new, also Wet Machines, Barkers, Screens, Pumps, Piping, Shafting, Stones, etc., etc., all in good condition. Full information will be given upon application.

Apply Box "A,"  
Pulp and Paper Magazine

SCOTT'S IMPROVED RECOVERY SYSTEMS  
 FOR  
**SODA, SULPHATE & SULPHITE**

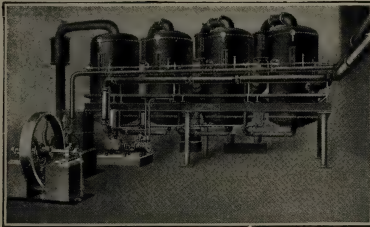

Spent Liquors give the  
MAXIMUM ECONOMY  
AND EFFICIENCY

The PRINCIPLE,  
 The DESIGN,  
 The CONSTRUCTION,  
 The OPERATION,  
 The RESULT,

**Is RIGHT**

Complete installations made by "THE FIRM WITH THE EXPERIENCE."

**ERNEST SCOTT & CO.** Manufacturing  
 Engineers

FALL RIVER, MASS. and G.P.O. BOX 2803, MONTREAL

**SODA OR SULPHATE**

RECOVERY SYSTEM  
 MAXIMUM EFFICIENCY      MINIMUM LOSSES

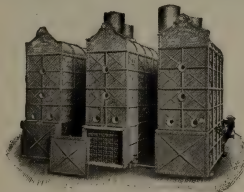

WELDED DIGESTERS      MULTIPLE EFFECT EVAPORATORS  
 AND OTHER PULP MILL EQUIPMENT

**SWENSON EVAPORATOR CO.**

945 Monadnock Bldg. . . . . CHICAGO



# SHELDON

## HEATING APPLIANCES

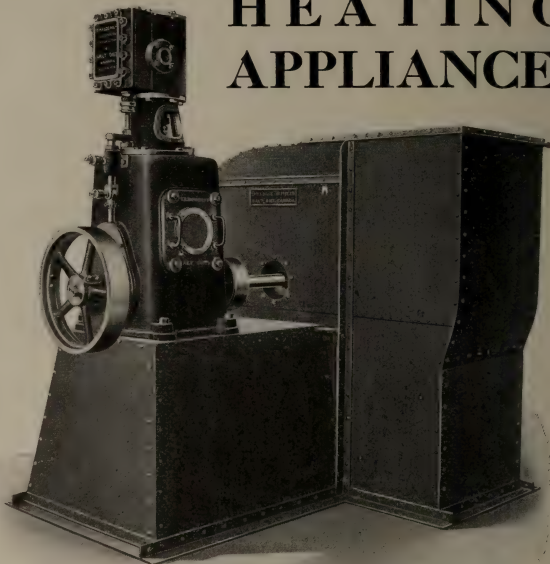

Fan, with Vertical Enclosed, Forced Lubricating Engine, for  
Textile, and Pulp and Paper Mills.  
Heating and Ventilating, Callander Blowers, Piping, etc.

**SHELDONS LIMITED**  
GALT - - - ONTARIO

Toronto Office: 609 Kent Bldg.

Agents: Ross & Greig, 412 St. James St., Montreal, Que.  
Grose & Walker, 259 Stanley St., Winnipeg, Man.  
R. Hamilton & Co., Bank of Ottawa Bldg., Vancouver, B.C.  
Gorman, Clancey and Grindley, Calgary and Edmont.n

VALLEY IRON



WORKS COMPANY

# BEATING AND WASHING ENGINES

IRON OR WOOD TUBS

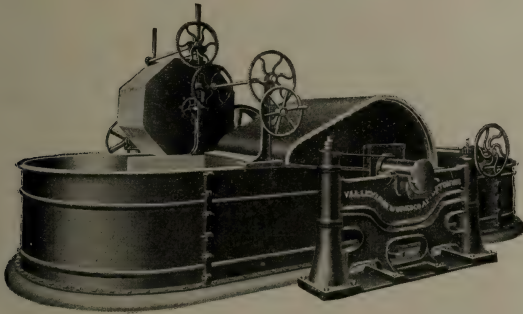

*Perfection in Every Detail*

Beating, Washing and Bleaching Engines. Barkers—Barker Attachments  
—Chippers—Rechippers—Chip Screens (Revolving)—  
Knot Screen (Revolving)—Diaphragm Screens—Felt Washers— Deckers  
(Single and Double)—Stuff Chests (Vertical and Horizontal)—  
Tanks (Blow Off, Acid and Water)—Pulpwood Saws (Friction and  
Steam Feed)—Pulpwood Splitters (Vertical and Horizontal)—  
Shredders and Special Washers for old Paper Stock—Wet Machines and  
Patent Roll Skinners—Bronze, Semi-Steel, Lead and Iron Castings.

Manufacturers of Paper and Pulp Making Machinery in

*All Standard Forms — Many Special Designs*

ENGINEERS, FOUNDERS AND MACHINISTS

*Correspondence Invited*

VALLEY IRON WORKS COMPANY

APPLETON, WIS., U.S.A.

# TOWNSEND

## ELECTROLYTIC CELL

2,500-5000 AMPERE UNITS. ALKALI AND CHLORINE.  
CAUSTIC SODA. BLEACHING POWDER. CHLORINE  
FOR ORES. LICENSES GRANTED. CANADIAN PATENTS  
91939 - 105088 - 105089.

**HOOKER ELECTROCHEMICAL COMPANY**  
40 WALL STREET, NEW YORK

REGISTERED



JOHN KNIGHT, Pres. C. K. WILLIAMS, Treas. C. H. KNIGHT Sec.

## Paper-Makers Chemical Co.

FROM MINE TO MILL

**ENGLISH CHINA CLAYS  
MANUFACTURERS**

**Excelsior Felt Cleaner**

GBB Brand China Clay is  
a natural pure white, no artificial tinting  
Unsurpassed for  
coating, bleaching, or fine papers.

Superior Rosin Size

Superior Satin White

**EASTON, PA., U.S.A.**

## Paper Coating and Colouring Machines

COMPLETE PLANTS AND ACCESSORIES

The best in the world.

To be obtained from

**Julius Fischer** Engineering Works **Nordhausen, H.**

GERMANY

*Excellent References in all countries.*

**THE PETER HAY KNIFE CO., Limited, GALT, ONT.**

MACHINE  
KNIVES,  
CHIPPER,  
BARKER &  
PAPER-  
CUTTER  
KNIVES.



Made from the Best English Steel and Warranted.

Established  
1869

**CHR. WANDEL**

Established  
1869

REUTLINGEN

GERMANY

Paper Machine Wire and Engineering Works

SOLE MANUFACTURER OF

**The Original "WANDEL" Rotary Screen**

Over  
3,000  
Apparatus  
Sold

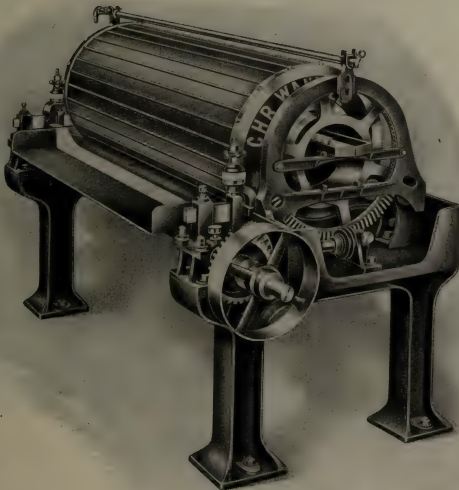

No authorized  
builder in  
Canada  
or the States

**ADVANTAGES :** *Regular output of pulp. Large working ability. Automatic removal of knots. Avoidance of stoppage. Less power. Great strength and durability. Suitable for all classes of paper.*

ESTIMATES PROMPTLY FURNISHED, DELIVERED AT ANY POINT

---

---

SOLE CANADIAN AGENTS

**ARTHUR P. TIPPET & CO.**

8 Place Royale

Montreal, Que.

# CROOKES, ROBERTS & Co.

SHEFFIELD

ENGLAND

Makers of

Makers of

Crucible Cast Steel

Bessemer Cast Steel

Bed Plates

Crookes'

Jordan Fillings

Composition

Beater Bars

Fillings



And every description of Cutter Knives, Tools and Steel used and required in Paper Mills.

**ARGUS** High-Speed **STEEL** for fine machine tools is unsurpassed.

Once Used - Always Used

YOU SAVE MONEY USING "ARGUS" GOODS

WRITE US

**ARTHUR P. TIPPET & CO.**

Agents for Canada

MONTREAL

# SPENCER'S

ALWAYS



RELIABLE

Best Wool - Best Weave - Best Wear

**J. H. SPENCER & SONS**

BURY

ENGLAND

Canadian Agents: ARTHUR P. TIPPET & CO., MONTREAL



# INDEX TO ADVERTISEMENTS.

(SEE CLASSIFIED ADVERTISERS INDEX ON PAGE XXXI.)

Ambrusen Hydraulic Construction Co. . . . .	lv	Dodge Mfg. Co. . . . .	iv
American Forestry Association . . . . .	liv	Dominion Belting Co. . . . .	xlvi
Appleton Machine Co. . . . .	iv	Eaton & Brownell . . . . .	lviii
Atterbury Bros. Inc. . . . .	lxii	Emerson Mfg. Co. . . . .	xxv
Becker & Co. . . . .	xxvi	Farrell Foundry & Machine Co. . . . .	xxxvii
Beloit Iron Works . . . . .	xiii	Ferguson, H. S. . . . .	lviii
Bentley & Jacskon . . . . .	v	Fischer, Julius . . . . .	xliv
Bertram, James & Son, Ltd. . . . .	xviii	Finckh, Hermann . . . . .	xxxix
Bertram's, Limited . . . . .	vi	Finckh, Hermann . . . . .	xxxix
Black-Clawson Co., The . . . . .	x	Fullner, H. . . . .	xxx
Blethen, Hugh R. . . . .	lix	Garland, M. Co. . . . .	xii
Bredt & Co., F. . . . .	lii	Gewerkschaft, Sachtleben . . . . .	lxiii
Brunner, Mond & Co., Limited . . . . .	lxvi	Gillespie, Geo. H. Co. . . . .	lxv
Caldwell, H. W. & Son, Co. . . . .	xxxii	Glens Falls Machine Works . . . . .	xlx
Canada Coating Mills, Limited. . . . .	lvii	Green Bay Barker Co. . . . .	xxi
Canada Paper Co., Ltd. . . . .	lvii	Hamelin, The, & Ayers Co., Ltd. . . . .	lx
Canadian Boomer & Boschert Press Co. . . . .	lx	Hamilton, Wm. Co. . . . .	xxxiii
Canadian Boving Co. . . . .	lv	Hardy, Geo. F. . . . .	lviii
Carthage Machine Co. . . . .	xxiv	Harmon Machine Co. . . . .	viii
Castle, Gotthell & Overton . . . . .	lii	Hay Knife Co., Peter, Limited . . . . .	xlv
Chambers & Simpson . . . . .	vi	Holyoke Machine Co. . . . .	xvi
Chicoutimi Pulp Co. . . . .	xxvi	Hooker Electrochemical Co. . . . .	xlv
China Clay Co. . . . .	l	Horn, J. H. & Son . . . . .	xxxiii
Christie, J. Co. . . . .	lxv	Hough, R. . . . .	lxvi
Christie, Limited, George . . . . .	lxv	Howell Co., The . . . . .	xlviii
Churchill & Sim . . . . .	lxii	Jeffrey Mfg. Co. . . . .	iii
Crookes, Roberts & Co. . . . .	lxvi	Jenckes Machine Co. . . . .	xvii
Crossley, T. L. . . . .	lviii	Johnson & Sons, Limited, C. H. . . . .	xlx
Dallyn, Jardine & Co. . . . .	lii		
De Cew, J. A. . . . .	lix		
Dillon Machine Co. . . . .	xiv		

## HYDRAULIC TURBINES

One unit of six with a total capacity of 13,100 Horse Power furnished for the new plant of J. R. Booth, Ottawa, Ontario. We build Turbines for any power for heads from 3 to 600 feet.

WRITE FOR CATALOGUE



**S. MORGAN SMITH CO.,**  
**YORK - PA.**

Jones, E. D. & Sons Co. ....liv  
 Jones & Glasco .....xx  
 Kimball, Herbert S. ....lviii  
 Klipstein & Co., A. ....1  
 Lawrence Machine Co. ....xx  
 Lawrence Pump & Engine Co. ....lii  
 Lea, R. S. & H. S. Ferguson ....lviii  
 Little, Arthur D. Inc. ....lviii  
 Lyford, Clark & Lyford ....lviii  
 Mallandain, Albert E. ....xxxix  
 Marx, J. & Co. ....viii  
 Mardon, Alfred H. ....lx  
 McDougall, John, Caledonian Iron Works  
 Co., Limited .....xxxv  
 Meincke, C. A. & Co. ....1  
 Milne, Jas., and Son .....li  
 Moore & White Co. ....xv  
 National Pipe & Foundry Co., Ltd. ....1  
 New Brunswick Pulp and Paper Co.,  
 Limited .....lv1  
 Northern Crane Works, Ltd. ....lxvi  
 Panzl Digester Lining Co. ....lvi  
 Paper Makers Chemical Co. ....xlv  
 Parsons Trading Co. ....xxiv  
 Penmans Limited .....li  
 Perkins, B. F. & Son .....xxxiv  
 Phillips, S. C. & Co. ....xxxviii  
 Porritt & Son, Joseph .....li  
 Porritt Bros. & Austin .....xlix  
 Prather, H. B. ....lix  
 Preston's Digester Lining Co. Ltd. ....xxxvi  
 Pride, Chas. B. ....lix  
 Pringle, T. & Sons ....lviii  
 Pullan, E. ....liv  
 Pulp & Paper Trading Co., The ....xxviii  
 Reddaway, F. & Co. ....liv  
 Rice, Barton & Fales .....ii  
 Riordon Paper Co., Limited ....lvii

Rolland Paper Co., .....lv1  
 Ryther & Pringle .....xxxiv  
 Sadler & Haworth .....liii  
 Sandy Hill Iron & Brass Works .....x  
 Scandinavian American Trading Co. ....xxix  
 Schaeffer & Budenberg Mfg. Co. ....lxiii  
 Scottish Wirecloth Co. ....xlviii  
 Scott, Ernest & Co. ....xli  
 Sheldons Ltd. ....xlii  
 Sherbrooke Machinery Co., Limited. ....xix  
 Smart-Turner Machine Co. ....lxvi  
 Smith, S. Morgan, Co. ....xlvii  
 Snell, Samuel Co. ....1  
 Spencer, J. H. & Sons .....xlv1  
 Stancliffe Estates Co., Ltd. ....lxiii  
 Stebbins Engineering & Mfg. Co. ....lix  
 Sweezy, R. O. & W. G. ....lviii  
 Swenson Evaporator Co. ....xli  
 Taylor, J. A. ....lxv  
 Ticonderoga Machine Works .....e.o.m.  
 Tippet, Arthur P. & Co. ....xxv-xlv-xlv1  
 Union Screen Plate Co. ....iii  
 Union Sulphur Co., The .....lx1  
 United Wire Works, Limited .....xxv  
 Valley Iron Works .....xliii  
 Vera Chemical Co. ....lxii  
 Voith, J. M. ....vii  
 Walker, J. R. & Co. ....lxii  
 Wallace, Jos. H. & Co. ....lix  
 Walmsley, Charles & Co. ....xxii-xxlii  
 Wandel, Chr. ....xlv  
 Wandel Screen Mfg. Co. ....ix  
 Watrous Engine Works Co., Ltd. ....lxiv  
 Westby, P. P. ....xi-xxxix  
 West End Engine Works Co. ....xxvii  
 Wilkinson, E. H. ....xxxix-lvi  
 Wilson-Paterson Co. ....xxv  
 Winn & Holland .....lxvi  
 Zaremba Co. ....e.o.m.

*Scandinavian Sulphite  
 and Ground Wood  
 Kraft Pulp  
 Bleached Sulphate  
 and Sulphite  
 Austrian Bleached  
 Mitscherlich*

Limited quantities still available

Write us for quotations and  
 quantities

**THE HOWELL CO.**

8-10 Wellington St. East

**TORONTO - CANADA**

**MAPLE LEAF**  
**STITCHED COTTON DUCK**  
**BELTING**  
**DOMINION BELTING CO. LTD.**  
**HAMILTON CANADA**

**The Scottish Wirecloth**

Company, Limited

LEITH - - - SCOTLAND

Wirecloth for Paper Machines, etc.

# Glens Falls Machine Works

GLENS FALLS, N.Y.



Sole Manufacturers of  
**Tromblee & Paull Rotary Sulphur Burner**  
**The Moore Rotary Screen**  
**The Reynolds Screen**

Also Manufacture

**Cedar Point Foundry Grinders**  
**Improved Standard Grinders**  
**Improved Wet Machines**  
**Rotary Pumps, etc.**

Write for Particulars and Specifications—they are free.

## C. H. JOHNSON & SONS, Ltd.

WIRE WORKS, ST. HENRY, MONTREAL.

MANUFACTURERS OF

**Fourdrinier Wires, Cylinder Wires,**  
**Brass, Copper and Iron Wire Cloth, Dandy Rolls**

## PORRITT BROR. & AUSTIN

Stubbins Vale Mills—RAMSBOTTOM—near Manchester, England

Manufacturers of every description of

**FELTS AND JACKETS FOR**  
**PULP AND PAPER MILLS**

Agents for Canada: C. H. JOHNSON & SONS, Ltd., ST. HENRY, MONTREAL

WE MANUFACTURE WOODEN WATER PIPE for Water Works Systems. SPECIALLY MADE  
PIPE for Conveying Chemicals. CONTINUOUS STAVE PIPE for Power Plants.  
Sizes from 2 inches to 12 feet diameter.

**NATIONAL PIPE AND FOUNDRY CO., LIMITED**  
Works, Alexandria, Ont. 135 Board of Trade Bldg., MONTREAL, Que.

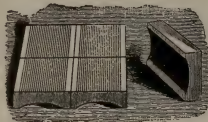

### Use Snell's Drainer Bottoms

They drain quickly and don't let the Pulp go into  
River. No Dust. No Splinters. Clean Stock.

*Send for Sample and Price*

**Samuel Snell Co., - Holyoke, Mass.**

Cable Address:—"Kaolin, Manchester." A.B.C. Codes 4th & 5th Edition

# CHINA CLAY CO.

JOHN WILLIAMSON, Manager.

4 St. Anne's Square

**MANCHESTER, ENG.**

**MINES**—Ruddle, Bojea, Colchester, South Ninestones, Tronance, St. Austen  
Cornwall.

**CONTRACTORS TO H.M. INDIAN GOVERNMENT**

Canadian Representatives—C. A. Meincke & Co., 222 Coristine Bldg., Montreal.

## A. KLIPSTEIN & Co. Ltd.

(OF CANADA)

12 ST. PETER ST. - - MONTREAL

# SULPHATE ALUMINA

**CHINA CLAY, BLEACH and CASEIN  
PAPER BLUE, both Basic and Acid  
AURAMINE - RHODAMINE**

and all other Aniline Colors

Shades Carefully Matched in our Laboratory Mention Pulp & Paper  
Magazine

New York Office - 644-654 Greenwich Street.

TELEGRAMS }  
CABLEGRAMS } MILNE, EDINBURGH

Code A B C 4th & 5th Editions.

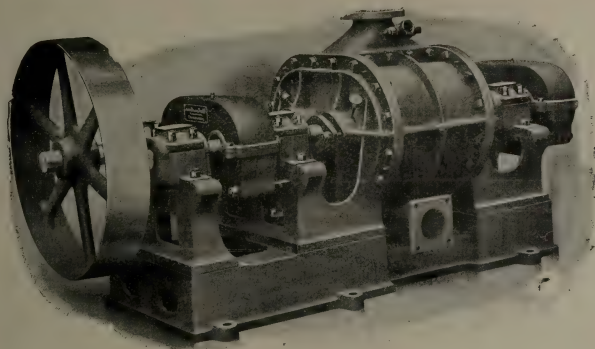

# HIGH DISPLACEMENT VACUUM PUMP

*(Made in Various Sizes)*

Suitable for

SUCTION ROLLS or VACUUM BOXES

MANUFACTURED BY

**JAMES MILNE & SON, LIMITED**

MILTON HOUSE WORKS, EDINBURGH

*DESIGNERS  
AND  
MANUFACTURERS  
OF HIGH CLASS  
PAPER MILL  
MACHINERY*

*FAST RUNNING  
PAPER MILL  
MACHINERY  
A SPECIALTY  
LEAST VIBRATION  
LEAST BREAKAGES*

*Don't Touch Your Mill Equipment Without Trying Milne.*



**LAWRENCE PUMP  
AND ENGINE CO.**

P. O. BOX 70, DEPT. 10  
LAWRENCE :: MASS.

**CENTRIFUGAL PUMPS**

We make an exclusive specialty of High Efficiency Centrifugal Pumps for Paper and Pulp Mill. In one mill 49 of our Pumps are running, the customer writes—"Your Pumps are all giving perfect satisfaction."

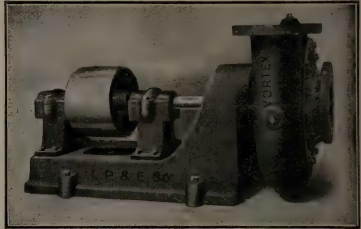

ESTABLISHED 1808.  
REGISTERED.  
TRADE MARK.

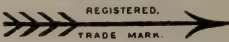

**FELTS** For Pulp and Paper Mills.

**JOSEPH PORRITT & SONS**

Agents for  
Canada  
and United  
States.

**HELMSHORE**  
Manchester, England.

All kinds  
Woollen, Lin-  
en and Cotton  
Cloths for  
Mechanical  
Purposes.

**F. BRETT & CO., 240 Water Street, NEW YORK.**

**PENMANS LIMITED**  
ST. HYACINTHE, QUEBEC

Manufacturers of  
**PULP AND PAPER MAKERS' FELTS,  
JACKETS, STRAINER CLOTHS, ETC.**

Special sizes and qualities made to order. Satisfaction guaranteed.  
**DALLYN, JARDINE & CO. TORONTO Selling Agents**

**CASTLE, GOTTHEIL & OVERTON**

*200 Fifth Avenue, New York*

AGENTS FOR

***Sulphite and Wood Pulp Mills***

Dealers in all kinds of Paperstock, Sizing, etc.

Correspondence Solicited.

# "AMPHIBIA"

(Waterproof)

## Leather Belting

Actually costs less per day  
of service, than any other  
although the purchase price  
may be a little higher.

Get a *trial order* and keep  
tab on it.

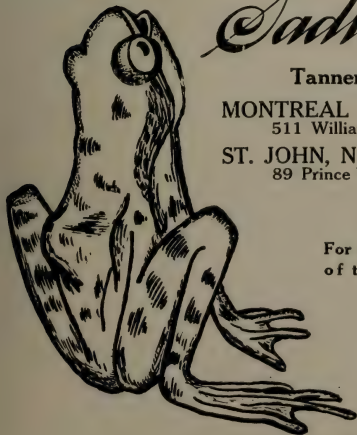

*Sadler & Haworth*

Tanners and Manufacturers

MONTREAL  
511 William St.

TORONTO  
27 Melinda St.

ST. JOHN, N.B.  
89 Prince William St.

VANCOUVER  
217 Columbia Ave.

WINNIPEG  
244 Princess Street

For over 35 years the makers  
of the best leather belts

Nearly FIFTY YEARS ago we introduced this Belt. IT HAS STOOD THE TEST OF TIME

2" to 24" in stock

Every Belt is  
Stamped with  
Trade-Mark.



Write or phone us

Beware  
of Imitations

SOLE MAKERS

F. REDDAWAY & CO.,

MONTREAL, CANADA.

**E. PULLAN,** 490 Adelaide St. W.,  
TORONTO

Largest Paper Stock Dealer in Canada

**RAGS AND PAPER STOCK GRADED TO SUIT MILL REQUIREMENTS**

**Correspondence Solicited.**

EDWARD A. JONES, President and Treasurer

WALLACE E. BARDWELL, Secretary

**E. D. JONES & SONS CO., Pittsfield, Mass.**

*Manufacturers of*

**PAPER MAKING MACHINERY  
AND MECHANICAL ENGINEERS**

Beating Engines. Washing Engines. Mixing Engines. Bleaching Engines.  
Cooking Engines. Vertical and Horizontal Stuff Chests.

Jordan Engines of three sizes, either belt or direct connected motor driven;  
fillings of Wagg Steel or stone type, three-part or plain.

Dusting Machinery of all kinds.

*People who are wise Advocate Forestry*

# The American Forestry Magazine

IS DEVOTED TO SECURING

Better Fire Protection

Proper Legislation

Fair Forest Taxation

Conservative Management

Lower Freight Rates

and Reforestation

It should be on the desk of every progressive American citizen. It is the public service publication of the American Forestry Association

AMERICAN FORESTRY MAGAZINE, ONE YEAR - \$2.00

Membership in American Forestry Association, One Year - \$1.00

Address AMERICAN FORESTRY ASSOCIATION  
Washington, D.C.

# "C.B.C." REFINER

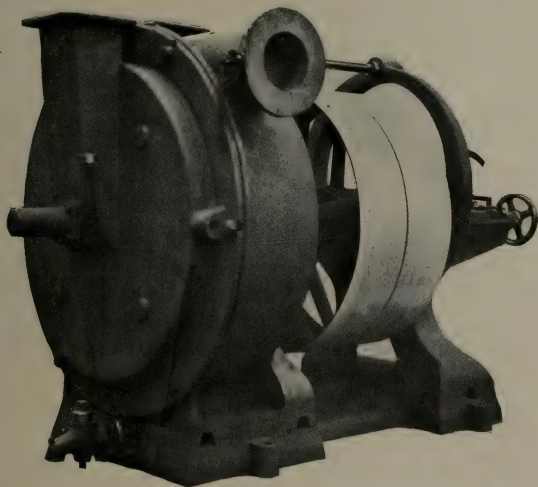

*Great strength and durability.*

*Large working capacity.*

**IT SAVES YOU ALL YOUR SCREENINGS**  
i.e., 5 to 10 per cent. of your wood consumption

**IT INCREASES YOUR PRODUCTION**  
5 to 10 per cent. without additional power

## **The Canadian Böving Co., Limited**

**164 BAY ST. - - TORONTO**

**VANCOUVER OFFICE - - 448 SEYMOUR ST.**

## ROLLAND'S PAPERS

For Business Stationery, for Loose Leaf Sheets and all kinds of printed or lithographed forms, include many textures at a wide price range. There is a paper for every need and fancy. Ask your printer to show you our sample books, or write to us for them.

Made in White, Azure and Buff. Envelopes to match all lines.

### THE ROLLAND PAPER COMPANY LIMITED

GENERAL OFFICES - MONTREAL, P.Q.  
MILLS AT ST. JEROME AND MONT ROLLAND, P.Q.

## GENUINE "KRAFT" PAPERS

*Made in Canada*

### THE NEW BRUNSWICK PULP & PAPER CO.

Springfield Mills, Millerton, N.B. Limited

*Ontario Representative - E. H. WILKINSON*

*Telephone Building, 82 Adelaide Street West - TORONTO*

## PANZL'S PATENTED LINING COMPOSITION

IS THE SAFEST AND BEST MATERIAL FOR  
LINING OF SULPHITE PULP DIGESTERS  
AND ACID RECLAIMING TANKS

### PANZL LININGS ARE SAFEST AND MOST DURABLE

They are really acid-proof and practically indestructible.

All Digesters lined with Panzl's patented composition, now as tight and in as good condition after years of continuous use as they ever were, no leaks no repairs.

Panzl Linings can be made considerably thinner than the other linings, thus increasing the capacity of the digesters.

The composition and the system of constructing of Panzl Linings are patented in all countries where wood pulp is being manufactured by the sulphite process. **The PANZL U.S. Patents have been adjudicated to be valid in law** and wholly independent of all prior patents relating to linings of digesters.

For information and estimates, address:-

### PANZL DIGESTER LINING COMPANY

505 Washington Ave.

- Muskegon, Mich.



## The Riordon Paper Company, Limited

### Fibre, Paper, Lumber.

MONTREAL - CANADA

News Paper, Hanging Paper, Wrapping Paper, Building Paper,  
Celebrated "Impervious" Spruce Sheathing and Sulphite Fibre for all  
kinds of Paper.

## Barber Paper and Coating Mills Ltd.

### GEORGETOWN, ONT.



Manufacturers of  
SURFACE COATED BOOK and LITHOGRAPHIC  
PAPERS, COATED CARDBOARD and COATED  
BOXBOARDS of every description.

## "Chalk White" Coated Book Paper.

The best and whitest coated paper sold.

**ALL REGULAR SIZES AND WEIGHTS IN STOCK.**

Our Art Litho Cover Paper is stocked in four tints,  
2 sizes. 20 x 25 and 21½ x 28½. Samples gladly sent.

MONTREAL  
TORONTO

**CANADA PAPER CO.**  
LIMITED

WINDSOR  
MILLS, P.O.

# DIRECTORY

of

## Civil and Chemical Engineers

### T. PRINGLE & SON, Limited

Engineers and Architects

Plans and Specifications for Pulp and Paper Mills, Power Plants and other Industrial Works.  
**Coristine Bldg., Montreal.**      **Continental Life Bldg., Toronto.**  
 Bell Tel.: M. 3890.      Tel.: M. 5917.

### R. S. LEA, and H. S. FERGUSON, ENGINEERS

Pulp, Paper and Chemical Fibre Mills.  
 Water Power Development and Transmission. Steam Power Plants.  
 Telephone Long Distance U.P. 75L.  
 820 New Birks Bldg., MONTREAL

### Arthur D. Little Inc.

— LABORATORY OF —  
 ENGINEERING CHEMISTRY  
 93 BROAD ST., BOSTON, - MASS.  
 Our staff includes experts in Papermaking Chemistry  
 —Sulphite Mill Practice—Fuel Engineering.

### GEORGE F. HARDY, M. AM. SOC., M.E., M. CAN. SOC. C.E.

Consulting Engineer.

Paper, Pulp and Fibre Mills, Examination of Mill Properties, Water Power Developments.  
 Mutual Reserve Building, - 309 Broadway,  
 NEW YORK.

CHARLES E. EATON,      JAMES P. BROWNELL,  
 M. Am. Soc., M. E.,      C. E.

### EATON & BROWNELL, Consulting Engineers and Architects.

Paper, Pulp and Fibre Mills, Water, Steam and Electric Power Development, Examination of Properties, Consultation Reports.  
 SMITH BLDG.,      WATERTOWN, N. Y.

### A. V. TRACY-GOULD

Pulp and Paper Mills.      Power Plants.  
 Waterworks and Sewerage,  
 Examinations.      Reports and Surveys.  
 512 New Birks' Bldg., Montreal, P.Q.  
 Telephone: Uptown 6974.

### T. LINSEY CROSSLEY

*Engineering Chemist*

PULP AND PAPER  
 TECHNOLOGY

318 Lagauchetiere St., W., Montreal

### R. O. & W. G. SWEEZEY

— Civil and —  
 Forest Engineers

Limit cruising, surveys, water storage,  
 power, lumbering contracts.

MEIRCP LITAN BLDG., QUEBEC

ASSOCIATED WITH

### HERBERT S. KIMBALL

M. Am. Soc. C. E.

Mill Architect and Engineer

111 Devonshire St., Boston

ENGINEERS SHOULD WRITE  
 THE PUBLISHERS FOR RATE  
 OF CARDS ON THIS PAGE.

**PULP** JOSEPH H. WALLACE & CO.  
**PAPER** INDUSTRIAL ENGINEERS.  
**POWER** TEMPLE COURT BLDG. NEW YORK.  
 SALISBURY HOUSE, LONDON, E.C  
 CABLES, TRIPLEX, N. Y., TRIPLEX IS, LONDON.

**C. B. PRIDE**

**MILL ARCHITECT & ENGINEER**  
**PAPER, FIBER, AND PULP MILLS,**  
**— WATER & STEAM POWER DEVELOPMENT**  
 25 YEARS SUCCESSFUL OPERATIONS  
 SPOKANE, WASH OFFICES APPLETON, WIS.

**J. A. De CEW** M.A. INST. CHEM. ENG. *Chemical Engineer*  
 A. M. CAN. SOC. C.E.

Paper Mill Analysis Pulp Testing Investigations  
 Sulphite Fibre, Soda Fibre Reports

CANADIAN EXPRESS BUILDING - - - MONTREAL

Power, Lighting, Heating, Ventilating and Drying.—Complete New Plants, Improvement of Old Plants;  
 Plans, Specifications, Contracts, Estimates, Tests, Appraisals, Inspections and Reports.—Pulp, Paper,  
 Box Board and Coating Mills.

Lowest  
 Possible

**H. B. PRATHER,**  
**CONSULTING ENGINEER,**

Guaranteed  
 Results.

Operating Cost. ROCKFELLER BLDG., CLEVELAND, O.

**HUGH R. BLETHEN**

**21 PARK ROW, - - - NEW YORK, N.Y.**

Traveling Cranes - Overhead Tramways - Trolleys and Chain  
 Hoists for Paper and Pulp Mills - Power Houses.

**Stebbins Engineering & Mfg. Co.**  
**WATERTOWN, N.Y.**

MANUFACTURERS OF

STEBBINS' ACID SYSTEMS, SULPHUR BURNER  
 DIGESTER LININGS, RECLAIMERS, ETC.

Engineering Department Plans, Estimates and Specifications for Paper,  
 under Pulp and Fibre Mills,  
 Mr. T. L. TOMLINES Water Power and Hydro-Electric Developments

# LEUNIG PAPER SCALES

Showing correctly at a glance, by weighing a single sheet, the weight of a ream of Paper of any size, containing either 480, 500, or 516 sheets.

Can also be made to indicate in addition to the English weight, the weight in Kilogrammes.

Illustrated Price List on Application.

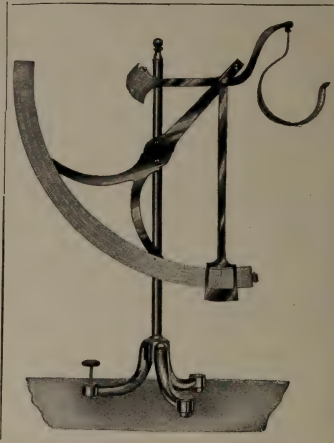

$\frac{1}{2}$  to 80 lbs.

**Price,**  
**Ten Dollars**  
F.O.B., London

$\frac{1}{2}$  to 120 lbs.

**Price,**  
**Fourteen Dollars**  
F.O.B., London

Illustrated Price List on Application.

**Alfred H. Mardon** 150 Shaftesbury Ave. **London, Eng.**

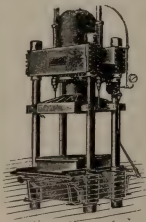

# PULP PRESSES

AND ACCESSORIES

CANADIAN BOOMER & BOSCHERT PRESS  
COMPANY, LIMITED

18 TANSLEY STREET, MONTREAL

"LACHUTE FELTS" Bell Tel. No. 23

# The Hamelin & Ayers Co., Limited

LACHUTE MILLS, P.Q.

MANUFACTURERS OF EVERY DESCRIPTION OF

# FELTS FOR PAPER AND PULP MILLS

"The Best are the Cheapest."

# Every Papermill



must have a daylight lamp.

“HELIA”

is a real daylight lamp,

strong, cheap and economical. By the aid of “Helia,” every graduation of color can be exactly determined with the same precision as in daylight.

---

---

Sole Agency in Canada and U.S.

**GUSTAF FORNSTEDT**

THREE RIVERS - - QUE

# The Union Sulphur Company

Producers of the Highest Grade Brimstone on the Market

---

Absolutely free from Arsenic, Selenium or Tellurium

---

**The Largest Sulphur Mine in the World**

**CALCASIEU PARISH, - LOUISIANA**

**Main Offices: Whitehall Bldg., 17 Battery Place**

**NEW YORK**



**WE GUARANTEE OUR SIZINGS TO BE ABSOLUTELY CLEAN  
OUR VERA PAPER SIZE**

is purest, strongest and highest free rosin size made. We can furnish you with an ideal rosin size and patented apparatus to use same.

**OUR VERA MILL SIZE**

is the best soluble paper makers' rosin size made. Ready to use in cold or warm water in the ordinary way without apparatus. Gives better satisfaction and is more economical than mill made size.

Our sizings are cleaned by our new patented process and we guarantee this size to be absolutely clean, without the least speck of impurity in the same, preventing thereby black specks in the paper. We are shipping our size in barrels or tank-cars.

**VERA CHEMICAL COMPANY**

Main Office and Western Factory  
NORTH MILWAUKEE, WIS.

Eastern Factory  
STONEHAM, MASS.

**J. R. Walker & Co.** Importers and Packers of **GRADED RAGS, PAPER STOCK  
ROPE BAGGING, ETC.**

WAREHOUSE, 35 COMMON ST., MONTREAL.

Also Manufacturers of Roofing and Building Papers. Leatherboard and Friction Board

Mills at Sault au Recollet, P.Q.

**ATTERBURY BROTHERS, Incorporated.**

*Importers and Exporters.*

**Wood Pulp, FOREIGN AND DOMESTIC Rags AND Paper Stock**

Potter Building, 145 Nassau Street, New York City.

Cable address "AFFECTIVE," New York.

**CHURCHILL & SIM**

29 CLEMENTS LANE, LONDON, E.C.

And at Manchester

**WOOD PULP AGENTS**

Telegraphic Address:—  
"CHURCHILL, LONDON."

A.B.C. CODE  
5th Edition

**HERE'S THE  
LATEST IN  
PAPER MACHINE  
TACHOMETERS**

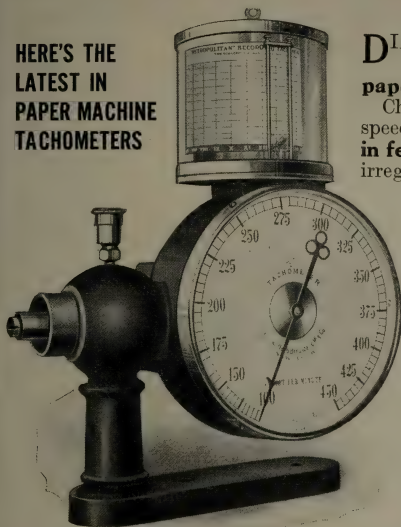

**DIAL** shows clearly the rate of speed, **directly in feet of paper travel** of the machine.

Chart gives daily record of the speeds maintained by the machine **in feet of paper travel**, shows all irregularities and shut downs.

Furthermore the record shows each break and every minute of lost time. The value of

**THE "COLUMBIA"  
PAPER MACHINE  
TACHOMETER**

is being recognized more every day, If it is of value to many of the largest mills in the country, surely it will be of value to you.

Why not try a "Columbia" Paper Machine Tachometer for thirty days at our expense?

Write for particulars and Pamphlet 423.

The  
**Schaeffer & Budenburg Mfg. Co.**  
Chicago. Brooklyn, N.Y. Pittsburgh.

**GEWERKSCHAFT SACHTLEBEN**

Homberg-Niederrhein, GERMANY

*Largest Makers  
of all Qualities*

**BLANC FIXE**

*Three  
Varieties*

Bright, Matt or Dull  
Photographic

**THE STANCLIFFE ESTATES CO. LTD.**  
DARLEY DALE - - - ENGLAND

J. H. DAWSON, Man. Dir.

**BEST ENGLISH PULP STONES** from our celebrated Darley Dale Quarries  
as supplied to the Canadian Market  
Prices and particulars on application

Liebers Code Used

Telegraphic Address, "Stancliffe," Twodales, England

---

---

# Waterous Cylinder Moulds

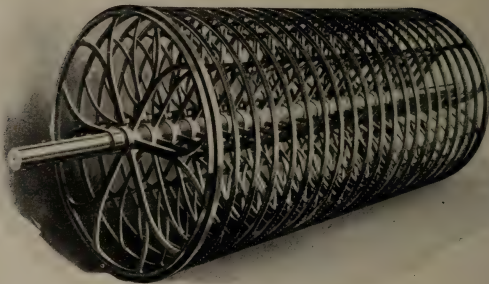

**Moulds that will remain tight and true  
until worn out—**

Waterous brass cylinder moulds are made in practically all diameters up to 48 in., and in any length.

Have a through-going shaft of steel of extra large diameter; brass spiders of special design, light and strong, and absolutely rigid.

Moulds are covered by a special process; supporting wire is wound and so inset in supporting rods that it cannot slip. Both wire cloths are sewn on by hand—not soldered.

We have a separate department with special machinery and appliances for turning out these moulds as they should be. Special Moulds for special purposes to order.

—WRITE US FOR PRICES AND DELIVERY—

**The Waterous Engine Works Co.,**

BRANTFORD

CANADA

LIMITED

---

---

**Geo. Christie Ltd.** - - **Glasgow  
Scotland**

# FOURDRINIER MACHINE WIRES

Unequaled for Strength, Smoothness and Long Life

## CYLINDER COVERS

Canadian Agent :

**J. A. Taylor, 22 St. Francois Xavier St., Montreal**

# CANADIAN TALC FILLER

**GEO. H. GILLESPIE COMPANY**

**MADOC - - - ONTARIO**

*The only Manufacturers of Paper Filler in Canada.*

Our Filler is used in Canada, United States, England, Germany, Austria, Holland, Russia and Scandinavia.

# AMBURSEN HYDRAULIC CONSTRUCTION CO.,

OF CANADA, LIMITED

**822 New Birks Building - MONTREAL**

*Associated with the Ambursen Hydraulic Construction Co., of Boston, Mass.*



## Concrete Steel Dam

OF THE

**MISSISQUOI PULP CO.,**

**Sheldon, Springs, Vt:**

Mid-channel, height 49 feet.  
Total length 270 feet (only 180 feet shows in the picture, the remainder being concealed at the left.)

Dam specially designed to withstand heavy ice gorges.

Factors of safety, are calculated for a 12-foot flood.

**IF YOU HAVE A DAM TO BUILD, WRITE US NOW.**

Every Grade of Waste for  
Paper Making.

# R. HOUGH

LONDON, England.

Agent for Canada and U.S.,

**THE J. CHRISTIE CO.**

5 King St. West, TORONTO, Canada.

STEAM PUMPS  
CONDENSERS  
VACUUM PUMPS  
TRIPLEX POWER PUMPS  
CENTRIFUGAL PUMPS

The Smart-Turner  
Machine Co., Limited

HAMILTON . . . . . CANADA

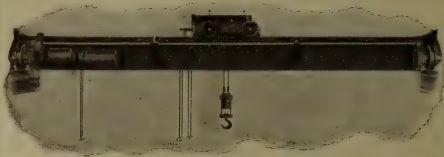
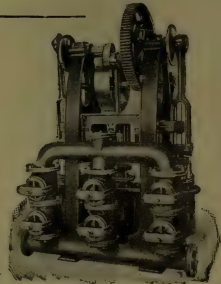

**NORTHERN  
CRANES**

and Hoists  
Overhead  
Track and  
Trolley  
Systems

**Northern Crane Works Ltd.**  
WALKERVILLE - ONTARIO

# WINN & HOLLAND, Limited

MONTREAL

PULP AND PAPER CHEMICALS.

Sole Agents for:

**BRUNNER, MOND & CO'S.**

SODA ASH,

BLEACHING POWDER,

SAL SODA,

CAUSTIC SODA, &c.



# PULP AND PAPER MAGAZINE OF CANADA

VOL. 10 TORONTO, DECEMBER, 1912 No. 12

## PRINCIPAL CONTENTS

New Pulp and Paper Enterprises  
Concentration of Waste Sulphite  
Liquor  
American Forestry Association  
Basalt Lava Beater Rolls  
Manufacture of Parchment Paper  
Paper Specialties  
Tapered Fine Grinders for  
Groundwood  
Commercial Cellulose Chemistry  
Electric Drive for Paper Machines  
Determination of the Intensity of a  
Color  
Pin Holes in Thin Paper

# THE JONASSEN PULP REFINER

For the Reclaiming of Ground  
Wood and Sulphite Screenings

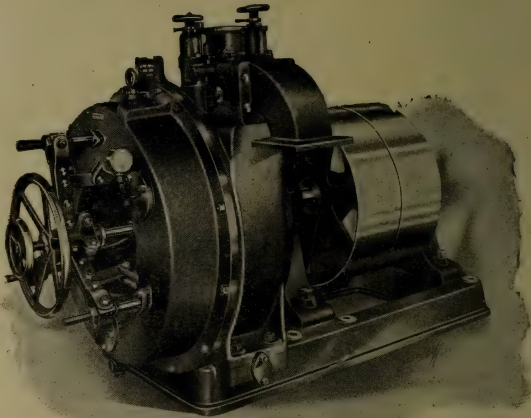

With this Refiner you save all your Ground Wood and Sulphite Tailings or Screenings, which now go to waste.

Capacity of Machine: From 8 to 10 tons of Screenings a day.

Power required to operate same: 20 horse power.

Write us for prices and further information.

Rice Barton and Fales  
Machine and Iron Co.

WORCESTER, MASSACHUSETTS, U.S.A.

## It's Easy to Handle Your Pulp Wood Economically

The Most Important Part Being the Selection of the Equipment



Jeffrey Chain Conveyor in mill of E. B. Eddy Co., handling logs from the water and delivering to saw-table

The installation of a Jeffrey Conveying System at this plant has resulted in a saving of over 75% over the former methods of handling, storing and piling the wood from the saw mill.

*We will gladly furnish upon request, complete information regarding this installation. Write for Catalog No. 57-D also.*

## JEFFREY MANUFACTURING CO.

Canadian Works and Main Office, Montreal. Winnipeg Representatives, N. J. Dinneen & Co.

E. J. WELCH, *President and Managing Director*  
HENRY W. S. DOWNS, *Superintendent*

EMMONS CROCKER, *Vice-President*  
A. S. MORSE, *Secretary and Treasurer*

# SCREEN PLATES



The "Union" Bronze (best phosphorized cast metal) Plates for Sulphite Mills. The Standard Rolled Brass Plates. The "Union" Cast Metal Suction Plates.

We carry a large stock of blanks of the various sizes in both metals and can fill all orders promptly.

Old plates reclosed and recut by our process are practically as good as new and give better results than by any other process

## Union Screen Plate Co. of Canada, Limited

FACTORY : LENNOXVILLE, QUEBEC.

OFFICES : Lennoxville, Quebec, and Fitchburg, Massachusetts, U. S. A.

— THE BEST —  
**JORDON ENGINE**  
IS BUILT BY THE



**APPLETON MACHINE CO.**  
APPLETON, WIS.  
SEND FOR PARTICULARS

**DODGE**

**Transmission** —\*

—\* **Machinery**

— **High Grade Only** —

**Shafting, Hangers, Pulleys,  
Friction Clutch Pulleys.**

**DODGE MANUFACTURING CO.**

640 ST. PAUL ST. HAYMARKET SQUARE **MONTREAL** LIMITED

Telegrams :  
"CALENDER, BURY"

Telephone :  
NUMBER 340

# Bentley & Jackson,

Limited

PAPER MAKERS'

.. ENGINEERS ..

BURY, - - ENGLAND

## *SPECIALITIES.*

MODERN HIGH SPEED NEWS PAPER  
MAKING MACHINES

SINGLE CYLINDER PAPER MAKING  
MACHINES

*The NEW "MARSHALL" PATENT REFINING ENGINE*  
with separate adjustment to cones and discs, and our patent  
Ball Thrust Bearing

*HELIN'S PATENTED BEATING MATERIAL*  
for Beater Rolls and Bedplates in all types of Hollanders.

"Marshall" Refiners and "Jordan" Engines filled  
with this material are giving excellent results.



# Bertrams Limited

SCIENNES

Edinburgh - - Scotland

---

---

*Fast Running Paper Making  
Machines*

*Single Cylinder Machines*

*Bleaching, Washing and Beating  
Engines*

*Improved Refining Engine*

*Motor Driven Centrifugal Pumps*

*Highest Quality Hard Metal  
Screen Plates*

---

---

Full particulars from

**CHAMBERS & SIMPSON**

152 Bay St. - Toronto, Ont.

# New Centrifugal Screen

WITH HORIZONTAL SHAFT

PATENTED IN ALL PRINCIPAL COUNTRIES

**Smallest Power  
Highest Output**

**Direct Belt Drive  
Noiseless Working**

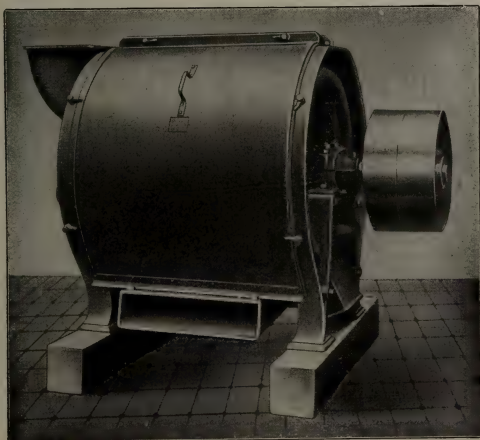

Equally well adapted for GROUND WOOD and SULPHITE

*I have now sold over 1000 of these Screens*

FURTHER DETAILS, PROSPECTUS AND PRICES ON APPLICATION

**Complete Machinery for Wood Pulp, Paper and  
Sulphite Mills**

---

---

## J. M. VOITH

ENGINEERING WORKS AND FOUNDRIES

HEIDENHEIM ON BRENZ, WURTEMBERG, GERMANY

Branch Office for Canada and U.S.A., 1008 Fifth Ave. Bldg., New York

Representative: H. F. STORRER, C.E.

J. MARX &amp; CO.

--

LONDON, E. C., ENGLAND

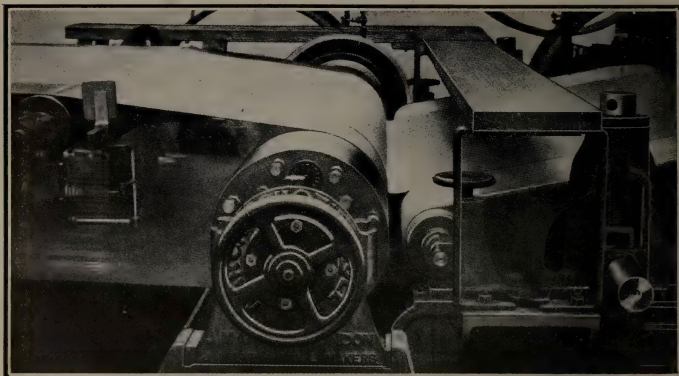

MARGALT SUCTION ROLL AT WORK

SPECIALTIES BASALT LAVA STONE BEATER ROLLS, DOUBLE BEATERS, STONE WET PRESS ROLLS, BASALT LAVA PULP REFINERS FOR SCREENINGS

Canadian  
Representative

**Judson A. DeCew**

Canadian Express  
Building

**Montreal**

*The*  
**Harmon Incline Screening System**

Will give greatest capacity.

Will give cleaner stock.

Will save power.

Will save labor.

Does not require use of Rakers.

Write us for full descriptive Catalogue and testimonials from the best mills in the country.

**HARMON MACHINE COMPANY**

**WATERTOWN, N. Y., U. S. A.**

OTTO WANDEL  
President

HERBERT H. MILLER  
Treasurer

# Wandel Screen Manufacturing Co.

WALPOLE, MASS., U.S.A.

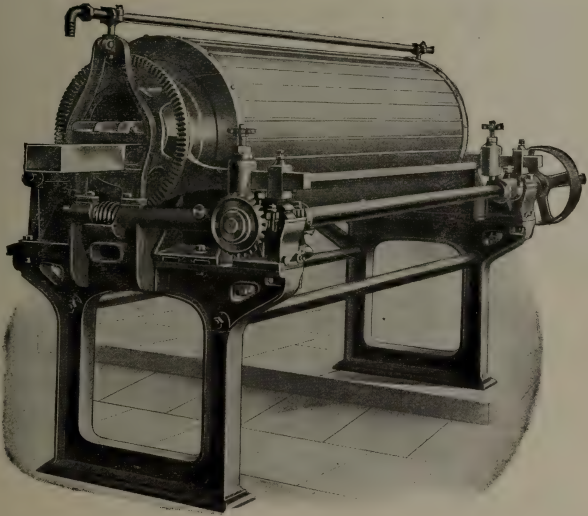

MANUFACTURERS OF THE

Quick Delivery.  
Write for Catalogue  
and list of users.  
We have no author-  
ized Agents in  
Canada.

# WANDEL ROTARY SCREEN

Over 200 Wandel  
Screens have  
been built and sold  
by us in the States  
within two years.

## SUPERIOR CONSTRUCTION

---

**THE SANDY HILL IRON AND BRASS WORKS, HUDSON FALLS, N.Y.**

---

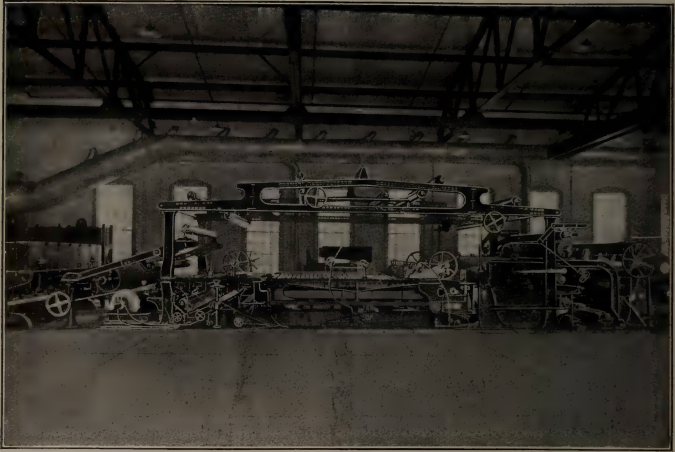

130" HARPER FOURDRINIER PAPER MACHINE

---

## A GOOD JORDAN ENGINE

BUILT IN 3 SIZES.

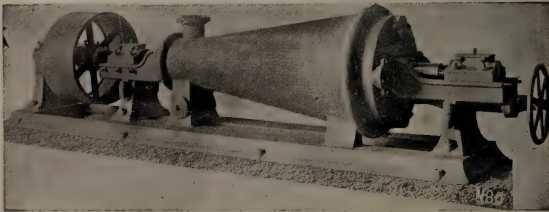

## THE BLACK-CLAWSON CO.

HAMILTON, OHIO, U.S.A

Builders of **PAPER MAKING MACHINES** and machinery for Paper and Pulp Mills. Our machines are completely erected in shop on cast iron levelling plates and carefully inspected before shipment.

*Write for Catalogue.*



# The "WESTBYE" SCREEN

*Its Novel Features are of Importance to You*

Built for Belt or Motor Drive

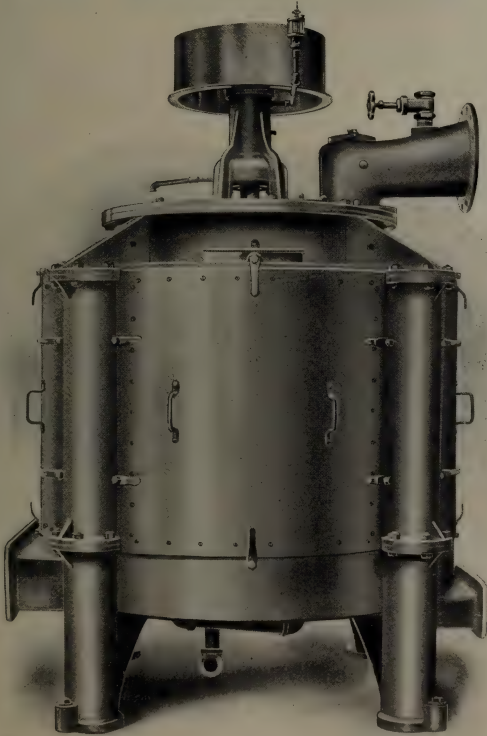

Investigate and learn something NEW in the screen line

*For Details and Prices  
apply to*

**P. P. WESTBYE**  
**PETERBOROUGH,**  
**CANADA**



## GARLAND PULP LOG Storage and Conveying Systems

Inventors of the CABLE CONVEYER

*We have equipped 50 of the best American PULP and PAPER MILLS with CONVEYERS, LOG CUT OFF SAWS, SLASHERS, SPLITTERS, BAND MILLS and SPECIAL MACHINES*

*Send us your plans or ask for Representative to call on you*

---

### THE M. GARLAND COMPANY

Manufacturers of CONVEYING, SAW MILL  
and WOOD DESTRUCTIVE MACHINERY

BAY CITY - - - MICHIGAN, U.S.A.

# BELOIT IRON WORKS

## PATENT ADJUSTABLE STEAM JOINT AND DUPLEX SAFETY VALVE

*The latest improved and most up-to-date steam joint in use*  
*No Packing Required* *All Metal Joints*

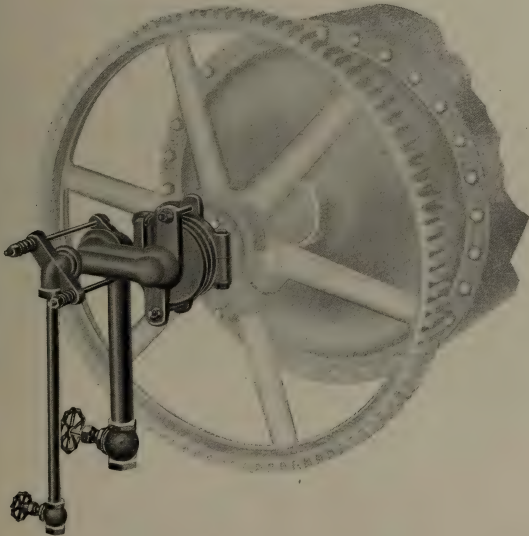

Self Adjustable. Takes care of expansion and contraction, also irregularity of piping. A positive safety valve pressure in dryers cannot exceed a determined amount

Over 1500 sold in the past three years

WRITE US FOR FURTHER INFORMATION AND PRICES

# BELOIT IRON WORKS

BELOIT

WIS., U.S.A.

LEADING BUILDERS OF PAPER MILL MACHINERY SINCE 1856

# DILLON MACHINE CO

## BUILDERS OF PAPER MILL MACHINERY

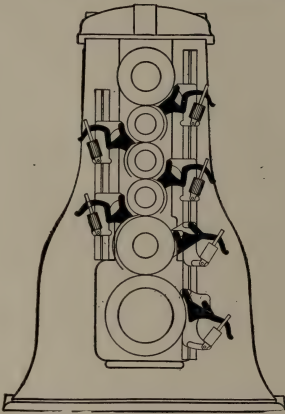

Beating Engines  
 Washing Engines  
 Jordan's Three Sizes—  
 Single, Double & Triple  
 Stuff Pumps, with  
 Dillon Patent Valve  
 Seating

Brannan Patent Paper  
 Folders

Horizontal and Vertical  
 Stuff Chests

Single and Double Paper  
 Cutters

Backstands

Plates, Knives and Bars

DILLON  
 PATENT  
 DOCTORS  
 AND FEEDS  
 MADE IN  
 CANADA  
 BY THE  
 SHERBROOKE  
 IRON WORKS,  
 SHERBROOKE, P.Q.

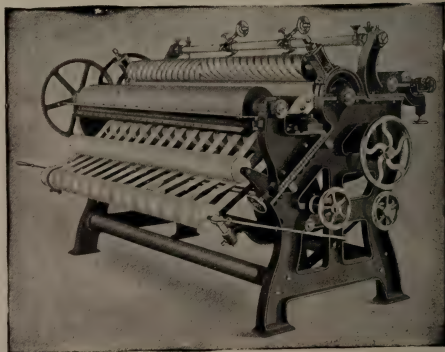

LAWRENCE, MASS., U.S.A.

---

---

# THE MOORE & WHITE CO.

ENGINEERS, FOUNDERS, MACHINISTS

PAPER MACHINE BUILDERS

Inquiries solicited and given prompt and careful attention.

Specifications and estimates for paper and pulp machinery on either new or repair work cheerfully given

Quality guaranteed strictly high-grade



Office and Works, North Philadelphia Station, P. R. R.  
Philadelphia, U. S. A.

PAPER MACHINES FOR ALL GRADES OF PAPER

ALL GRADES OF BOX BOARDS

ROOFING, FELT AND BUILDING PAPERS

SATURATING AND ASPHALT COATING MACHINERY

“M & W” FRICTION CLUTCHES

“M & W” VARIABLE SPEED CHANGES

PRINTING MACHINES

FOR FLOOR CLOTH AND LINOLEUM

Bulletins and information on any of the above subjects sent on request.

---

---



# HOLYOKE MACHINE COMPANY

## HOLYOKE, MASS., U.S.A.

MANUFACTURERS OF

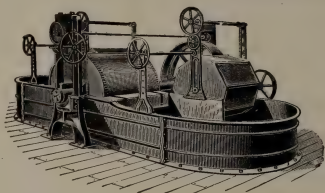

Washing and Beating Engines with  
Patent Double Hoist and Tubs of either  
wood or iron.

Hydraulic Pumps and Presses.

Rag Cutters and Rag Dusters.

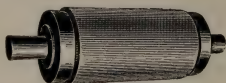

Cotton and Paper Rolls with Patent Fastenings.

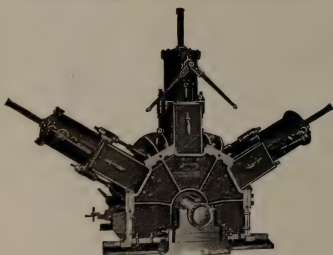

Patent Improved Wood Pulp Grinder.

Elevators, Rotary Fire Pumps and  
Friction Gearing.

Gears Accurately Spaced and Planed.

Shafting, Pulleys and Mill Work.

Machinery for Wood Pulp and  
Paper Mills.

Vertical and Horizontal Water  
Wheels with Flumes and  
all connections.

Wood Barkers, Wood Chippers  
and Wet Machines.

## Newest Designs

AND

## Highest Efficiency

Calenders. All kinds of Super  
Calenders, Friction Calenders  
and Platers.

Chilled Iron Rolls.

Special Machinery

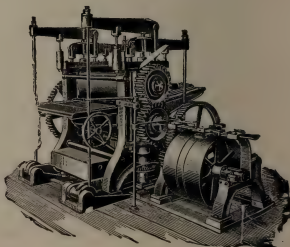

Description and Estimates Furnished; also Gear List  
and Catalogs sent on application.

# Pulp Mill Machinery

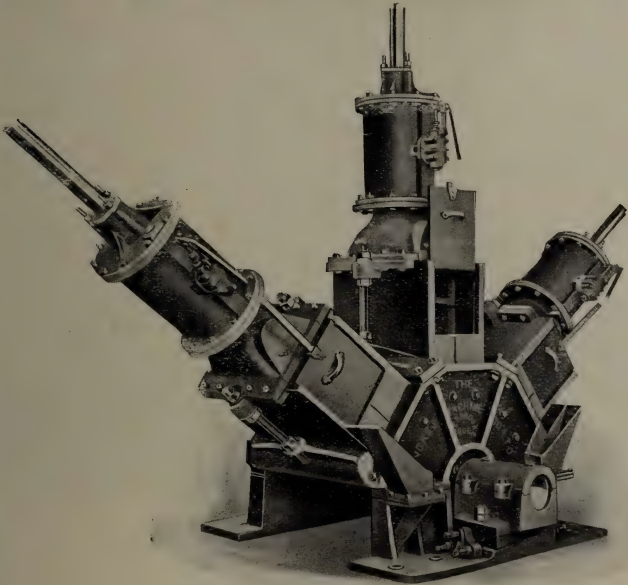

Our Grinders combine the latest and best features in Wood Pulp Grinder construction and have many recent improvements.

We also manufacture Wet Machines, Screens, Presses, Barkers, Complete Wood Room Equipment and Turbine Water Wheels.

LET US QUOTE ON YOUR REQUIREMENTS.

## The Jenckes Machine Co., Limited

General Offices: SHERBROOKE, QUE.

Factories: Sherbrooke, Que., St. Catharines, Ont,

Sales Offices: SHERBROOKE, MONTREAL, ST. CATHARINES, COBALT  
SOUTH PORCUPINE, VANCOUVER, NELSON, B.C.

# James Bertram & Son

LIMITED

LEITH WALK

EDINBURGH

- -

SCOTLAND

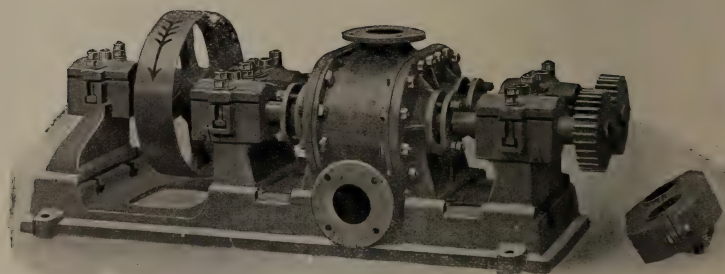

## Rotary Drum Pump

Specially Designed for Paper Making Machines

---

Specialty: Paper Making Machinery

---

*Full particulars on application*

*Telegrams: Bertram, Leith*

---

---

# Economy

Just a suggestion.

Our machinery has demonstrated that it can produce a larger output at less expense than other types.

Hence we suggest—as a matter of mutual interest—that, in asking for quotations or specifications of new machinery, you obtain exact information as to the output each machine is giving, *and* its efficiency; that is, the amount and value of its output as against the amount and cost of power, maintenance and attendance required.

The real—and only—value of every piece of machinery is in the number of dollars it earns for every dollar it costs.

Our pneumatic Save-Alls are valuable because of their enormous earning power. This is being demonstrated even in mills where it was assumed that the waste was negligible.

Our Wet Machines are valuable because they are yielding up to twice the output of less efficient makes of machines which they are supplanting, and are doing this on a cheaper basis of operation.

We suggest merely that you receive and investigate our figures.

We build promptly whatever you want, but we have also our Standard Line of WET MACHINES, PULP THICKENERS and SAVE-ALLS, which can be supplied at short notice, duplicating the machines which we have supplied to many prominent mills.

Each machine is intended to *give the customer the largest possible return for his money* in

**Strength of Construction (giving rigidity),**

**Durability (avoiding cost of repairs),**

**Economy of Operation.**

**Evenness and High Quality of Product**

**And (wherever possible)**

**Automatic Action and Regulation.**

## **Sherbrooke Machinery Company**

Limited

SHERBROOKE

QUEBEC

## HANS RENOLD PATENT LINER SILENT CHAIN

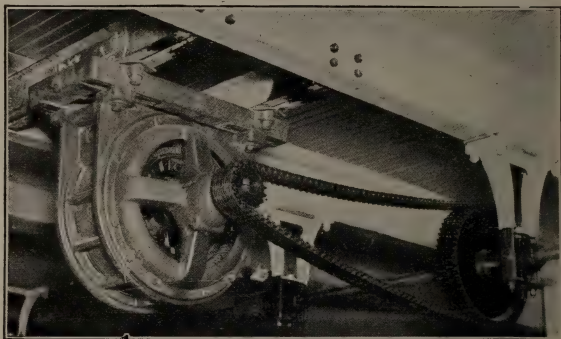

35 H. P. Chain Drive with Motor Bolted to Ceiling

WE HAVE HUNDREDS OF THESE CHAIN DRIVES NOW RUNNING IN CANADA

Above illustration shows one of the Chain Drives in the new works (COMPLETELY EQUIPPED with HANS RENOLD SILENT CHAIN) of one of the Largest Manufacturers in Canada

**JONES & GLASSCO, Engineers,** SOLE CANADIAN AGENTS **MONTREAL**  
(REGISTERED)

## Lawrence Machine Co.

LAWRENCE

MASS.

— MANUFACTURERS OF —

### Lawrence Centrifugal Pumps

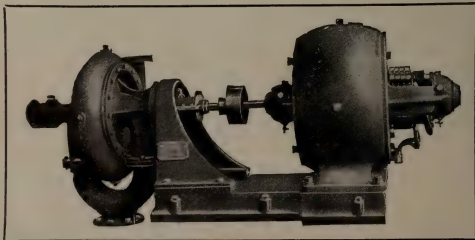

LET US FIGURE ON YOUR REQUIREMENTS



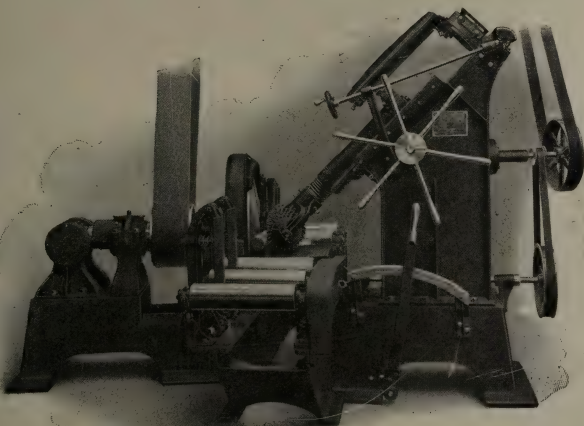

## **DIVIDENDS!**

Is your Barking Installation paying you a large Dividend on the money invested ?

If it is not, you can make it do so.

**Canadian Barker Co., Ltd.**  
Sault Ste. Marie, Ontario



Interior of the  
Machine  
Room of  
Messrs. Ed-  
ward Lloyd,  
Ltd.

Sittingbourne,  
England,  
containing the  
last two  
machines  
supplied to  
this Company  
by Chas.  
Walmsley &  
Co., Ltd.

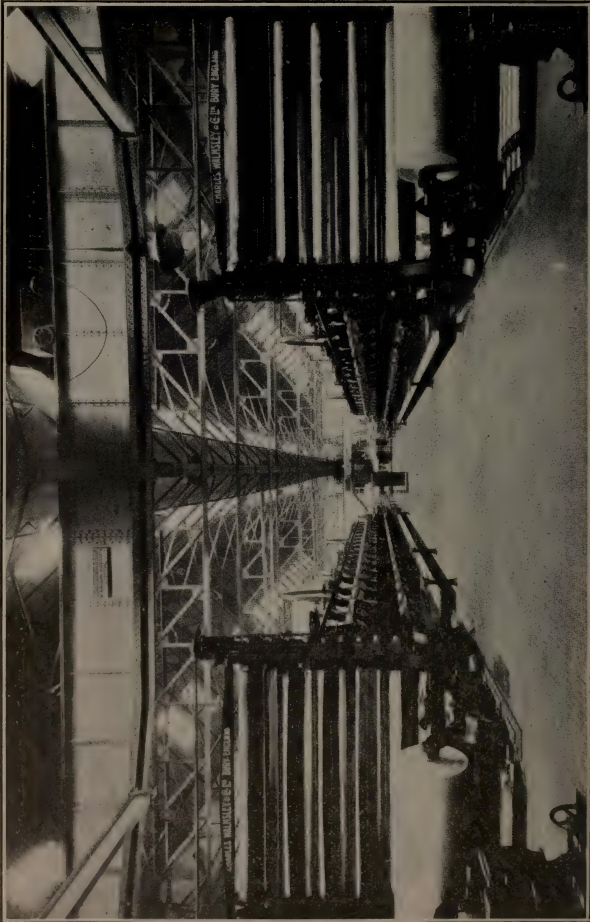

These "Walmsley" Fast News Machines are 175 inches wide, and are making paper at over 600 feet per minute, with an output of 500 tons news print weekly. The machines are equipped with the Lloyd and Hutchison Patent Drive. This patent device is controlled by Walmsley & Co., Ltd., and dispenses entirely with Friction Clutches and Gear Wheels.

# Charles Walmsley & Co. Ltd.

PAPER MAKERS' ENGINEERS

BURY - England

Head Offices,  
ATLAS WORKS  
Branch,  
WOOD STREET

*Codes, WESTERN UNION, A.B.C. 5TH EDITION,  
MCNEILL'S 1908*

*Telegrams, "PUMPS, BURY."*

*Telephone, BURY 499*

## SPECIALTIES—

Complete Paper Mill Plants  
Variable Speed Enclosed Steam Engines  
Cone Beaters for News Stock  
Slitting and Re-Reeling Machines  
Beating and Refining Engines  
Super Calenders  
Buffing Machines, etc., etc.

## FOREIGN REPRESENTATIVES

Norway, Sweden and Finland :  
N. A. EIE - Christiania  
Austria, Hungary :  
F. SCHOFFEL, Engineer, Vienne  
CANADA :  
C. H. JOHNSON & SONS  
LIMITED  
ST. HENRY, MONTREAL

# Wilson-Paterson Co'y



127 BOARD OF TRADE BLDG., MONTREAL.

Agents for the United Alkali Co. of England

## **OFFER TO THE TRADE:**

Caustic Soda 60° to 78° Soda Ash, Caustic Potash, Sal Soda, Silicate of Soda, China Clay, Rosin size and a full line of Rosins, direct shipment from the south.

**Contracts made for regular supplies.**

# PARSONS TRADING COMPANY

*Exporters of Paper to all Parts of the World*

WHITEHALL BLDG., 17 BATTERY PLACE, NEW YORK

BRANCH OFFICES AT

LONDON

SYDNEY

MELBOURNE

WELLINGTON

CAPE TOWN

BOMBAY

HAVANA

MEXICO, D.F.

BUENOS AIRES

**CORRESPONDENCE WITH MILLS SOLICITED**

# THE CARTHAGE CHIPPER

WILL INCREASE YOUR CHIPS. WILL  
DECREASE YOUR SAWDUST. By virtue  
of its Design and its Patent Feed Spout it takes a  
MINIMUM AMOUNT OF POWER.

---

Ask Anglo- Newfoundland Development Co.  
Ask Laurentide Pulp and Paper Company.  
Ask The Riordon Paper Company, Limited.

---

OR WRITE

**CARTHAGE MACHINE CO.**  
**CARTHAGE, N.Y.**

# Pulp and Paper Magazine of Canada

*A Magazine devoted to the interests of Canadian Pulp  
and Paper Manufacturers and the Paper Trade.*

SUBSCRIPTION PRICE; \$2.00 a year. Single Copies, 20 cents.

OFFICE OF PUBLICATION: 243-4-5 Confederation Life Building, Toronto, Canada  
MONTREAL OFFICE: 34.B. Board of Trade Building

---

---

## *New Pulp and Paper Enterprises*

---

Adverse opinions have been floated by a few as to the future of the Canadian pulp and paper industry, and as is usually the case, such opinions are hastily based on ephemeral conditions. Only a year ago, the air was full of reports of the marvelous prospects and the inexhaustible wealth to be obtained from the manufacture of ground wood pulp in Canada. This was towards the end of an extremely dry season, following upon several years in which droughts were a marked feature. The year just closing on the other hand has been noteworthy for an almost unprecedented precipitation in most parts of the pulpwood timbered section of Canada and the Eastern States, an important market, and already the doubt is heard lest there may be so many pulp mills in the country as to lead to over-production. Now, as a straight business proposition, both these opposite opinions may be based on insufficient evidence. The probable future demand should be gauged neither by this year's experience, nor by last year's.

In Europe, it occurs to us, there is still a certain timidity about accepting the American investor's

valuation of railroad stocks because this is so frequently based on the earnings of one or two years. Years ago an American railroad stock which had been valued at \$50 would shoot up to \$100 on the strength of one year's good crop in its territory or conversely a \$100 stock would fall to half simply because of one poor crop showing. Nowadays, even in America, a more conservative basis of valuation is adopted, and results are founded on an average of several years.

This has only an indirect connection with pulp and paper; yet it will serve as an indication of the more rational policy to be pursued in estimating the possibilities of the industry. There will prove to be ample scope for all the pulp mills in Canada, and many more in the future. But they will have to be located and managed in the right manner, and the stock promotion end will have always to take subsidiary place compared with the merits of each enterprise as a manufacturing and commercial proposition.

The same conservative attitude is in order in judging of the newsprint end of the industry. There has been



a great growth in the capacity of Canadian newsprint manufacturing establishments during the past year, and when plants now in course of construction shall have been completed, with the addition of another large aggregate tonnage, an extraordinary growth in this great Canadian industry will have been registered. Some fear had been expressed whether the market would be able to absorb all the new offerings. Fortunately it has been able to do so, almost without a tremor. But it must be admitted that a lucky combination of circumstances helped towards this, such as great prosperity all over the continent, the United States elections and so forth.

But because this is so, it does not mean that the time is ripe for a flood of hastily devised ill-judged paper enterprises to be placed before the investing public, with its attention called more to the stock and bond end of the schemes than to the legitimate profits from a rising industry. So frequently it happens that great advances in an industry are followed by a regiment of stock-jobbing propositions, from which nobody except the promoter and the broker reap any profit, that perhaps this is the right time to sound a word of caution. The Pulp and Paper Magazine certainly has no wish to discourage sound enterprise in either the pulp or paper field, but it believes that at this particular stage very great care should be exercised before launching money into new enterprises, unless the character of the promoters and the future management be such as to be implicitly relied upon.

The consideration of the question whether in view of the free importation of wood pulp from Canada, the United States is bound to grant free entry to other countries which enjoy favored nation treaties, has been again postponed, this time indefi-

nitely. It will be remembered that months ago the case came before the Board of General Appraisers in Washington, and that they decided against the importers on the ground that favored nation clauses did not come into play because Canada was not a state or nation, or on some such peculiar twist of language. The case was then brought before the U. S. Court of Customs Appeals, with the above result. There is a rumor that it will come up for argument in the Circuit Court of Appeals, Brooklyn, shortly, but of this there seems to be no confirmation. The root of the delay in settling this matter one way or another would appear to be politics. President Taft's great chef d'auvre reciprocity, has proved a veritable white elephant for his administration. It is the importers in the U. S. who are trying to have the matter decided, although more in their customers' interest than in their own, for their business is contracted for with the provision that duties if paid would be allowed to customers, on the Government refunding same.

Canadians, like the good neighbors they are, view with equanimity and approval the choice made by the people of the United States for their next Chief Executive. For President-Elect Wilson they have every good wish and something of admiration for what they have heard of the man. As to the victory of the party which he represents, there is rather a misgiving as to its possible effects on the trade and industry of the country, though the general feeling is that prosperity in the United States has already gained such an impetus as will carry it forward for some time to come, anyhow, in spite of political setbacks. As to the effects of Mr. Wilson's election on tariff relations between the two countries, Canadians have enough faith in the character of the man to believe that any proposals made by him will be fair

and above board, not sub rosa attempts to make Canada an "adjunct" through specious promises.

The reported application to the Quebec Government by prominent paper manufacturing concerns in that province for a removal of the export restrictions on pulp wood cut on Crown Lands, would appear to contradict a rumor which was going the rounds a few weeks ago to the effect that Canadian manufacturers as a body were bringing strong influence to bear on the Federal Government to prohibit the export of wood. Paper made from wood cut on Crown Lands now has to pay an extra duty of \$5.65 per ton on entering the United States on the ground that the Provincial Government places an embargo on the wood exported from such lands. Against that, the presumption is that domestic manufacturers can obtain somewhat cheaper wood in competition with manufacturers in the United States. The Government's reason for the embargo, as is well known, was to encourage the utilization of wood and water power by pulp and paper manufacturers within the limits of the Province and this idea has certainly worked out well in practice. The Quebec Government is said to be considering the proposal, but we do not see how it can consistently go back upon its past policy except in some such way as was accomplished by the Government of British Columbia in the case of a certain company which never intended to export wood, but wanted the advantage of being able to ship its paper product without payment of the extra duty. The decision will be awaited with great interest.

While the ill-fated reciprocity pact was a serious menace to Canada, even to some lines of paper manufacturing which, if any industry could, would have received some benefit

from a material standpoint, the measure was looked upon as cruelly unsatisfactory from an American standpoint, as may be judged from the following resolution passed recently by the Empire State Forest Products Association:

Resolved, That our association, composed of men of all shades of political opinion and engaged in the management and development of forest lands as well as in the various branches of manufacturing requiring forest products, does hereby denounce the so-called Canadian Reciprocity Treaty (otherwise called the McCall bill), and urges its immediate repeal. It is (1) class legislation pure and simple, and (2) it opens the American market to a product which under existing conditions can be produced more cheaply in Canada and elsewhere than in the United States, and it thereby singles out for assault an industry which needs protection from competition by the cheaper products and labor of foreign countries without resulting in any benefit to the American consumer;

And we further represent to the Congress of the United States, upon our honor as American business men, that unless such a course can be pursued the result will be disastrous to the paper and pulp manufacturing trades and will produce a serious effect upon general business conditions in this country."

Poor President Taft with the abortive measure of his lifetime kicked about by the two peoples whom it was its alleged purpose to benefit. It would be one of the tragedies of the century if it were not such a farce.

The taking up of large tracts of valuable timber lands in Quebec by unscrupulous promoters or their agents in the guise of settlers has caused no end of trouble, besides being the means of detriment to bona-fide farmers. All sorts of means

have been taken to combat the evil, but it has been difficult to eradicate so ingenious have been the means adopted to cheat the country. But that the Government has not been idle is shown by the fact that it has collected during the last three or four years no less than \$225,000 in

penalties for timber illegally cut under the pretence that it was by actual settlers, and has canceled grants aggregating thousands of acres. This has not cleared the province of the evil, by any means, but it has cleared the air and perhaps prevented the scourge from spreading.

### *Concentration of Waste Sulphite Liquor.*

Carleton Ellis, Montclair, N.J., assignor to Ellis-Foster Company, has been granted a United States patent on a process for concentration of waste sulphite liquor.

Ordinary waste sulphite liquor is unsatisfactory for the treatment of roads, but in concentrated form, it is claimed, it has considerable binding qualities, and were it not for its marked solubility in water it would be extensively used for this purpose. Of course, it is possible to waterproof the material more or less by the use of oils, especially oils containing asphaltic bases, but this involves some expense and trouble in preparation and in many cases a considerable portion of the soil has to be present in order to secure satisfactory resistance to moisture and rain.

The invention has for its object the production of a binding material from the concentrated liquor which is relatively unaffected by moisture so that it may be used without oil or with a minimum amount of the latter. Ordinary concentrated sulphite liquor is more or less hygroscopic, and this tendency to absorbing moisture is due in part to the presence of certain saccharine matters which are present in the liquor, oftentimes in an amount of several per cent. or so. The present invention concerns the treatment of the liquor so as to remove these undesirable sugary matters and render the liquor better suited for use as a road binding material. After the liquors are received from the paper mill there is more or less acid due to the presence of sulphurous acid and it is necessary to neutralize the acidity, which may be done either with the addition of lime or other alkali or the

waste alkali liquors from the manufacture of soda pulp may be used for such neutralization. At this point, there is oftentimes a separation of the sludge which contains a good deal of lime, and the sludge may be removed and treated with sulphurous acid and again used in the manufacture of sulphite powder.

In order to remove to a large extent the sugary matters from the liquor, I subject it to fermentation. This is conveniently done in the neutralized liquor, which may be concentrated more or less if desired prior to the fermentation treatment. In order to conduct the fermentation properly, the neutralized liquors should be cooled and aereated. Yeast or malt extract or other fermenting material is then added, and the liquor allowed to stand under suitable fermenting conditions for several days until the sugary matter has been very largely destroyed. The liquor may then be filtered in case further separation of insoluble matter has occurred and then placed in an evaporating pan such as a multiple effect evaporator. The first runnings from the evaporator contain water and alcohol and the latter may be recovered by distillation or rectification in any suitable or standard manner. The liquor in the evaporator is concentrated, preferably, until its specific gravity is about 30 degrees Be., when it may be again put through a filter or filter press and is ready for use as a road binding material.

The finished product may be used directly on roads either in its concentrated form or diluted with one or two volumes of water, more or less, and if desired, a small quantity of petroleum residuum, asphalt

oil and the like may be incorporated therewith.

In the cut 1 is a neutralizing tank, having the inlet 2 for steam and steam exhaust pipe 3. A sludge outlet is provided at 4.

5 is a filter press and 6 a rotary pump intended to elevate the liquors to the fermentation tanks 10.

7 is an air blower adapted to force air into the liquor and thus aerate it.

8 is a cooling device.

ing agent is added to render the liquor substantially neutral. It may be even over-neutralized without disadvantage. The liquor may be heated by means of steam equipment indicated by 2 and 3, which furnish steam to a jacket on the bottom of the tank. After settling, the liquor is drawn through the filter press 5, is aerated by the pump 6 and cooled by the cooling means 7 and 8. It is then run into the tanks 10 and yeast or other fermenting material added and the liquor is al-

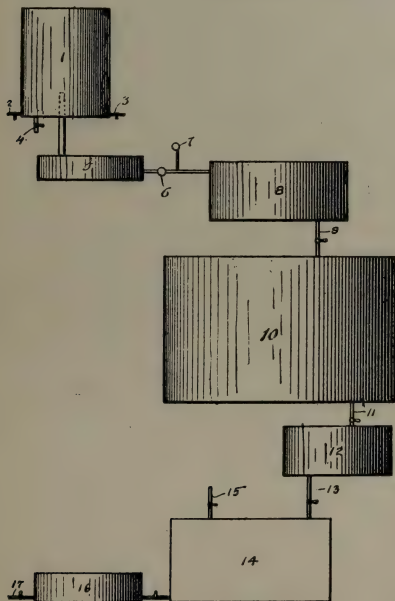

Pipe 9 acts as a distributor conveying the liquids to the various fermenting tanks 10. From these tanks the liquid is drawn by the pipe 11 through a rapid filter 12 and by means of pipe 13 to the evaporator 14. It discharges from the evaporator into the filter press 16 and the finished liquor is withdrawn by the pipe 17. An outlet on the evaporator is provided at 15 for the removal of water, alcohol, etc.

The operation of the apparatus is as follows: The raw sulphite liquor is placed in the tank 1 and lime or other neutraliz-

lowed to stand until the fermentable sugars have become very largely destroyed. The liquor is then run through the rapid filter 12 into the evaporator 14, where it is concentrated preferably to a gravity of about 30 degrees Be. Of course, the first runnings containing alcohol and other products of fermentation, etc., may be conveyed to a still of any ordinary or standard type and redistilled. The concentrated liquor which at this point of not entirely free from precipitated matter may be run through the filter press 16 in order to filter



the liquor and produce a clear product. The concentrated liquor may also be used in the cloudy condition, or even with a considerable percentage of precipitated matter providing such precipitate is not so dense as to settle and form a hard cake in the container. The presence of a mod-

erate amount of flocculent precipitated matter is for some purposes desirable and in the manufacture of the composition in this condition filtering may be omitted except such filtration as may be required to remove the denser or heavier portions of separated bodies.

---

## American Forestry Association.

The following address was delivered by Mr. P. S. Ridsdale, executive secretary of the American Forestry Association and editor of *American Forestry*, at the annual meeting of the Empire State Forest Products Association at Watertown, N.Y., November 14, 1912.

It is a natural part of the work of the association to keep in close touch with foresters, timberland owners and lumbermen, in fact with all who have interest in the growth, cutting and marketing of wood and its products, and I find that there is no more effective way of doing this than to be present at meetings of this kind, becoming acquainted with men representing different phases of the timber industry in different parts of the country and personally acquainting them with the objects of the association, and the kind of work which it is now doing, and plans to do in the future.

Unfortunately, until quite recently, the impression prevailed that the association was a sort of sentimental organization, preaching forest conservation as a theory, and unable to do anything of a really practical nature in securing real conservation of the forests. Laboring under that handicap the association did not make the progress it should have done, but now I am happy to say, the results of the last two or three years work have convinced many lumbermen and timberland owners who at first were opposed to the association because they did not thoroughly understand its ambition, that it is doing a work which will be not only beneficial to the entire country, but will be of direct practical value to them. I will admit that there are many lumbermen who are still uncon-

vinced that there is a real need for such an association as ours, but the number of these are being rapidly reduced. During the past year sixty per cent. of the new members who joined the association are lumbermen and timberland owners, while we have several lumber and timberland associations affiliated with us as sustaining members, and on our board of directors are some of the leading paper and pulp men, lumbermen, timberland owners and foresters of the country.

As an evidence of the practical work of the association I want to briefly state some of its recent accomplishments. The successful fight for the passage of the important Weeks bill by which the government was enabled to acquire much land in the White Mountains and the Southern Appalachians as forest reserves; the fight against the effort to cut down the appropriation for the Forest Service, and against the attempt to pass an amendment to the Agricultural Appropriation Bill which would have taken out of the control of the Forest Service important lands in the natural forest reserves which are needed for the preservation of water power, etc., successful attempts to secure State and national appropriations for investigating the chestnut tree blight and other tree diseases; the general encouragement of scientific forestry; the establishment of forestry schools; promotion of interest in reforestation; in the development of farmers wood lots; in the organization of the State forestry associations; and (this being a most important part of the general work) in the encouragement of the closer co-operation between the lumbermen, timberland owners and



state and national foresters, for the extension of their several interests.

The Board of Directors held their last spring meeting at Saranac Lake and Lake Clear, and with a number of leading lumbermen of the state who were their guests, they inspected the state nurseries and plantations at those places, and examined closely into the practical side of the work. Similar inspections and examinations took place at the July meeting in the White Mountains at Bretton Woods. Later five delegates were sent to the Fourth Conservation Congress at Indianapolis, and there held a three day sectional meeting with some of the leading lumbermen, timberland owners and foresters of the country. The result of this meeting which I desire to explain in detail to you will be, I feel safe in saying of vital importance to every timber interest in the United States.

Let me read a general statement of what was done:

Lumbermen, timberland owners and foresters of the United States and Canada are deeply interested in plans which are under way and almost completed for a thorough investigation of a number of questions which are of vital importance to these interests. This investigation, when finished, will, it is expected, have most beneficial results as regards forest conservation, scientific lumbering, the taxation of growing timber, the practical end of the lumbering business, and general forest education.

All the associations interested in the timber business, and they include timberland fire protective associations, lumbermen's sales organizations, wood manufacturers, wood preservative, and wood working associations, paper and pulp companies, state foresters societies and state forestry commissions and associations as well as the Forest Service of the Department of Agriculture, will, it is now apparent, lend their aid in the work and all will, it is expected, secure practical benefits in return.

The work is to be under the direction of the American Forestry Association with headquarters at Washington, D.C. This is the only national association devoted to

forest conservation, and as it conducts its efforts in this direction on the broadest possible lines, it receives the support not only of those who are sentimentally interested in the conservation of this most important of the natural resources but of the men and organizations who are in one way or the other financially interested in the timber business. Being a national association, supported entirely by its membership, and the subscriptions to its monthly magazine American Forestry, it was natural that the general direction of the very important work which it is planned to do should be under its auspices.

The plan originated at the recent Fourth Conservation Congress held in Indianapolis. There, for three days, representatives of the American Forestry Association, of various lumbermen and timberland owners associations and state foresters held a sectional meeting. It was evident during the first session that practically every one present was impressed with the great need of more active co-operation between the various interests represented in the endeavor to secure the solution of certain specific problems relating to forest conservation and the lumber industry. At times in the past various ones of the organizations represented had made more or less effort to advance along the lines proposed but not with the success which was desired. The discussions had not lasted long before it became evident that the only way to secure definite results was by the co-operation of all who are interested and the energetic development of the investigations, which it is necessary to make, of the several subjects which are of vital interest to the foresters and the lumbermen.

After a three days' discussion of various plans the meeting appointed a committee composed of E. T. Allen, forester of the Western Forestry and Conservation Commission, of Portland, Ore.; Capt. J. B. White, of Kansas City, Mo., one of the most prominent lumbermen of the United States, and Henry S. Graves, chief forester of the Forest Service, of Washington, D.C., to confer with a committee named by the executive board of the American

Forestry Association, and arrange the details of the investigations which were planned.

The American Forestry Association at a directors meeting in New York on October 29, named a committee consisting of Charles Lathrop Pack, of Lakewood, N.J., the new president of the Conservation Congress, and a lumberman of national prominence; Col. W. R. Brown, president of the Berlin Mill Co., of Berlin, N.H., a prominent timberland owner and paper and pulp mill owner; and E. A. Sterling, a forest and timber engineer of Philadelphia, and one of the leading men in his profession in the country.

This committee has now outlined a tentative plan of work, which after conferences in Washington in a few days and in Portland and Seattle a week or so later, will likely be adopted. The distinct lines of activity seem advisable in the opinion of members of the committee. One involves the appointment and guidance of standing committees which shall report to a forestry section of the Fifth Conservation Congress on definite problems relating to forestry and lumbering, following careful and painstaking investigation of these problems during the next several months before the Conservation Congress meets next fall. The other is to have the program of the next Conservation Congress arranged so that a great deal of prominence and publicity shall be given to forest problems.

It is proposed that the investigating committees be composed of the leading experts on each particular problem to be examined and upon which report is to be made, that they shall collect and examine reports and evidence regarding the questions assigned them, and shall make their reports of as practical a nature as possible.

While the subjects assigned to the various committees will not be definitely decided until after the conferences at Washington, Portland and Seattle, it is suggested that among those considered of prime importance shall be forest taxation, forest legislation, forest fires, forest education, state forestry, and publicity. The committee on forest taxation would prob-

ably be required to submit a general report on existing tax laws and their influence on forest management, and to prepare model forest tax laws which can be used in advocating action by states, and as a basis for State legislation.

Forest legislation, would, it is stated, necessitate a general report on the needs of the States and Federal Governments in matters of forest legislation and a model forest law for states. As to forest fires there would doubtless be a report on the best means of fire prevention by states, by the Federal Government, and by private land owners; a recommendation of measures for extending the forest fire association plan, for giving consideration to the possibility of co-operation and standard practice between the various fire associations, and for outlining specific methods of fire control for various regions.

Under the head of forest education there would probably be required a report on the strength and weakness of the present system of forest education; what courses are needed to better fit men for practical work in lumbering, and a report on the need for ranger schools and short courses for woodsmen.

As to state forestry it is expected there would be required a general report on state forestry work and recommendations for closer co-operation and the extension of activity in forested regions.

It was proposed during the Indianapolis meeting that there should be publicity for arousing sentiment for the establishment of state forestry organizations where none now exist, the enactment of better forest taxation laws and legislation, and the creation of associations for forest fire prevention and control as well as recommendations for specific plans for publicity work in connection with timberland owners and forest fire associations.

The committees in charge of the work, will, it is expected, arrange for investigations under the foregoing heads and may add to these some others. They will also arrange for the raising of money to conduct the work, select the men for the various committees, and see that the work is conducted as directed.

It is believed by the members of the American Forestry Association and the Conservation Congress committees that the results of the work to be done during the next nine or ten months will be of very great benefit to foresters, lumbermen and every one interested in the timber business, and they hope to secure changes in the timber tax laws as well as in several important phases of forest legislation, which will at the same time encourage forest conservation and of benefit to the timber trade in general.

This is a brief outline of what is the most practical and important work our association has yet undertaken, a work in which every one interested in the lumber business should be interested and to which every one should give his support. It is apparent that the larger our membership, the greater opportunity will we have to accomplish what we set out to do, and I want to extend a general invitation to all of you who are not now members, to join, and aid in the important work which is under way.

## *Basalt Lava Beater Rolls.*

Editor Pulp and Paper Magazine:

In your issue for September you print an article on the use of Basalt Lava Stone in paper making, on page 275, and another article on "Helin's Patented Beating Material," on page 288.

Since we are practically identified with Basalt Lava Beater Rolls, and since the article on Helin's Material refers largely to Basalt Lava Stone Rolls, and contains a number of obvious inaccuracies, we write you in order to put the errors right, as far as we can.

The statements published by you on the Helin Material are already in many points contradictory to each other.

The writer of the article is entirely wrong in saying that Basalt Lava Stone causes "trouble, delay and additional expense when it wears out and requires replacing."

In the first instance, our Basalt Lava Stone Beater Rolls are made in such a way that the wear falls, practically, entirely on the bedplate. This, of course, wears, but two of them are furnished right from the beginning, so that one is always ready for use when the other requires re-trimming, whilst the renewal of these bedplates can be done at practically a nominal cost, much below the cost of the renewal of steel or any other kind of bedplates.

The life of the Rolls themselves is longer than the life of Bronze Rolls, provided they are properly used. As a matter of fact,

many Basalt Lava Stone Rolls have been in constant use for over 10 years, not only without required renewal, but which are almost as good to-day as they were when new.

If Stone Rolls are worn out, they require new Stone Segments, which can be fitted in at the paper mill, and we merely furnish the new Stones to take the place of the old Segments. Such work can be accomplished expeditiously, without any special trouble and at a reasonable cost.

It must be obvious to any reader using his own judgment that it is absurd to maintain, as the writer of the article under review does, that the Helin Material is quite as suitable as Basalt Lava Stone for beating purposes, and that the length of its life is about double, since the article goes on to show that the Helin Material has been in use for about two years only, a period wholly insufficient to demonstrate either its suitability for the various kinds of furnish to be treated, and quite inadequate to demonstrate the length of its life, as compared to our Stone.

Special reference is made to the treatment of imitation parchments accompanied by the remark that the power required and the time of beating are about the same as when Basalt Lava Stone is used.

It is well known that in suitable Beating Engines, provided with Basalt Lava

Rolls and Bedplates, imitation parchments can be made, from suitable raw material, with from one to two hours' beating time, and we send you herewith a few samples of such papers, on which furnish and beating time are marked, which were obtained under ordinary mill working conditions, without the addition of any chemicals, because we feel certain that no paper mill will be able to produce similar samples obtained from any other beating tackle, showing equal properties after so short an exposure in the beater.

The power consumption is about 15 per cent. greater than that for ordinary Beater Rolls, but since the time is so materially reduced, very frequently only a third, or even less, than the time required by other Beating Tackle is used, the total h.p. hours required are materially diminished.

It is to be regretted that the comparison which follows in your publication is made between the Helin Material and ordinary Steel Rolls with Steel Bedplates, since it would be of greater interest to have comparative data between the Helin Material and Basalt Lava Stone Rolls, which had they been given would, probably, have made this letter to you unnecessary.

Your article goes on to state that the power required with Steel knives was 70 h.p. from start to finish, and 96 h.p. from start to finish with the Helin Material. Both statements must be incorrect, since the power absorbed by the Beater varies within wide limits during the beating operation in properly constructed Beaters, is relatively small during filling, gradually increases to the maximum when the Roll is entirely down, and gradually decreases as the beating ceases and the engine is discharged. We only mention this well-known fact so as to show that what is published in your issue on the Helin Material cannot lay claim to give reliable data.

The fact that this new material is composed of very porous cast iron, is likely to set up discoloration of the stuff on many kinds of furnishes as compared to the results obtainable from Basalt Lava.

The article winds up with the admission that the material has only been introduced a short time ago, which bears out our claim

that it is much too early for a comparison of lasting properties between it and Basalt Lava.

We have no desire to detract from any merit which this porous cast iron may possibly possess, but we cannot allow the unwarranted and misleading comparisons to Basalt Lava to remain uncontradicted.—Marx & Co., London, Eng.

#### REMOVAL OF STRINGS BETWEEN THE PULP CHEST AND THE WET END.

When working up waste paper, particularly when this is not carefully sorted, strings, thread, etc., which have not been removed in the edge runner or kneading machine frequently pass on to the paper machine and can cause all kinds of damage. The string-screens may break down under certain circumstances when many strings arrive with the pulp.

A simple contrivance for removing the strings consists in building into the sand-trap a number of nails arranged close together in several rows, through which the pulp must work its way. For this purpose place transversely over the sand-trap a board 200 to 250 mm. broad closely spiked with long iron nails projecting some centimeters above the pulp. It must be remembered that for thick papers the pulp is higher. As a rule, 8 in. to 9 in. nails, such as the carpenter uses, suffice. For example, a board 250 mm. broad will have 12 to 18 staggered rows of holes bored in it. The distance apart of the holes from centre to centre may be 15 to 17 mm.

The holes must be rather smaller than the diameter of the nails in order that the latter may be firm. The nails must be knocked in so that one edge is exactly opposite to the arriving pulp. The board thus prepared is attached by catches on the bottom of the sand-trap after a corresponding number of strips have been removed. Under certain circumstances several such screens can be arranged. The boards must, of course, be removed from time to time and be liberated from the adhering strings, because otherwise the pulp will finally be prevented from passing through and the sand-trap will overflow.—Papier Fabrikant.



## Manufacture of Parchment Paper.

E. Fues, of Hanau, Germany, has taken out a U. S. patent for the manufacture of parchment paper quite distinct from the method which consists in causing concentrated sulphuric acid of from 59° to 61° Baume (or a concentrated solution of zinc chloride) to act on paper, papers made from cotton yielding the best results.

It is claimed that an equally valuable parchment paper can be produced at a reduced cost and with less danger to the operatives by using very dilute acids, organic acids, acid salts and such salts as act in a like manner through dissociation in dilute aqueous solution with, or without, the addition of formaldehyde, such substances being employed at a high temperature either in the course of manufacturing the paper, or after it has been made. In the latter case the raw paper which is used in the process can be of varied composition, the so called imitation parchment paper or greaseproof paper of the so called Mitschrelich cellulose made from hard boiled cellulose by grinding up an unctuous or viscous consistence being the most suitable for the purpose in view.

The paper is soaked in the aforesaid acid solution and then dried at a temperature of about 100° centigrade for instance on drying cylinders such as are generally used in the manufacture of paper.

If the parchmmentizing of the paper is to be effected on the paper machine, the parchmmentizing preparation must be of a strength adapted to the amount of moisture in the paper stuff at its point of application.

After the paper has been dried, it possesses, according to its composition and preliminary treatment, a more or less pronounced parchment-like constitution and resistance to the action of water.

The imitation parchment paper or grease-proof paper will be thoroughly parchmmentized in accordance with this process, the inventor says. It is conspicuously hard and when viewed through presents an appearance more devoid of structure than has been hitherto obtained by the grinding process already de-

scribed. Both these features and its resistance to the disintegrating action of water and its great power of resisting acids and alkalis characterize the parchmmentized imitation parchment paper or grease-proof paper as being fully equal in all its valuable properties to genuine sulphuric acid or zinc chloride parchment paper. For instance, ready made dry imitation parchment paper or greaseproof paper can be soaked with a mixture of a solution of about 6 per cent. solution of an aluminum sulphate and a 0.6 per cent. solution of formaldehyde, and dried in the usual manner on drying cylinders.

When using sulphuric acid, the parchmmentizing can only be obtained when the strength is not less than one-tenth of the normal, but with the simultaneous employment of formaldehyde, an acid having one-twentieth the strength of normal sulphuric acid will suffice to produce a perfect parchmmentized paper.

Organic acids exercise on similar raw material a parchmmentizing action, which however is less pronounced when formaldehyde is not present than when formaldehyde is used in conjunction with the organic acids. For instance by the action of 10 per cent. acetic acid and 0.6 per cent. formaldehyde, a very good parchmmentization of the imitation parchment paper or greaseproof paper is obtained. An essential condition is, however, that the paper should always be treated at a high temperature.

The process is equally effective whether the paper under treatment be sized, or not.

Formaldehyde can of course be replaced by its polymerization and addition products, as well as by compounds which, when suitably treated, decompose and liberate formaldehyde and such substances are to be understood as included under the term "formaldehyde."

The acid remaining in the paper after parchmmentization can be washed out or neutralized and rendered harmless in any suitable manner.

The present process differs from the usual parchmmentizing process by means of



concentrated sulphuric acid in the following respects: (1) Instead of concentrated sulphuric acid of 59° to 61° Baume only thoroughly diluted acid substances are employed, such for instance as a sulphuric acid of not more than one-tenth normal strength. (2) Instead of sulphuric acid, volatile mineral acids such as hydrochloric acid and organic acids are used together with formaldehyde. (3) Acid and other salts which are excluded entirely in the old process of manufacturing parchment paper, such for instance as sulphate of alumina, or bisulphate, can be used in this process with success. (4) Whefeas for the manufacture of parchment paper by means of sulphuric acid, pure cotton raw material having as high an absorption power as possible is preferably used, this same raw material, if not subjected to a preliminary treatment, is quite useless for the new process, moreover, imitation parchment paper or greaseproof paper is suitable as a raw material for the present process, whereas, on account of its special density and small absorption power, it was totally unfit for the manufacture of genuine parchment paper by means of concentrated sulphuric acid. (5) A high temperature of about 100° centigrade is requisite for carrying out the process.

The new process is said to offer, when compared with that hitherto in use, a considerable improvement as regards economical working, as in consequence of the employment of cheaper raw papers and cheaper chemicals, especially when the paper is produced at one operation on the machine, a considerably cheaper production of parchment paper is obtained as compared with the old process.

#### AMERICAN NEWSPAPER PUBLISHERS' BULLETIN.

Bulletin No. 2791 has been issued by Mr. John Norris, Chairman of the Committee on Paper of the above Association.

##### Prices.

Considerable paper is offered by mills. Publishers are receiving more propositions from paper companies than at any time in five years. Quotations made by paper companies in different localities within the

past week indicate that they are willing to sell news print paper of good quality on a basis of \$1.86 f.o.b. mill from New York State mills, including protection against excess damage. Openly they are asking anywhere from \$1.90 to \$2.00 f.o.b. mill, but under pledges of secrecy, they are offering the price stated. New output is coming on the market with volume and celerity. The tonnage displaced by the new machines already started is persistently offered. 25,000 tons are available, in two lots. Salesmen who declare that their companies have sold 95 to 100 per cent. of their product for 1913 are misrepresenting because those concerns are energetically soliciting new orders. Publishers are in position to insist that the paper companies meet the market during the continuance of the new contract.

##### Tonnage and Displacements.

Sixty-five thousand tons, formerly furnished to the New York World and St. Louis Post Dispatch by the International Paper Company, W. H. Parsons and Company, Great Northern, Watab, and Minnesota and Ontario Company have been displaced by the DeGrasse Mill, at Pyrites and the Tidewater Mill, at New York.

The Hearst publications are using over 140,000 tons of news print paper per annum, or substantially one-ninth of all the news print paper used in the United States. The supply of the Chicago American and Examiner (30,000 tons per annum) has been placed with the Spanish River mill, the Kenogami Mill, and five Wisconsin mills, displacing about ten Wisconsin mills. Some of the growth in tonnage of the Boston American has been placed with W. H. Parsons and Company.

The Scripps-McRae League's supply of 18,000 tons per annum has been reapportioned; the Cincinnati Post order having been shifted to W. H. Parsons and Company; the Cleveland Press order from Minnesota and Ontario to Great Northern. A six-thousand ton supply to other Scripps papers has been awarded to the Lake Superior Company at Sault Ste. Marie.

The ten-thousand ton supply of the International Paper Company to the New York World which was displaced by the

Tidewater Mill, was transferred to the New York Sun, displacing the Great Northern Paper Company on that order.

The Great Northern has displaced the Berlin Mills Company in the supply of the Atlanta Journal.

W. H. Parsons and Company has taken the order for 1913 of the Pittsburgh Leader now supplied by Finch, Pruyt and Company. The Parsons concern has taken the contract of the Providence Journal and Fall River Globe from the International Paper Company.

Lake Superior Company, at Sault Ste. Marie, has contracted with the Detroit News and Journal for 9,000 tons per annum, displacing H. G. Craig and Company.

Canadian mills have taken much tonnage in the United States market from United States mills.

#### **Importations and Exportations of News Print Paper.**

In September, 10,849 tons of news print paper were imported from Canada. The exports were 3,009 tons. Heretofore, the paper makers have been shipping out approximately as much paper as the Canadians were shipping into the United States. These figures for September show a decided balance in favor of domestic supply.

#### **Tariff Revision.**

The revision of the paper schedule by Congress next year will probably throw open the doors to free news print paper from all countries and thereby broaden to the utmost limit the market of the American newspaper publisher for his raw material.

#### **Miscellaneous.**

The hearing on the favored nation matter has been fixed by the Court of Customs Appeals for December.

The St. Croix Mill, at Woodlands, Me.; the Laurentide Mill at Grand Mere, Quebec; and other paper-making concerns are increasing their water power developments preliminary to wholesale increases in paper production.

The stock of paper on hand at the mills at the end of September was 47,231 tons, an increase of 1,243 tons over the figures for August, but less than for September, 1911.

The Spanish River Mill has bought two machines, with capacity for 55 tons per day, from a mill which had shut down and it will install them at Espanola within a few months.

---

#### **TO MAKE PAPER FROM PEAT.**

W. Hellwig and F. Hermann, German paper manufacturers, have invented and patented (in Great Britain) an improved process for making pulp and paper from peat.

The process consists principally in allowing the material to be treated to remain some considerable time in a warm solution of chloride of lime, dilute hydrochloric acid and potash or soda. When the solution has acted upon the material to a sufficient degree, which may be ascertained by taking samples and testing same, the material is removed from the solution and boiled with lime water.

The following is one example of carrying out the improved process:—10 kilogrammes of 90 per cent. calcined soda (carbonate of soda that has been partially dehydrated by roasting) are dissolved in 100 litres of boiling water. The solution is then boiled for a time, being stirred at intervals. Then 2 kilograms of chloride of lime made into a paste with water are added to the boiling mixture. To this mixture, when cool, there are slowly added 3 kilograms of hydrochloric acid of about 20 degrees Be. The resulting liquor is then ready for opening the fibrous materials to be treated which are placed in the said liquor and allowed to remain therein for about 24 hours. The liquor is preferably warmed. At the end of this period the fibrous materials are removed and introduced into a vessel of boiling water, to which about five per cent. of burned lime has been added. The fibrous materials are boiled in this thin lime water for about two hours, after which the fibrous materials are washed in clear cold water for the purpose of removing as far as possible any free chemicals. The resulting mass is then suitable for further treatment for the manufacture of paper.

## Paper Specialties.

As we have more than once pointed out, the paper industry presents an unusually large number of openings for the development of specialties, as compared with most other lines of industry. Referring to one or two examples:

The universal drinking cup is gradually growing out of use in Canada and the States, and now, wherever there is seen a water cooler there is, almost without exception, a fixture which contains a supply of small paper cups. In some cases these are provided free; in others a "penny-in-the-slot" system prevails, the combined output exceeding a million daily.

There are now about thirty states that have prohibited the public cup and others have bills pending that will either abolish or regulate its use. To meet this condition there has come the small paper cup, but so new is the business that patents have not yet been awarded on the machines that are required in their process.

The process is mechanical, the machines are driven by electrical motors, and from the time the sheet of paper enters at one side until it is delivered to the user through one of the vending cases, it is never touched by hand.

In this transition to a drinking receptacle the cup goes through a cutter, a stamping machine which shapes it, a paraffin bath which makes it sterile and at the same time fixes its shape, and finally passes through a wrapping machine.

Another article for which there would seem to be a very wide application in the near future is paper toweling, which has a great many advantages from a sanitary point of view. In this connection a patent was recently granted in the United States to F. G. Crane, of West Collingwood, N.J., which is thus described:—

This towel has a large part of its surface composed of raised absorbent material held together by strands formed of the same material as the rest of the towel, but compressed and condensed into strength and consistency and running through the

body of the towel and maintaining its form.

These towels are convenient for use in cases where for any reason laundrying is undesirable. They can be used until soiled, after which they can be burned or otherwise disposed of.

Fig. 1 is a plan view of the towel. Fig. 2 is a sectional view on an enlarged scale of a portion of same along the line 2—2 of Fig. 1. Fig. 3 is a roll towel.

Nos. 5, 5, 5, 5 are the parts of the towel which absorbs the moisture. They are

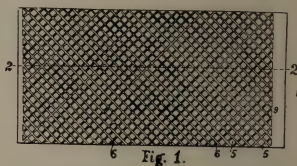

Fig. 1.

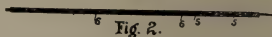

Fig. 2.

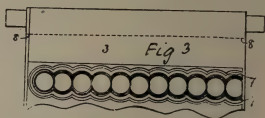

Fig. 3.

composed of soft absorbent paper and flexible as possible. These soft absorbent portions are preferably about one-sixteenth of an inch thick, but this dimension is given rather as a guide than for any other purpose. The towel is intersected by a series of fine lines of condensed material, 6, 6, 6, 6, running throughout the towel, and giving to it the needful strength, and also making it as flexible and capable of manipulation as any linen towel. These intersecting lines of condensed material can either run in a plain square or diagonal as shown in Fig. 1, or else in a fanciful pattern, 7, 7, as shown in Fig. 3.

The lines of condensed material lie depressed below the surface of the towel (see Fig. 2) and are sized and preferably finished so as to be but slightly affected by water and to continue to give the required strength to the towel while it is being used to wipe with.

The towels are conveniently provided in a single piece (see Fig 3) attached end to end and marked off from each other by a perforation 8, 8, so that they can be drawn down from a roller, detached, used and discarded. The process of making them that I employ in practice is as follows: I pass the stock through the rolls which have on either or both small pockets or depressions in which the pulp can lie, and narrow raised lines between these pockets to compress and condense the material where the strengthening lines are to be lying intermediate between the portions intended to project and be absorbent. At the same time I size and finish these depressed portions.

The ends of the towels, 3, 3, are conveniently made of the condensed calendered material and a broad cross strip, as 9, can be placed across the towel if desired.

---

#### PRINTING PAPER IN BRAZIL.

The importations of printing paper nearly doubled themselves in the six years ending 1909, rising from 8,965 metric tons to 16,406, or about 19,000 short tons. No commodity imported into South America could have more interest, one would think, for Canadian exporters; probably no other in latter years has increased so rapidly in volume. Latin American people are most assiduous readers of newspapers, and when one considers that it is not manufactured anywhere in the continent, it is natural to conclude that these southern republics present a wonderfully attractive field to Canadian paper mills. Amongst those situated on the east coast alone, it should not be difficult to sell from 1,000 to 2,000 tons a month.

The chief competitors for the Brazilian orders in 1909 were Germany, Norway and Belgium. The United States had a very small share, not much more than the Dominion, which was insignificant.

The leading South American journals, well printed on good paper, ably edited and managed, housed very often in large handsome buildings and with a foreign news service that is much more comprehensive in its scope than any daily newspaper pub-

lished in Canada, would compare favorably with the best of any country in the world. Taking the issue of the leading journal of the day on which this is written, as a sample, there found in its pages, despatches, some of them copious, from no less than 23 foreign countries, including the Dominion, which total at a rough calculation to 6,100 words. This is particularly creditable in view of the fact that cabling to South America is still very expensive, the ordinary rate to Europe is 61 cents a word and to North America 85 cents. In Rio are at least seven morning papers sold in the street, and five or six other dailies issued in the afternoon and evening. Several trade inquiries accompany this report, from firms who are well able to handle printing paper.

Canadian mills should look into the importance of this huge southern market. Even if they are not prepared to take care of any orders to-day, they may be in a couple of years. But this is not a line that can be sold by "travelers"—usually at a certain season of the year contracts are renewed or new ones made, and it consequently is necessary to have agents on the spot.

Business connections can sometimes be arranged by correspondence, but so important a veld warrants the sending of a capable representative to study the conditions, which vary to some extent with each country. This is undoubtedly a trade in which no republic should be considered separately, but all the more important ones as a whole. Paper of various classes is manufactured in the country, such as account and memo forms, colored paper, colored tissues, etc., but not printing paper for journals, the duty on which is low, being only 10 reis per kilo, equal to about \$2.93 per ton. The f. o. b. price of the German printing paper is 18s. per 100 kilos or £4 5s. 8¼d. per short ton, equal to \$20.84 per ton. The f.o.b. price of paper from the United States mills is about the same, but very little is coming from them. The price of German paper, c.i.f. Rio, is 26s. to 27s. per 100 kilos.

The wall paper having the best sale in Brazil is made in the country. Although of much inferior quality, it is cheaper in price, and from some of the samples seen



on the walls in Rio, it is not hard to believe that amongst the general class the latter quality is the chief desideratum. Later on a better demand may be set in, but it does not seem to be a wide one for the present. England, Germany, France and the United States supply the foreign-made article.

Owing to the hot climate of the middle and the northern part of Brazil, distemper is probably more suitable as a covering for interior walls than wall paper, particularly when it is desirable that no precaution should be neglected to keep every part of a building in a thoroughly sanitary state.

### ARTIFICIAL SILKS.

Artificial silk is fast coming to be a very important textile material and is being used in ever-increasing quantities by the trade. It is employed as an adjunct not only to the silk industry itself but is also being used in connection with wool and cotton in the preparation of a great variety of fabrics. It is even being used largely in knot goods and hosiery in combination with cotton and mercerized cotton.

The dyer therefore is meeting more and more with this product, and as there are three different kinds of artificial silks in general use and as these different varieties possess certain differences in structure and quality it really becomes a question of considerable importance to the dyer to know one variety from another. This is more especially important because one silk may stand a treatment which would be fatal to another.

The three artificial silks now to be met with on the market are described in a recent issue of the Wool and Cotton Reporter, as follows:

1. Collodion silk, known also as Chardonnet, or nitrosilk. It is prepared from nitrated cotton.

2. Cuprate silk, known also as Glanzstoff, Pauly, Elberfeld silk. It is prepared from a solution of cellulose in cuprammonium solution.

3. Viscose silk. This is prepared from a solution of cellulose in a mixture of caustic soda and carbon bisulphide.

In their outward appearance the three

forms of artificial silk are so nearly alike that it would not be possible to distinguish between them. Even a microscopic examination by an experienced observer does not lead to any positive conclusion as to kind of silk.

A fairly simple test, however, and one which may be easily carried out by the average dyer is the following: A sample of the silk to be tested is placed in a small porcelain dish and concentrated sulphuric acid is poured over the fibres. If the sample consists of collodion silk no coloration appears until about an hour has elapsed, when the acid solution will acquire a pale yellow color.

In the case of cuprate silk the acid becomes yellow immediately and the color becomes deeper on standing. In the case of viscose silk the acid immediately develops a reddish brown color, deepening to a rusty brown after standing for an hour.

### ESPARTO PULP.

U. S. Vice-Consul-General Young, of Genoa, Italy, says esparto pulp is not handled by importers and exporters there, as only the grass enters into the export trade. Italian paper manufacturers make the pulp for their own consumption in their factories, but esparto pulp is not exported. For the crude grass a Genoa firm informs us that it charges 120 lire (\$23.16) per metric ton f.o.b. Genoa. Esparto grass of Tripoli yields only 42 to 43 per cent. of pulp, whereas that from Tunis yields 43 to 45 per cent., that from Algeria 45 to 48 per cent., and that of Spain 55 per cent. Most of the Tripolitan esparto is exported to Great Britain, where alfa (a mixture of *Stipa tena-issima* and of *Ignum sraium*) brings 56s. to 66s. (\$13.62 to \$16.06) per ton. The leaves of the alfa of Tripoli yield 56 per cent. of the fibre and are gathered during the dry months, on account of the fact that the whole root comes up if gathered in the wet season. Careless picking of esparto grass in Tripoli by natives is responsible for a greatly curtailed output. The crop is gradually diminishing, due to the picking of roots along with the grass, which prevents reproduction.



## Tapered Fine Grinders For Groundwood.

William Denso, of Simmersdorf, Germany, has patented a form of tapered fine-grinders for the manufacture of mechanical woodpulp, a special feature of which is a series of spiral furrows so contrived as to carry the substance to be ground between the grinding surfaces. The familiar straight or curved furrows in the working surfaces of the stones of cylindrical mills that cover or cross one another are not practicable for the working cover-surfaces of the stones in tapered or conical mills, being incapable of obviating the trouble due to the high speed of revolution of the stones, in consequence

rows may also be contrived in both of the tapered or conical grinding surfaces and in a direction opposite to one another.

In the construction according to Fig. 1, of the two co-operating tapered grinding surfaces a and b, the grinding surface b is provided with spiral a screw-shaped passage furrows d, by means of which an active suction or a spiral drawing in and an effective forcing in of the substance to be ground, against the grinding surfaces, is effected. The first introduction of the substance to be ground between the grinding surfaces, can be assisted by the familiar pushing device c.

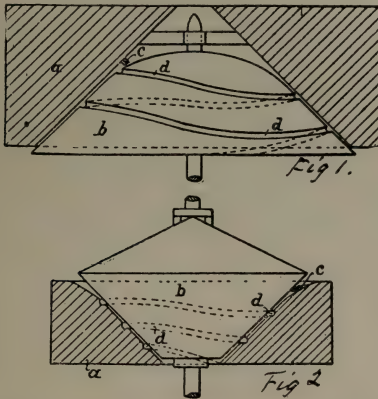

of which the substance to be ground in place of being carried toward the point of discharge, is forced back to the point of entry and consequently is not ground at all.

To obviate this, special means is demanded, for which the invention provides by contriving spiral or screw-formed channels in both the tapered grinding surfaces. By this means it has first been found possible to ensure in tapered grinders for woodpulp manufacturing, a powerful suction or a spiral drawing in and effective forcing in of the fibrous substance to be ground between the grinding surfaces. The spiral or screw-shaped winding fur-

In Fig. 2, the spiral-shaped passage furrows d are contrived in the conical face of the stone a. Where the winding furrows are contrived in both grinding surfaces, this is effected by having them run in opposite directions, so that the furrows cross. Thereby not only is an increased suction or drawing in action ensured, but a cutting of the substance to be ground by the edges of the crossing spiral furrows, and thus its more speedy reduction is assured.

The spiral or screw-shaped winding furrows shown in the horizontally disposed stones in Figs. 1 and 2, may also be arranged in stones placed vertically.

## Commercial Cellulose Chemistry\*

By Harry S. York

The literature on cellulose and its chemistry is far from being voluminous, although it has had two distinct contributions in the past two or three years in Worden's "Nitrocellulose Industry" and Schwalbe's "Die Chemie der Cellulose." Why there has not been more intimate study of the subject with more recorded data is not difficult to answer. Primarily, notwithstanding that cellulose, as the chief component of cotton, or flax, or hemp, or wood, and in fact all forms of plant life, is scattered over the face of the earth in the greatest profusion and abundance and is of the most fundamental importance to the well-being of human life, the study of its composition and reactions is really a small and highly specialized branch of the great science of chemistry. This is no reason for neglect, if the study of cellulose has indeed really been neglected, but if we stop to think of the reactive inertness of cellulose, of the great complexity of aggregates of this type, and of our deficiency of knowledge of the fundamental laws governing the behavior of such complexes, and when in addition in this particular case we also consider that the synthesis of cellulose offers no inducements to the pure chemist, it is not to be wondered at that more effort has not been concentrated on the study of the ultimate composition of cellulose, or of its exact structure. As might be expected, there has been much conjecture, much theorizing and in consequence much controversy over what the probable structural formula of cellulose might be, but the opinion is here voiced without hesitation, although others may perhaps have previously expressed it, that the available data at present is all too insufficient to justify even a serious assumption of the probable chemical structural make-up of cellulose.

Now cellulose is a material of the first order for technical application, and while it is impossible to say to what degree the

deficiency of composition data has retarded its industrial developments, it is nevertheless true that nearly every known chemical reaction in which cellulose participates has been practically utilized with much profit and benefit to the community. Realization of this fact has at last come to chemists, and the technical cellulose field is now being explored with really remarkable endeavor.

Several known facts of first importance should be borne in mind, and they are here referred to because they are pertinent to cellulose chemistry in its broad aspect, and because they have particular bearing on the proper understanding of the physical and chemical properties of the cellulose esters. These facts are: first, that cellulose is a molecular aggregate of high complexity, and in consequence can pass through various reactions with the possibility of producing an indefinite number of products of like empirical composition, but varying in the degree of aggregation and, therefore, in physical properties; second, that cellulose as such is not soluble in neutral solvents, and either acids or alkalis, so far as we now know, must be present in the different reaction in which cellulose participates; third, that all cellulose reactions seem to require, or are accompanied by, either hydration or hydrolysis, prior to, during or subsequent to, the general reaction.

To the first of these facts, complexity of the cellulose molecule, can be attributed the now firmly established precedent, that a very long period of experimental development must be expected to ensue between the discovery of a new cellulose reaction and the time when it shall be sufficiently perfected to be considered a positively demonstrated practical application, provided of course that the reaction is of that class which permits of such development and application.

Through just such a trying period has passed the nitration of the cellulose, and the formation of viscose, or cellulose xanthogenate. From a like period the acety-

\*Read at the International Congress of Applied Chemistry.

lation of cellulose has not yet wholly emerged, but now, forty-three years after Schutzenberger recorded his experiment of producing cellulose acetate by heating cotton cellulose with acetic anhydride in a sealed tube, and nearly twenty years after Cross and Bevan utilized the more reactive recovered cellulose from their viscose process as the cellulose base for acetylating, now indeed has the perfected present-day cellulose acetate become a controllable industrial material with not only its limitations but its great possibilities well recognized.

As has been stated, that cellulose could be acetylated has been known for nearly fifty years, but the real father of the modern cellulose acetate industry is A. P. N. Franchimont, who found, and publicly disclosed in various scientific journals about thirty years ago, and later, that cellulose could be acetylated by acetic anhydride with great facility provided a small amount of sulphuric acid was added to the reaction mixture, and who, moreover showed that the quantity of sulphuric acid and the conditions of the reaction influenced the physical properties of the cellulose acetate produced.

Nowadays all cellulose acetate is made by this general method of adding an assisting or condensing agent to the reaction mixture consisting of cellulose, or modified cellulose, and acetic anhydride, and the different patented processes vary either in the form of cellulose used, the nature and quantity of the condensing agent, the general reaction conditions of time and temperature and the method of recovery of the acetylated cellulose. With the exception of the Cross and Bevan acetylation method of acting on recovered cellulose from viscose by means of acetyl chloride and an inorganic acetate, essentially all the contributions to the patent literature on cellulose acetate covering the manufacture of this product have been issued subsequent to 1899, and they all follow the general basic method of Franchimont, and must therefore be interpreted as being valid within the limitations of the conditions specified, but provided of course that these conditions are true in fact, and not previously anticipated.

When cellulose is acetylated, using of necessity acetic anhydride and diluting if

necessary with acetic acid, the cellulose acetate passes into solution as fast as formed and is recovered from the solution in a powdery, granular or horny mass by precipitation with water or some other non-solvent of the ester such as a hydrocarbon or carbon tetrachloride.

Prior to about seven years ago the granular, amorphous forms of cellulose acetate was the only variety known, but about 1905 it was learned that the acetylation could be conducted in a bath in which the ester was insoluble, and the product so produced retained the general physical form of the initial cellulose material, so that if cotton yarn is used, the end product is cellulose acetate yarn.

A process of this character has positive inventive features which are obvious and which do not pertain to any of the other processes, such as producing acetylated celluloses of fibrous or other specific forms and the ease of solubility, but it has also other advantages which are not obvious. Among these are ease of control, with the possibility of standardization of products, practically theoretical yield, and the ability to retain the molecular aggregation of the cellulose to a far higher degree than seems to be possible by any of the solution processes. This last is of fundamental importance because the degree of aggregation primarily determines the strength of the commercial products which can be made from the cellulose acetate.

On this account, if for no other, it is believed that the cellulose acetate of the future will all be made by the fibrous method. Fortunately a relative measure of the aggregation is to be had in the viscosity of solutions of cellulose acetate in a standard solvent.

Cellulose compounds in general show so many solubility-peculiarities and possible property-variations that it is not to be expected that the acetylation of cellulose is by any means a simpler procedure than nitration for instance. Speaking particularly of the fibrous acetylation of cellulose, it requires careful adjustment of the proportions of reagents, of the time and temperature conditions and of the character of the original cotton to be acetylated in order

to secure the maximum control of product which the process affords.

Referring entirely now to the process of preparing fibrous cellulose acetate in a high degree of aggregation,—in the first place the cotton cellulose to be acetylated must be carefully prepared and not structurally weakened by the cleansing or bleaching process. This high grade cellulose is then subjected to a preliminary treatment with acetic acid, water and a condensing agent, as for example sulphuric acid, under particular conditions whereby, as far as we know, the cellulose is hydrolized so that one molecular of water is added for every thirty-six atoms of carbon, or for every six groups of the formula representing the empirical composition of cellulose as follows:

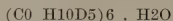

This initial hydrolisis seems to be essential for a controllable acetylation, and the conditions of the hydrolisis are vitally important. After the preliminary treatment, the excess of reagents is removed mechanically and the acetylation proper takes place in a bath consisting of acetic anhydride and a restraining agent, usually benzol, but the bath otherwise modified in a way which technical experience has demonstrated as being advantageous for producing the best quality of cellulose acetate. The temperature is carefully controlled throughout the acetylation, and all the other conditions are adjusted from start to finish, so that the end product shall be cellulose triacetate of desired solubility and viscosity. Compared with most chemical reaction, the process is a slow one, for it is rarely inside of eight hours, but best results are not usually obtained by an acetylation which takes much less than eighteen hours. The reaction proceeds so slowly that at any time during its course a small sample can be removed and tested to see if it meets specification. When the acetylation is complete, the mixture of acetic acid and benzol is drained from the cellulose acetate, which is thoroughly washed free from acid and dried and the acetic and benzol can be separately recovered by distillation or otherwise and utilized again. During acetylation, the fibre bulks up greatly, which is expected when it is realized that the original cotton increases approximately 75 per cent. in weight in its con-

version into cellulose triacetate. Theoretically, 100 parts of dry cellulose should yield 178 parts of cellulose triacetate, and in a properly conducted fibrous acetylation practically this yield is regularly acetylated cellulose was tetracetate of cellulose, but now it is generally conceded that the maximum degree of acetylation obtainable corresponds to cellulose triacetate. The mistake has been in part due to saponification methods. By boiling with half-normal alcoholic potash solution, saponification values are frequently obtained which correspond fairly closely with calculated figures for cellulose tetracetate, due undoubtedly to further decomposition of the cellulose by the alkali. With half normal alcoholic potash diluted with an equal volume of water, true values are obtained after one to two hours' boiling. This seems to be a rapid and accurate method.

A point is here recorded as being of interest in the pure study of cellulose chemistry. It does not seem possible to acetylate cellulose directly by acetic anhydride alone without a condensing agent, except at very high temperature, and then there is some question whether at these temperatures the cellulose is not subjected to partial decomposition whereby the reaction is enabled to take place. This occasions some doubt as to whether there are in normal cellulose any free hydroxyl groups, which uncertainty is by no means clarified by the observation that cellulose recovered from cellulose triacetate by saponification does not seem to be any more easily acetylated by acetic anhydride alone than is the original cellulose.

As nearly all the practical applications of cellulose acetate require it to be either gelatinized or dissolved, the solvents of cellulose triacetate are a matter of primary consideration. These solvents are not generally the same as those of cellulose nitrate and there are relatively few in common. In the main, the chief solvents of cellulose acetate are of two classes,—chlorine compounds and phenols. There are a number of other solvents outside these classes, among which is acetone. The question of acetone solubility will be taken up now because it introduces another peculiarity of cellulose acetate. If the acetylation is brought about



by a relatively small percentage of condensing agent, as for example sulphuric acid, the cellulose acetate produced thereby will be only slightly, if at all, soluble in acetone; if the percentage of sulphuric acid is increased, the solubility in acetone is increased. Better yet, if after the cellulose acetate has been formed it is digested for some time with aqueous solutions of mineral acids of moderate strength, it will become entirely soluble in acetone. Because, after acetylation, the cellulose acetate is always immersed in water to free it from the acids used, the above described after-treatment always takes place in the practical manufacture of cellulose acetate, and because it takes place more rapidly when the aqueous acid is stronger, accounts in a great degree for the fact that cellulose acetates prepared with a larger percentage of condensing acid show greater acetone solubility than those prepared with only a relatively small amount. The change to acetone solubility has been inferred to be occasioned by hydration or hydrolysis of the ester, but no concrete data has as yet been advanced to verify this inference. This is true, however, that the acetone soluble cellulose acetate shows a wider range of solubility in other solvents than does the kind not soluble in acetone.

Returning now to the two general solvent classes previously mentioned; of the chlorine compounds, chloroform and tetrachlorethane or acetylene tetrachloride are the most important, the latter being a much more powerful solvent than chloroform. Methylene chloride, ethylene chloride, epichlorhydrine, dichlorhydrine, methyl chloracetate, ethylenechlorhydrine, acetochlorhydrine, ethyleneacetochlorhydrine, dischlorethylene, trichlorethylene are some of the other chlorine solvents of varying degrees of solvent power, some of them only solvents of the acetone soluble acetate and some only exercising solvent power in the presence of limited quantities of methyl and ethyl alcohols. Neither methyl nor ethyl alcohol is, strictly speaking, a solvent of cellulose acetate, but these alcohols added to most of the chlorine solvents increase marvelously the solvent power of the solvents, creating in some of them general solubility where otherwise it is limited to certain kind of cellulose acetate, and

causing in the case of others marked decreases in the viscosity of the solutions, with the possibility of producing flowable solutions of high concentrations. The viscosity reductions are, however, not so great with ethyl alcohol as with menthyl alcohol.

Phenol, or carbolic acid, is perhaps the most powerful of all the solvents of cellulose acetate, but other phenols like cresol thymol, guaiacol, carvaerol, benzyl phenol, amyl phenol, and resorcin are also excellent solvents. One measure of the solvent power of a phenol is the degree to which a given cellulose acetate solution in it can be diluted with benzol without causing permanent coagulation. Most peculiarly, ethyl or methyl alcohol cannot be added to phenol solutions of cellulose acetate to anywhere near the extent that benzol or its lower homologues can be added.

Of some of the other fairly strong solvents mention might perhaps be made of formic acid, acetic acid, pyridine, aniline, methyl formate, methyl lactate and methyl and ethyl acetoacetate. There are also perhaps a few solvents of very limited solvent power acetate and ether alcohol mixtures, ordinary solvents of cellulose like diacetone alcohol and methyl and ethyl acetates. Amyl nitrate, are not solvents of cellulose acetate.

It is not the intention of this paper to discuss at any great length the commercial applications of cellulose acetate, and yet perhaps a few words on this branch of the subject may be of interest at this time. Cellulose acetate is essentially adaptable for the manufacture of all the products for which cellulose nitrate fulness. Many of these uses are now in the course of technical development, coincident with which is a gradual lessening of the cost of production.

It will not be very long before the highly inflammable and hazardous celluloid moving picture film will be entirely preplaced by the safe cellulose acetate film. A step has been made already in this substitution, and were it not perhaps for unpreparedness and monopolistic suppression the substitution would be complete by now.

As an effective insulation of very fine wire, cellulose acetate has been technically applied for over ten years, having certain mechanical advantages possessed besides



only by cellulose nitrate, but having the additional virtue of far greater stability and permanence at much higher temperatures. For the manufacture of waterproof artificial silk and imitation bristles, cellulose acetate is unique. The nitrate is not at all suitable for these purposes because of its hazardous inflammability in the necessarily fine state of division of the material in these applications, and if the inflammability is removed by denitration all the waterproof properties are also lost. For the manufacture of ready mixed bronze and gold paints, a cellulose acetate solution in acetone is peculiarly suitable, while cellulose nitrate solutions are not, particularly because the latter corrodes bronze powder, while the nitrate is too hazardous to use. It is expected that ultimately cellulose acetate will substitute effectively for many of the present applications of celluloid, but it is not intended by any means to convey the impression that celluloid will ever be completely eliminated, for it certainly has many uses for which cellulose acetate cannot be adapted, just as there are many more applications than have been mentioned in which cellulose acetate products will have a distinct field of their own.

---

#### MANUFACTURE OF SMOOTH-FACED PAPERS.

For papers having one smooth side a sulphite cellulose not too softly boiled and free from resin is most suitable. With too high a percentage of resin it is impossible to keep the drying-cylinder thoroughly smooth; green wood should therefore not be employed at all for papers having one smooth side. Beating is effected with sharp knives, a narrow bed-plate, slight loading, and a small charge (not above 5 per cent. density); the pulp must be beaten quickly. Papers containing no wood should be manufactured without straw pulp and without loadings. In bleached pulps the chlorine must be entirely removed by washing, or else the smoothness of the cylinder is affected. For sizing it is best to avoid starch, water-glass and the like.

To obtain thorough smoothness it is important that the sheet be of uniform thickness throughout. The pulp on the wire is therefore worked with as much water as possible, good shaking, and to some extent with the dandy-roll. The wet felts and couch-roll jackets must be finely woven, as otherwise the form of the web is rendered visible on the smooth side. For papers smooth on one side two wet-presses usually suffice. Two cylinders of 1,250 mm. diameter are necessary for the preliminary drying. The smoothest surface is obtained when the paper, on reaching the smoothing cylinder, has 45 to 50 per cent. dryness. It is also important that the paper be then as warm as possible.

In order to keep the cylinder bright three doctors should be employed: (1) a bronze doctor, 2 to 3 mm. thick, as nearly as possible at right angle to the cylinder, and most carefully fitted to it. The sharp edge which forms in front of the doctor is usually removed by a fine smooth-file, the doctor being then raised from the cylinder; (2) an unhardened steel doctor, 5 to 6 mm. thick, and covered with fine emery cloth; this must very frequently be changed; (3) a doctor of the same metal as 2, but covered with wet felt, preferably of the best couch-felting.

As soon as the strip of felt gets dry, it must be cleaned and again moistened. The press roll should be fitted with a rubber jacket and felt running between the roll and the cylinder. With proper treatment such a roll will last for years. The roll must be carefully fitted to the cylinder, and a light pressure is then sufficient. The shower-pipe which keeps the roll damp must be supplied with clean water, because should any holes be stopped up the unmoistened places so caused will become brittle. The felt running round the rubber roll must be of a fine web, and weigh 200 g. per sq. m. The rolls must be pressed against the cylinder by a lever, so that the pressure can at any moment be quickly removed. Finally, it is important that the material employed for the smoothing cylinder be hard, dense cast-iron, because only with this is a good, smooth surface obtainable.

## Electric Drive for Paper Machines\*

By J. S. Henderson, Jr.

The satisfactory solution of any electrical problem is the result of a careful study of the conditions to be met and the application of the best apparatus available that will meet, or most nearly meet, the specified conditions. Every paper machine has slightly different dimensions or requirements and a special investigation is necessary for each before the best type and characteristics of drive can be determined upon. But regardless of the fact that each machine has its own peculiarities, the general operating characteristics are sufficiently similar so that they may be treated as a class in this paper. The fourdrinier machine is probably adaptable to the manufacture of the widest range of weights and grades of paper and, being in much greater use than the cylinder machine, will be considered exclusively.

Although complex in structure, the principle of operation of a paper machine is quite simple and consists essentially of the separation of the paper fibre from its suspension in water, first by wire gauze, then by pressing and drying. The principal parts of the paper machine are: the wire, which is driven by the couch roll, the press rolls, the dryers, the calenders, the reel and winder. These constitute that portion known as the variable speed part of the machine while the various stuff pumps, vacuum pumps, screens, shake, etc., are driven at constant speed and constitute the constant speed portion of a machine.

A certain range in speed is necessary on the variable speed part of a paper machine in order to manufacture various weights and grades of paper and even if only one weight and grade be made, a small speed range is desirable to take care of varying conditions and obtain maximum production at all times. The speed range required may be as small as 25 per cent. or as great as 10 to 1, depending upon the class of output. Theoretically, the tonnage output should be

constant at all speeds, but manufacturing conditions usually modify this so that the maximum production is obtained at some intermediate speed. The limiting features may be either in the forming, drying or handling of the paper. Considering the theoretical condition of constant production at all speeds, the thickness and weight would then vary inversely as the speed of the machine for a constant width of paper. From a paper-making point of view there are three characteristics for a successful drive, viz.:

1. Entire speed range by simple and positive control.
2. Good speed regulation at any speed.
3. Uniform angular velocity at any speed.

Speed regulation is important, since variation in speed means variation in weight, but the regulation need not be considered from no-load to full-load. Variation in load may be caused by throwing off or on the winder or other sections of the machine, but it is easily seen that if the dryers or any part before them is shut down, paper is not being produced and consequently it matters little what the speed variation is. In view of this fact it is customary to take the regulation between certain load points, as explained later.

It is also necessary to know how the load or the torque varies over the entire speed range in order to satisfactorily design a motor for this purpose. The greater part of the load of a paper machine is bearing, gear and belt friction, and when running without paper the torque required would be expected to be approximately constant, and the horse power varying in proportion to the speed. The effect of paper in the machine is to materially alter the speed-torque curve.

As previously mentioned, the thickness of the paper may be considered as inversely proportional to the speed, and it may also be assumed that the finished product always contains the same percentage of moisture. Then for a constant tonnage

\*Read before the Amirecan Institute of Electrical Engineers at Boston, 1912.

the same amount of water must be extracted at all speeds either by the presses or on the dryers. The drying surface is constant and the temperature cannot be materially increased without injuring the paper, but since the thicker paper is on the dryers a proportionately longer time than thin paper, it might appear that the same amount of water could be evaporated. A study of this proposition shows that drying takes place differently in a thin sheet and in a thick one. In the thin sheet considerable water is evaporated through the sheet while in contact with the dryer, the remainder passing off between the dryers, while with a thick sheet practically all of the water is evaporated by heating alternate sides of the sheet and then exposing to the air between the cylinders. The conductivity of the surface of the thick sheet gradually decreases as it becomes drier, making it more difficult for the moisture to escape, so it becomes very evident that if the production is to be maintained more water must be removed before the paper reaches the dryers.

More water may be removed on the couch by increasing the vacuum and on the presses by increasing the pressure. A higher vacuum on a flat suction box adds very materially to the torque required to draw the wire over it, and additional weights on the press rolls also increase the torque required to drive them. Heavy paper also requires more torque on the dry end of a machine, both in the calender and on the reel. Summing up the speed-torque curve of a paper machine, we find, first, a nearly constant torque portion consisting of friction and, second, a portion whose torque increases with decrease in speed, but not in the same ratio.

Probably the first drives on paper machines were water wheels or constant speed engines which were designed either for coupling or belting to the line shaft. Speed control is usually obtained by throttling and variable cut-off, but even under these conditions it is difficult to obtain good regulation over a wide speed range and especially difficult to obtain uniform angular velocity. A flywheel designed for full speed has only 1-36 as much effect

at 1-6 speed, so twin-cylinder or even four-cylinder engines with various arrangements of cylinders are now being used to overcome this difficulty.

One of the first types of motor drive consisted of a constant speed induction motor replacing the constant speed engine, but using the same form of variable speed transmission. This drive was the outcome of a desire to centralize the generating equipment in one plant, thus eliminating the maintenance and attendance of several small engines. The improved speed regulation and angular velocity were also of importance, although about the same amount of power was consumed. The variable speed cone drive motor may be started and stopped from any convenient place in the machine room, but all speed control is obtained from the cones.

It has been found that for machines which manufacture one product only, as for instance, "news," that only a small speed range is necessary and that this may be obtained satisfactorily on wound rotor induction motors. After a new machine and its crew are well broken in, it is generally possible to adjust the driving pulley so that practically all operation is at the highest motor speed. The poor speed regulation and uneconomical operation of the wound rotor motor when operating upon resistance, make it unsatisfactory for wide speed ranges and the use of a direct-current motor becomes necessary.

Since practically all paper mills avail themselves of the advantages of the induction motor for the general mill drives, a special direct-current supply for the machine is necessary. This generator may be driven by some form of prime mover, either engine or turbine, or a motor-generator set with either a synchronous or an induction motor may be used. There are many advantages in the use of a motor-generator set and especially with a synchronous motor. The following are some of the more important advantages:

1. Speed independent of load and depending upon frequency of supply circuit only.
2. Extreme simplicity and small amount of attendance and maintenance required.

3. Small floor space required, and may be placed in any desirable position, generally near the paper machine motor to save wiring and voltage drop.

4. May be run at high power factor or used for power factor correction.

Induction motors for this service have very small slip and good power factor, but are affected by the voltage of the circuit as well as the frequency and cannot be used to improve the power factor.

With a direct-current motor there are two methods of varying speed; one by varying the field current, and the other

by varying the impressed armature voltage. The first method permits of carrying approximately constant horse power at all speeds, while the second method gives approximately constant torque, or the horse power is in proportion to the speed. It has been previously shown that a paper machine requires neither constant horse power nor constant torque, so it is necessary to investigate these two forms of control in order to see which is best adapted and also what modifications may be made to obtain the most satisfactory equipment.

## Determination of the Intensity of a Color

(Translated By C. E. Bandelin from *Wochenblatt Papierfabrikation*)

Of two colors, to be compared, exactly the same quantities, usually 5 grams, are weighed, preferably on a chemical scale. The samples are dissolved, each in a 1 litre volumetric flask, which afterwards is filled to the mark. Now the same quantities of pulp, but 20 grms. bleached cellulose, if at hand, stirred up in 5 litres of water, are colored with 100 ccm. of the thoroughly stirred up mixtures and samples are prepared. These can be made on a small hand-sieve, but it may be satisfactory to pour out some of the pulp on the side of the paper machine wire. The samples must, of course, be dried before being compared. If the paper colored with the color to be tried looks darker, so should for the next experiment correspondingly less, say only 60 ccm. be taken for 20 grms. of the same pulp. Then the third experiment with, for instance, 65 ccm. of the solution, may give satisfactory results, i.e., the sample, which has been made with 65 ccm. of the experimental color, has the same intensity of color as the sample colored with 100 ccm. of the standard sample color. On the other side, if the samples of paper colored with the experimental color had turned out too light so must correspondingly more, perhaps 140 or 135 ccm. of the solution be taken. The experimental color is, expressed in per cent., in the first case  $100-65=35$  per cent. stronger; in the second case,  $135-100=35$  per cent. weaker than the standard sample

color. The method leads the papermaker, who is accustomed to notice small variations of color, to very exact results, of course, provided the experiments are carefully executed.

Still simpler is a third method, which can be used for colors, when one soluble in a can can be stirred up in water. Color solutions of 5 grms. p. litre are here used. 10 ccm. of each of the both solutions are then taken and diluted to 1 litre in two high cylinders, though common flasks also can be used. An eventual difference in the intensity of the color can be seen when looking through these very diluted samples. It is, however, better to look from above through the liquid on a piece of white paper, but with some writing on. The gradation of the colors to an even intensity is accomplished according to what previously has been said, but only cubic millimetres must now be added to or subtracted from the solution of the experimental color, according to its being weaker or stronger than the standard sample color. The calculation of the percentage is the same as before. Also this method gives most exact results.

For long there has existed a practical and useful instrument to determine the intensity of a color and the percentage of different colors when mixed. The apparatus decomposes the colors of transparent or not transparent objects into their constituents, i.e.,



in the fundamental colors, red, yellow, and blue.

In one end of a rectangular, about 18 in. long, cardboard tube, are three openings, which are covered with color filters. One of these filters consists of red, the second of blue, and the third of yellow glass. Each of the openings has an adjustable slide, and the size of the opening left open can be observed on a scale. The instrument indicates, for instance, for a color such as purple 50 per cent. red, 5 per cent. yellow, and 45 per cent. blue. In this way it is possible at any time to obtain the same color, if the slides are again set in the same places.

In the other end of the tube is an ocular, and halfway in the tube a convex glass in connection with a prism. The glass is located so, that the light from the color filters only passes through one-half of it. The color to be matched is now observed through the other half of the convex glass, and the slides in the color filter are moved until both halves of the glass show same color. The influence of the illumination is eliminated by proper means.

The first color filter of this kind was used in 1909 in the laboratory of A. D. Little, in Boston, and has since been used there with satisfactory results. It has been of good assistance to the color matcher and papermaker, because it makes it possible to determine each color in figures. By means of it, it is possible to give exact prescriptions for the coloring even without experimenting.

The apparatus is manufactured by F. C. Lee in Boston, Mass.

#### MANUFACTURE OF ACETATE OF CELLULOSE.

The main difficulty in the way of making this important substance has hitherto been the cost of the anhydrous acetic acid required. A method has now been discovered in which the anhydride is formed as it is wanted. In this way two important advantages are secured.

For one thing, the anhydride acts in the nascent state, and therefore more effectively. Again, money is saved, the materials are comparatively cheap, as ordinary acetic acid is used. The cellulose is

acted on in a bath of this acid by tetrachloride of carbon and concentrated sulphuric acid. These dehydrate the acetic acid, and at the end of the reaction the acetate of cellulose is precipitated simply by adding water. After filtration, the liquid is distilled, tetrachloride of carbon passing over with water, and sulphuric acid remaining behind in the retort.

Thus the vitriol and the tetrachloride very seldom require renewal, the main cost of the manufacture falling on the acetic acid only. For example, 100 lbs of cellulose are heated with 2,000 lbs. of acetic acid, 250 of concentrated sulphuric acid, and 1,000 of carbon tetrachloride, to 65 degrees C. for one hour. After the expiration of that time the reaction supplies all the heat wanted.

#### PROGRESS OF NEW BRUNSWICK.

Lieutenant-Governor Wood, of the Province of New Brunswick, has recently been a visitor to Montreal. In an interview, he stated that the Province of New Brunswick is more prosperous than at any time since the outbreak of the American civil war. Farmers are prosperous and are receiving good prices for their produce, land is increasing in value, the pulp and lumber industries are flourishing and railway expansion was going on at an unprecedented rate. Speaking more particularly of the pulp and lumber industries, he stated that the Grand Falls Power and Pulp project is going ahead rapidly and other projects of a similar nature were being put under way in other parts of the Province. The lumber industry was also showing a considerable improvement and altogether the Province was in a very prosperous condition.

Price Bros. started one of their generators about a week ago, and have just started the first paper machine manufacturing newsprint paper. The mill is one of the most up-to-date print mills on this side, and will receive a further illustrative description in our next issue. Mr. Geo. F. Hardy of New York is the engineer.



## Death of the Hon. J. D. Rolland

The sudden death of the Hon. J. D. Rolland came as a distinct shock to business men throughout Canada, but it was among his associates in the paper industry where his loss was most keenly felt.

The late Mr. Rolland was probably the best known French-Canadian business man in the Dominion. His interests were very wide, covering many phases of the financial, commercial and industrial enterprises of the Dominion. He was also interested in educational and philanthropic work. It was, however, as head of the Rolland Paper Company that he was best known. For thirty years he was closely identified with this business, and saw it grow from its foundation in 1883 by his father, the late Hon. J. B. Rolland, to its present large dimensions. At the time of his death he was president of the Rolland Paper Company, and had the satisfaction of knowing that it was one of the best organized and best known paper-making companies in Canada. A few months prior to his death, Mr. Rolland united the Northern Mills Company, of which he was vice-president, with the Rolland Paper Company, of which he was president. In addition to being head of the Rolland Paper Company, the late Mr. Rolland was intimately associated with many other enterprises throughout the Dominion. At the time of his death he was president of the Bank of Hochelaga, with which institution he was connected as director or president for 22 years. He was also an ex-president of the Canadian Manufacturers' Association, being the only French-Canadian to occupy that responsible position. He was also a director of the Manufacturers' Life Association, was founder and president of the Societe de Colonization et de Repatriement of Montreal, one of the founders, and at the time of his death a member of the Board of the Commercial Travelers' Association, president of Le Cercle de la Librairie Franco-Canadien, governor of Laval University, president of the Northern Colonization Company, a director of the Empire Typewriter Company and a member of the Mount Royal and Lafontaine Clubs.

He was also for many years a member of the council and later Mayor of the municipality of Hochelaga, and after its union with the City of Montreal, became a member of the City Council. For many years he was chairman of the Finance Committee, and took a prominent part in directing the policy of the City Council. As a matter of fact, his interest in civic affairs never ceased, and up to the time of his death he was a member of the Citizens' Committee and an active supporter of all reform movements in civic matters.

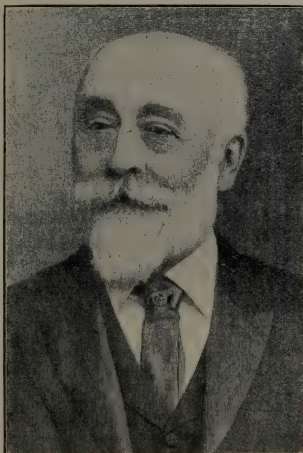

*The Late Hon. J. D. Rolland*

The late Mr. Rolland was also a member of the Legislative Council of the Province of Quebec. In politics he was a Conservative, but was extremely broad-minded, and numbered among his friends large numbers of men in both parties. He is survived by a widow, four sons and four daughters. The business of the Rolland Paper Company is being carried on by his sons. In a remarkable sense, the late Hon. J. D. Rolland died full of years and honor. He was in his 71st year.—J. C. R.

## Pin Holes in Thin Papers

By P. Ebbinghaus (Translated by C. E. Bandelin from *La Papeterie*)

By "pin holes" are usually understood the hardly visible holes, which sometimes occur in paper and which may have been caused by several reasons without any pin having had anything to do with their formation. These "pin holes" can cause serious inconvenience and also be of no importance whatever, depending upon the use of the papers. So, for instance, paper for cigarettes must be absolutely free from these holes, as well as very thin printing papers. The last named kind must not let any color pass through, as even a perfect sizing would not be of much use, if numerous channels offered an easy passage for the color to the other side of the paper. The most important points, to which the manufacturer's attention has to be directed in order to prevent the occurring of "pin holes" are the following:

*The Wire Cloth.*—Don't let any rosin spots or other impurities stick on the wire. These spots cause the paper to become thinner where they occur, which very often causes the formation of holes, when the paper passes over the suction boxes. The best way to prevent them is to use finely emulsified size milk, according to Arledter's system and diluted so that it does not contain more than 10 grms. of rosin pr. litre size. Even if the weakened spot does not break, it may nevertheless let the color pass through.

*Foam.*—Prevent everything that could favor the formation of foam, both during the manufacture of the size and at the inlet for the backwater. The size milk should be poured into the beaters cold and first immediately before emptying them. Pulverizers for water or steam give good services on the machine for preventing foaming. The use of a dandy roll is advisable, as it gives a better surface to the paper, which is a valuable quality for many grades.

*Water Drops.*—The best way to prevent water drops from falling on the paper is to blow hot air into the machine room. All other means are insufficient.

*Seams on the Wire Cloth.*—The best seams give out after some time and the

ends of the wires are bent and perforate the paper. There is no other remedy than to change the wire cloth when required.

*Dandy Roll.*—Must be kept in good shape; the meshes must not be clogged up.

*The Presser on the Machine.*—The wet press is, everywhere, where the Millspaugh suction roll has not replaced it, an especially dangerous device as to the forming of holes in the paper, on account of the impurities which may stick to the manchon, in spite of the doctor. The couch roll should follow immediate behind a suction box.

*Dryers.*—The surface of the cylinders ought to be brilliant; heat them up well, especially when starting. Look after the doctors so that they are in good contact with the cylinders.

*General.*—A condition, sine qua non, is, of course, the purity of the water used. The beaters and the paper machine should have good, sufficiently big rifflers in order to eliminate all heavy particles suspended in the pulp. This is especially important for papers to be calendered. The refining is also especially important, above all, in the manufacture of tissue and cigarette papers. It is well known that consumers do not accept these grades, if they have lots of small holes. Further, may be mentioned paper to be used for the wrapping of photographic plates, where the occurrence of "pin holes" must be absolutely prevented, as is easily understood.

---

### M. A. CARROLL.

Mr. Carroll has just come to Canada and has been appointed by the Toronto Paper Co., Cornwall, as general superintendent. He has had a wide range of experience in the manufacture of the higher grade papers on the American side. He was born at Montague, Mass., where he commenced his paper career with the Montague Paper Company. After spending fifteen years there he went with the Eslech Paper Co., as machine tender, remaining one year; then to the Holyoke Paper Company for two years in the same capacity. After

spending one year with the Nashwak River Paper Company of East Pepprell, Mass, as machine tender, he joined the Eastern Manufacturing Company, South Brewer, Me., as night superintendent. At the end of four years he became assistant general superintendent of their plant three years ago.

This firm makes the highest qualities of bleached sulphite, loft-dried, super-calendered and plated papers; and is recognized in the industry as one of the most up-to-date companies on this side.

The Pulp and Paper Magazine extends congratulations to the Toronto Paper Company for having secured such a competent superintendent, and heartily welcomes Mr. Carroll to Canada.

#### GLAZED COATED.

The Barber Paper and Coating Co., of Georgetown, have further added to their output glazed coated paper in white and colors. For this they have installed a stock of friction calenders—a chilled steel roll revolving at high speed with a pressed cotton roll at low speed, which gives a friction glaze to the sheet passed between.

Their sheets show as uniform a surface and color as any of the German import, which, heretofore, has catered to the Canadian market, and we bespeak for them success in their newest departure.

The German firms in this line are especially active just now, and are seeking to close next year's contracts, in anticipation of labor troubles in the fatherland. They hope to fill their contracts before that overtakes them.

The Magazine calls attention to this, that our wholesalers and users of this grade, who may not be aware of this newest product of a home mill, may give one of our own mills an opportunity to figure in the contracts now being closed.

#### FOREST WEALTH OF QUEBEC.

A big lumber transaction took place in Montreal this week, when the York River and Gaspé timber limits, formerly the property of the Gaspé Lumber Company, were sold to the Dalhousie Lumber Company of Dalhousie, N.B., for the sum of \$240,000 cash. These limits form part of the assets

held by the Charing Cross Bank at London.

The report of the Minister of Lands and Forests in the Province of Quebec for the fiscal year ended the 30th June, 1912, showed total receipts of \$1,658,457, while the expenses for the same period were \$317,300.

It was pointed out in the report that the number of acres of land surveyed and divided into farming lots was 6,468,368 at the close of 1911. The sales of portions of those lands during the past year netted the sum of \$53,669, and the amount collected on these and previous sales amounted to the sum of \$66,076, and, despite the sales made, the remainder of the land, together with that surveyed last year and now ready for sale or concession, reached \$7,066,755.

The principal revenues of the department are on cutting rights and stumpage dues, and these, respectively, returned \$323,584 and \$1,173,393, and, with other minor revenues, bring the total to \$1,533,474.

Commenting on the revenue, Hon. Mr. Allard made reference that the change made in the tariff relative to ground rent and stumpage dues was responsible for a surplus of more than \$400,000 over last year, despite the fact that the quantity of wood cut was less.

During the year the fact that the correspondence end of the department was very busy, was demonstrated by the fact that 27,236 letters were received and 78,479 sent out.

The Chicoutimi Pulp Co. has finished a dam three miles above the present ground-wood mills on the Chicoutimi River. The penstocks have been just completed by the Petroleum Iron Works, Ltd., and the water-wheels are about to be installed by the S. Henry Morgan Company. The design of the power house and development is by Hardy S. Ferguson, New York. The plant will be in operation by the spring to supply light and power to the Town of Chicoutimi and to the company's mills.

## Norwegian Imports of Pulpwood

C. E. Sontum, Canadian trade agent at Christiania, reports as follows:

Some years ago the Norwegian pulp mills commenced to import pulp wood from Russia. The purchases, however, for a start were rather small, as only a few of the Norwegian mills were then buyers. The Norwegian mills only commenced to buy from Russia in 1911 to any large extent, when not only the larger but also a number of the smaller mills found it to their advantage to buy Russian raw material for the production of pulp and paper.

The purchases of the Norwegian mills are principally made from St. Petersburg, but also from the Russian seaports Aarchangel, Libau and Windau considerable quantities are bought. From St. Petersburg alone the Norwegian mills bought, during the winter 1910-11, about 70,000 English cords for delivery during the season 1911.

The export from Russia to Norway of aspen wood dates much farther back than the export of raw material for wood pulp. The Norwegian manufacturers of matches have for a longer period turned to Russia for their supply. The total import of aspen wood for match-manufacturing from Russia to Norway amounted, in 1911, to about one-half million English cubic feet.

### Export of Wood from Norway for the Years 1902-1911.

Year.	Cubic Meters.	Value in dollars.
1902.....	1,961,722	10,207,786
1903.....	2,132,722	11,865,706
1904.....	1,797,122	9,413,173
1905.....	1,849,717	9,309,986
1906.....	2,027,864	11,960,106
1907.....	1,897,063	11,712,453
1908.....	1,596,125	9,266,400
1909.....	1,333,842	9,245,653
1910.....	1,253,321	9,728,880
1911.....	1,187,028	9,111,493

### Import of Wood from Russia to Norway for the Years 1907-1911.

Year.	Value in dollars.
1907.....	128,000

1909.....	473,520
1910.....	838,053
1911.....	1,528,933

Meanwhile most of the St. Petersburg exporters had sold considerably more than they could procure, and as the freights suddenly rose the consequence was that many, if not all, of the St. Petersburg exporters found themselves unable to fulfill their contracts, and instead of the 70,000 English cords only about 40,000 were shipped to Norway.

For the year 1911 the prices were as follows:

For half-clean spruce logs from 65s. 3d. to 66s. per English cord, c.i.f. Norway.

For all clean spruce logs from 68s. 3d. to 71s. per English cord, c.i.f. Norway.

For delivery during 1912 some of the larger Norwegian mills have also bought considerable quantities, while the smaller mills apparently have not been able to join in the steadily increasing competition with other foreign purchases of Russian raw material. While last year contracts were almost entirely c.i.f., there has this year been made almost nothing but f.o.b. contracts.

The prices for delivery during the season of 1912 have been as follows:

For half clean spruce logs from 45s. to 52s. per English cord, f.o.b. St Petersburg.

For all clean spruce logs from 49s. to 56s. per English cord, f.o.b. St. Petersburg.

The considerable rise in the price is partly caused by the steadily increasing demand from foreign countries, but also the nearly snowless winter and the want of water in the rivers for floating, as well as the steadily increasing wages, have had some influence on the price.

Two or three different parties are said to be considering putting up pulp and paper mills at Kenora, Ont. Power from the Keewatin would be used, although it is stated that prices asked by the Keewatin Power Co. for its water power are



### Pulp and Paper News

The Beaver Board Co.'s large new factory, near Aylmer, Que., is nearly completed.

\* \* \*

E. B. Berwick, Sulphite Superintendent of the Anglo-Newfoundland Paper and Pulp Co., has retired to Sherbrooke, Que., near which place he has bought a farm.

\* \* \*

The Union Bag and Paper Company's pulp mill, near Quebec, which was only built last summer, is now turning out about 100 tons of ground wood daily.

\* \* \*

A syndicate has bought the site of the old Tait and Meating Granite Co.'s property at St. George, N.B., and will, it is said, erect a paper bag factory thereon.

\* \* \*

The Chicoutimi Pulp and Paper Co. has obtained a contract to supply the Harmsworth paper mill, near London, with 25,000 tons mechanical pulp each year for ten years.

\* \* \*

We are informed just as we go to press that the Dryden Timber & Pulp Co.'s plant at Dryden, Ont., has been destroyed by fire, entailing a loss of \$350,000 on the contractors in Montreal. The company was just about to begin operations.

\* \* \*

The Wayagamack Pulp and Paper Co., Three Rivers, which has been manufacturing kraft at the rate of 50 tons daily, has now begun shipments. James Reid Wilson has been elected director of the company in succession to Sir R. Forget.

\* \* \*

The Donnacona Paper Co. have begun construction work on their new mill on the Jacques Cartier River, in Quebec Province, the contractors being the Ambursen Hydraulic Co. A dam 1,200 feet long and 40 feet high will be erected. The newsprint mill is to be completed next year.

\* \* \*

The Laurentide Pulp and Paper Co. is calling for tenders for a large extension of its Grand Mere plant. Among the new

developments will be a new power dam, making an additional 25,000 h.p. available. A new pulp digester is already under construction, which will have an output of 30 tons daily.

\* \* \*

The F. N. Burt Co., manufacturers of paper boxes, Toronto and Buffalo, will increase their capital by \$500,000 worth of new preferred stock. This, together with \$45,000 unissued preferred stock in the treasury, is being offered to shareholders at par in the proportion of one new share of preferred to every four of either preferred or common.

\* \* \*

The Smart Bag Company, Montreal, and Woods, Ltd., Hull, Que., have been merged under the name of the Smart-Woods Co., with a capitalization of \$5,000,000. They have factories for the manufacture of paper and other bags at Toronto, Montreal, Winnipeg and Hull. Col. C. A. Smart, Montreal, will be managing director, and Col. J. W. Woods, of Ottawa, vice-president.

\* \* \*

The Sherbrooke Machinery Company, Ltd., Sherbrooke, Que., have just completed arrangements with the Wilbraham-Green Blower Company, of Pottstown, Pa., whereby they are to manufacture the various lines of blowers and vacuum pumps, under the Wilbraham-Green Blower Company's patents. The smaller size vacuum pumps are meeting with favor in the various pulp mills.

\* \* \*

The Natural Resources Department of the Canadian Pacific Railway will enter on a policy of reforestation of the waste lands along its lines in New Brunswick and Nova Scotia. The company announces that, if not held up by high prices, it will buy any waste lands along these lines that are not suitable for farming, put the best foresters in the country in charge of them, and start raising trees, the idea being to specialize in trees suitable for railroad ties and pulp wood.



Prof. E. J. Zavitz of the Ontario Agricultural College, Guelph, has been appointed by the Ontario Government Forestry Commissioner of the Province, his duties being to advise the Department of Lands, Forests and Mines in regard to all matters connected with the cutting of forests. No lumbering operations will be allowed without his recommendation, and he will see to the destruction of all debris and slash and will deal with reforestation and conservation in general.

\* \* \*

The Lake Superior Corporation, Sault Ste Marie, Ont., held its annual meeting at Camden, N.J., last month, and reported a very satisfactory year, ending with Jan. 30th. Total earnings, including paper, power and steel, amounted to \$1,579,000, an increase of about 30 per cent. This will be greatly increased on completion of the new paper mills. Price Bros.' new mill at Jonquiere, Que., is now about completed, at least the section of two newsprint machines with a capacity of 50 tons daily each. Another machine is expected to be in operation next year.

\* \* \*

The Powell River Company, Ltd., Powell River, B.C., have just placed an order with the Sherbrooke Machinery Company, Ltd., Sherbrooke, Que., for ten (10) ground wood thickeners, of their latest patented design, the same being of their massive cast iron and sheet steel construction. The above being the same general design and construction as the thickeners which the Sherbrooke Machinery Co., Ltd., supplied the Anglo-Newfoundland Development Co., and the Lake Superior Paper Company, which are all covered by patents in Canada and all foreign paper-making countries.

\* \* \*

Mr. Archibald M. Huestis, formerly manager of the Canada Coating Mills, Ltd., Georgetown, has re-entered the paper field as a paper mills' representative, with offices, temporarily, at 103 Mail Building, Toronto. He will pay particular attention to specialties of one kind or another, but we are not in a position at the present time to write in detail, as plans and ar-

rangements are only now being perfected. Mr. Huestis is not only so well-known, but so well-liked by the trade in all parts of the Dominion, and to a large extent in the United States, that it is a safe prophesy to forecast that his new departure will be crowned with a very large measure of success.

\* \* \*

Our readers will be interested to know that Mr. Alexander Annandale, the Scottish paper-maker, who has written several valuable articles for the Pulp and Paper Magazine, has now come to Canada with a view to settling down in the paper trade of this country. He is looking for an opening in accordance with the advertisement in another column. Mr. Annandale is thoroughly experienced in the practical and economical manufacture of paper, as is shown by the highly appreciative testimonials which we have seen. He has also a knowledge of chemistry and engineering, and is experienced in the buying of raw material, as well as in selling the finished product. He may be looked upon as an all-round paper man. Mr. Annandale is accompanied by his son, who has been through practically all departments of a paper mill.

\* \* \*

The John McDougall Caledonian Iron Works Company, Limited, of Montreal, have been appointed exclusive agents for Canada for the high speed steam engines built by Browett, Lindley & Co., Limited, of Manchester, England. The "Browett-Lindley" enclosed, forced lubrication, double-acting engines are simple in construction, and, owing to the efficient system of lubrication and perfect balance of the moving parts, run silently and steadily under all conditions of load. The company has made a specialty of building engines for driving dynamos since the earliest days of the electrical industry. The "Browett-Lindley" is in use in the largest electric light and tramway stations, as well as in the most important collieries, steel and iron works, cotton and paper mills, etc., in England, and has earned an enviable reputation for economy and high efficiency.

## Montreal Pulp and Paper Matters.

(Special Correspondence)

Montreal, Nov. 30.

Among the news manufacturers, there is a certain amount of apprehension over the opening up of so many new mills. It is felt that the new mills will produce more than the markets here can absorb, and unless paper is exported to Europe there may be a slight recession in prices. However, as the European market seems to be in good shape at the present time, it is altogether likely that paper will be exported there. One prominent paper man in speaking about the opening up of new mills said:

"There are plenty of mills at the present time to take care of the full demand for the next two years at least. It would be great folly on the part of brokers or financial men to build new mills for at least another two or three years. Were they to do so it would demoralize the industry and might seriously affect the financial standing of existing mills. If producers and others would wait for about three years, until consumption overtook production, there would be some excuse for the establishment of new mills. At present there is no need of additional mills. Oftentimes brokers look at a prosperous industry simply as a means of floating other companies on the showing made by existing companies. They get profits from the sale of the bonds and stocks, and do not care a bit what happens to the existing plants or to the new one they have launched. There is just a danger that this will be done in connection with the pulp and paper industry."

### New Pulp Output.

The Abitibi Pulp Company, financed by Messrs. F. H. Anson and Shirley Ogilvie of Montreal, have decided to confine their operations to ground wood only. At one time it was stated that they intended to manufacture news, but they have decided not to manufacture anything but ground wood. The Bronsons of Ottawa are the latest to enter the ground wood field,

this firm having started three grinders going about the middle of the month. The production is about 20 tons daily. It is also stated here that the Spanish River Pulp and Paper Company are installing two more machines.

### Anticosti Island.

Henry Menier, the Paris Chocolate manufacturer and owner of the Island of Anticosti, is developing a great pulp industry on the Island. Previously the energies of the people were devoted to fishing and farming in a kind of haphazard way. A year ago Menier decided to commence the exportation of pulp wood. He found the business a profitable one, and this year has had four steamers carrying pulp wood to points along the Great Lakes as far west as Niagara Falls and as far east as Portland on the Atlantic coast. Next year he hopes to have three additional vessels engaged in the trade. His exports of pulp wood, coming as they do, from privately owned lands, means much to American paper manufacturers, some of whom believe that the Island of Anticosti will be able to supply their needs for many years to come.

The Spanish River Pulp & Paper Mills will probably have the two additional paper machines ordered recently in operation by the beginning of February, when the paper output of the company will run about 200 tons a day. It is stated that the company has contracts signed for the sale of its entire output, including that of the new machines, for the next five years. It is also understood that the Ontario Pulp & Paper Company has nearly as long a contract signed for its output of 100 tons of manilla. In addition to their paper production both the Spanish River and Ontario companies will have a certain surplus of pulp, mechanical and sulphite from the Ontario plant, to dispose of.

## Pulp and Paper Markets

### TORONTO PULP AND PAPER MARKETS.

Toronto, Nov. 30, 1912.

In the paper trade very little in the way of new developments has transpired since last report. The newsprint mills have not been quite so pressed, but it must be remembered that during the last few months large additional capacities have come into operation and all the new output has been absorbed without making any material impression on the market.

There is very little change in other kinds of paper.

Ground wood has been very quiet owing to a cessation of shipments to the U. S., except on old contracts. Good water conditions both in Canada and the U. S. have resulted in large quantities being piled and prices are easy. In England, Canadian pulp would have to compete with Scandinavian, and at present prices the latter has the advantage.

Sulphite continues as strong as ever.

---

Montreal, Nov. 30, 1912.

The pulp and paper market remains in about the same condition as it was in a year ago. All the mills are busy, and generally speaking there is a confident and optimistic tone among the manufacturers, prices remaining firm despite the light tendency towards lower levels which are found in the United States. Groundwood in this country is looking up a degree owing to the approach of winter and the lessened production. The sulphite mills are extremely busy, and those which are producing book pulp are finding prices at the very top point in their history. Bleached sulphite is extremely hard to get, and shows a tendency towards higher prices. All sulphite market looks to be in a strong position for 1913 and probably for 1914 as well.

Quotations for paper, pulp and paper stock are as follows:

News, \$45.00, delivered in United States.

News, \$42.00, delivered in Canada.

News print, rolled, \$2.00.

News print, sheets, \$2.25.

Book papers, carload lots, No. 3, 4¼ to 5c.

Book papers—Broken lots No. 3, 4½ to 4¾ cents.

Carload lots No. 2, 4¾c.

Manila B, 3½c.

Broken lots No. 2, 5½ to 5¾c.

Carload lots No. 1, 5½ to 6¼c.

Broken lots No. 1, 6 to 6¾c.

Wrappings—

Manila B, 3½ to 3¾ cents.

Fibre, 3¾ to 4c.

No. 2 Manila, 3½c.

No. 1 Manila, 3¾ to 4¼ cents.

Kraft, 4 to 4¾ cents.

Pulp—

Ground wood, at mill, \$15.50 to \$16.50.

Sulphite, \$46.50 to \$47.50, delivered in United States.

Sulphite, \$44.50 to \$45.50, delivered in in Canada.

Sulphite (bleached), \$52 to \$54.

Sulphite (unbleached), \$45 to \$46.

### BRITISH MARKETS.

According to World's Paper Trade Review, manufacturers seem to be fairly confident of maintaining their prices for mechanical wood pulps. There is more enquiry, but little business is apparently passing just now. The outlook favors pulpmaker and counter offers do not meet with acceptance.

The market for sulphite and soda pulp keeps very firm. As makers are now practically sold out for next year, and as consumers in this country are covered, there is little movement consequently in the market. One can only note the continued demand from the United States. There are some enquiries for delivery over 1914-15, but buyers do not seem able to face the prices

Continued on Page xxviii.

**EMERSON MANUFACTURING CO.**  
**LAWRENCE, MASS.**

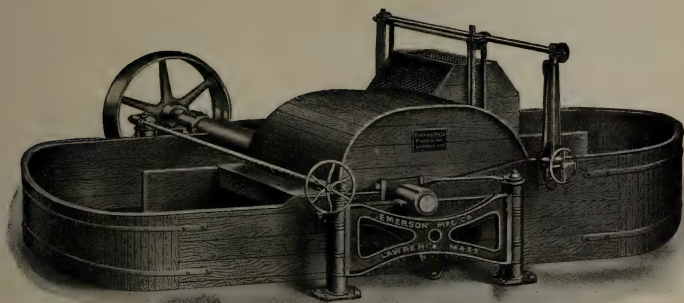

**Beating and Washing Engines**  
**Paper Mill Machinery**

**THE UNITED WIRE WORKS LTD,**  
**EDINBURGH, GLASGOW & NEWCASTLE-ON-TYNE**  
**FOURDRINIER WIRES, CYLINDER WIRES,**  
**AND WIRE CLOTH OF ALL KINDS.**

AGENTS, ARTHUR P. TIPPET & CO 8 PLACE ROYALE MONTREAL.  
WIRES HELD IN STOCK AT MONTREAL FOR PROMPT DELIVERY.

**ARTHUR P. TIPPET & CO.**

AGENTS AND IMPORTERS  
**PAPER MILL SUPPLIES**  
**SULPHUR, FELTS**

SAL AMMONIAC, BORAX, SATINITE, ETC.  
MONTREAL, TORONTO.

IMPROVED WARREN PATENT

# Double Drum Winder

With Slitter Attachment Combined

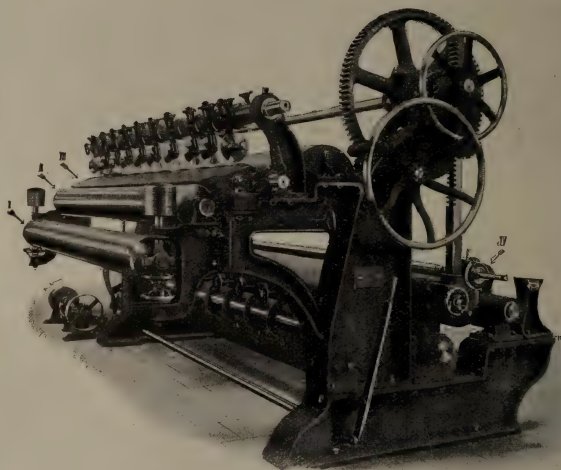

REAR VIEW SHOWING SLITTERS,

REFERENCE :

- I—8-inch Brass Spring Roll.
- II—8-inch Brass Carry Roll.
- III—8-inch Adjustable Draw Board.
- IV—Adjustable Core Shaft Box.

Compare this Winder with Others

BUILT BY

## Ticonderoga Machine Works

TICONDEROGA, N.Y., U.S.A.



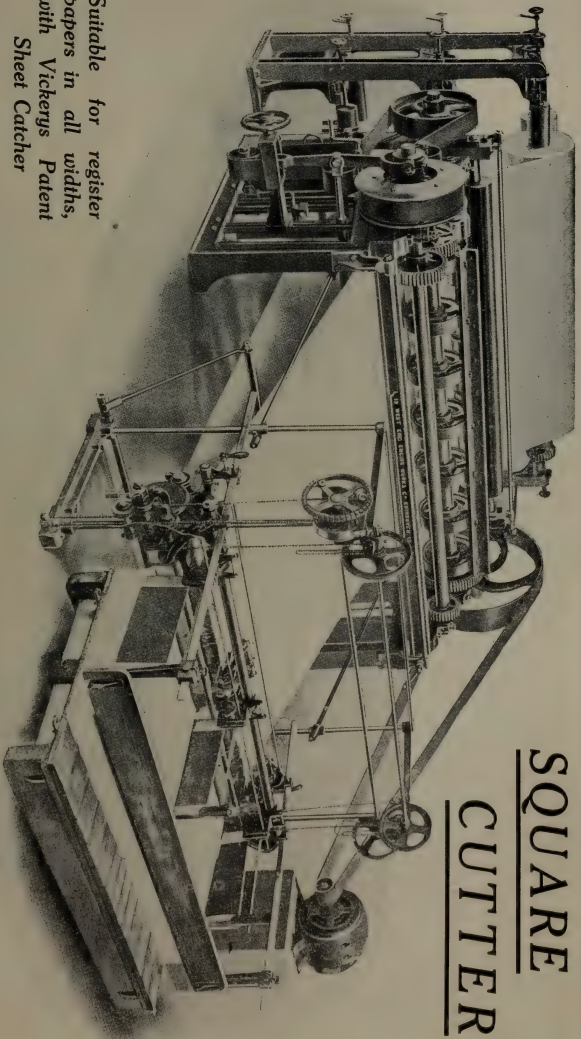

# SQUARE CUTTER

Suitable for register  
papers in all widths,  
with Vickerys Patent  
Sheet Catcher

MADE BY

**THE WEST END ENGINE WORKS CO.**  
PAPER MAKERS' ENGINEERS

EDINBURGH  
SCOTLAND

which makers seem to think it necessary to ask for that period. In deed, there is a disposition on the market not to accept lower prices.

For chemicals, the home market notes a very fair business with good prices. Bleaching powder is in good request. So is ammonia alkali, while caustic soda shows no change.

#### SCANDINAVIAN MARKETS.

"Mercator" reports the markets as follows:

The mills working with water power appear everywhere to have plenty of water, but the consumption appears to be very good everywhere, and prices keep firm. It even seems probable that the present prices are not top ones yet, but that the near future will show a further advance. One reason for this is that the German pulp mills will apparently be shortly forced to increase their prices, the prices for the raw material having lately risen a good deal. The same circumstance is also making itself felt in Canada. In mechanical pulp a firmer tone is noticeable. The prices are, nevertheless, unchanged. From Sweden there have lately been sold rather large quantities at about 35 kr. for wet and 75 to 80 kr. for dry pulp. In chemical pulp the position is, as before, eminently satisfactory. From Norway a few large sales are reported at 170 kr. for easy bleaching and 160 kr. for strong sulphite, c.i.f. English port.

#### NEW INCORPORATIONS.

Hale & Company, Ltd., Vancouver, capital \$100,000. To manufacture and deal in lumber, pulp and paper, etc.

\* \* \*

Canadian Leatherboard Company, Ltd., Chambly, Que., capital \$50,000. To make

and deal in leatherboard, fibreboard, etc. H. N. Chauvin, A. H. Duff, W. Stewart, Montreal.

\* \* \*

Berlin Fibre Products Co., Ltd., Berlin, Ont., capital \$40,000. To manufacture goods from sulphite fibre. J. W. & D. Hibner, W. H. Schmalz, J. Killer, C. Kranz and H. Q. Janzen, all of Berlin, Ont.

\* \* \*

Smart Wood Company, Montreal, capital \$5,000,000. To manufacture paper and other kinds of bags. C. A. Smart, Westmount, Que.; C. E. Archibald and F. H. Wilson, Montreal; J. W. Woods, Ottawa.

\* \* \*

Russell Timber Co., Ltd., Port Arthur, Ont., capital \$50,000. To cut and sell timber, manufacture and sell pulp wood and all by-products of lumber. W. H. Russell, T. A. Read, W. F. Langworthy, all of Port Arthur.

\* \* \*

Noble Scott, Toronto, capital \$40,000. To take over the business of Scott Printers' Ltd., and carry on business as printers, publishers, stationers, etc. G. G. Plaxton, M. P. Scott and W. H. Coltier, C.E., all of Toronto.

\* \* \*

Fibre Products, Ltd., Thorold, Ont., capital \$250,000. To manufacture wood and chemical pulp and all articles made wholly or partially of pulp; also paper. F. W. and G. J. Manson, of St. Catharines, Ont., and W. H. Barrows and R. Storar of Thorold.

\* \* \*

Anglo-Canadian Timber Co. of British Columbia, Ltd., London, Eng. Licensed to do business in British Columbia. Capital \$250,000. To acquire timber and pulp lands, etc.; do business as saw mill owners, pulp and paper manufacturers, etc. Charles Stirling, Vancouver.

## The PULP & PAPER TRADING CO.

TEMPLE COURT BUILDING, NEW YORK CITY.  
DEALERS IN

# Paper and Pulp of All Kinds.

Prices and Samples on Application.

Telephone: 2726 BROAD.

Cable Address: "LAGERLÖF NEWYORK."

# Scandinavian-American Trading Company,

PRODUCE EXCHANGE BUILDING, NEW YORK,

IMPORTERS AND EXPORTERS OF

FOREIGN AND DOMESTIC

# WOOD PULP

OF ALL KINDS

AND

# PAPER MILL SUPPLIES.

HANS LAGERLÖF, PRES.

# The Ashcroft Paper Tester

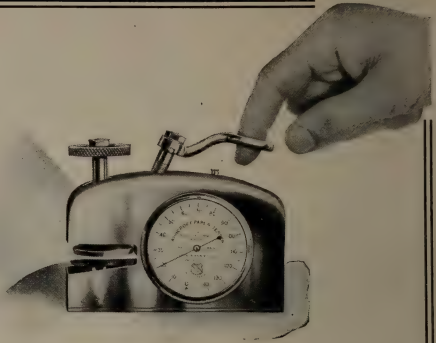

Price \$25.00.

Calf Skin Case, \$1.25 extra.

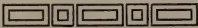

Is constructed entirely of metal, is not affected by changes in temperature, is not affected by incessant use, and will not get out of order. Made in 20 lbs. capacity for testing the strength of tissue. News, Book and other weak papers, and in 140 lbs. capacity for testing the strength of anything in the way of paper commonly used. Either or both on 10 days trial.

ASHCROFT MANUFACTURING CO.

85 Liberty Street

New York

*Sales Agent for Eastern Canada:*

**G. B. Legge, 156 Yonge St., Toronto**

# CLASSIFIED ADVERTISERS' INDEX

If you fail to find what you want in these columns, write us and the desired information will be gladly supplied

## Architects and Engineers

Ambursen Hydraulic Con. Co.  
T. Linsey Crossley  
J. A. DeCew  
Eaton & Brownell  
Geo. F. Hardy  
Herbert S. Kimball  
International Process Co.  
Arthur D. Little, Inc.  
R. S. Lea & H. S. Ferguson  
Lyford, Clark & Lyford  
H. B. Prather  
Chas. B. Pride  
T. Pringle & Son  
Stebbins Eng. & Mfg. Co.  
R. O. and W. G. Sweezy  
Jos. H. Wallace & Co.

## Barkers.

Carthage Machine Co.  
Green Bay Barker Co.  
Jenckes Mach. Co.  
Waterous Engine Works.

## Beaters.

Dillon Mach. Co.  
Emerson Mfg. Co.  
Holyoke Mach. Co.  
E. D. Jones & Sons Co.  
Valley Iron Works  
Waterous Engine Works

## Beater Rolls.

J. A. DeCew  
J. Marx & Co.

## Belting.

Dom. Belting Co.  
F. Reddaway & Co.  
Sadler & Haworth

## Bleaching Powders.

Brunner, Mond & Co.  
Hooker Electro-Chemical Co.  
Winn & Holland

## Boilers.

Jenckes Machine Co.  
John McDougall Caledonian Iron Works

## Brass Wire Cloth, Fourdrinier Wires.

Geo. Christie, Ltd.  
Herman Finckh  
C. H. Johnson & Sons, Ltd.  
Jas. Taylor  
A. P. Tippet & Co.  
United Wire Works  
P. P. Westbye

## Camel Hair Belting.

F. Reddaway & Co.

## Calendar Rolls.

Farrel Foundry & Mach. Co.

## Chemicals, Colors, Etc.

Brunner, Mond & Co.  
Gewerkschaft Sachtleben  
A. Klipstein & Co.  
Hooker Electrochemical Co.  
Paper Makers' Chemical Co.  
A. P. Tippet & Co.  
United Alkali Co.  
Wilson-Paterson Co.  
Winn & Holland

## China Clay.

China Clay Co.  
A. Klipstein & Co.  
C. A. Meincke & Co.  
Paper Makers' Chem. Co.  
Wilson-Paterson Co.

## Chippers.

Carthage Machine Co.  
Jenckes Machine Co.

## Conveying Machinery.

H. W. Caldwell & Son Co.  
M. Garland Co.  
Jeffrey Mfg. Co.

## Digester Lining.

Panzl Digester Lining Co.  
Preston's Digester Lining Co.  
Stebbins Eng. & Mfg. Co.

## Digesters.

Swenson Evaporator Co.  
**Digester Gauges.**  
Schaeffer & Budenberg

## Drainer Bottoms.

Samuel Snell Co.

## Evaporators.

Ernest Scott & Co.  
Swenson Evaporator Co.  
Zaremba Company.

## Exporters.

Parsons Trading Co.

## Felts.

F. Bredt & Co.  
Dallyn, Jardine & Co.  
Hamelin & Ayers Co.  
C. H. Johnson & Sons, Ltd.  
Penman's, Ltd.  
Joseph Porritt & Sons.  
J. H. Spencer & Sons.  
A. P. Tippet & Co.

## Fourdriniers Wires.

(See Brass Wire Cloth.)

## Gauges.

Ashcroft Mfg. Co.  
Schaeffer & Budenberg

## Grinders.

Carthage Machine Co.  
Glens Falls Mach. Co.  
Wm. Hamilton Co.  
Holyoke Machine Co.

Jenckes Machine Co.  
J. M. Voith  
Waterous Engine Works

## Knives.

Crookes, Roberts & Co.  
Peter Hay Knife Co.  
A. P. Tippet & Co.

## Lamps.

Gustaf Fornstedt.

## Paper Mills.

Canada Coating Mills.  
Canada Paper Co.  
New Brunswick P. & P. Co.  
Rolland Paper Co.  
Riordon Paper Co.

## Paper Presses.

Can. Boomer & Boschert Press Co.  
Jenckes Machine Co.

## Paper and Pulp Dealers.

Atterbury Bros.  
Albert E. Mallandain.  
Castle, Gottheil & Overton  
Churchill & Sim  
Howell Co.  
Parsons Trading Co.  
Pulp and Paper Trading Co.

## Paper Stock, Bags, Etc.

Atterbury Bros., Inc.  
J. Christie Co.  
R. Hough  
The Howell Co.  
E. Pullan  
J. R. Walker & Co.

## Paper and Pulp Mill Machinery.

Appleton Machine Co.  
Beloit Iron Works  
Bentley & Jackson  
James Bertram & Son, Ltd.  
Bertram's, Limited  
The Black-Clawson Co.  
Canadian Boving Co.  
Carthage Machine Co.  
Chambers & Simpson  
Dillon Machine Co.  
Emerson Mfg. Co.  
Farrel Foundry & Machinery Co.  
Julius Fischer  
Glens Falls Machine Wks.  
Green Bay Barker Co.  
Wm. Hamilton Co.  
Harmon Machine Co.  
J. H. Horne & Sons Co.  
Holyoke Machine Co.  
Jenckes Machine Co.  
E. D. Jones & Sons Co.  
C. H. Johnson & Sons, Ltd.  
Marx, J. & Co.  
Jas. Milne & Sons  
Moore & White Co.  
B. F. Perkins & Son



Rice, Barton & Fales  
Ryther & Pringle  
Sandy Hill Iron & Brass  
Works  
Ernest Scott & Co.  
Sheldons, Ltd.  
Sherbrooke Machinery  
Co., Ltd.  
S. Morgan Smith Co.  
Stebbins Engineering &  
Mfg. Co.  
H. F. Storrer  
Swenson Evaporator Co.  
Ticonderoga Machine  
Works  
Valley Iron Works  
J. M. Voith  
Charles Walmsley & Co.  
Chr. Wandel  
Wandel Screen Mfg. Co.  
Waterous Engine Works  
Co., Ltd.  
P. P. Westbye  
West End Engine Wks. Co  
Zaremba Co.

**Paper Machine Tachometers.**  
Schaeffer & Budenberg.

**Paper Tester.**  
Ashcroft Mfg. Co.

**Pipes (Wooden).**  
National Pipe & Foundry  
Co., Ltd.

**Pulp Stones.**  
Stancliffe Estates Co.  
Ltd.

**Pumps.**  
Can. Boving Co.  
Carthage Machine Co.  
Dillon Machine Co.  
Lawrence Machine Co.

Lawrence Pump & En-  
gine Co.  
John McDougall Caledon-  
ian Iron Works.  
Smart-Turner Mach. Co.

**Recording Gauges.**  
Schaeffer & Budenberg.

**Recording Thermometers.**  
Schaeffer & Budenberg.

**Rosin Size.**  
Paper Makers Chemical  
Co.  
Vera Chemical Co.  
Wilson-Paterson Co.

**Scales.**  
Alfred H. Mardon

**Screen Plates.**  
Union Screen Plate Co. of  
Canada

**Screens.**  
Glen Falls Machine Wks.  
Harmon Machine Co.  
Jenckes Machine Co.  
Sherbrooke Machinery Co.  
J. M. Voith.  
Chr. Wandel  
Wandel Screen Mfg. Co.  
Waterous Engine Works  
P. P. Westbye

**Slitters and Re-Winders.**  
Moore & White Co.  
Ticonderoga Mach. Co.

**Sulphur.**  
Union Sulphur Co.

**Tachometers (Hand and  
Stationary).**  
Schaeffer & Budenberg.

**Talc.**  
Geo. H. Gillespie Co.

**Tanks.**  
Jenckes Machine Co.  
John McDougall Caledon-  
ian Iron Works

**Thermometers.**  
Schaeffer & Budenberg.

**Transmission Machinery.**  
H. W. Caldwell & Son Co.  
Jones & Glasco  
Dodge Manufacturing Co.

**Travelling Cranes.**  
Hugh R. Blethen  
Northern Crane Co.  
Smart-Turner Mach. Co.

**Turbines.**  
J. M. Voith  
S. Morgan Smith Co.

**Water Wheels.**  
Jenckes Machine Co.  
John McDougall Caledon-  
ian Iron Works  
Wm. Hamilton Co.  
Holyoke Machine Co.

**Wire Cloth for Paper Ma-  
chines.**  
Scottish Wire Cloth Co.,  
Ltd.

**Wood Pulp Agents.**  
Castle, Gottheil & Over-  
ton  
Churchill & Sim  
Parsons Trading Co.  
Scandinavian Amer. Trad-  
ing Co.

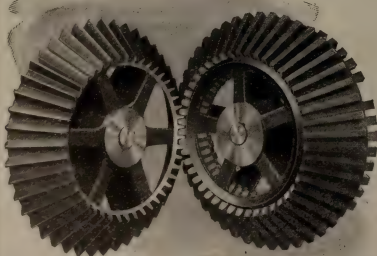

## Mortise Wheels, Spur, Bevel and Miter

Castings of semi-steel by our improved method of machine molding, thus insuring uniform tooth spacing, true rims and smooth running with high efficiency.

Teeth of both mortise wheel and pinion finished by accurate gear cutting machinery. Designers and builders of water wheel harness.

Send for Catalogue No. 34

---



---

# H. W. CALDWELL & SON CO.

50 Church Street  
NEW YORK

17th St. and Western Ave.  
CHICAGO

# Samson Water Wheels

are specially suited for driving pulp mill machinery. They are durable, steady running and easy to operate, and are well adapted to direct connection to grinders.

— WE ALSO BUILD —

**Log Haul-Ups and Slashers,  
Grinders, Stuff Pumps, Etc.**

You have only to write for catalogues, prices or any other information you require.

**William Hamilton Company**  
PETERBOROUGH, ONT.



# J. H. Horne & Sons

COMPANY

Lawrence

Mass.

— MANUFACTURERS OF —

## PAPER MILL MACHINERY

Fourdrinier,  
Cylinder, and  
Wet Machines.

Improved Horne Engines.

Horne Jordan Engines.

Double Bevelled Roll Bars.

Cone Pulley Cutters.

Horne Friction Cutters.

Barbed Jordan Bars.

“NEW PROCESS” CHIPPER KNIVES.

## PERKINS BLEACH EJECTORS

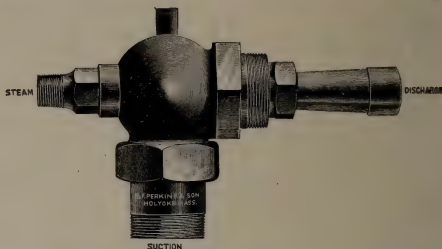

will pump your Bleach at practically no cost, first or last. Made in different sizes to meet all requirements. Write for special circular with list of references

**B. F. PERKINS & SON, Inc. - Holyoke, Mass.**

## FROZEN PULP AND DRY PULP IN A

# Ryther Shredder

Is shredded at the rate of 5 tons per hour. 17 to 25 H. P. required. The above figures are *dry weight* and absolutely guaranteed.

RELIEVE YOUR BEATERS and INCREASE QUALITY and PRODUCTION. Write for full Particulars.

---

**Ryther & Pringle Company**  
Carthage, N.Y.

# Centrifugal Pumps

SPECIALLY DESIGNED FOR

## HANDLING PULP

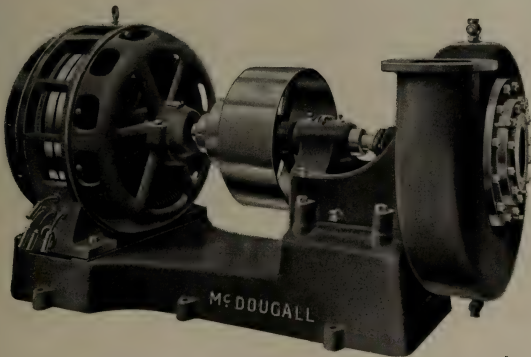

CENTRIFUGAL PUMP ARRANGED FOR  
EITHER BELT OR MOTOR DRIVE

*See Bulletin 106*

**THE JOHN McDOUGALL  
Caledonian Iron Works Co.**

LIMITED

WORKS, WILLIAM AND SEIGNEURS STS. - MONTREAL

**PRESTON'S**

# Lining for Sulphite Digesters

TOTAL THICKNESS ONLY  $2\frac{1}{2}$  TO  $2\frac{3}{4}$  INCHES

Resists the action of the acid and ensures absolute protection to the Digester Plates.

Great durability, therefore large saving in upkeep and repairs.

Larger internal space and increased production on account of the small thickness occupied.

Extensively adopted by Scandinavian and Continental Mills.

Over 200 Digester Linings in work and on order.

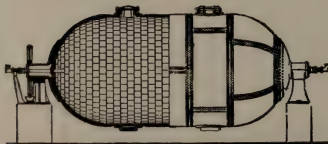
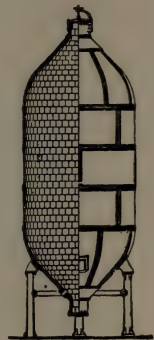

Telegraphic Address :

**"PRESTONS, RADCLIFFE."**

CODE USED A. B. C., 4TH & 5TH EDITION.

*Full Particulars and Prices on application to SOLE MANUFACTURERS*

## PRESTON'S DIGESTER LINING CO., LIMITED

RADCLIFFE, near Manchester, Eng.



---

---

FARREL FOUNDRY AND MACHINE  
COMPANY

ANSONIA, CONN., - - U. S. A.

Largest Manufacturers in the world of

**CHILLED ROLLS**

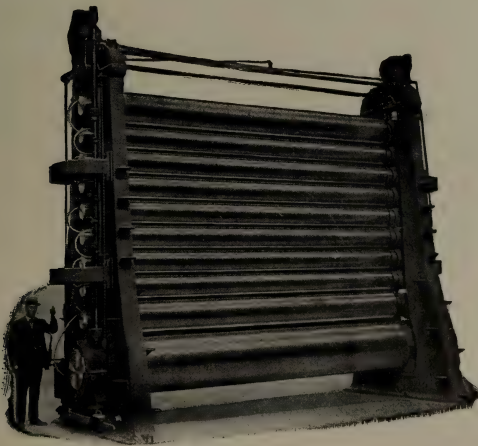

**CALENDERS**

*WITH PATENT HYDRAULIC LIFT*

**ROLL GRINDING MACHINES**

---

---

Would YOU like to enlarge your Business and find new Customers in all parts of the world? If so, ADVERTISE in

# “THE PAPER-MAKER AND BRITISH PAPER TRADE JOURNAL.”

THE LEADING AND MOST POPULAR TRADE ORGAN.

**THE ADVERTISER IS GOOD FOR THE READER**

We recently received the following letter:—

“We have hesitated over the matter, as we are at present so busy as to regard further advertising as almost superfluous.

“On the whole, however, we find it pays us better to have to refuse orders than to hunt after them, and will ask you therefore to insert our advertisement on same terms as last.

“We enclose herewith amended matter for advertisement, and shall be glad to have proof of same at your early convenience.”

We are constantly in the receipt of gratifying letters relative to the usefulness of our Journal, and we have pleasure in printing the following:

“Gentlemen,

We beg to advise that we have not as yet received the June number of ‘THE PAPER-MAKER AND BRITISH PAPER TRADE JOURNAL.’

We like the publication so well that we should be very sorry indeed to miss a copy of it.

Thanking you in advance for your kind attention,

We are, dear Sirs, yours very truly,  
F. R. KEYES & SON.  
20 Broad Street, New York.”

**S. C. PHILLIPS & Co.’s STANDARD PUBLICATIONS**

## The Paper-Maker

AND BRITISH PAPER TRADE JOURNAL.

Published on the 1st of each month. Price 1s., by post 1s. 6d. Annual Subscription 12s. 6d. post free.

## The Stationery World, Printing and Allied Trades,

AND FANCY GOODS REVIEW.

Published on the 25th of each month. Price 6d. by post 7½d. Annual Subscription 5s. post free.

Chief Offices:

## The Paper Box and Bag Maker.

Published on the 19th of each month. Price 6d., by post 7½d. Annual Subscription 6s. 6d. post free.

## Phillips' Paper Trade Directory of the World

15s. 6d., post free to all countries.

NEW EDITION FOR 1911 NOW READY.

Specimen Copies and Advertisement Rates  
FREE OF APPLICATION.

47 CANNON STREET, LONDON, E.C. (ENGLAND).

# PAPER and CLOTH Specialties

*For Rent and Club Cards, Pattern Cards, Map Printing, Label Printing, Envelopes, etc., etc.*

Cloth Lined Papers. Cloth Centred Papers and Boards. Cloth Lined, Chromo and Enamel. Cloth Lined Boards and Cards (surfaced and enamelled). Cloth Centred Boards (surfaced and enamelled). Manilla Surfaced Boards and Cards.

**Also Enamelled Blotting. Art Papers. Paste Boards. Chromo and Surface Papers**

Customers' requirements in specialties are carefully considered and experiments conducted if necessary.

---

**ALBERT E. MALLANDAIN**

OFFICES: 51 Cheapside  
London, E.C.

MANUFACTURER

MILLS: Park Royal  
Willesden, London, N.W

**E. H. WILKINSON**

Telephone Building  
82 Adelaide Street West  
Toronto

*Sole Agent for Canada*

Telephone Main 1716  
Cable Address: *Faultless*

---

# HERMANN FINCKH

REUTLINGEN

*Established 1879*

GERMANY

---

# FOURDRINIER WIRES

---

## SULPHITE - MACHINE WIRES

## CYLINDER WIRES

---

**P. P. WESTBYE, - Peterborough, Ontario**

*Sole Agent for Canada*

## WANT AND FOR SALE ADVERTISEMENTS

**MECHANICAL** and mill engineer open for engagement. Sulphite fibre pulp and paper mill constructions and rebuilding. All references. Apply Box 40, Pulp and Paper Magazine.

**ENGINEER**—With head office in St. John, N.B., would like to correspond with responsible firm of pulp and paper machinery manufacturers wishing to open business in the Maritime Provinces. Apply "Reliable," c/o Pulp and Paper Magazine.

**EXPERT MANAGER** of the German Amalgamated News Paper Mills wants similar position in Canada or United States. Familiar with the news markets of Asia, Australia, South America; speaks German, French, English, Spanish, Portuguese. Kindly correspond with Erich Dickudt, W. 57 Zietenstrasse 16, Berlin, Germany.

**UNDER MANAGER**.—Young man, 14 years' practical experience in English mill making long elephants, news, all-wood printings, cream laid, etc. Experienced mill chemist—testing of papers, fibres, etc. Highest references. Address H. C., c/o Pulp and Paper Magazine.

**SWEDISH** gentleman at present in America with wide experience in Europe and this country in sulphite, pulp and paper industries, desires position as designer of or superintendent for such mill. Consumption of sulphur in last mill built, 8 per cent. Brown, steamed wood pulp and paper a specialty. Also consultations. Good references. Correspondence solicited. C. E. B., c/o Pulp and Paper Magazine.

**MASTER MECHANIC** wants change; twenty years' experience in Canadian and American pulp and paper mills; good workman and experienced foreman. Best references. Address Box 39, Pulp and Paper Magazine.

**ENGINEER**—English, 38, with exceptional experience in the paper trade, is open for an appointment. Fully qualified, civil and mechanical training and practice. 22 years with two (only) of the largest paper makers in the country. Well up on fuel, engines, boilers, and electrical plant, and driving. Conversant with the latest paper mill methods and machinery. Can design, build, and operate a works for any output. Had very extensive experience in building and railway work, bridges, and reinforced concrete. Good organizer and disciplinarian. Apply Box 35, Pulp and Paper Magazine.

**PRACTICAL PAPERMAKER** with experience in all departments, and also of management and selling, desires engagement. Highest references. Address Alex. Annandale, c.o. Paper and Pulp Magazine of Canada, Toronto.

### FOR SALE

As we are using all our Water Power at our Pulp Mill for electricity, we are disposing of the Pulp Mill Machinery—including Millard Patent Grinders which were in use only a few months and are absolutely as good as new, also Wet Machines, Barkers, Screens, Pumps, Piping, Shafting, Stones, etc., etc., all in good condition. Full information will be given upon application.

Apply Box "A,"

Pulp and Paper Magazine

**FOR SALE**.—Special Second-hand cylinder mould, 48-in., diameter 84-in. face. Good as new. Can be used as Filter. For particulars, etc., address Box 32, Pulp and Paper Magazine.

**THE PAPERMAKERS' POCKET BOOK**—By James Beveridge—Specially compiled for Paper Mill Operatives, Engineers, Chemists and Officials. Price \$3.50. Biggar-Wilson, Ltd., Toronto.

SCOTT'S IMPROVED RECOVERY SYSTEMS  
FOR  
**SODA, SULPHATE & SULPHITE**

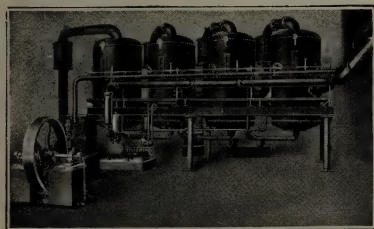

Spent Liquors give the  
MAXIMUM ECONOMY  
AND EFFICIENCY

The PRINCIPLE,  
The DESIGN,  
The CONSTRUCTION,  
The OPERATION,  
The RESULT,

**Is RIGHT**

Complete installations made by "THE FIRM WITH THE EXPERIENCE."

**ERNEST SCOTT & CO.** Manufacturing  
Engineers

FALL RIVER, MASS. and G.P.O. BOX 2803, MONTREAL

SODA or SULPHATE  
**LAP-WELDED  
DIGESTERS**

Swenson Multiple Effect Black Liquor Evaporators.  
Rotary Black Ash Incinerating Furnaces.  
Complete Soda Recovery Equipment.

**SWENSON EVAPORATOR CO.**

945 MONADNOCK BLDG., CHICAGO



# Heating and Ventilating

## THE SHELDON SYSTEM

for Heating and Ventilating is better adapted than any other, because of its capacity for warming large volumes of air under high velocity.



*Heating Fan, with Vertical Enclosed, Forced Lubricating Engine, for Textile, and Pulp and Paper Mills.*

Appliances also made for Exhausting Steam, Fumes and Foul Air, Air Cooling Systems, Callander Blowers and Piping, etc.

---

**SHELDONS LIMITED**  
**GALT . . . . . ONTARIO**

Toronto Office: 609 Kent Bldg.  
 Agents: Ross & Greig, 412 St. James St., Montreal, Que.  
 Grose & Walker, 259 Stanley St., Winnipeg, Man.  
 R. Hamilton & Co., Bank of Ottawa Bldg., Vancouver, B.C.  
 Gorman, Clancey and Grindley, Calgary and Edmonton

VALLEY IRON



WORKS COMPANY

# BEATING AND WASHING ENGINES

IRON OR WOOD TUBS

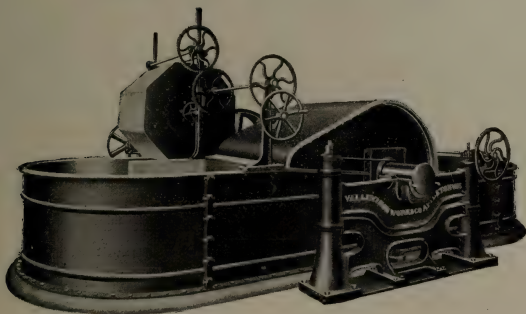

*Perfection in Every Detail*

Beating, Washing and Bleaching Engines. Barkers—Barker Attachments—  
—Chippers—Rechippers—Chip Screens (Revolving)—  
Knot Screen (Revolving)—Diaphragm Screens—Felt Washers—Deckers  
(Single and Double)—Stuff Chests (Vertical and Horizontal)—  
Tanks (Blow Off, Acid and Water)—Pulpwood Saws (Friction and  
Steam Feed)—Pulpwood Splitters (Vertical and Horizontal)—  
Shredders and Special Washers for old Paper Stock—Wet Machines and  
Patent Roll Skinners—Bronze, Semi-Steel, Lead and Iron Castings.

**Manufacturers of Paper and Pulp Making Machinery in**

*All Standard Forms — Many Special Designs*

**ENGINEERS, FOUNDERS AND MACHINISTS**

*Correspondence Invited*

**VALLEY IRON WORKS COMPANY**

**APPLETON, WIS, U.S.A**

# TOWNSEND

## ELECTROLYTIC CELL

2,500-5000 AMPERE UNITS. ALKALI AND CHLORINE.  
CAUSTIC SOJA. BLEACHING POWDER. CHLORINE  
FOR ORES. LICENSES GRANTED. CANADIAN PATENTS  
91939 - 105088 - 105089.

**HOOKER ELECTROCHEMICAL COMPANY**  
40 WALL STREET, NEW YORK

REGISTERED



JOHN KNIGHT, Pres. C. K. WILLIAMS, Treas. C. H. KNIGHT Sec.

## Paper-Makers Chemical Co.

FROM MINE TO MILL

**ENGLISH CHINA CLAYS  
MANUFACTURERS**

**Excelsior Felt Cleaner**

GBB Brand China Clay is  
a natural pure white, no artificial tinting  
Unsurpassed for  
coating, bleaching, or fine papers.

Superior Rosin Size

Superior Sat'n White

**EASTON, PA., U.S.A.**

## Paper Coating and Colouring Machines

COMPLETE PLANTS AND ACCESSORIES

The best in the world.

To be obtained from

**Julius Fischer** Engineering Works **Nordhausen, H.**

GERMANY

*Excellent References in all countries.*

**THE PETER HAY KNIFE CO., Limited, GALT, ONT.**

MACHINE  
KNIVES,  
CHIPPER,  
BARKER &  
PAPER-  
CUTTER  
KNIVES.



Made from the Best English Steel and Warranted.

# CHR. WANDEL

REUTLINGEN, - GERMANY

ESTABLISHED 1869.

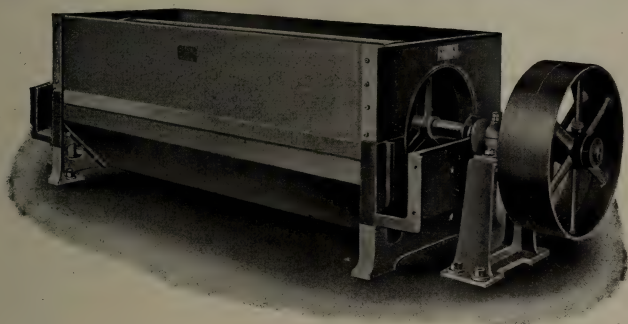

*Manufacturer of the*

## “ORIGINAL WANDEL” Rotary Sulphite Pulp Screen

Satisfactory service sure. Best by test. Beware of imitations. Largest screening surface, combined with small requirement of room. Absolutely reliable and noiseless work. No contact of the pulp with iron parts. Simple, durable, perfect. Price very moderate. The system now adopted by the most important Sulphite Fibre Mills of Europe. Estimates promptly furnished, delivered at any point.

SOLE CANADIAN AGENTS

ARTHUR P. TIPPET & CO.

8 Place Royale

Montreal, Que.

# CROOKES, ROBERTS & Co.

SHEFFIELD

ENGLAND

Makers of

Crucible Cast Steel

Bed Plates

Jordan Fillings

Beater Bars



Makers of

Bessemer Cast Steel

Crookes'

Composition

Fillings

And every description of Cutter Knives, Tools and Steel used and required in Paper Mills.

**ARGUS** High-Speed **STEEL** for fine machine tools is unsurpassed.

Once Used - Always Used

**YOU SAVE MONEY USING "ARGUS" GOODS**

WRITE US

**ARTHUR P. TIPPET & CO.**

Agents for Canada

MONTREAL

# SPENCER'S

ALWAYS



RELIABLE

Best Wool - Best Weave - Best Wear

**J. H. SPENCER & SONS**

BURY

ENGLAND

Canadian Agents: ARTHUR P. TIPPET & CO., MONTREAL



# INDEX TO ADVERTISEMENTS.

(SEE CLASSIFIED ADVERTISERS INDEX ON PAGE XXXI.)

Ambursen Hydraulic Construction Co. . . . .	lxv	Dillon Machine Co. . . . .	xiv
American Forestry Association . . . . .	liv	Dodge Mfg. Co. . . . .	iv
Appleton Machine Co. . . . .	iv	Dominion Belting Co. . . . .	xlvi
Atterbury Bros. Inc. . . . .	lxii	Eaton & Brownell . . . . .	lviii
Ashcroft Mfg. Co. . . . .	xxx	Emerson Mfg. Co. . . . .	xxv
Becker & Co. . . . .	com	Farrell Foundry & Machine Co. . . . .	xxxvii
Beloit Iron Works . . . . .	xliii	Ferguson, H. S. . . . .	lviii
Bentley & Jaeskon . . . . .	v	Fischer, Julius . . . . .	xlv
Bertram, James & Son, Ltd. . . . .	xlviii	Finckh, Hermann . . . . .	xxxix
Bertram's, Limited . . . . .	vi	Fornstedt Gustaf . . . . .	lxi
Black-Clawson Co., The . . . . .	x	Garland, M. Co. . . . .	xii
Blethen, Hugh R. . . . .	lix	Gewerkschaft, Sachtleben . . . . .	lxiii
Bredt & Co., F. . . . .	lii	Gillespie, Geo. H. Co. . . . .	lxv
Brunner, Mond & Co., Limited . . . . .	lxvi	Glens Falls Machine Works . . . . .	xlx
Caldwell, H. W. & Son, Co. . . . .	xxxii	Green Bay Barker Co. . . . .	xxi
Canada Coating Mills, Limited. . . . .	lvii	Hamelin, The, & Ayers Co., Ltd. . . . .	lx
Canada Paper Co., Ltd. . . . .	lvii	Hamilton, Wm. Co. . . . .	xxxiii
Canadian Boomer & Boschert Press Co. . . . .	lx	Hardy, Geo. F. . . . .	lviii
Canadian Boving Co. . . . .	lv	Harmon Machine Co. . . . .	viii
Carthage Machine Co. . . . .	xxiv	Hay Knife Co., Peter, Limited . . . . .	xlv
Castle, Gotthell & Overton . . . . .	lii	Holyoke Machine Co. . . . .	xvi
Chambers & Simpson . . . . .	vi	Hooker Electrochemical Co. . . . .	xlv
Chicoutimi Pulp Co. . . . .	xxvi	Horn, J. H. & Son . . . . .	xxxiii
China Clay Co. . . . .	1	Hough, R. . . . .	lxvi
Christie, J. Co. . . . .	lxvi	Howell Co., The . . . . .	xlvi
Christie, Limited, George . . . . .	lxv	Jeffrey Mfg. Co. . . . .	lii
Churchill & Sim . . . . .	lxii	Jenckes Machine Co. . . . .	xvii
Crookes, Roberts & Co. . . . .	xlvi	Johnson & Sons, Limited, C. H. . . . .	xlx
Crossley, T. L. . . . .	lviii		
Dallyn, Jardine & Co. . . . .	lii		
De Cew, J. A. . . . .	lix		

## HYDRAULIC TURBINES

One unit of six with a total capacity of 13,100 Horse Power furnished for the new plant of J. R. Booth, Ottawa, Ontario. We build Turbines for any power for heads from 3 to 600 feet.

WRITE FOR CATALOGUE



**S. MORGAN SMITH CO.,**  
 YORK - PA.

Jones, E. D. & Sons Co. ....liv  
 Jones & Glassco .....xx  
 Kimball, Herbert S. ....lviii  
 Klipstein & Co., A. ....1  
 Lawrence Machine Co. ....xx  
 Lawrence Pump & Engine Co. ....lii  
 Lea, R. S. & H. S. Ferguson ....lviii  
 Little, Arthur D. Inc. ....lviii  
 Lyford, Clark & Lyford ....lviii  
 Mallandain, Albert E. ....xxxix  
 Marx, J. & Co. ....viii  
 Mardon, Alfred H. ....lx  
 McDougall, John, Caledonian Iron Works  
 Co., Limited .....xxxv  
 Meincke, C. A. & Co. ....1  
 Milne, Jas. and Son .....e.o.m.  
 Moore & White Co. ....xv  
 National Pipe & Foundry Co., Ltd. ....1  
 New Brunswick Pulp and Paper Co.,  
 Limited .....lvf  
 Northern Crane Works, Ltd. ....lxvi  
 Panzl Digester Lining Co. ....lvi  
 Paper Makers Chemical Co. ....xliv  
 Parsons Trading Co. ....xxiv  
 Penmans Limited .....lii  
 Perkins, B. F. & Son .....xxxiv  
 Phillips, S. C. & Co. ....xxxviii  
 Porritt & Son, Joseph .....lii  
 Porritt Bros. & Austin .....xlix  
 Prather, H. B. ....lix  
 Preston's Digester Lining Co. Ltd. ....xxxvi  
 Pride, Chas. B. ....lix  
 Pringle, T. & Sons ....lviii  
 Pullan, E. ....liv  
 Pulp & Paper Trading Co., The .....xxviii  
 Reddaway, F. & Co. ....liv  
 Rice, Barton & Fales .....ii  
 Riordon Paper Co., Limited .....lvii

Rolland Paper Co., .....lvi  
 Rutherford & Pringle .....xxxiv  
 Sadler & Haworth .....liii  
 Sandy Hill Iron & Brass Works .....x  
 Scandinavian American Trading Co. ....xxix  
 Schaeffer & Budenberg Mfg. Co. ....lxiii  
 Scottish Wirecloth Co. ....xlviii  
 Scott, Ernest & Co. ....xli  
 Sheldons Ltd. ....xlii  
 Sherbrooke Machinery Co., Limited. ....xix  
 Smart-Turner Machine Co. ....lxvi  
 Smith, S. Morgan, Co. ....xlvii  
 Snell, Samuel Co. ....1  
 Spencer, J. H. & Sons .....xli  
 Stancliffe Estates Co., Ltd. ....lxiii  
 Stebbins Engineering & Mfg. Co. ....lix  
 Sweezy, R. O. & W. G. ....lviii  
 Swenson Evaporator Co. ....xli  
 Taylor, J. A. ....lxv  
 Ticonderoga Machine Works. ....xxvi  
 Tippet, Arthur P. & Co. ....xxv-xlv-xlvi  
 Union Screen Plate Co. ....iii  
 Union Sulphur Co., The .....lxi  
 United Wire Works, Limited .....xxv  
 Valley Iron Works .....xliii  
 Vera Chemical Co. ....lxlii  
 Voith, J. M. ....vii  
 Walker, J. R. & Co. ....lxii  
 Wallace, Jos. H. & Co. ....lix  
 Walmsley, Charles & Co. ....xxii-xxiii  
 Wandel, Chr. ....xlv  
 Wandel Screen Mfg. Co. ....ix  
 Watrous Engine Works Co., Ltd. ....lxv  
 Westbye, P. P. ....xi-xxxix  
 West End Engine Works Co. ....xxvii  
 Wilkinson, E. H. ....xxxix-lvi  
 Wilson-Paterson Co. ....xxiv  
 Winn & Holland .....lxvi  
 Zarembo Co. ....e.o.m.

*Scandinavian Sulphite  
 and Ground Wood  
 Kraft Pulp  
 Bleached Sulphate  
 and Sulphite  
 Austrian Bleached  
 Mitscherlich*

Limited quantities still available  
 Write us for quotations and  
 quantities

**THE HOWELL CO.**  
 8-10 Wellington St. East  
**TORONTO - CANADA**

**MAPLE LEAF**  
**STITCHED COTTON DUCK**  
**BELTING**  
**DOMINION BELTING CO. LTD.**  
**HAMILTON CANADA**

**The Scottish Wirecloth**  
 Company, Limited  
 LEITH - - - SCOTLAND

Wirecloth for Paper Machines, etc.

# Glens Falls Machine Works

GLENS FALLS, N.Y.



Sole Manufacturers of

**Tromblee & Paull Rotary Sulphur Burner**

**The Moore Rotary Screen**

**The Reynolds Screen**

Also Manufacture

**Cedar Point Foundry Grinders**

**Improved Standard Grinders**

**Improved Wet Machines**

**Rotary Pumps, etc.**

Write for Particulars and Specifications—they are free.

## C. H. JOHNSON & SONS, Ltd.

WIRE WORKS, ST. HENRY, MONTREAL.

MANUFACTURERS OF

**Fourdrinier Wires, Cylinder Wires,  
Brass, Copper and Iron Wire Cloth, Dandy Rolls**

## PORRITT BROS. & AUSTIN

Stubbins Vale Mills—RAMSBOTTOM—near Manchester, England

Manufacturers of every description of

**FELTS AND JACKETS FOR  
PULP AND PAPER MILLS**

Agents for Canada: C. H. JOHNSON & SONS, Ltd., ST. HENRY, MONTREAL

WE MANUFACTURE WOODEN WATER PIPE for Water Works Systems. SPECIALLY MADE  
PIPE for Conveying Chemicals. CONTINUOUS STAVE PIPE for Power Plants.

Sizes from 2 inches to 12 feet diameter.

**NATIONAL PIPE AND FOUNDRY CO., LIMITED**

Works, Alexandria, Ont.

135 Board of Trade Bldg., MONTREAL, Que.

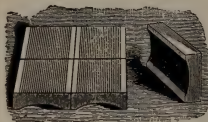

## Use Snell's Drainer Bottoms

They drain quickly and don't let the Pulp go into  
River. No Dust. No Splinters. Clean Stock.

*Send for Sample and Price*

**Samuel Snell Co., - Holyoke, Mass.**

Cable Address:—"Kaolin, Manchester." A.B.C. Codes 4th & 5th Edition

# CHINA CLAY CO.

JOHN WILLIAMSON, Manager.

4 St. Anne's Square

**MANCHESTER, ENG.**

**MINES**—Ruddle, Bojea, Colchester, South Ninestones, Tronance, St. Austen  
Cornwall.

CONTRACTORS TO H.M. INDIAN GOVERNMENT

Canadian Representatives—C. A. Meincke & Co., 222 Coristine Bldg., Montreal.

## A. KLIPSTEIN & Co. Ltd.

(OF CANADA)

12 ST. PETER ST.

MONTREAL

# SULPHATE ALUMINA

**CHINA CLAY, BLEACH and CASEIN  
PAPER BLUE, both Basic and Acid  
AURAMINE - RHODAMINE**

and all other Aniline Colors

Shades Carefully Matched in our Laboratory

Mention Pulp & Paper  
Magazine

New York Office - 644-654 Greenwich Street.

TELEGRAMS }  
CABLEGRAMS } MILNE, EDINBURGH

Code A B C 4th & 5th Editions.

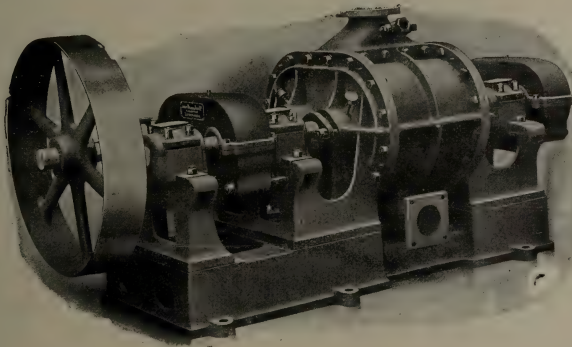

# HIGH DISPLACEMENT VACUUM PUMP

*(Made in Various Sizes)*

Suitable for

SUCTION ROLLS or VACUUM BOXES

MANUFACTURED BY

**JAMES MILNE & SON, LIMITED**

MILTON HOUSE WORKS, EDINBURGH

DESIGNERS  
AND  
MANUFACTURERS  
OF HIGH CLASS  
PAPER MILL  
MACHINERY

FAST RUNNING  
PAPER MILL  
MACHINERY  
A SPECIALTY  
LEAST VIBRATION  
LEAST BREAKAGES

*Don't Touch Your Mill Equipment Without Trying Milne.*



**LAWRENCE PUMP AND ENGINE CO.**

P. O. BOX 70, DEPT. 10  
LAWRENCE :: MASS.

**CENTRIFUGAL PUMPS**

We make an exclusive specialty of High Efficiency Centrifugal Pumps for Paper and Pulp Mill. In one mill 49 of our Pumps are running, the customer writes—"Your Pumps are all giving perfect satisfaction."



ESTABLISHED 1808.

REGISTERED.

TRADE MARK.

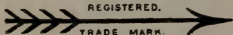

**FELTS** For Pulp and Paper Mills.

**JOSEPH PORRITT & SONS**

**HELMSHORE**

Manchester, England.

Agents for  
Canada  
and United  
States.

All kinds  
Woollen, Lin-  
en and Cotton  
Cloths for  
Mechanical  
Purposes.

**F. BREDT & CO., 240 Water Street, NEW YORK.**

**PENMANS LIMITED**

ST. HYACINTHE, QUEBEC

Manufacturers of

**PULP AND PAPER MAKERS' FELTS,  
JACKETS, STRAINER CLOTHS, ETC.**

Special sizes and qualities made to order. Satisfaction guaranteed.

**DALLYN, JARDINE & CO. TORONTO Selling Agents**

**CASTLE, GOTTHEIL & OVERTON**

*200 Fifth Avenue, New York*

AGENTS FOR

***Sulphite and Wood Pulp Mills***

Dealers in all kinds of Paperstock, Sizing, etc.

Correspondence Solicited.

# "AMPHIBIA"

WATERPROOF

## Leather Belting

Costs

Less

Per Day

of

Service

This means that it is the least expensive belting you can buy irrespective of the cost price per foot



*Sadler & Haworth*

Tanners and Manufacturers

MONTREAL TORONTO

ST. JOHN, N.B. WINNIPEG VANCOUVER

For over thirty-five years the makers of  
the best leather belts

Nearly FIFTY YEARS ago we introduced this Belt. IT HAS STOOD THE TEST OF TIME  
2" to 24" in stock

Every Belt is  
Stamped with  
Trade-Mark.



Write or phone us

Beware  
of Imitations

SOLE MAKERS

F. REDDAWAY & CO.,

MONTREAL, CANADA.

**E. PULLAN,** 490 Adelaide St. W.,  
TORONTO

Largest Paper Stock Dealer in Canada

**RAGS AND PAPER STOCK GRADED TO SUIT MILL REQUIREMENTS**

Correspondence Solicited.

EDWARD A. JONES, President and Treasurer

WALLACE E. BARDWELL, Secretary

**E. D. JONES & SONS CO.,** Pittsfield, Mass.

Manufacturers of

**PAPER MAKING MACHINERY  
AND MECHANICAL ENGINEERS**

Beating Engines. Washing Engines. Mixing Engines. Bleaching Engines.  
Cooking Engines. Vertical and Horizontal Stuff Chests.

Jordan Engines of three sizes, either belt or direct connected motor driven;  
fillings of Wagg Steel or stone type, three-part or plain.

Dusting Machinery of all kinds.

*People who are wise Advocate Forestry*

# The American Forestry Magazine

IS DEVOTED TO SECURING

Better Fire Protection

Fair Forest Taxation

Lower Freight Rates

Proper Legislation

Conservative Management

and Reforestation

It should be on the desk of every progressive American  
citizen. It is the public service publication of the  
American Forestry Association

AMERICAN FORESTRY MAGAZINE, ONE YEAR - \$2.00

Membership in American Forestry Association, One Year - \$1.00

Address **AMERICAN FORESTRY ASSOCIATION**  
Washington, D.C.

# "C.B.C." REFINER

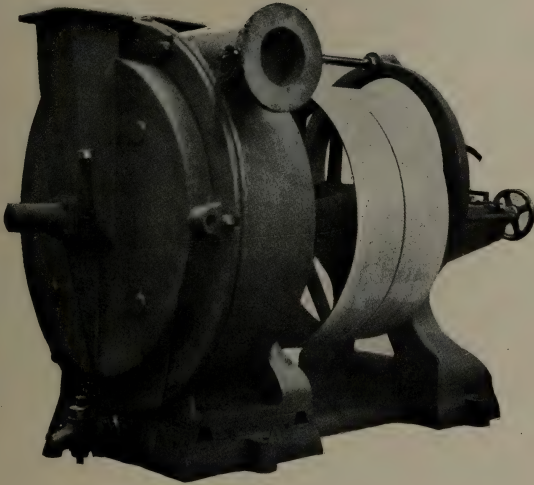

*Great strength and durability.*

*Large working capacity.*

**IT SAVES YOU ALL YOUR SCREENINGS**  
i.e., 5 to 10 per cent. of your wood consumption  
**IT INCREASES YOUR PRODUCTION**  
5 to 10 per cent. without additional power

## The Canadian Böving Co., Limited

164 BAY ST.                    -                    -                    TORONTO

VANCOUVER OFFICE        -                    -                    448 SEYMOUR ST.

## ROLLAND'S PAPERS

For Business Stationery, for Loose Leaf Sheets and all kinds of printed or lithographed forms, include many textures at a wide price range. There is a paper for every need and fancy. Ask your printer to show you our sample books, or write to us for them.

Made in White, Azure and Buff. Envelopes to match all lines.

### THE ROLLAND PAPER COMPANY LIMITED

GENERAL OFFICES - MONTREAL, P.Q.  
MILLS AT ST. JEROME AND MONT ROLLAND, P.Q.

## GENUINE "KRAFT" PAPERS

*Made in Canada*

### THE NEW BRUNSWICK PULP & PAPER CO.

Springfield Mills, Millerton, N.B. Limited

Ontario Representative - E. H. WILKINSON

Telephone Building, 82 Adelaide Street West - TORONTO

## PANZL'S PATENTED LINING COMPOSITION

IS THE SAFEST AND BEST MATERIAL FOR  
LINING OF SULPHITE PULP DIGESTERS

AND ACID RECLAIMING TANKS

**PANZL LININGS ARE SAFEST AND  
MOST DURABLE**

They are really acid-proof and practically indestructible.

All Digesters lined with Panzl's patented composition, now as tight and in as good condition after years of continuous use as they ever were, no leaks no repairs.

Panzl Linings can be made considerably thinner than the other linings, thus increasing the capacity of the digesters.

The composition and the system of constructing of Panzl Linings are patented in all countries where wood pulp is being manufactured by the sulphite process. **The PANZL U.S. Patents have been adjudicated to be valid in law and wholly independent of all prior patents relating to linings of digesters.**

For information and estimates, address:-

### PANZL DIGESTER LINING COMPANY

505 Washington Ave.

Muskegon, Mich.



## The Riordon Paper Company, Limited Fibre, Paper, Lumber.

MONTREAL - CANADA

News Paper, Hanging Paper, Wrapping Paper, Building Paper,  
Celebrated "Impervious" Spruce Sheathing and Sulphite Fibre for all  
kinds of Paper.

## Barber Paper and Coating Mills Ltd. GEORGETOWN, ONT.



Manufacturers of  
SURFACE COATED BOOK and LITHOGRAPHIC  
PAPERS, COATED CARDBOARD and COATED  
BOXBOARDS of every description.

### "Chalk White" Coated Book Paper.

The best and whitest coated paper sold.

**ALL REGULAR SIZES AND WEIGHTS IN STOCK.**

Our Art Litho Cover Paper is stocked in four tints,  
2 sizes. 20x25 and 21½x28½. Samples gladly sent.

MONTREAL  
TORONTO

**CANADA PAPER CO.** WINDSOR  
LIMITED MILLS, P.O.

# DIRECTORY

of

## Civil and Chemical Engineers

### T. PRINGLE & SON, Limited

Engineers and Architects

Plans and Specifications for Pulp and Paper Mills, Power Plants and other Industrial Works.

**Coristine Bldg.**                      **Continental Life Bldg.**  
**Montreal.**                              **Toronto.**

Bell Tel.: M. 3890.

Tel.: M. 5917.

### R. S. LEA, and H. S. FERGUSON,

ENGINEERS

Pulp, Paper and Chemical Fibre Mills.  
 Water Power Development and Trans-  
 mission. Steam Power Plants.  
 Telephone Long Distance U.S. 751.  
 820 New Birks Bldg., MONTREAL

### Arthur D. Little Inc.

— LABORATORY OF —  
 ENGINEERING CHEMISTRY

93 BROAD ST., BOSTON, - MASS.

Our staff includes experts in Papermaking Chemistry  
 —Sulphite Mill Practice—Fuel Engineering.

### GEORGE F. HARDY, M. AM. SOC., M. E., M. CAN. SOC. C. E.

Consulting Engineer.

Paper, Pulp and Fibre Mills, Examination of  
 Mill Properties, Water Power Developments.  
 Mutual Reserve Building, - 309 Broadway,  
 NEW YORK.

CHARLES E. EATON,                      JAMES P. BROWNELL,  
M. Am. Soc., M. E.                              C. E.

### EATON & BROWNELL, Consulting Engineers and Architects.

Paper, Pulp and Fibre Mills, Water, Steam and  
 Electric Power Development, Examination of  
 Properties, Consultation Reports

SMITH BLDG.                      WATERTOWN, N. Y.

### A. V. TRACY-GOULD

Pulp and Paper Mills.                      Power Plants.  
 Waterworks and Sewerage,  
 Examinations.                      Reports and Surveys.

512 New Birks' Bldg., Montreal, P.Q.  
 Telephone: Uptown 6974.

### T. LINSEY CROSSLEY

*Engineering Chemist*

PULP AND PAPER  
 TECHNOLOGY

318 LaGauchetiere St., W., Montreal

### R. O. & W. G. SWEEZEY

— Civil and —  
 Forest Engineers

Limit cruising, surveys, water storage,  
 power, lumbering contracts.

MEIROPCLITAN BLDG., QUEBEC

ASSOCIATED WITH

### HERBERT S. KIMBALL

M. Am. Soc. C. E.

Mill Architect and Engineer

111 Devonshire St., Boston

ENGINEERS SHOULD WRITE  
 THE PUBLISHERS FOR RATE  
 OF CARDS ON THIS PAGE

**PULP  
PAPER  
POWER** JOSEPH H. WALLACE & CO.  
INDUSTRIAL ENGINEERS.  
TEMPLE COURT BLDG. NEW YORK.  
SALISBURY HOUSE, LONDON, E.C  
CABLES, TRIPLEX, N. Y., TRIPLEX IS, LONDON.

**C. B. PRIDE**  
MILL ARCHITECT & ENGINEER  
PAPER, FIBER, AND PULP MILLS,  
WATER & STEAM POWER DEVELOPMENT  
25 YEARS SUCCESSFUL OPERATIONS  
SPOKANE, WASH OFFICES APPLETON, WIS.

**J. A. De CEW** M.A. INST. CHEM. ENG. *Chemical Engineer*  
A.M. CAN. SOC. C.E.  
Paper Mill Analysis Pulp Testing Investigations  
Sulphite Fibre, Soda Fibre Reports  
CANADIAN EXPRESS BUILDING MONTREAL

Power, Lighting, Heating, Ventilating and Drying.—Complete New Plants, Improvement of Old Plants;  
Plans, Specifications, Contracts, Estimates, Tests, Appraisals, Inspections and Reports.—Pulp, Paper,  
Box Board and Coating Mills.

Lowest **H. B. PRATHER,** Guaranteed  
Possible *CONSULTING ENGINEER,* Results.  
Operating Cost. ROCKFELLER BLDG., CLEVELAND, O.

**HUGH R. BLETHEN**  
21 PARK ROW, - - - NEW YORK, N.Y.  
Traveling Cranes - Overhead Tramways - Trolleys and Chain  
Hoists for Paper and Pulp Mills - Power Houses.

**Stebbins Engineering & Mfg. Co.**  
WATERTOWN, N. Y.

MANUFACTURERS OF  
STEBBINS' ACID SYSTEMS, SULPHUR BURNER  
DIGESTER LININGS, RECLAIMERS, ETC.  
Engineering Department Plans, Estimates and Specifications for Paper,  
under Pulp and Fibre Mills,  
Mr. T. L. TOMLINES Water Power and Hydro-Electric Developments

# LEUNIG PAPER SCALES

Showing correctly at a glance, by weighing a single sheet, the weight of a ream of Paper of any size, containing either 480, 500, or 516 sheets.

Can also be made to indicate in addition to the English weight, the weight in Kilogrammes.

Illustrated Price List on Application.

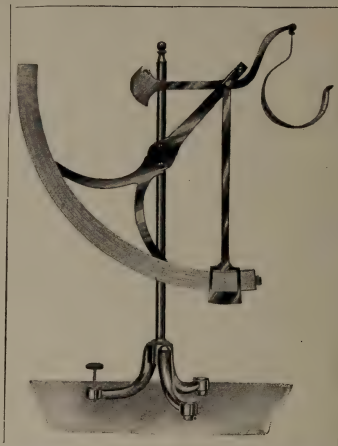

$\frac{1}{2}$  to 80 lbs.

**Price,**  
**Ten Dollars**  
F.O.B., London

$\frac{1}{2}$  to 120 lbs.

**Price,**  
**Fourteen Dollars**  
F.O.B., London

Illustrated Price List on Application.

**Alfred H. Mardon** 150 Shaftesbury Ave. **London, Eng.**

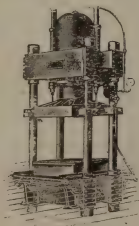

# PULP PRESSES

AND ACCESSORIES

CANADIAN BOOMER & BOSCHERT PRESS  
COMPANY, LIMITED

18 TANSLEY STREET, MONTREAL

"LACHUTE FELTS" Bell Tel. No. 23

# The Hamelin & Ayers Co., Limited

LACHUTE MILLS, P.Q.

MANUFACTURERS OF EVERY DESCRIPTION OF

# FELTS FOR PAPER AND PULP MILLS

"The Best are the Cheapest."

# Every Papermill



*must have a daylight lamp.*

**“HELIA”**

*is a real daylight lamp,*

*strong, cheap and economical. By the aid of “Helia,” every graduation of color can be exactly determined with the same precision as in daylight.*

---

---

*Sole Agency in Canada and U.S.*

**GUSTAF FORNSTEDT**

**THREE RIVERS - - QUE**

# The Union Sulphur Company

**Producers of the Highest Grade Brimstone on the Market**

---

**Absolutely free from Arsenic, Selenium or Tellurium**

---

**The Largest Sulphur Mine in the World**

**CALCASIEU PARISH, - LOUISIANA**

**Main Offices : Whitehall Bldg., 17 Battery Place  
NEW YORK**



## WE GUARANTEE OUR SIZINGS TO BE ABSOLUTELY CLEAN OUR VERA PAPER SIZE

is purest, strongest and highest free rosin size made. We can furnish you with an ideal rosin size and patented apparatus to use same.

### OUR VERA MILL SIZE

is the best soluble paper makers' rosin size made. Ready to use in cold or warm water in the ordinary way without apparatus. Gives better satisfaction and is more economical than mill made size.

Our sizings are cleaned by our new patented process and we guarantee this size to be absolutely clean, without the least speck of impurity in the same, preventing thereby black specks in the paper. We are shipping our size in barrels or tank-cars.

## VERA CHEMICAL COMPANY

Main Office and Western Factory  
NORTH MILWAUKEE, WIS.

Eastern Factory  
STONEHAM, MASS.

**J. R. Walker & Co.** Importers and Packers of **GRADED RAGS, PAPER STOCK  
ROPE BAGGING, ETC.**

WAREHOUSE, 35 COMMON ST., MONTREAL.

Also Manufacturers of Roofing and Building Papers. Leatherboard and Friction Board

Mills at Sault au Recollet, P.Q.

## ATTERBURY BROTHERS, Incorporated.

*Importers and Exporters.*

# Wood Pulp, FOREIGN AND DOMESTIC Rags AND Paper Stock

Potter Building, 145 Nassau Street, New York City.

Cable address "AFFECTIVE," New York.

# CHURCHILL & SIM

29 CLEMENTS LANE, LONDON, E.C.

And at Manchester

## WOOD PULP AGENTS

Telegraphic Address:—  
"CHURCHILL, LONDON."

A.B.C. CODE  
5th Edition

# The "Columbia" Recording Thermometer

Mercury actuated, therefore absolutely accurate and reliable  
 Mechanism entirely of steel, resulting in an exceptionally  
 rugged construction enabling it to last much longer than other recorders  
 Charts are uniformly graduated with the night and day border

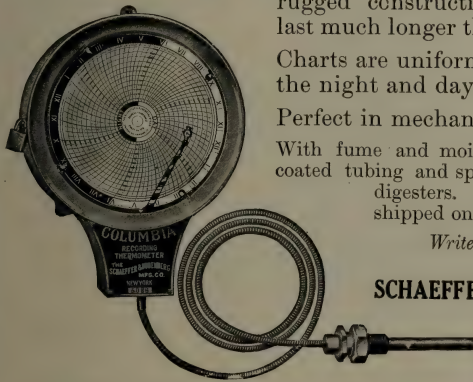

Perfect in mechanical detail  
 With fume and moisture proof case, lead coated tubing and special bulb for sulphite digesters. Fully guaranteed and shipped on approval

Write for Catalog 628

THE  
**SCHAEFFER & BUDENBERG**  
**MFG. CO.**

BROOKLYN, N.Y.  
 Chicago Pittsburgh

## GEWERKSCHAFT SACTLEBEN

Homberg-Niederrhein, GERMANY

Largest Makers  
of all Qualities

# BLANC FIXE

Three  
Varieties

Bright, Matt or Dull  
Photographic

## THE STANCLIFFE ESTATES CO. LTD.

DARLEY DALE - - - ENGLAND

J. H. DAWSON, Man. Dir.

**BEST ENGLISH  
PULP STONES**

from our celebrated Darley Dale Quarries  
as supplied to the Canadian Market  
Prices and particulars on application

Liebers Code Used

Telegraphic Address, "Stancliffe," Twodales, England

---

---

# Waterous Cylinder Moulds

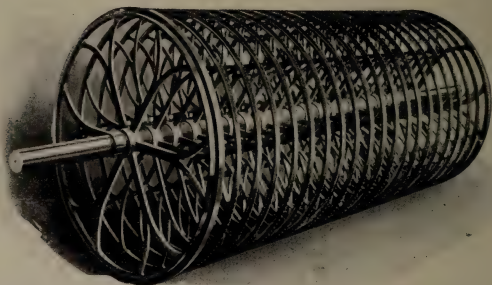

**Moulds that will remain tight and true  
until worn out—**

Waterous brass cylinder moulds are made in practically all diameters up to 48 in., and in any length.

Have a through-going shaft of steel of extra large diameter; brass spiders of special design, light and strong, and absolutely rigid.

Moulds are covered by a special process; supporting wire is wound and so inset in supporting rods that it cannot slip. Both wire cloths are sewn on by hand—not soldered.

We have a separate department with special machinery and appliances for turning out these moulds as they should be.

Special Moulds for special purposes to order.

—WRITE US FOR PRICES AND DELIVERY—

**The Waterous Engine Works Co.,**

BRANTFORD

CANADA

LIMITED

---

---

**Geo. Christie Ltd.**

**Glasgow  
Scotland**

**FOURDRINIER MACHINE WIRES**

**Unequalled for Strength, Smoothness and Long Life**

**CYLINDER COVERS**

**Canadian Agent :**

**J. A. Taylor, 22 St. Francois Xavier St., Montreal**

**CANADIAN TALC FILLER**

**GEO. H. GILLESPIE COMPANY**

**MADOC - - - ONTARIO**

*The only Manufacturers of Paper Filler in Canada.*

Our Filler is used in Canada, United States, England, Germany, Austria, Holland, Russia and Scandinavia.

**AMBURSEN HYDRAULIC CONSTRUCTION CO.,**

**OF CANADA, LIMITED**

**822 New Birks Building - MONTREAL**

*Associated with the Ambursen Hydraulic Construction Co., of Boston, Mass.*



**Concrete Steel Dam**

OF THE

**MISSISQUOI PULP CO.,**

**Sheldon, Springs, Vt:**

Mid-channel, height 49 feet.  
Total length 270 feet (only 180 feet shows in the picture, the remainder being concealed at the left.)

Dam specially designed to withstand heavy ice gorges.

Factors of safety, are calculated for a 12-foot flood.

**IF YOU HAVE A DAM TO BUILD, WRITE US NOW.**

Every Grade of Waste for  
Paper Making.

# R. HOUGH

LONDON, England.

Agent for Canada and U.S.,

**THE J. CHRISTIE CO.**

5 King St. West, TORONTO, Canada.

STEAM PUMPS  
CONDENSERS  
VACUUM PUMPS  
TRIPLEX POWER PUMPS  
CENTRIFUGAL PUMPS

**The Smart-Turner  
Machine Co., Limited**

HAMILTON . . . . . CANADA

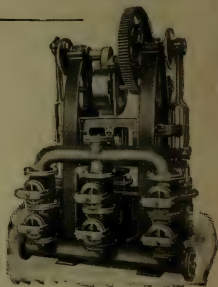

**CRANES AND ELECTRIC HOISTS**

Made in Canada

**NORTHERN CRANE WORKS LTD.**

WALKERVILLE . . . . . ONTARIO

Complete Overhead Track Systems

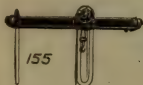

**HIGH  
TEST**

# BLEACHING POWDER

35/38%

(BRUNNER MOND & CO'S.)

**THE STRONGEST AND THEREFORE THE CHEAPEST**

**WINN & HOLLAND, Limited, MONTREAL**



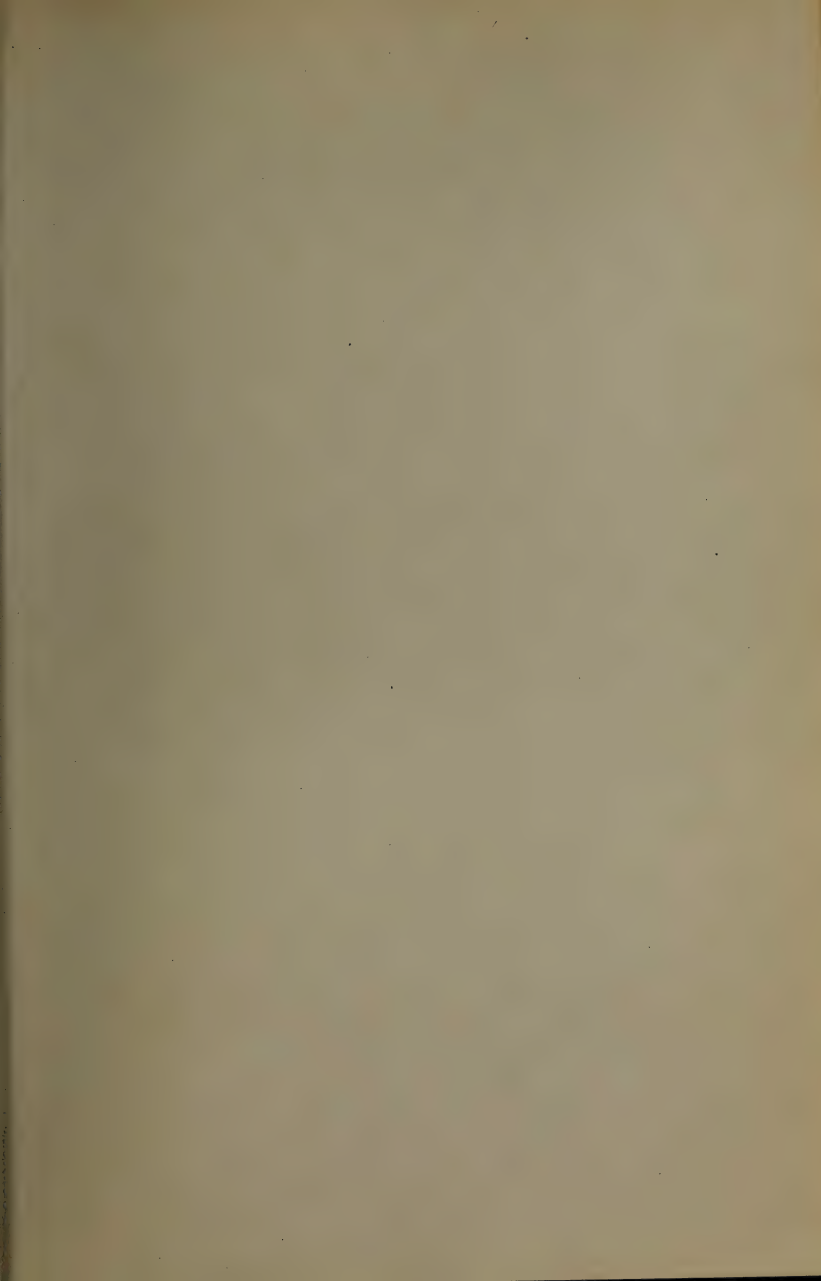

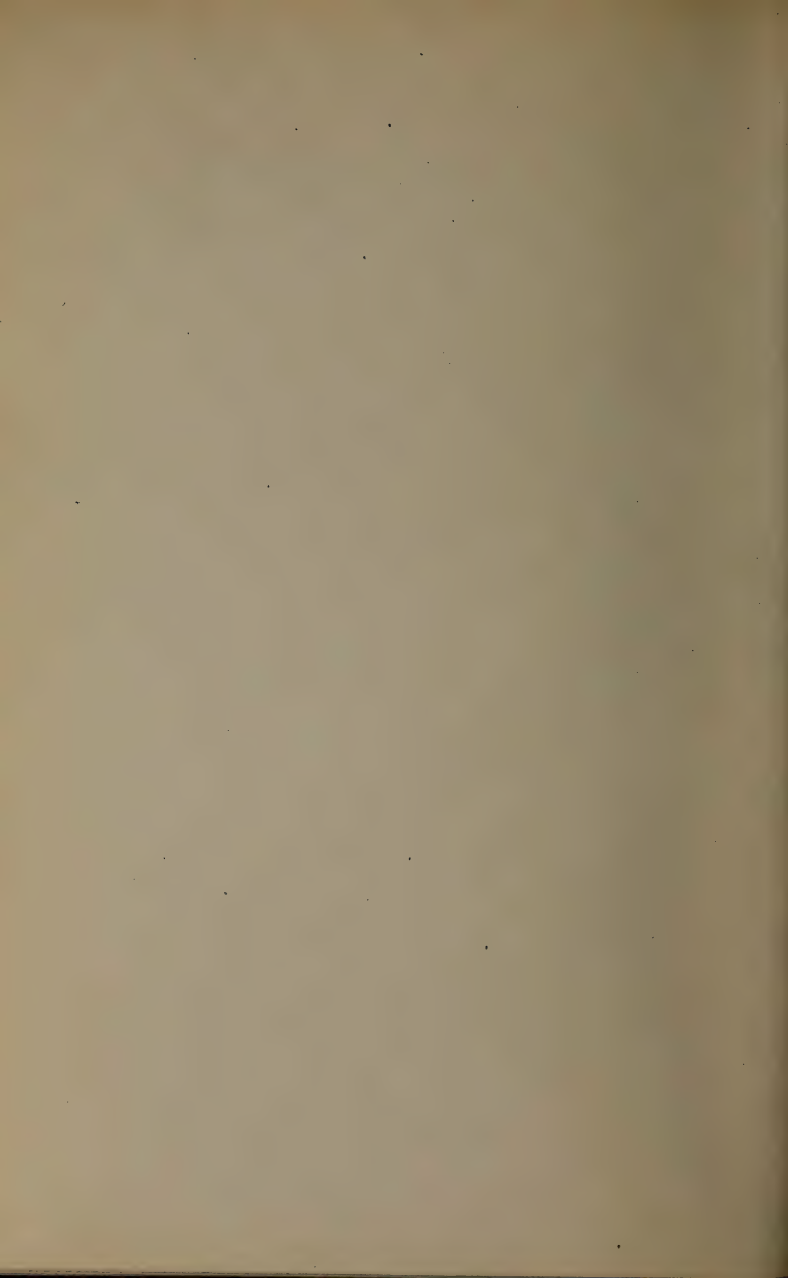

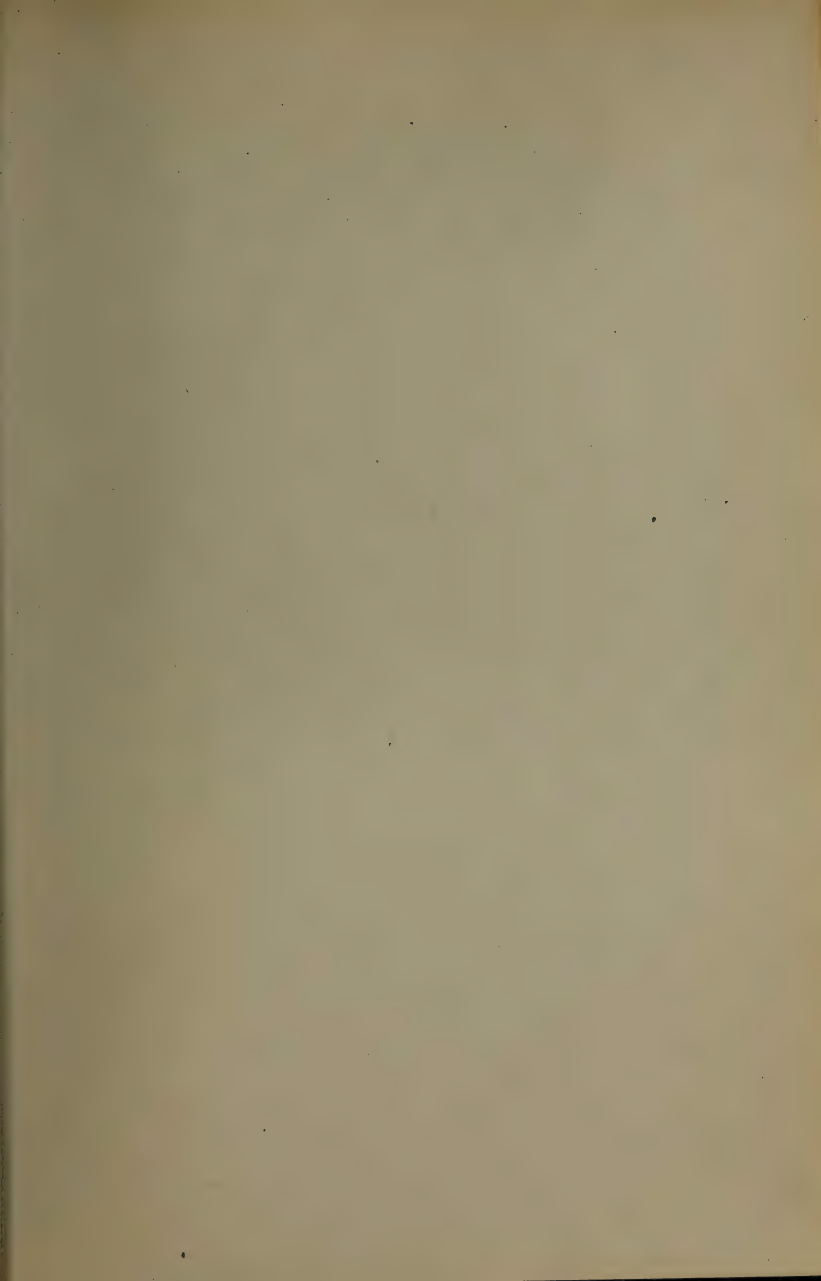

91







